

1. Package Information

Package Name	DIP16
Type	DIP
Pin Count	16
Outline Dimension	A0784
Drawing No.	
Package Weight [g]	1.1
Lead Finish	Pure Tin
MSL Level	Level1

2. Package Structure

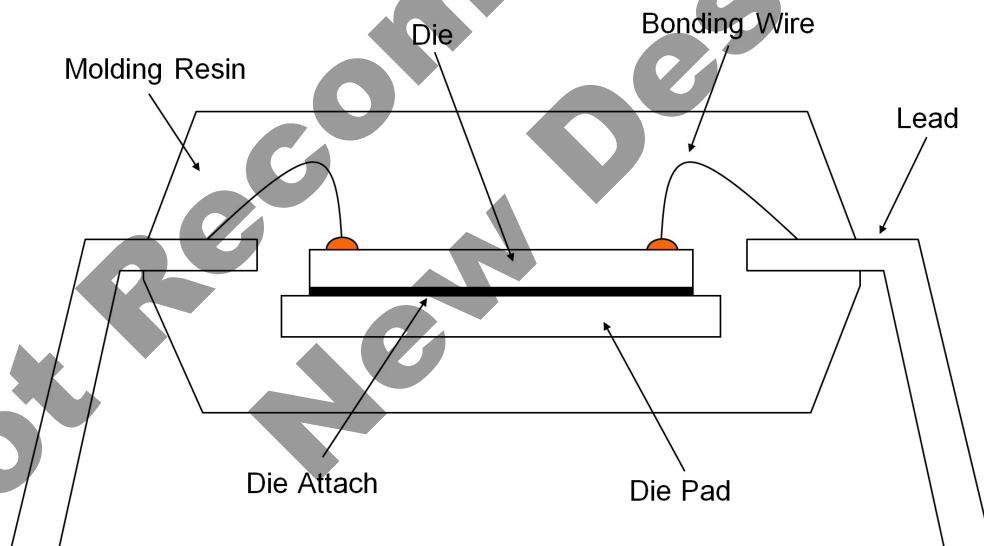

3. Packing Specification

3.1 Packing form, Quantity

Packing Form		Tube
Packing Quantity	[pcs]	25

3.2 Use material

Item	Material
Tube	PVC
Stopper	PVC
Unit box	Cardboard
Shipping box	Cardboard

Not Recommended for
New Designs

3.3 Tube Specification
 3.3.1 Tube Dimension

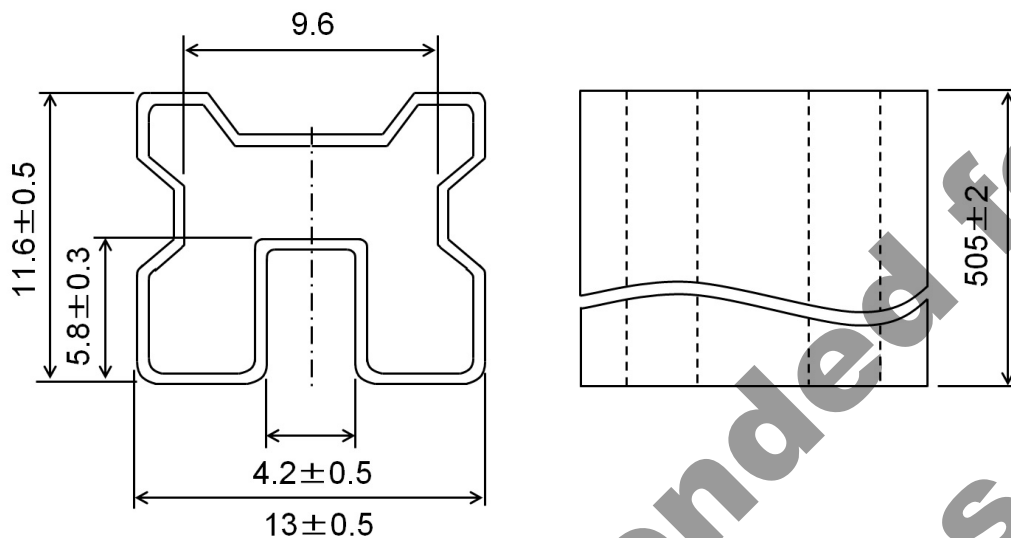

(unit:mm)

Not Recommended for New Designs

3.4 Packing Method

40 tube(s) or less per unit box

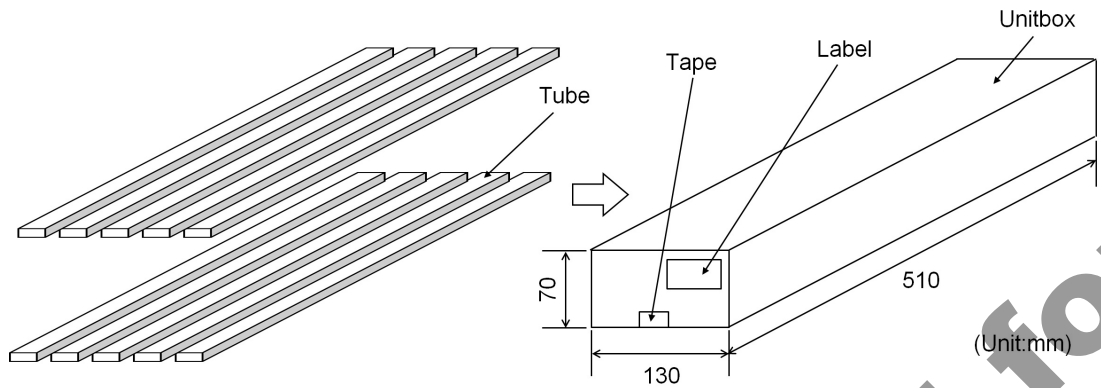

3.9 Packing Style

3 unit boxes or less per shipping box

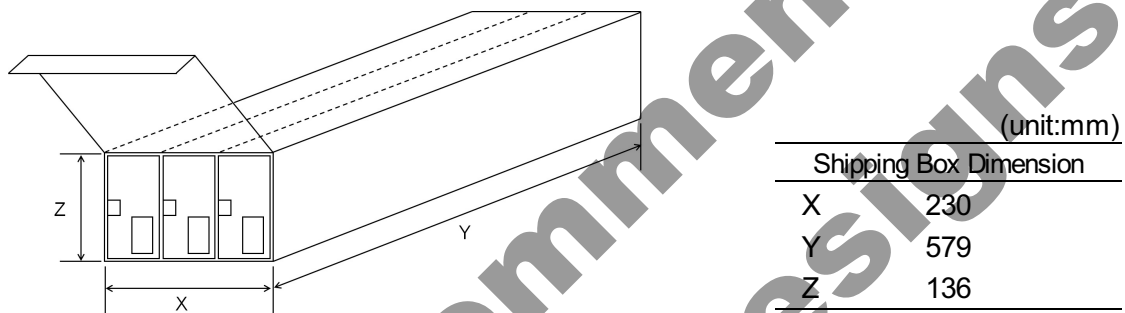

3.10 Label Specification



4. Footprint dimensions

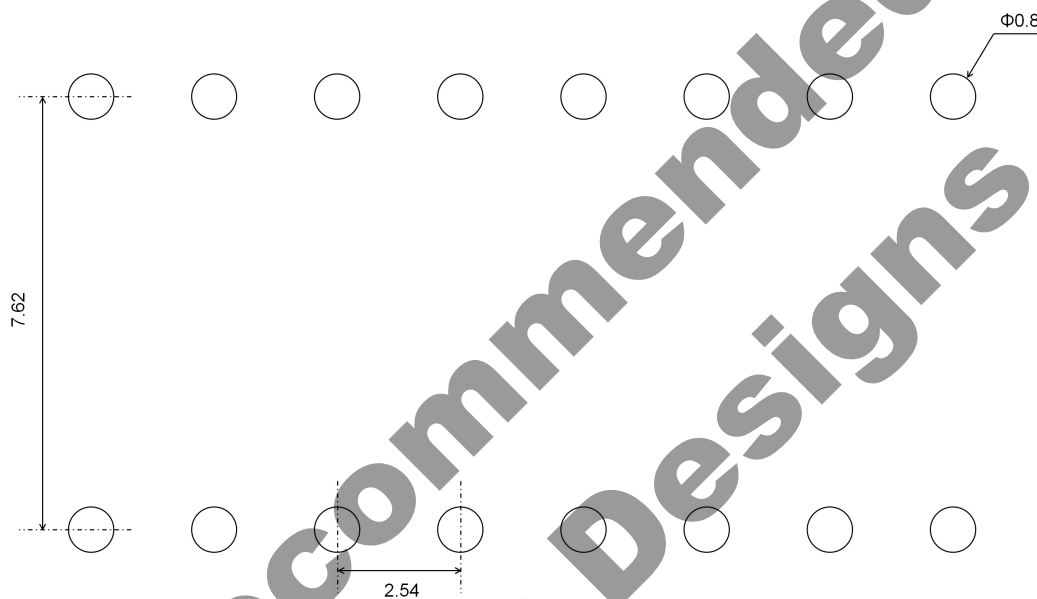

(unit:mm)

In actual design, please optimize in accordance with the situation of your board design and soldering condition.

5. Marking Specification

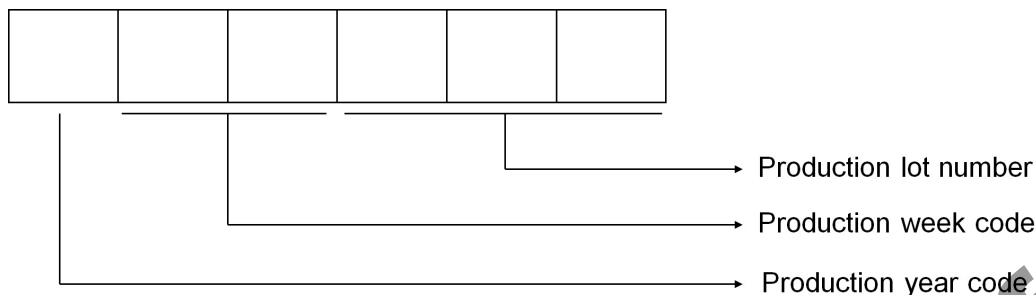

6. Storage conditions

6.1 Storage environment

Recommended storage conditions

	Min.	Max.	Unit
Temperature	5	30	°C
Humidity	40	70	% RH

6.2 Storage period

	Min.	Max.	Unit
Storage period	-	1	year

7. Soldering conditions

7.1 Recommended condition for wave soldering

Preheating temperature	:	120 °C to 150 °C
Preheating time	:	60 sec MAX
Soldering temperature	:	260 °C ± 3 °C
Soldering time	:	12 sec MAX

Notes for wave soldering

- (1) Soldering time is provided for total soldering time in case of dual wave soldering.
- (2) Do not use other soldering methods with wave soldering.
- (3) Recommend to clean the board to eliminate flux, solder waste, and other impurities for reliability, after soldering.
- (4) Optimize soldering condition to prevent solder bridging.

7.2 Recommended condition for solder iron

Solder iron temperature	:	380 °C or less
Mounting time	:	4 sec or less

Notes

- 1) The information contained herein is subject to change without notice.
- 2) Before you use our Products, please contact our sales representative and verify the latest specifications :
- 3) Although ROHM is continuously working to improve product reliability and quality, semiconductors can break down and malfunction due to various factors.
Therefore, in order to prevent personal injury or fire arising from failure, please take safety measures such as complying with the derating characteristics, implementing redundant and fire prevention designs, and utilizing backups and fail-safe procedures. ROHM shall have no responsibility for any damages arising out of the use of our Products beyond the rating specified by ROHM.
- 4) Examples of application circuits, circuit constants and any other information contained herein are provided only to illustrate the standard usage and operations of the Products. The peripheral conditions must be taken into account when designing circuits for mass production.
- 5) The technical information specified herein is intended only to show the typical functions of and examples of application circuits for the Products. ROHM does not grant you, explicitly or implicitly, any license to use or exercise intellectual property or other rights held by ROHM or any other parties. ROHM shall have no responsibility whatsoever for any dispute arising out of the use of such technical information.
- 6) The Products are intended for use in general electronic equipment (i.e. AV/OA devices, communication, consumer systems, gaming/entertainment sets) as well as the applications indicated in this document.
- 7) The Products specified in this document are not designed to be radiation tolerant.
- 8) For use of our Products in applications requiring a high degree of reliability (as exemplified below), please contact and consult with a ROHM representative : transportation equipment (i.e. cars, ships, trains), primary communication equipment, traffic lights, fire/crime prevention, safety equipment, medical systems, servers, solar cells, and power transmission systems.
- 9) Do not use our Products in applications requiring extremely high reliability, such as aerospace equipment, nuclear power control systems, and submarine repeaters.
- 10) ROHM shall have no responsibility for any damages or injury arising from non-compliance with the recommended usage conditions and specifications contained herein.
- 11) ROHM has used reasonable care to ensure the accuracy of the information contained in this document. However, ROHM does not warrant that such information is error-free, and ROHM shall have no responsibility for any damages arising from any inaccuracy or misprint of such information.
- 12) Please use the Products in accordance with any applicable environmental laws and regulations, such as the RoHS Directive. For more details, including RoHS compatibility, please contact a ROHM sales office. ROHM shall have no responsibility for any damages or losses resulting from non-compliance with any applicable laws or regulations.
- 13) When providing our Products and technologies contained in this document to other countries, you must abide by the procedures and provisions stipulated in all applicable export laws and regulations, including without limitation the US Export Administration Regulations and the Foreign Exchange and Foreign Trade Act.
- 14) This document, in part or in whole, may not be reprinted or reproduced without prior consent of ROHM.



Thank you for your accessing to ROHM product informations.
More detail product informations and catalogs are available, please contact us.

ROHM Customer Support System

<http://www.rohm.com/contact/>