

## ZXLD1350 30V 350mA LED DRIVER with AEC-Q100

### Description

The ZXLD1350 is a hysteretic mode inductive step-down converter with integrated switch and high side current sense.

It operates from an input supply from 7V to 30V driving single or multiple series connected LEDs efficiently external adjustable output current up to 350mA.

The ZXLD1350 has been qualified to AECQ100 grade 2 allowing it to operate at ambient temperatures from -40 to 105°C.

The output current can be adjusted by applying a DC voltage or a PWM waveform. 100:1 adjustment of output current is possible using PWM control. Applying a voltage of 0.2V or lower to the ADJ pin turns the output off and switches the device into a low current standby state.

### Pin Assignments

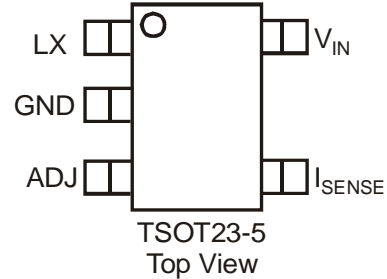

### Features

- Simple low parts count
- Internal 30V NDMOS switch
- Internal PWM filter
- High efficiency (up to 95% (Note 1))
- Wide input voltage range: 7V to 30V
- 40V transient capability
- Up to 1MHz switching frequency
- Typical 4% output current accuracy
- **Qualified to AEC-Q100 Grade 2**
- Available in "Green" Molding Compound (No Br, Sb)
- Lead Free Finish/ RoHS Compliant (Note 2)

### Typical Application Circuit

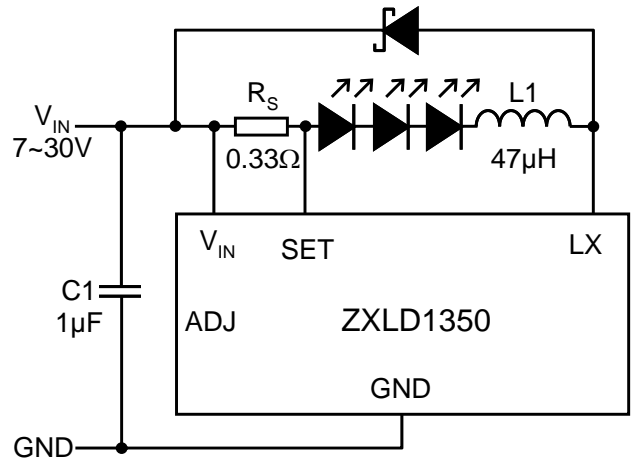

- Notes:
1. Using standard external components as specified under electrical characteristics. Efficiency is dependent upon the number of LEDs driven and on external component types and values.
  2. EU Directive 2002/95/EC (RoHS). All applicable RoHS exemptions applied. Please visit our website at: [http://www.diodes.com/products/lead\\_free.html](http://www.diodes.com/products/lead_free.html)

**Block Diagram**

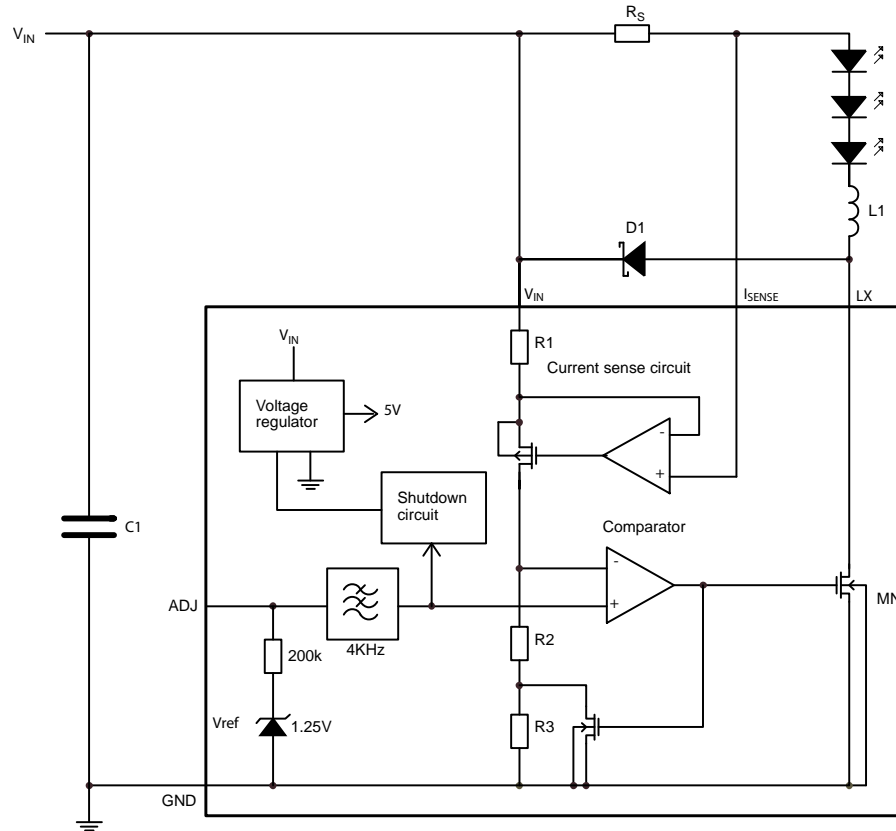

**Figure 1. Block diagram – Pin Connection**

**Pin Description**

| Name        | Pin No. | Description  |
|-------------|---------|--|
| LX          | 1       | Drain of NDMOS switch  |
| GND         | 2       | Ground (0V)  |
| ADJ         | 3       | Multi-function On/Off and brightness control pin: <ul style="list-style-type: none"> <li>• Leave floating for normal operation. (<math>V_{ADJ} = V_{REF} = 1.25V</math> giving nominal average output current <math>I_{OUTnom} = 0.1/R_S</math>)</li> <li>• Drive to voltage below 0.2V to turn off output current</li> <li>• Drive with DC voltage (<math>0.3V &lt; V_{ADJ} &lt; 2.5V</math>) to adjust output current from 25% to 200%<sup>(†)</sup> of <math>I_{OUTnom}</math></li> <li>• Drive with PWM signal from open-collector or open-drain transistor, to adjust output current. Adjustment range 25% to 100% of <math>I_{OUTnom}</math> for <math>f &gt; 10kHz</math> and 1% to 100% of <math>I_{OUTnom}</math> for <math>f &lt; 500Hz</math></li> <li>• Connect a capacitor from this pin to ground to increase soft-start time. (Default soft-start time = 0.5ms. Additional soft-start time is approx. <math>0.5ms/nF</math>)</li> </ul> |
| $I_{SENSE}$ | 4       | Connect resistor $R_S$ from this to $V_{IN}$ to define nominal average output current $I_{OUTnom} = 0.1/R_S$ (Note: $R_{Smin} = 0.27V$ with ADJ pin open circuit)  |
| $V_{IN}$    | 5       | Input voltage (7V to 30V). Decouple to ground with $1\mu F$ of higher X7R ceramic capacitor close to device  |

**ZXLD1350**  
**30V 350mA LED DRIVER with AEC-Q100**

**Absolute Maximum Ratings** (Voltages to GND Unless Otherwise Stated)

| Symbol       | Parameter  | Rating   | Unit |
|--------------|--|--|------|
| $V_{IN}$     | Input Voltage  | -0.3 to +30<br>(40V for 0.5 sec)                   | V    |
| $V_{SENSE}$  | $I_{SENSE}$ Voltage  | +0.3 to -5<br>(measured with respect to $V_{IN}$ ) | V    |
| $V_{LX}$     | LX Output Voltage  | -0.3 to +30<br>(40V for 0.5 sec)                   | V    |
| $V_{ADJ}$    | Adjust Pin Input Voltage   | -0.3 to +6   | V    |
| $I_{LX}$     | Switch Output Current  | 500  | mA   |
| $P_{TOT}$    | Power Dissipation<br>(Refer to Package thermal de-rating curve on page 19) | 450  | mW   |
| $T_{ST}$     | Storage Temperature  | -55 to 150   | °C   |
| $T_{J\ MAX}$ | Junction Temperature   | 150  | °C   |

These are stress ratings only. Operation above the absolute maximum rating may cause device failure. Operation at the absolute maximum ratings, for extended periods, may reduce device reliability.

**Thermal Resistance**

| Symbol        | Parameter           | Rating | Unit |
|---------------|---------------------|--------|------|
| $\theta_{JA}$ | Junction to Ambient | 200    | °C/W |

**Recommended Operating Conditions**

| Symbol         | Parameter                               | Min  | Typ. | Max  | Units |
|----------------|---|------|------|------|-------|
| $V_{IN}$       | Input voltage                           | 7    |      | 30   | V     |
| $t_{OFFMIN}$   | Minimum switch off-time                 |      |      | 800  | ns    |
| $t_{ONMIN}$    | Minimum switch on-time                  |      |      | 800  | ns    |
| $D_{LX}$       | Duty cycle range                        | 0.01 |      | 0.99 |       |
| $T_A$          | Ambient operating temperature range     | -40  |      | +105 | °C    |
| $I_{LX\_CONT}$ | Average/RMS LX switch current           |      |      | 0.37 | A     |
| $f_{LXmax}$    | Recommended maximum operating frequency |      |      | 1    | MHz   |
| $T_{PD}$       | Internal comparator propagation delay   |      | 50   |      | ns    |

**ZXLD1350**  
**30V 350mA LED DRIVER with AEC-Q100**

**Electrical Characteristics** (Test conditions:  $V_{IN} = 12V$ ,  $T_{amb} = 25^{\circ}C$ , unless otherwise specified.) (Note 3)

| Symbol         | Parameter   | Condition   | Min. | Typ.     | Max.  | Unit             |
|----------------|---|---|------|----------|-------|------------------|
| $V_{SU}$       | Internal regulator start-up threshold   | $V_{IN}$ rising   |      | 4.8      |       | V                |
| $I_{INQoff}$   | Quiescent supply current with output off  | ADJ pin grounded  |      | 15       | 20    | $\mu A$          |
| $I_{INQon}$    | Quiescent supply current with output switching  | ADJ pin floating<br>$f = 250kHz$  |      | 250      | 500   | $\mu A$          |
| $V_{SENSE}$    | Mean current sense threshold voltage<br>(Defines LED current setting accuracy)              | Measured on $I_{SENSE}$ pin<br>with respect to $V_{IN}$<br>$V_{ADJ} = 1.25V$                                      | 95   | 100      | 105   | mV               |
| $V_{SENSEHYS}$ | Sense threshold hysteresis  |   |      | $\pm 15$ |       | %                |
| $I_{SENSE}$    | $I_{SENSE}$ pin input current   | $V_{SENSE} = V_{IN} - 0.1$  |      | 1.25     | 10    | $\mu A$          |
| $V_{REF}$      | Internal reference voltage  | Measured on ADJ pin with<br>pin floating  | 1.21 | 1.25     | 1.29  | V                |
| $DV_{REF}/DT$  | Temperature coefficient of $V_{REF}$  |   |      | 50       |       | ppm/ $^{\circ}C$ |
| $V_{ADJ}$      | External control voltage range on ADJ pin for<br>DC brightness control (Note 4)             |   | 0.3  |          | 2.5   | V                |
| $V_{ADJoff}$   | DC voltage on ADJ pin to switch device from<br>active (on) state to quiescent (off) state   | $V_{ADJ}$ falling   | 0.15 | 0.2      | 0.25  | V                |
| $V_{ADJon}$    | DC voltage on ADJ pin to switch device from<br>quiescent (off) state to active (on) state   | $V_{ADJ}$ rising  | 0.2  | 0.25     | 0.3   | V                |
| $R_{ADJ}$      | Resistance between ADJ pin and $V_{REF}$  |   | 135  |          | 250   | k $\Omega$       |
| $I_{LXmean}$   | Continuous LX switch current  |   |      |          | 0.37  | A                |
| $R_{LX}$       | LX switch 'On' resistance   |   |      | 1.5      | 2     | $\Omega$         |
| $I_{LX(leak)}$ | LX switch leakage current   |   |      |          | 1     | $\mu A$          |
| $D_{PWM(LF)}$  | Duty cycle range of PWM signal applied to ADJ<br>pin during low frequency PWM dimming mode  | PWM frequency <500Hz<br>PWM amplitude = $V_{REF}$<br>Measured on ADJ pin  | 0.01 |          | 1     |                  |
|                | Brightness control range  |   |      |          | 100:1 |                  |
| $D_{PWM(HF)}$  | Duty cycle range of PWM signal applied to ADJ<br>pin during high frequency PWM dimming mode | PWM frequency <10kHz<br>PWM amplitude = $V_{REF}$<br>Measured on ADJ pin  | 0.16 |          | 1     |                  |
|                | Brightness control range  |   |      |          | 5:1   |                  |
| $f_{LX}$       | Operating frequency<br>(See graphs for more details)  | ADJ pin floating<br>$L = 100H (0.82V)$<br>$I_{OUT} = 350ma @ V_{LED} = 3.4V$<br>Driving 1 LED                     |      | 250      |       | kHz              |
| $t_{SS}$       | Start up time<br>(See graphs for more details)  | Time taken for output<br>current to reach 90% of final<br>value after voltage on ADJ<br>pin has risen above 0.3V. |      | 500      |       | $\mu s$          |

Notes: 3. Production testing of the device is performed at 25°C. Functional operation of the device and parameters specified over a -40°C to +105°C temperature range, are guaranteed by design, characterization and process control.

4. 100% brightness corresponds to  $V_{ADJ} = V_{ADJ(nom)} = V_{REF}$ . Driving the ADJ pin above  $V_{REF}$  will increase the  $V_{SENSE}$  threshold and output current proportionally.

---

## Device Description

---

The device, in conjunction with the coil (L1) and current sense resistor ( $R_S$ ), forms a self-oscillating continuous-mode buck converter.

### Device operation (Refer to block diagram and Figure 1 - Operating waveforms)

Operation can be best understood by assuming that the ADJ pin of the device is unconnected and the voltage on this pin ( $V_{ADJ}$ ) appears directly at the (+) input of the comparator.

When input voltage  $V_{IN}$  is first applied, the initial current in L1 and  $R_S$  is zero and there is no output from the current sense circuit. Under this condition, the (-) input to the comparator is at ground and its output is high. This turns MN on and switches the LX pin low, causing current to flow from  $V_{IN}$  to ground, via  $R_S$ , L1 and the LED(s). The current rises at a rate determined by  $V_{IN}$  and L1 to produce a voltage ramp ( $V_{SENSE}$ ) across  $R_S$ . The supply referred voltage  $V_{SENSE}$  is forced across internal resistor R1 by the current sense circuit and produces a proportional current in internal resistors R2 and R3. This produces a ground referred rising voltage at the (-) input of the comparator. When this reaches the threshold voltage ( $V_{ADJ}$ ), the comparator output switches low and MN turns off. The comparator output also drives another NMOS switch, which bypasses internal resistor R3 to provide a controlled amount of hysteresis. The hysteresis is set by R3 to be nominally 15% of  $V_{ADJ}$ .

When MN is off, the current in L1 continues to flow via D1 and the LED(s) back to  $V_{IN}$ . The current decays at a rate determined by the LED and diode forward voltages to produce a falling voltage at the input of the comparator. When this voltage returns to  $V_{ADJ}$ , the comparator output switches high again. This cycle of events repeats, with the comparator input ramping between limits of  $V_{ADJ} \pm 15\%$ .

### Switching thresholds

With  $V_{ADJ} = V_{REF}$ , the ratios of R1, R2 and R3, define an average  $V_{SENSE}$  switching threshold of 100mV (measured on the  $I_{SENSE}$  pin with respect to  $V_{IN}$ ). The average output current  $I_{OUTnom}$  is then defined by this voltage and  $R_S$  according to:

$$I_{OUTnom} = 100\text{mV}/R_S$$

Nominal ripple current is  $\pm 15\text{mV}/R_S$

### Adjusting output current

The device contains a low pass filter between the ADJ pin and the threshold comparator and an internal current limiting resistor (200k nom) between ADJ and the internal reference voltage. This allows the ADJ pin to be overdriven with either DC or pulse signals to change the  $V_{SENSE}$  switching threshold and adjust the output current. The filter is third order, comprising three sections, each with a cut-off frequency of nominally 4kHz.

Details of the different modes of adjusting output current are given in the applications section.

### Output shutdown

The output of the low pass filter drives the shutdown circuit. When the input voltage to this circuit falls below the threshold (0.2V nom), the internal regulator and the output switch are turned off. The voltage reference remains powered during shutdown to provide the bias current for the shutdown circuit. Quiescent supply current during shutdown is nominally 15mA and switch leakage is below 1mA.

**Device Description (Continued)**

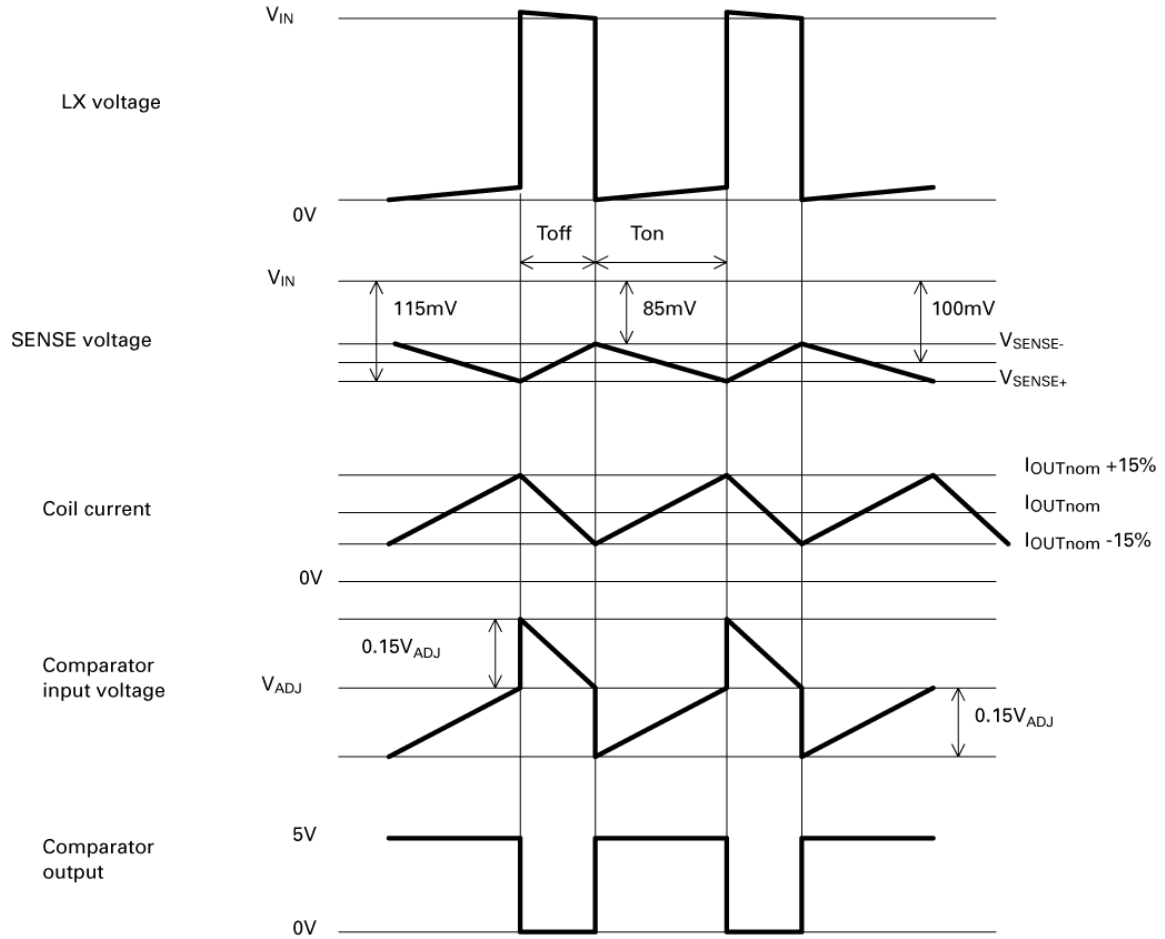

**Figure 1. Theoretical Operating Waveforms**

**Device Description (Continued)**

Typical Operating Waveforms [ $V_{IN} = 12V$ ,  $R_S = 0.3V$ ,  $L = 100 \mu H$ ]

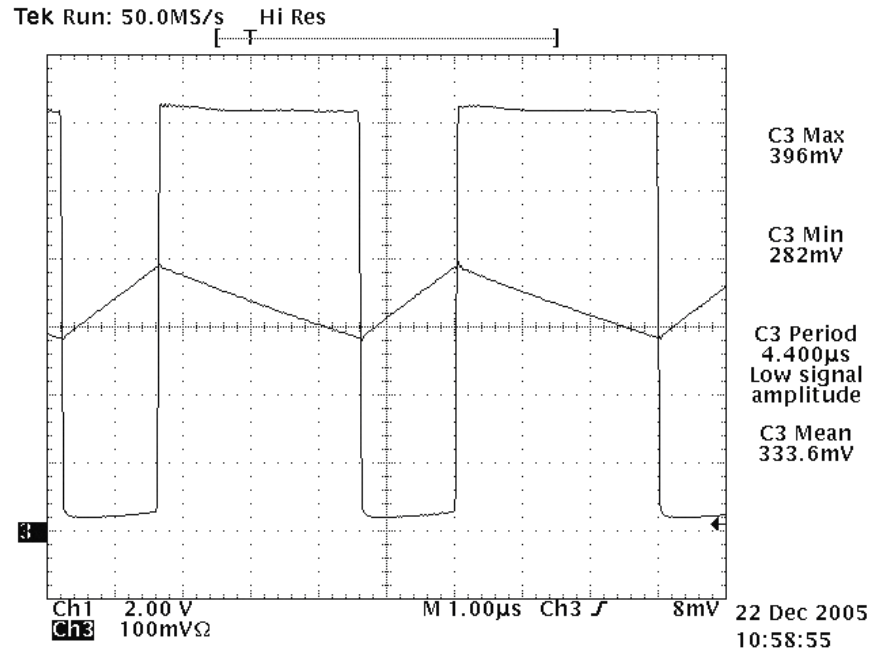

Normal operation. Output current (Ch3) and LX voltage (Ch1)

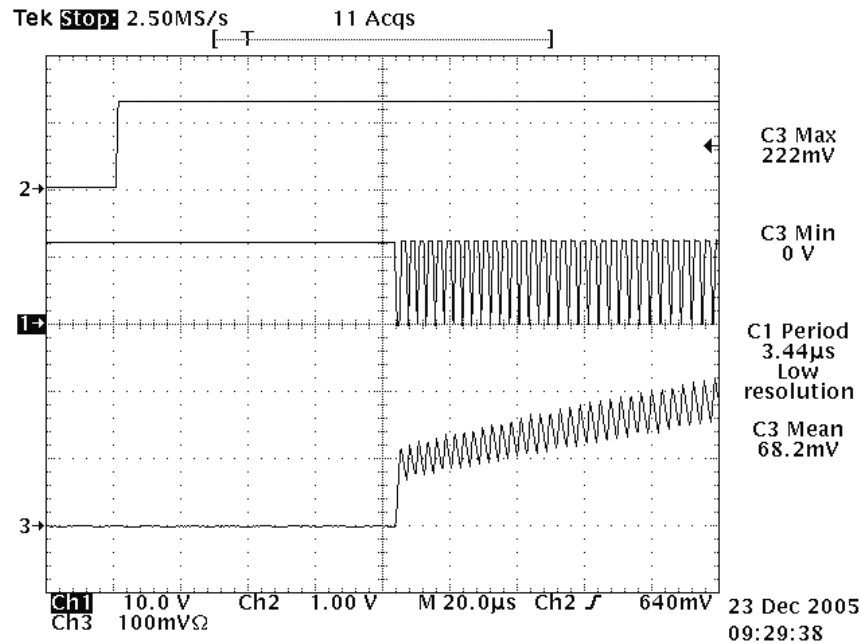

Start-up waveforms. Output current (Ch3), LX voltage (Ch1) and  $V_{ADJ}$  (Ch2)



**Typical Operating Conditions**

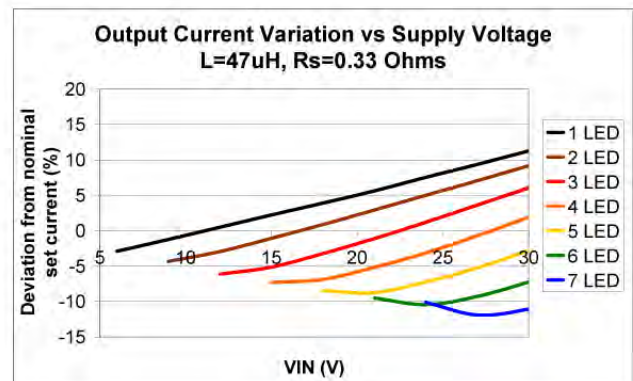
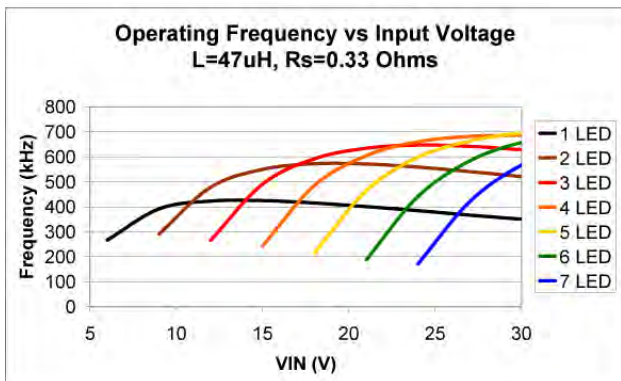
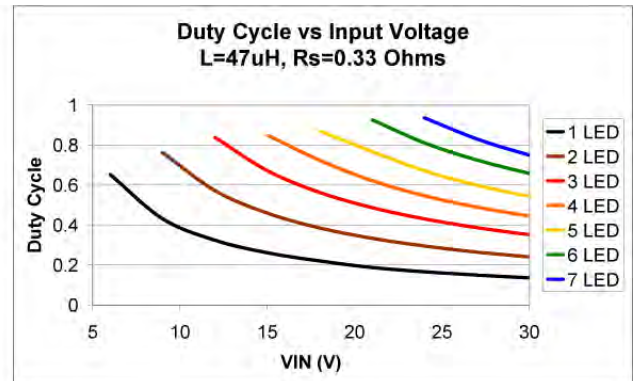
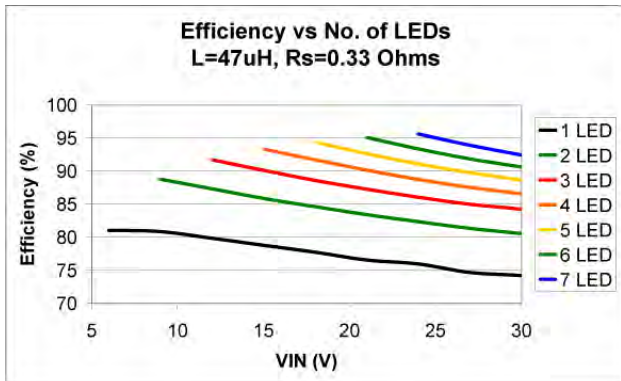
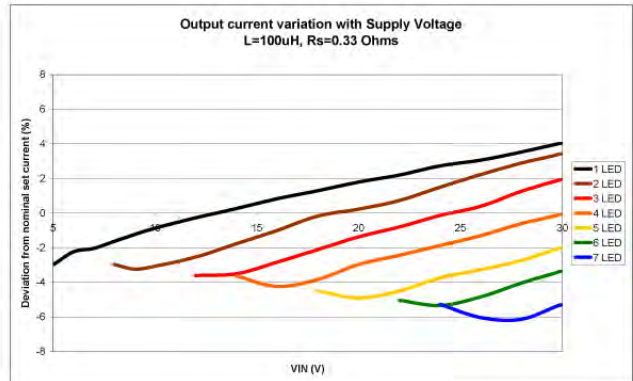
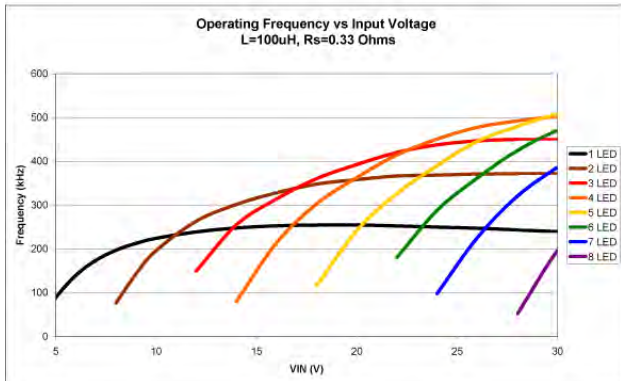
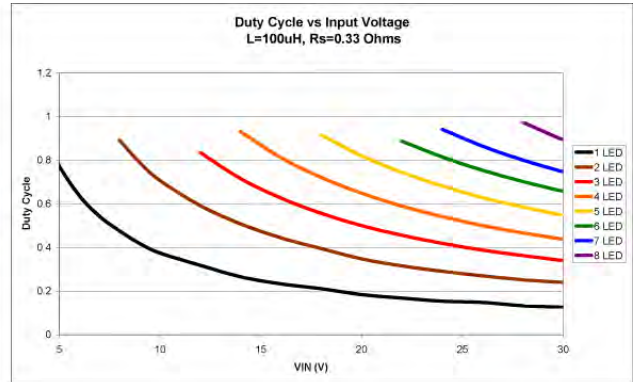
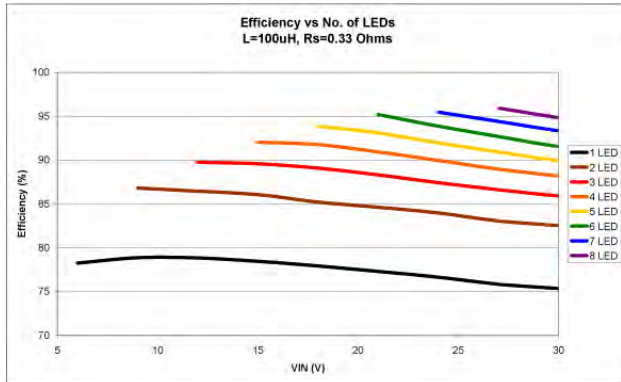



**ZXLD1350**  
**30V 350mA LED DRIVER with AEC-Q100**

**Typical Characteristics (Continued)**

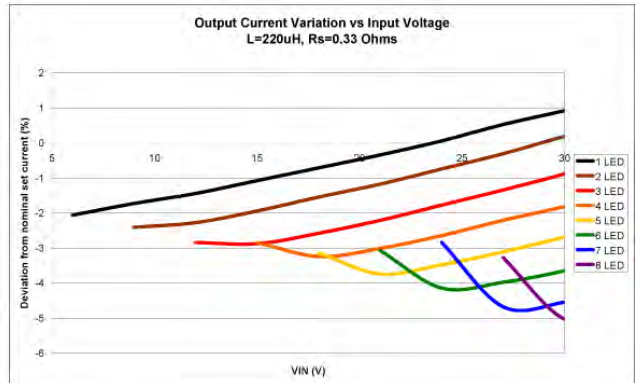
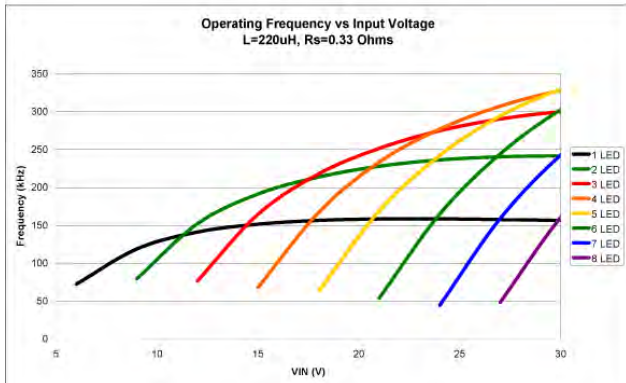
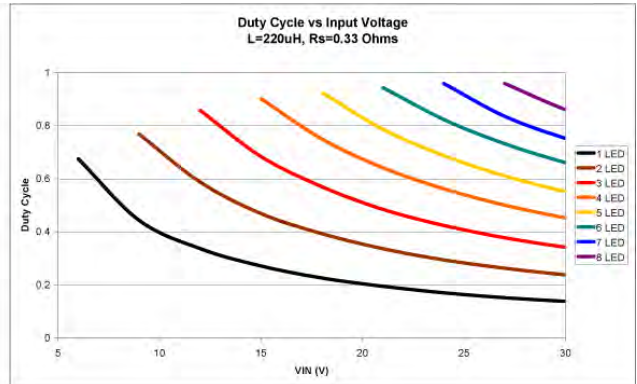
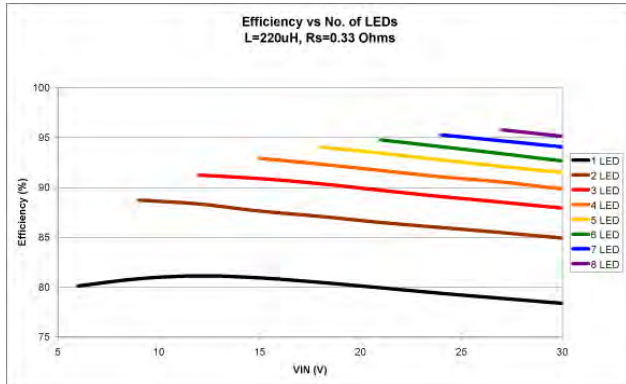

**Typical Characteristics (Continued)**

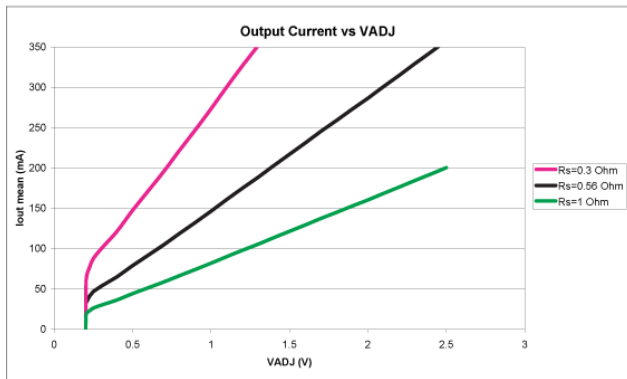
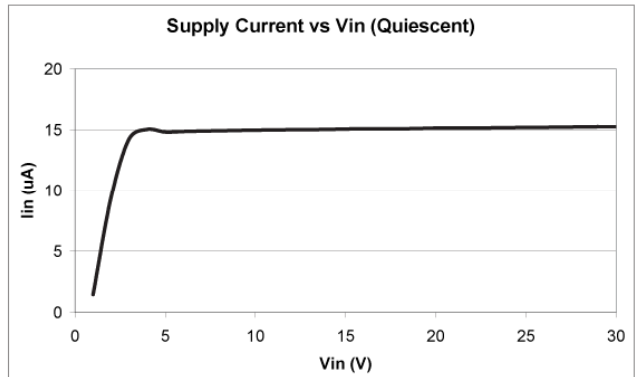
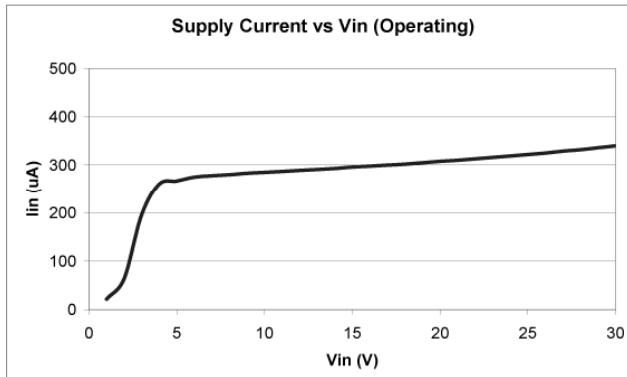
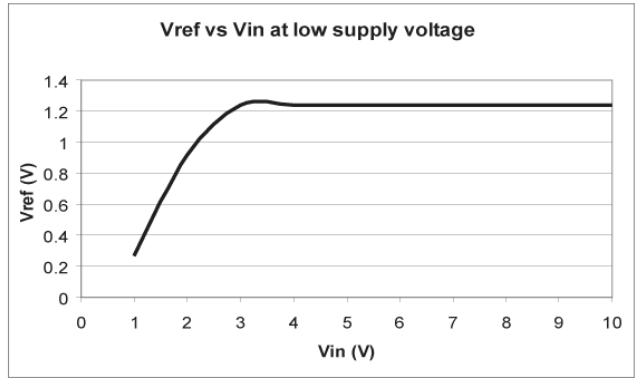
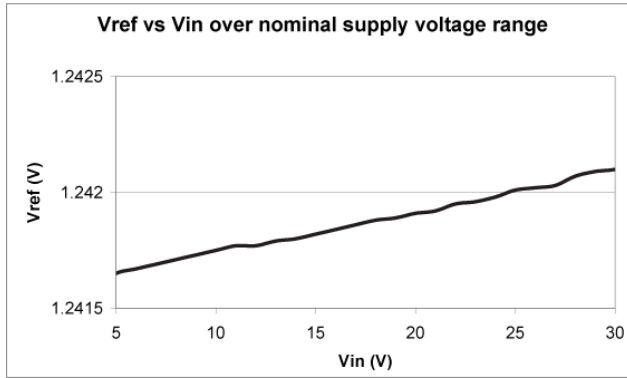

**Typical Characteristics (Continued)**

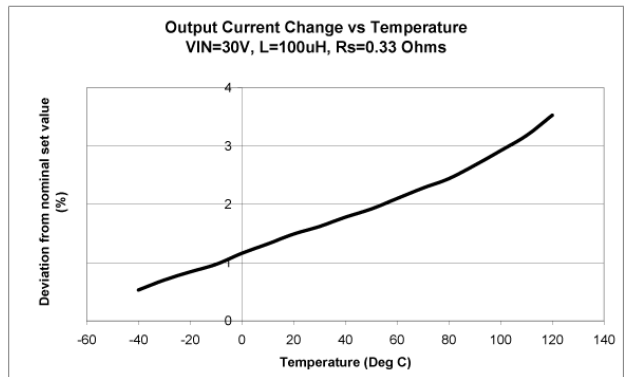
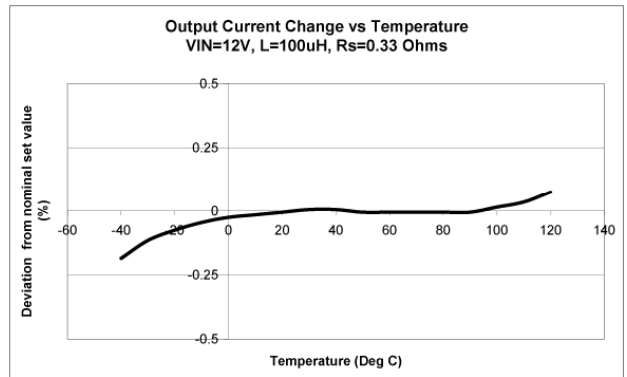
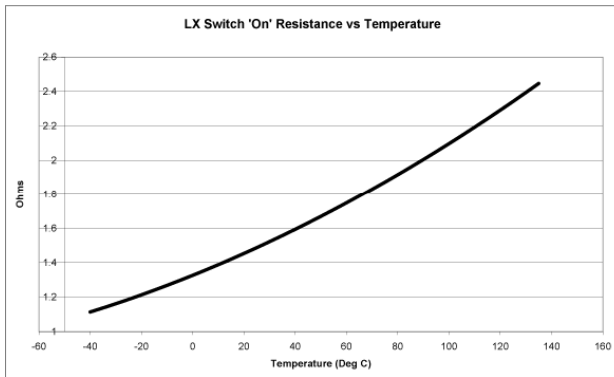
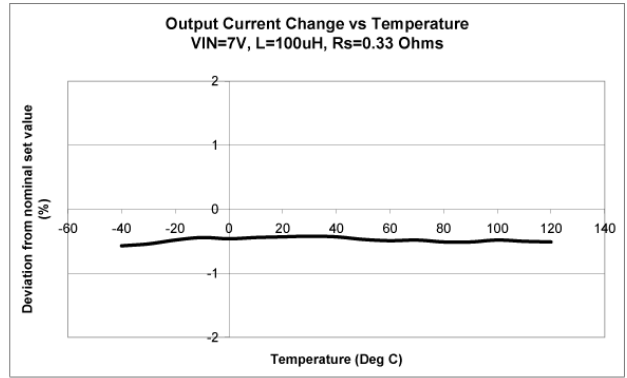
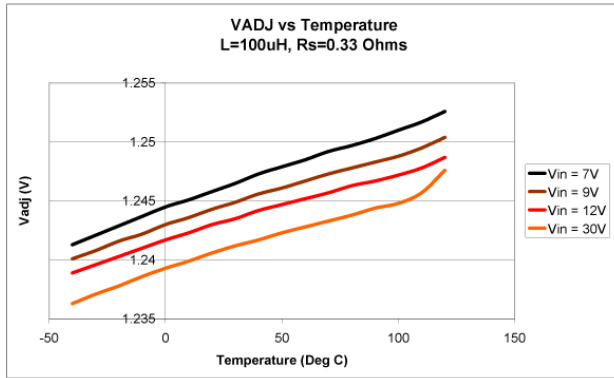

## Application Information

### Setting nominal average output current with external resistor $R_S$

The nominal average output current in the LED(s) is determined by the value of the external current sense resistor ( $R_S$ ) connected between  $V_{IN}$  and  $I_{SENSE}$  and is given by:

$$I_{OUTnom} = 0.1/R_S \text{ [for } R_S > 0.27\Omega\text{]}$$

The table below gives values of nominal average output current for several preferred values of current setting resistor ( $R_S$ ) in the typical application circuit shown on page 1:

| $R_S(\Omega)$ | Nominal average output current (mA) |
|---------------|-------------------------------------|
| 0.27          | 370                                 |
| 0.30          | 333                                 |
| 0.33          | 300                                 |
| 0.39          | 256                                 |

The above values assume that the ADJ pin is floating and at a nominal voltage of  $V_{REF}$  (=1.25V). Note that  $R_S = 0.27\Omega$  is the minimum allowed value of sense resistor under these conditions to maintain switch current below the specified maximum value.

It is possible to use different values of  $R_S$  if the ADJ pin is driven from an external voltage. (See next section).

### Output current adjustment by external DC control voltage

The ADJ pin can be driven by an external dc voltage ( $V_{ADJ}$ ), as shown, to adjust the output current to a value above or below the nominal average value defined by  $R_S$ .

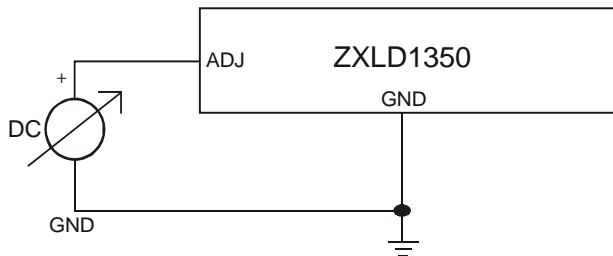

The nominal average output current in this case is given by:

$$I_{OUTdc} = 0.08 \cdot V_{ADJ} / R_S \text{ for } 0.3 < V_{ADJ} < 2.5V$$

Note that 100% brightness setting corresponds to  $V_{ADJ} = V_{REF}$ . When driving the ADJ pin above 1.25V,  $R_S$  must be increased in proportion to prevent  $I_{OUTdc}$  exceeding 370mA maximum.

The input impedance of the ADJ pin is  $200k\Omega \pm 25\%$ .

## Application Information (Continued)

### Output Current Adjustment by PWM Control

#### Directly driving ADJ input

A Pulse Width Modulated (PWM) signal with duty cycle  $D_{PWM}$  can be applied to the ADJ pin, as shown below, to adjust the output current to a value above or below the nominal average value set by resistor  $R_S$ :

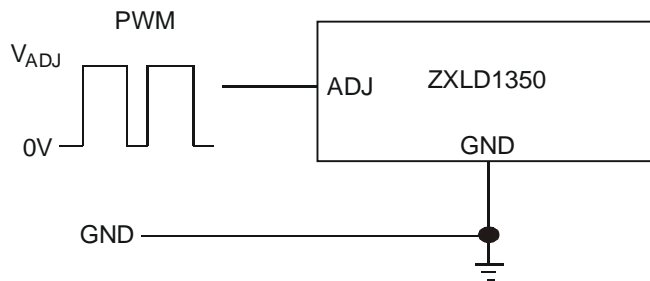

#### Driving the ADJ input via open collector transistor

The recommended method of driving the ADJ pin and controlling the amplitude of the PWM waveform is to use a small NPN switching transistor as shown below:

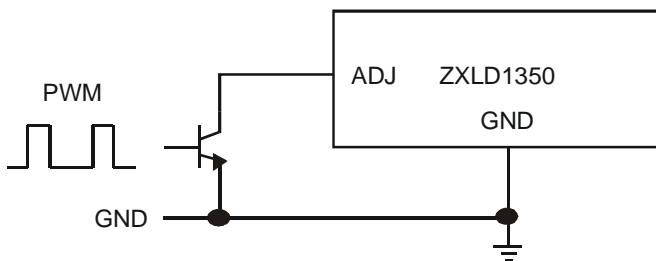

This scheme uses the 200k resistor between the ADJ pin and the internal voltage reference as a pull-up resistor for the external transistor.

#### Driving the ADJ input from a microcontroller

Another possibility is to drive the device from the open drain output of a microcontroller. The diagram below shows one method of doing this:

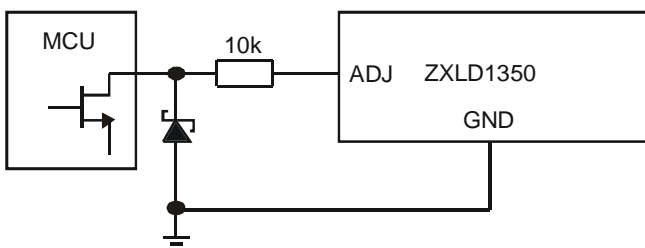

The diode and resistor suppress possible high amplitude negative spikes on the ADJ input resulting from the drain-source capacitance of the FET. Negative spikes at the input to the device should be avoided as they may cause errors in output current, or erratic device operation.

PWM dimming can be further split into high frequency and low frequency PWM dimming and how the device responds to these.

**Application Information (Continued)**

**Low frequency PWM mode**

When the ADJ pin is driven with a low frequency PWM signal (eg 100Hz), with a high level voltage  $V_{ADJ}$  and a low level of zero, the output of the internal low pass filter will swing between 0V and  $V_{ADJ}$ , causing the input to the shutdown circuit to fall below its turn-off threshold (200mV nom) when the ADJ pin is low. This will cause the output current to be switched on and off at the PWM frequency, resulting in an average output current  $I_{OUTavg}$  proportional to the PWM duty cycle. (See Figure 2 - Low frequency PWM operating waveforms).

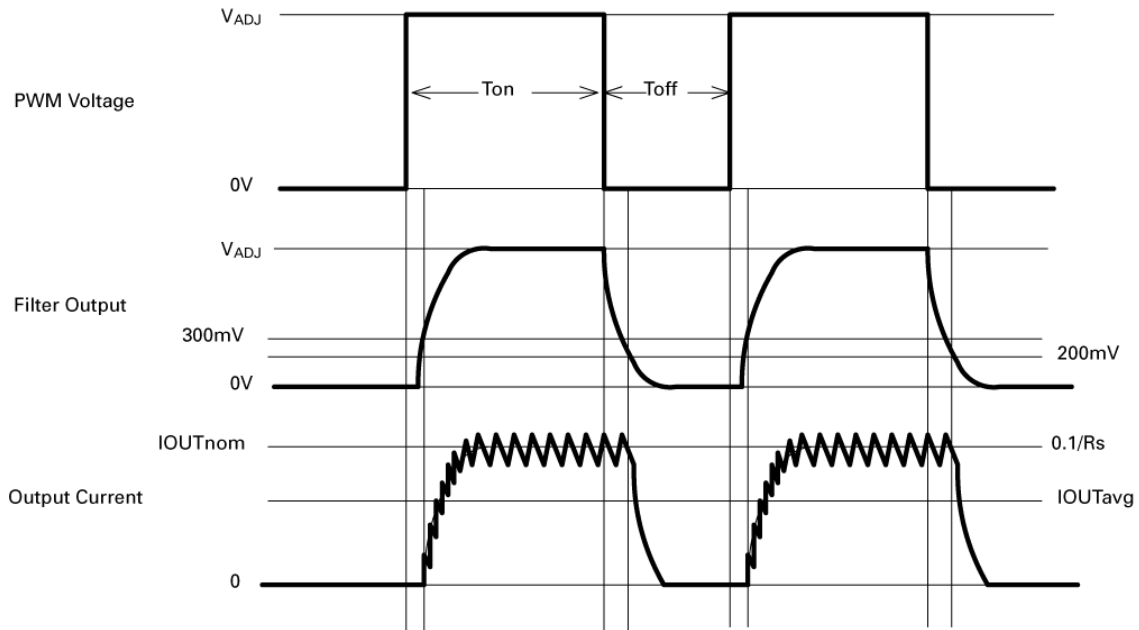

**Figure 2. Low frequency PWM operating waveforms**

The average value of output current in this mode is given by:

**$I_{OUTavg} = 0.1 D_{PWM} / R_S$  for  $D_{PWM} > 0.01$**

This mode is preferable if optimum LED 'whiteness' is required. It will also provide the widest possible dimming range (approx. 100:1) and higher efficiency at the expense of greater output ripple.

Note that the low pass filter introduces a small error in the output duty cycle due to the difference between the start-up and shut-down times. This time difference is a result of the 200mV shutdown threshold and the rise and fall times at the output of the filter. To minimize this error, the PWM duty cycle should be as low as possible consistent with avoiding flicker in the LED.

## Application Information (Continued)

### High frequency PWM mode

At PWM frequencies above 10kHz and for duty cycles above 0.16, the output of the internal low pass filter will contain a DC component that is always above the shutdown threshold. This will maintain continuous device operation and the nominal average output current will be proportional to the average voltage at the output of the filter, which is directly proportional to the duty cycle. (See Figure 3 – High frequency PWM operating waveforms). For best results, the PWM frequency should be maintained above the minimum specified value of 10kHz, in order to minimize ripple at the output of the filter. The shutdown comparator has approximately 50mV of hysteresis, to minimize erratic switching due to this ripple. An upper PWM frequency limit of approximately one tenth of the operating frequency is recommended, to avoid excessive output modulation and to avoid injecting excessive noise into the internal reference.

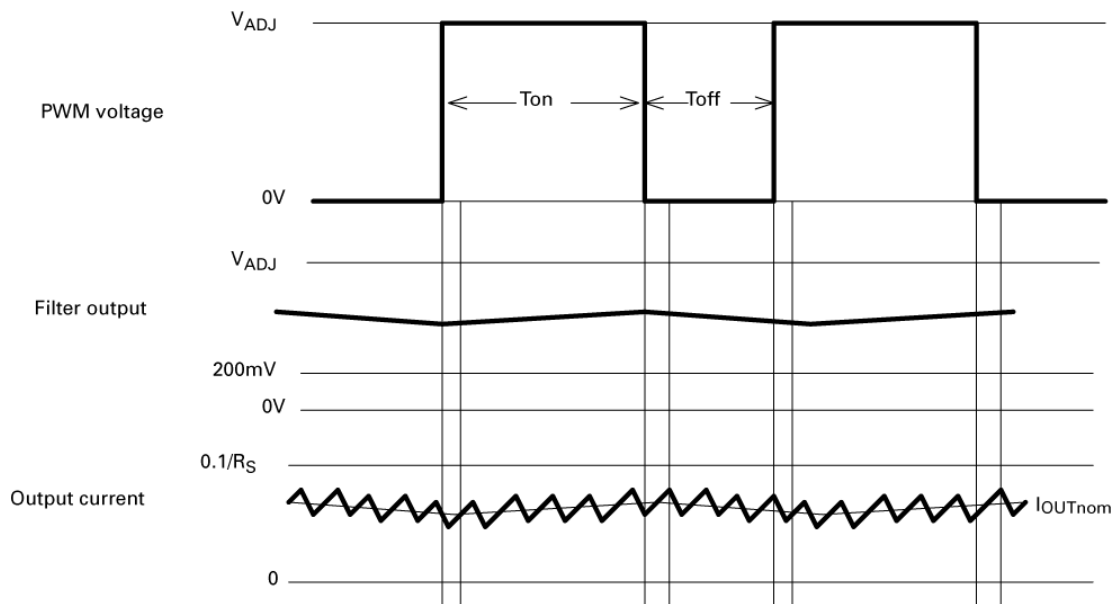

**Figure 3. High Frequency PWM operating waveforms**

The nominal average value of output current in this mode is given by:

$$I_{OUTnom} \gg 0.1 D_{PWM} / R_S \text{ for } D_{PWM} > 0.16$$

This mode will give minimum output ripple and reduced radiated emission, but with a reduced dimming range (approx.5:1). The restricted dimming range is a result of the device being turned off when the DC component on the filter output falls below 200mV.

### Shutdown mode

Taking the ADJ pin to a voltage below 0.2V for more than approximately 100µs, will turn off the output and supply current will fall to a low standby level of 15µA nominal.

Note that the ADJ pin is not a logic input. Taking the ADJ pin to a voltage above  $V_{REF}$  will increase output current above the 100% nominal average value. (See graphs for details).



## Application Information (Continued)

### Soft-start

The device has inbuilt soft-start action due to the delay through the PWM filter. An external capacitor from the ADJ pin to ground will provide additional soft-start delay, by increasing the time taken for the voltage on this pin to rise to the turn-on threshold and by slowing down the rate of rise of the control voltage at the input of the comparator. With no external capacitor, the time taken for the output to reach 90% of its final value is approximately 500 $\mu$ s. Adding capacitance increases this delay by approximately 0.5ms/nF.

The graph below shows the variation of soft-start time for different values of capacitor.

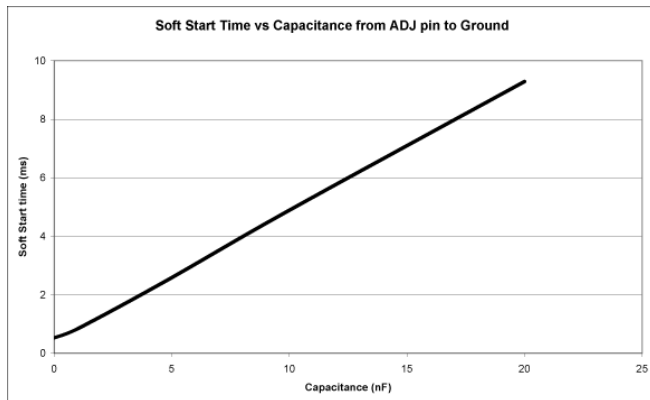

### Inherent open-circuit LED protection

If the connection to the LED(s) is open-circuited, the coil is isolated from the LX pin of the chip, so the device will not be damaged, unlike in many boost converters, where the back EMF may damage the internal switch by forcing the drain above its breakdown voltage.

### Capacitor selection

A low ESR capacitor should be used for input decoupling, as the ESR of this capacitor appears in series with the supply source impedance and lowers overall efficiency. This capacitor has to supply the relatively high peak current to the coil and smooth the current ripple on the input supply. A minimum value of 1 $\mu$ F is acceptable if the input source is close to the device, but higher values will improve performance at lower input voltages, especially when the source impedance is high. The input capacitor should be placed as close as possible to the IC.

For maximum stability over temperature and voltage, capacitors with X7R, X5R, or better dielectric are recommended. Capacitors with Y5V dielectric are not suitable for decoupling in this application and should **NOT** be used.

A table of recommended manufacturers is provided below:

| Manufacturer | Website  |
|--------------|--|
| Murata       | <a href="http://www.murata.com">www.murata.com</a>   |
| Taiyo Yuden  | <a href="http://www.t-yuden.com">www.t-yuden.com</a> |
| Kemet        | <a href="http://www.kemet.com">www.kemet.com</a>     |
| AVX          | <a href="http://www.avxcorp.com">www.avxcorp.com</a> |

## Application Information (Continued)

### Inductor Selection

Recommended inductor values for the ZXLD1350 are in the range 47 $\mu$ H to 220 $\mu$ H.

Higher values of inductance are recommended at higher supply voltages in order to minimize errors due to switching delays, which result in increased ripple and lower efficiency. Higher values of inductance also result in a smaller change in output current over the supply voltage range. (See graphs). The inductor should be mounted as close to the device as possible with low resistance connections to the LX and V<sub>IN</sub> pins.

The chosen coil should have a saturation current higher than the peak output current and a continuous current rating above the required mean output current.

Suitable coils for use with the ZXLD1350 are listed in the table below:

| Part No.   | L ( $\mu$ H) | DCR (V) | I <sub>SAT</sub> (A) | Manufacturer |
|------------|--------------|---------|----------------------|--------------|
| DO1608C    | 47           | 0.64    | 0.5                  | CoilCraft    |
| MSS6132ML  | 47           | 0.38    | 0.56                 |              |
|            | 68           | 0.58    | 0.47                 |              |
|            | 100          | 0.82    | 0.39                 |              |
| CD104-MC   | 220          | 0.55    | 0.53                 | Sumida       |
| NP04SB470M | 47           | 0.27    | 0.38                 | Taiyo Yuden  |

The inductor value should be chosen to maintain operating duty cycle and switch 'on'/'off' times within the specified limits over the supply voltage and load current range.

The following equations can be used as a guide, with reference to Figure 1 - Operating waveforms.

#### LX Switch 'On' time

$$t_{ON} = \frac{L\Delta I}{V_{IN} - V_{LED} - I_{avg} \times (R_S + r_L + R_{LX})}$$

**Note:** t<sub>ONnmin</sub> > 200ns

#### LX Switch 'Off' time

$$t_{OFF} = \frac{L\Delta I}{V_{LED} + V_D + I_{avg} \times (R_S + r_L)}$$

**Note:** t<sub>OFFmin</sub> > 200ns

#### Where:

- L is the coil inductance (H)
- r<sub>L</sub> is the coil resistance ( $\Omega$ )
- I<sub>avg</sub> is the required LED current (A)
- $\Delta I$  is the coil peak-peak ripple current (A) {Internally set to 0.3 x I<sub>avg</sub>}
- V<sub>IN</sub> is the supply voltage (V)
- V<sub>LED</sub> is the total LED forward voltage (V)
- R<sub>LX</sub> is the switch resistance ( $\Omega$ )
- V<sub>D</sub> is the rectifier diode forward voltage at the required load current (V)

**ZXLD1350**  
**30V 350mA LED DRIVER with AEC-Q100**

**Application Information (Continued)**

**Example:**

For  $V_{IN} = 12V$ ,  $L = 47\mu H$ ,  $r_L = 0.64V$ ,  $V_{LED} = 3.4V$ ,  $I_{avg} = 350mA$  and  $V_D = 0.36V$

$$t_{ON} = (47e-6 \times 0.105) / (12 - 3.4 - 0.672) = 0.622\mu s$$

$$t_{OFF} = (47e-6 \times 0.105) / (3.4 + 0.36 + 0.322) = 1.21\mu s$$

This gives an operating frequency of 546kHz and a duty cycle of 0.34.

These and other equations are available as a spreadsheet calculator from the Diodes website.

Note that in practice, the duty cycle and operating frequency will deviate from the calculated values due to dynamic switching delays, switch rise/fall times and losses in the external components.

Optimum performance will be achieved by setting the duty cycle close to 0.5 at the nominal supply voltage. This helps to equalize the undershoot and overshoot and improves temperature stability of the output current.

**Diode Selection**

For maximum efficiency and performance, the rectifier (D1) should be a fast low capacitance Schottky diode with low reverse leakage at the maximum operating voltage and temperature. The recommended diode for use with this part is the ZLLS1000. This has approximately ten times lower leakage than standard Schottky diodes, which are unsuitable for use above 85°C. It also provides better efficiency than silicon diodes, due to a combination of lower forward voltage and reduced recovery time.

The table below gives the typical characteristics for the ZLLS1000:

| Diode    | Forward Voltage @ 100mA (mV) | Continuous Current (mA) | Reverse Leakage @ 30V 85°C (mA) | Package |
|----------|------------------------------|-------------------------|---------------------------------|---------|
| ZLLS1000 | 310                          | 1000                    | 300                             | TSOT23  |

If alternative diodes are used, it is important to select parts with a peak current rating above the peak coil current and a continuous current rating higher than the maximum output load current. It is very important to consider the reverse leakage of the diode when operating above 85°C. Excess leakage will increase the power dissipation in the device.

The higher forward voltage and overshoot due to reverse recovery time in silicon diodes will increase the peak voltage on the LX output. If a silicon diode is used, care should be taken to ensure that the total voltage appearing on the LX pin including supply ripple, does not exceed the specified maximum value.

**Reducing Output Ripple**

Peak to peak ripple current in the LED(s) can be reduced, if required, by shunting a capacitor  $C_{led}$  across the LED(s) as shown below:

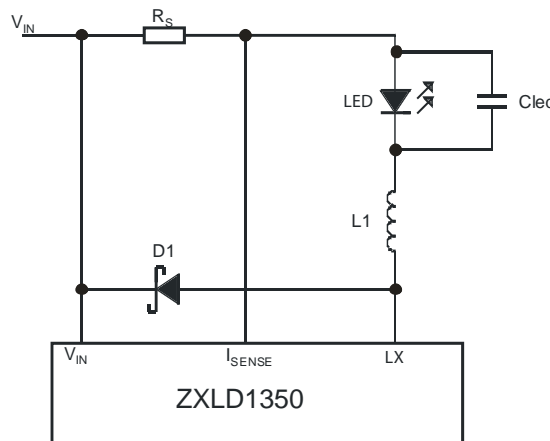

## Application Information (Continued)

A value of 1  $\mu\text{F}$  will reduce nominal ripple current by a factor three (approx.). Proportionally lower ripple can be achieved with higher capacitor values. Note that the capacitor will not affect operating frequency or efficiency, but it will increase start-up delay, by reducing the rate of rise of LED voltage.

### Operation at low supply voltage

The internal regulator disables the drive to the switch until the supply has risen above the start-up threshold (VSU). Above this threshold, the device will start to operate. However, with the supply voltage below the specified minimum value, the switch duty cycle will be high and the device power dissipation will be at a maximum. Care should be taken to avoid operating the device under such conditions in the application, in order to minimize the risk of exceeding the maximum allowed die temperature. (See next section on thermal considerations).

Note that when driving loads of two or more LEDs, the forward drop will normally be sufficient to prevent the device from switching below approximately 6V. This will minimize the risk of damage to the device.

### Thermal considerations

When operating the device at high ambient temperatures, or when driving maximum load current, care must be taken to avoid exceeding the package power dissipation limits. The graph below gives details for power derating. This assumes the device to be mounted on a (25mm)<sup>2</sup> PCB with 1oz copper standing in still air.

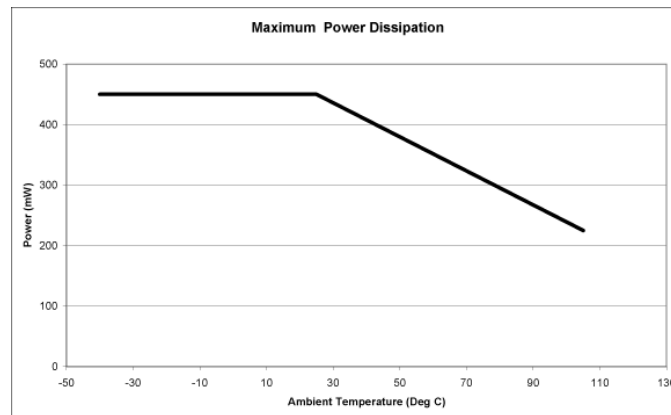

Note that the device power dissipation will most often be a maximum at minimum supply voltage. It will also increase if the efficiency of the circuit is low. This may result from the use of unsuitable coils, or excessive parasitic output capacitance on the switch output.

### Thermal compensation of output current

High luminance LEDs often need to be supplied with a temperature compensated current in order to maintain stable and reliable operation at all drive levels. The LEDs are usually mounted remotely from the device, so for this reason, the temperature coefficients of the internal circuits for the ZXLD1350 have been optimized to minimize the change in output current when no compensation is employed. If output current compensation is required, it is possible to use an external temperature sensing network - normally using Negative Temperature Coefficient (NTC) thermistors and/or diodes, mounted very close to the LED(s). The output of the sensing network can be used to drive the ADJ pin in order to reduce output current with increasing temperature.

---

**Application Information (Continued)**

---

**Layout considerations****LX pin**

The LX pin of the device is a fast switching node, so PCB tracks should be kept as short as possible. To minimize ground 'bounce', the ground pin of the device should be soldered directly to the ground plane.

**Coil and decoupling capacitors**

It is particularly important to mount the coil and the input decoupling capacitor close to the device to minimize parasitic resistance and inductance, which will degrade efficiency. It is also important to take account of any track resistance in series with current sense resistor RS.

**ADJ pin**

The ADJ pin is a high impedance input, so when left floating, PCB tracks to this pin should be as short as possible to reduce noise pickup. A 100nF capacitor from the ADJ pin to ground will reduce frequency modulation of the output under these conditions. An additional series 10kΩ resistor can also be used when driving the ADJ pin from an external circuit (see below). This resistor will provide filtering for low frequency noise and provide protection against high voltage transients.

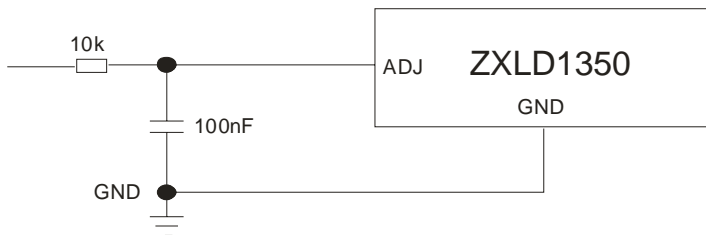
**High voltage tracks**

Avoid running any high voltage tracks close to the ADJ pin, to reduce the risk of leakage due to board contamination. Any such leakage may raise the ADJ pin voltage and cause excessive output current. A ground ring placed around the ADJ pin will minimize changes in output current under these conditions.

**ZXLD1350**  
**30V 350mA LED DRIVER with AEC-Q100**

**Ordering Information**

| Device        | Part Mark | Package Code | Packaging (Note 5) | Reel size (mm) | Reel width (mm) | Quantity per reel | Part Number Suffix | AEC-Q100 Level |
|---------------|-----------|--------------|--------------------|----------------|-----------------|-------------------|--------------------|----------------|
| ZXLD1350ET5TA | 1350      | ET5          | TSOT23-5           | 180            | 8               | 3000              | TA                 | Grade 2        |

Note: 5. Pad layout as shown on Diodes Inc. suggested pad layout document AP02001, which can be found on our website at <http://www.diodes.com/datasheets/ap02001.pdf>.

**Package Outline Dimensions**

**TSOT23-5**

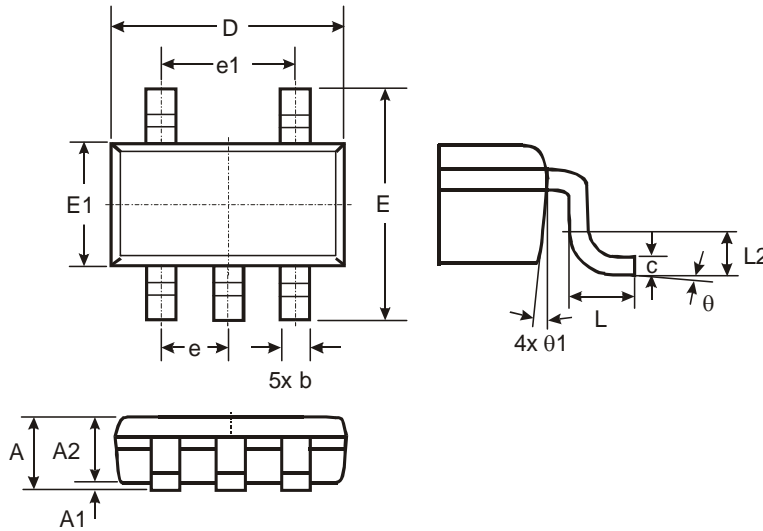

| TSOT23-5                    |      |      |      |
|-----------------------------|------|------|------|
| Dim                         | Min  | Max  | Typ  |
| A                           | -    | 1.00 | -    |
| A1                          | 0.01 | 0.10 | -    |
| A2                          | 0.84 | 0.90 | -    |
| D                           | -    | -    | 2.90 |
| E                           | -    | -    | 2.80 |
| E1                          | -    | -    | 1.60 |
| b                           | 0.30 | 0.45 | -    |
| c                           | 0.12 | 0.20 | -    |
| e                           | -    | -    | 0.95 |
| e1                          | -    | -    | 1.90 |
| L                           | 0.30 | 0.50 | -    |
| L2                          | -    | -    | 0.25 |
| theta                       | 0°   | 8°   | 4°   |
| theta1                      | 4°   | 12°  | -    |
| <b>All Dimensions in mm</b> |      |      |      |

**ZXLD1350**  
**30V 350mA LED DRIVER with AEC-Q100**

**IMPORTANT NOTICE**

DIODES INCORPORATED MAKES NO WARRANTY OF ANY KIND, EXPRESS OR IMPLIED, WITH REGARDS TO THIS DOCUMENT, INCLUDING, BUT NOT LIMITED TO, THE IMPLIED WARRANTIES OF MERCHANTABILITY AND FITNESS FOR A PARTICULAR PURPOSE (AND THEIR EQUIVALENTS UNDER THE LAWS OF ANY JURISDICTION).

Diodes Incorporated and its subsidiaries reserve the right to make modifications, enhancements, improvements, corrections or other changes without further notice to this document and any product described herein. Diodes Incorporated does not assume any liability arising out of the application or use of this document or any product described herein; neither does Diodes Incorporated convey any license under its patent or trademark rights, nor the rights of others. Any Customer or user of this document or products described herein in such applications shall assume all risks of such use and will agree to hold Diodes Incorporated and all the companies whose products are represented on Diodes Incorporated website, harmless against all damages.

Diodes Incorporated does not warrant or accept any liability whatsoever in respect of any products purchased through unauthorized sales channel.

Should Customers purchase or use Diodes Incorporated products for any unintended or unauthorized application, Customers shall indemnify and hold Diodes Incorporated and its representatives harmless against all claims, damages, expenses, and attorney fees arising out of, directly or indirectly, any claim of personal injury or death associated with such unintended or unauthorized application.

Products described herein may be covered by one or more United States, international or foreign patents pending. Product names and markings noted herein may also be covered by one or more United States, international or foreign trademarks.

**LIFE SUPPORT**

Diodes Incorporated products are specifically not authorized for use as critical components in life support devices or systems without the express written approval of the Chief Executive Officer of Diodes Incorporated. As used herein:

A. Life support devices or systems are devices or systems which:

1. are intended to implant into the body, or
2. support or sustain life and whose failure to perform when properly used in accordance with instructions for use provided in the labeling can be reasonably expected to result in significant injury to the user.

B. A critical component is any component in a life support device or system whose failure to perform can be reasonably expected to cause the failure of the life support device or to affect its safety or effectiveness.

Customers represent that they have all necessary expertise in the safety and regulatory ramifications of their life support devices or systems, and acknowledge and agree that they are solely responsible for all legal, regulatory and safety-related requirements concerning their products and any use of Diodes Incorporated products in such safety-critical, life support devices or systems, notwithstanding any devices- or systems-related information or support that may be provided by Diodes Incorporated. Further, Customers must fully indemnify Diodes Incorporated and its representatives against any damages arising out of the use of Diodes Incorporated products in such safety-critical, life support devices or systems.

Copyright © 2011, Diodes Incorporated

[www.diodes.com](http://www.diodes.com)