

# IS32LT3954A

## CONSTANT-CURRENT 3-AMPERE PWM DIMMABLE BUCK REGULATOR LED DRIVER WITH OUTPUT FAULT REPORTING

April 2020

### GENERAL DESCRIPTION

The IS32LT3954A is a DC-to-DC switching converter that integrates an N-channel MOSFET to operate in a buck configuration. The device can operate from a wide input voltage between 4.5V and 38V and provides a constant current of up to 3A for driving a single LED or multiple series connected LEDs.

The external resistor,  $R_{SET}$ , is used to set a constant LED output current, while allowing the output voltage to be automatically adjusted for a variety of LED configurations.

The IS32LT3954A operates in a fixed frequency mode during switching. There is an external resistor connected between the VCC and TON pins used to configure the on-time (switching frequency). The switching frequency is dithered for spread spectrum operation which will spread the electromagnetic energy into a wider frequency band. This function is helpful for optimizing EMI performance.

A logic input PWM signal applied to the enable (EN) pin will adjust the average LED current. The LED brightness is proportional to the duty cycle of the PWM signal.

True average output current operation is achieved with fast transient response by using cycle-by-cycle, controlled on-time method.

In addition, IS32LT3954A integrates various fault protections for robust operation. Detection of these faults is reported by the FAULTB I/O pin. Multiple devices can have their FAULTB pins connected to create a “One-Fail-All-Fail” system operation.

The IS32LT3954A is available in an SOP-8-EP package with an exposed pad for enhanced thermal dissipation. It operates from 4.5V to 38V over the temperature range of -40°C to +125°C.

### FEATURES

- Wide input voltage supply from 4.5V to 38V
  - Withstand 40V load dump
- True average output current control
- 3A maximum output over operating temperature range
- Cycle-by-cycle current limit
- Integrated high-side MOSFET switch
- Dimming via direct logic input or power supply voltage
- Internal control loop compensation
- Under-voltage lockout (UVLO) and thermal shutdown protection
- 2 $\mu$ A low power shutdown
- Spread spectrum to optimize EMI
- Robust fault protection and reporting function:
  - Pin-to-GND short
  - Component open/short faults
  - Adjacent pin-to-pin short
  - LED open/short
  - Thermal shutdown
- Shared fault flag for multiple device operation to meet “One-Fail-All-Fail”
- AEC-Q100 Qualified

### APPLICATIONS

- Automotive and avionic lighting
- Daytime running lights
- Turn/stop lights
- Front and rear fog lights
- Matrix headlight
- Motorcycle headlight

# IS32LT3954A

## TYPICAL APPLICATION CIRCUIT

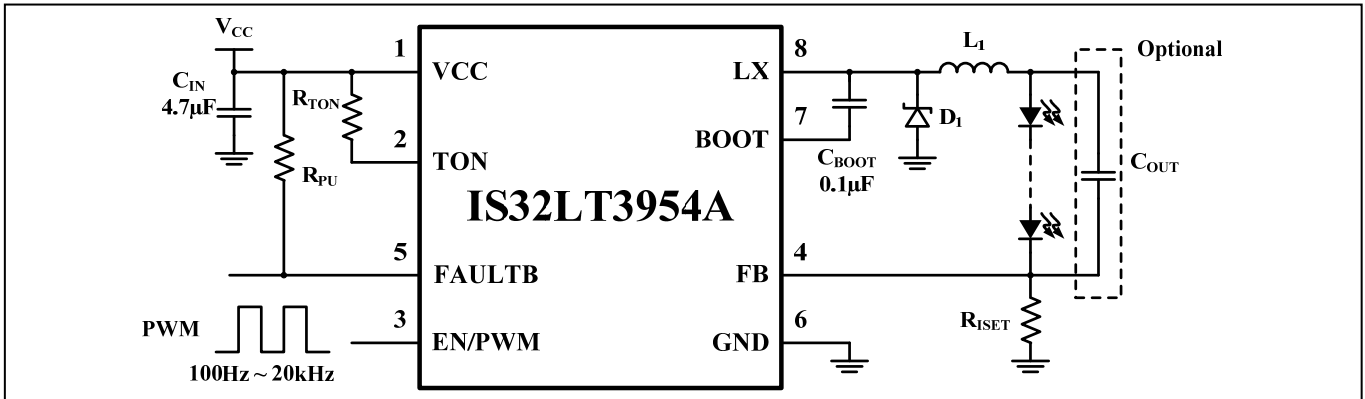


Figure 1 Typical Application Circuit

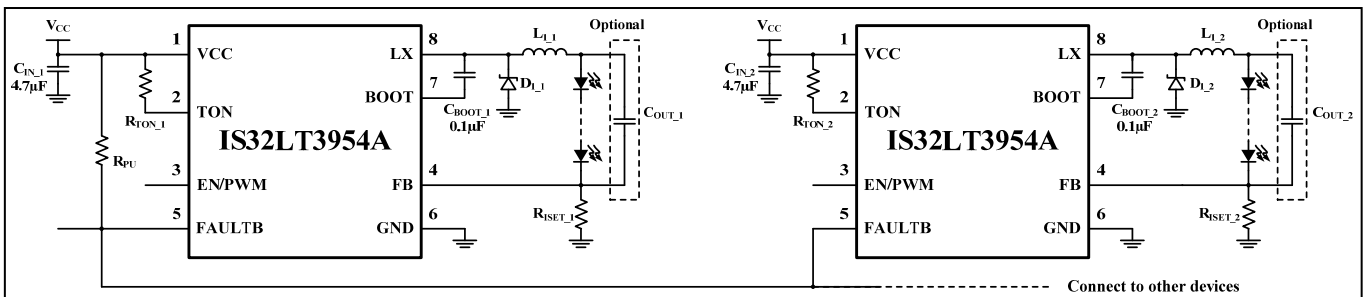
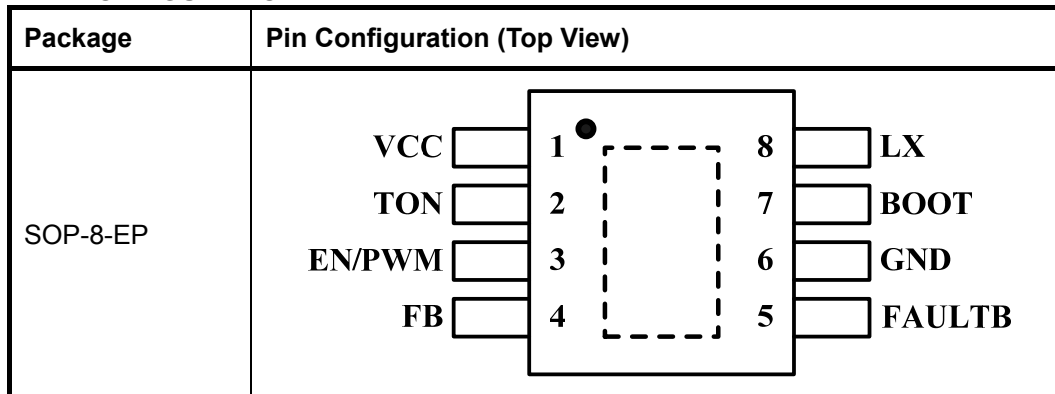


Figure 2 Typical Application Circuit (Several Devices In Parallel with FAULTB Interconnection)

# IS32LT3954A

## PIN CONFIGURATION



## PIN DESCRIPTION

No.	Pin	Description
1	VCC	Power supply input. Connect a bypass capacitor $C_{IN}$ to ground. The path from $C_{IN}$ to GND and VCC pins should be as short as possible.
2	TON	On-time setting. Connect a resistor from this pin to VCC pin to set the regulator controlled on-time.
3	EN/PWM	Logic input for enable and PWM dimming. Pull up above 1.4V to enable and below 0.4V to disable. Input a 100Hz~20kHz PWM signal to dim the LED brightness.
4	FB	Drive output current sense feedback. Set the output current by connecting a resistor from this pin to the ground.
5	FAULTB	Open drain I/O diagnostic pin. Active low output driven by the device when it detects a fault condition. As an input, this pin will accept an externally generated FAULTB signal to disable the device output to satisfy the “One-Fail-All-Fail” function. Note this pin requires an external pull up resistor ( $R_{PU}$ ).
6	GND	Ground.
7	BOOT	Internal MOSFET gate driver bootstrap. Connect a 0.1 $\mu$ F X7R ceramic capacitor from this pin to LX pin.
8	LX	Internal high-side MOSFET switch output. Connect this pin to the inductor and Schottky diode.
	Thermal Pad	Connect to GND.

# IS32LT3954A

## ORDERING INFORMATION

Automotive Range: -40°C to +125°C

Order Part No.	Package	QTY/Reel
IS32LT3954A-GRLA3-TR	SOP-8-EP, Lead-free	2500

Copyright © 2020 Lumissil Microsystems. All rights reserved. Lumissil Microsystems reserves the right to make changes to this specification and its products at any time without notice. Lumissil Microsystems assumes no liability arising out of the application or use of any information, products or services described herein. Customers are advised to obtain the latest version of this device specification before relying on any published information and before placing orders for products.

Lumissil Microsystems does not recommend the use of any of its products in life support applications where the failure or malfunction of the product can reasonably be expected to cause failure of the life support system or to significantly affect its safety or effectiveness. Products are not authorized for use in such applications unless Lumissil Microsystems receives written assurance to its satisfaction, that:

- a.) the risk of injury or damage has been minimized;
- b.) the user assume all such risks; and
- c.) potential liability of Lumissil Microsystems is adequately protected under the circumstances

# IS32LT3954A

## ABSOLUTE MAXIMUM RATINGS (Note 1)

Input voltage, $V_{CC}$ (Note 2)	-0.3V ~ +42V
Bootstrap to switching voltage, ( $V_{BOOT}-V_{LX}$ )	-0.3V ~ +6.0V
Switching voltage, $V_{LX}$ (Steady state)	-0.6V ~ $V_{CC} + 0.3V$
Switching voltage, $V_{LX}$ (Transient < 10ns)	-3.0V
EN/PWM, TON and FAULTB voltage, $V_{EN/PWM}$ , $V_{TON}$ and $V_{FAULTB}$	-0.3V ~ $V_{CC} + 0.3$
Current sense voltage, $V_{FB}$	-0.3V ~ 6.0V
Power dissipation, $P_{D(MAX)}$	2.34W
Operating temperature, $T_A=T_J$	-40°C ~ +150°C
Storage temperature, $T_{STG}$	-65°C ~ +150°C
Junction temperature, $T_{JMAX}$	+150°C
Package thermal resistance, junction to ambient (4 layer standard test PCB based on JESD 51-2A), $\theta_{JA}$	42.7 °C/W
Package thermal resistance, junction to thermal PAD (4 layer standard test PCB based on JESD 51-8), $\theta_{JP}$	1.41 °C/W
ESD (HBM)	±2kV
ESD (CDM)	±750V

**Note 1:** Stresses beyond those listed under “Absolute Maximum Ratings” may cause permanent damage to the device. These are stress ratings only and functional operation of the device at these or any other condition beyond those indicated in the operational sections of the specifications is not implied. Exposure to absolute maximum rating conditions for extended periods may affect device reliability.

**Note 2:** A maximum of 44V can be sustained at this pin for a duration of  $\leq 2s$ .

## ELECTRICAL CHARACTERISTICS

$V_{CC}=24V$ ,  $T_J=T_A=-40^\circ C \sim +125^\circ C$ , Typical values are at  $T_J=25^\circ C$ , unless otherwise noted.

Symbol	Parameter	Conditions	Min.	Typ.	Max.	Unit
$V_{CC}$	Input supply voltage		4.5		38	V
$V_{UVLO}$	VCC undervoltage lockout threshold	$V_{CC}$ increasing	4.05	4.25	4.45	V
$V_{UVLO\_HY}$	VCC undervoltage lockout hysteresis	$V_{CC}$ decreasing		250		mV
$I_{CC}$	VCC pin supply current	$V_{FB} = 0.5V$ , $V_{EN/PWM} = \text{high}$		1.2	2	mA
$I_{SD}$	VCC pin shutdown current	EN/PWM shorted to GND		2	10	$\mu A$
$I_{SWLIM}$	Buck switch current limit threshold		3.5	4.5	5.5	A
$t_{OCP}$	Over Current Protection (OCP) hiccup time	(Note 3)		1		ms
$R_{DS\_ON}$	Buck switch on-resistance	$V_{BOOT} = V_{CC} + 4.3V$ , $I_{LX} = 1A$		0.2	0.4	$\Omega$
$V_{BTUV}$	BOOT undervoltage lockout threshold	$V_{BOOT}$ to $V_{LX}$ increasing		3.3		V
$V_{BTUV\_HY}$	BOOT undervoltage lockout hysteresis	$V_{BOOT}$ to $V_{LX}$ decreasing		400		mV
$t_{OFF\_MIN}$	Switching minimum off-time	$V_{FB} = 0V$		110	150	ns
$t_{ON\_MIN}$	Switching minimum on-time			120	150	ns
$t_{ON}$	Selected on-time	$V_{CC} = 24V$ , $V_{OUT} = 12V$ , $R_{TON} = 420k\Omega$	800	1000	1200	ns
<b>Regulation Comparator and Error Amplifier</b>						
$V_{FB}$	Load current sense regulation threshold	$V_{FB}$ decreasing, LX turns on, $T_J = 25^\circ C$	195	200	205	mV
		$V_{FB}$ decreasing, LX turns on, $T_J = -40^\circ C \sim 125^\circ C$	190	200	210	

# IS32LT3954A

## ELECTRICAL CHARACTERISTICS (CONTINUE)

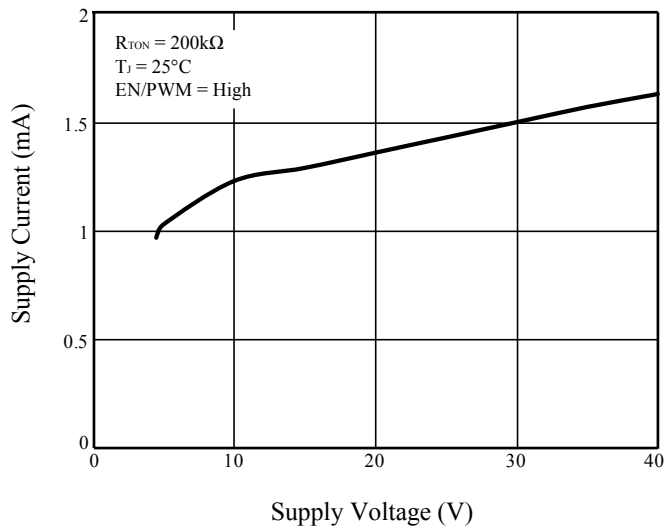
$V_{CC} = 24V$ ,  $T_J = T_A = -40^{\circ}C \sim +125^{\circ}C$ , Typical values are at  $T_J = 25^{\circ}C$ , unless otherwise noted.

Symbol	Parameter	Conditions	Min.	Typ.	Max.	Unit
<b>FAULTB OPEN DRAIN OUTPUT</b>						
$V_{FAULTB}$	FAULTB pin pull down voltage	Fault condition, sink current $I_{OL} = 5mA$		0.1	0.2	V
$I_{LK\_FAULTB}$	FAULTB pin leakage current	No fault condition, pull up to 12V			1	$\mu A$
$t_{DELAY1}$	Fault detect to fault report delay time			10		ms
$t_{DELAY2}$	Fault recover to fault report delay time			10		ms
$V_{FAULTB\_IH}$	FAULTB pin input high enable threshold		1.4			V
$V_{FAULTB\_IL}$	FAULTB pin input low disable threshold				0.4	V
<b>Enable Input</b>						
$V_{IH}$	Logic high voltage	$V_{EN/PWM}$ increasing	1.4			V
$V_{IL}$	Logic low voltage	$V_{EN/PWM}$ decreasing			0.4	V
$R_{PWMPD}$	EN/PWM pin pull-down resistance	$V_{EN/PWM} = 5V$	100	200	300	$k\Omega$
$t_{PWML}$	Duration EN/PWM pin kept low to shutdown the device		55	65	80	ms
$t_{PVMH}$	Duration EN/PWM pin kept high to quit from shutdown mode	(Note 3)		16	25	$\mu s$
$t_{PWMSW}$	The latency of EN/PWM pull high to IC starts switching	(Note 3)		120	150	$\mu s$
<b>Thermal Shutdown</b>						
$T_{SD}$	Thermal shutdown threshold	(Note 3)		165		$^{\circ}C$
$T_{SDHYS}$	Thermal shutdown hysteresis	(Note 3)		25		$^{\circ}C$

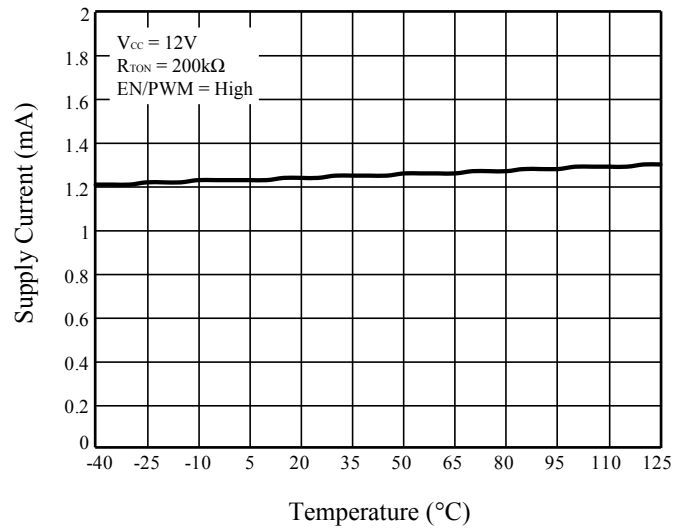
**Note 3:** Guaranteed by design.

# IS32LT3954A

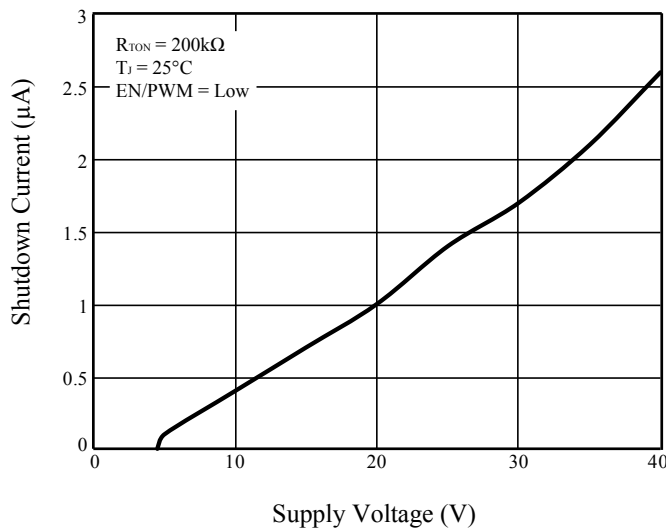
## TYPICAL PERFORMANCE CHARACTERISTICS



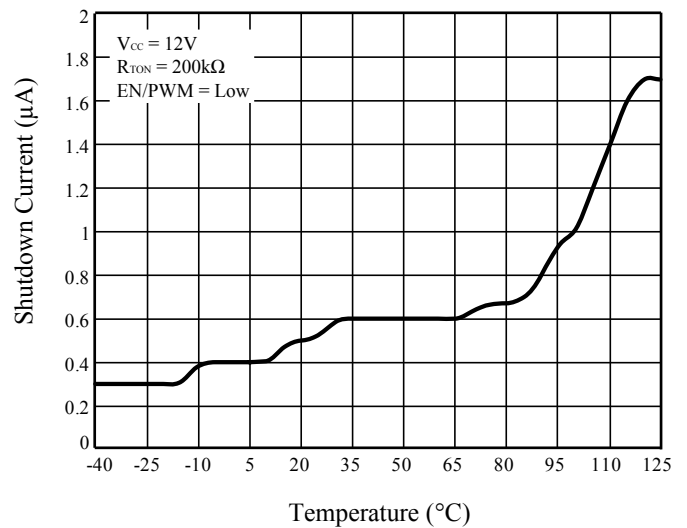
**Figure 3**  $I_{CC}$  vs.  $V_{CC}$



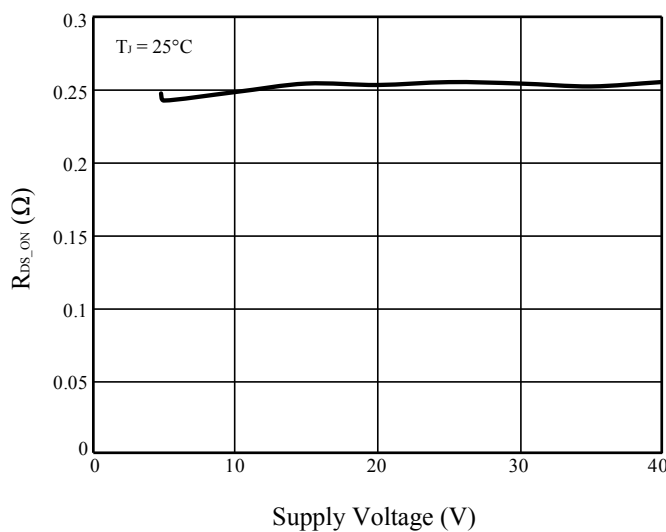
**Figure 4**  $I_{CC}$  vs. Temperature



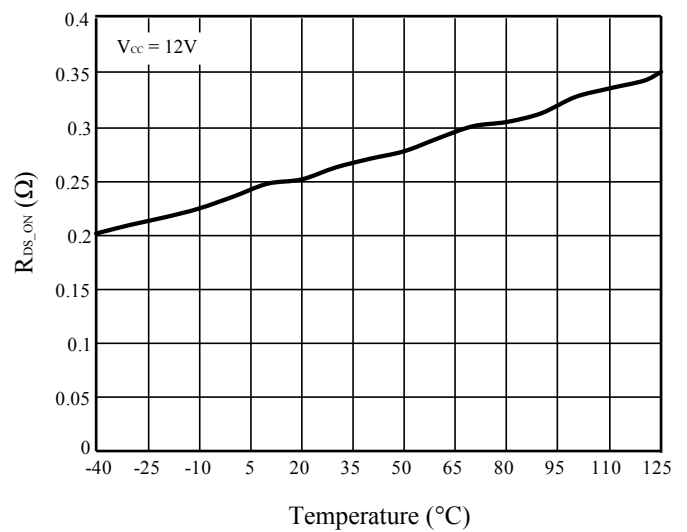
**Figure 5**  $I_{SD}$  vs.  $V_{CC}$



**Figure 6**  $I_{SD}$  vs. Temperature

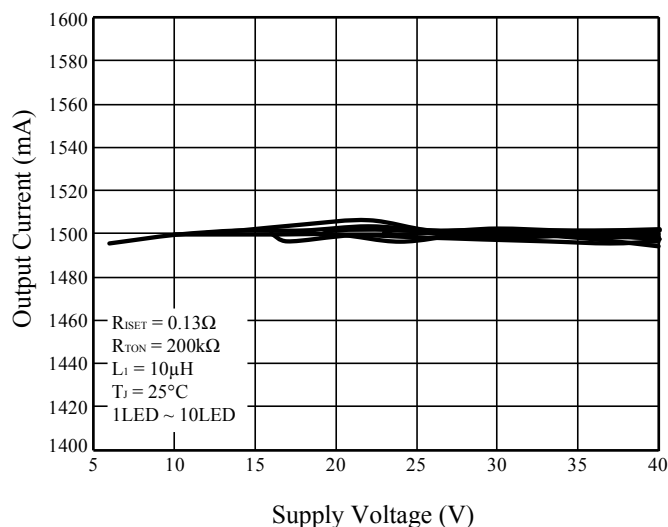


**Figure 7**  $R_{DS\_ON}$  vs.  $V_{CC}$

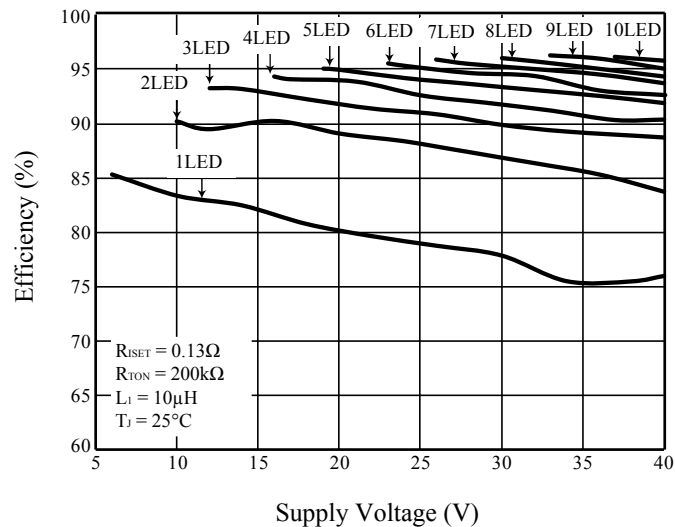


**Figure 8**  $R_{DS\_ON}$  vs. Temperature

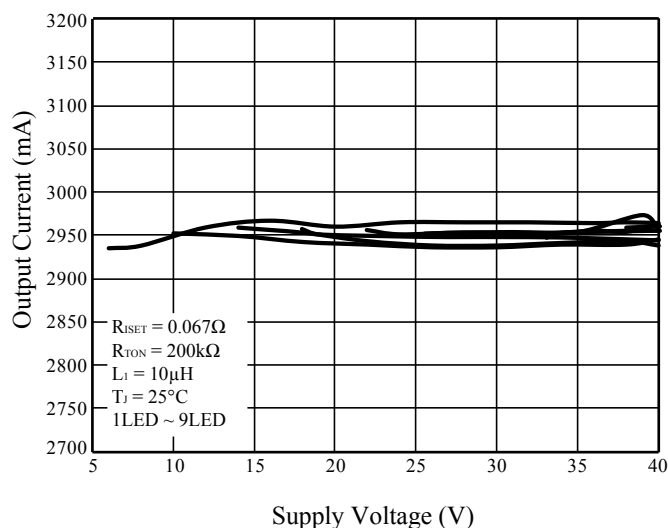
# IS32LT3954A



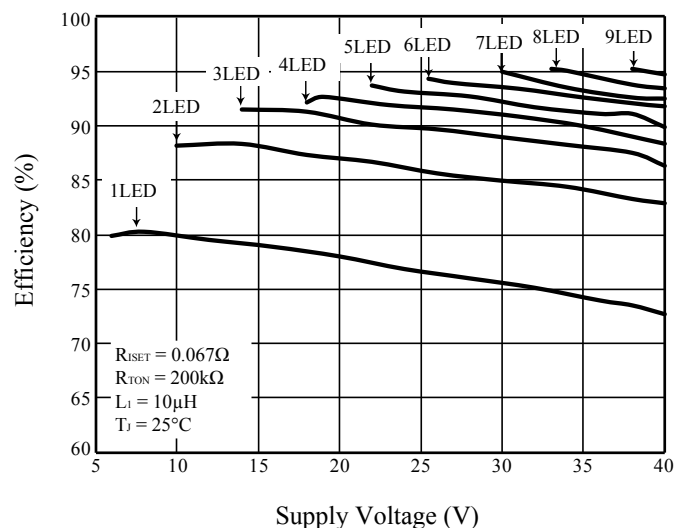
**Figure 9**  $I_{OUT}$  vs.  $V_{CC}$



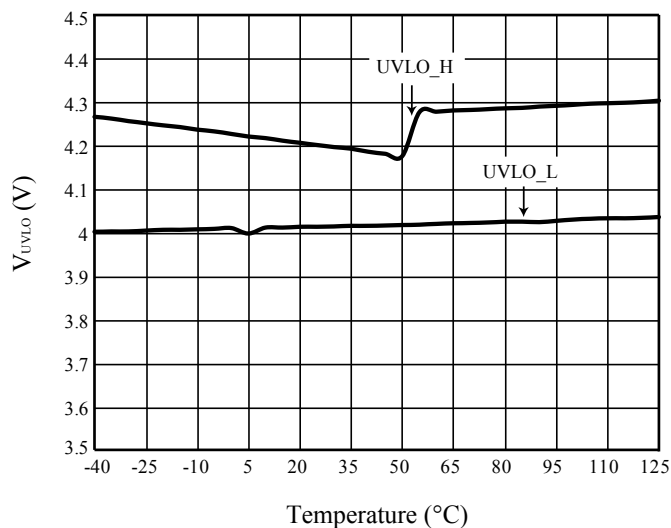
**Figure 10** Efficiency vs.  $V_{CC}$



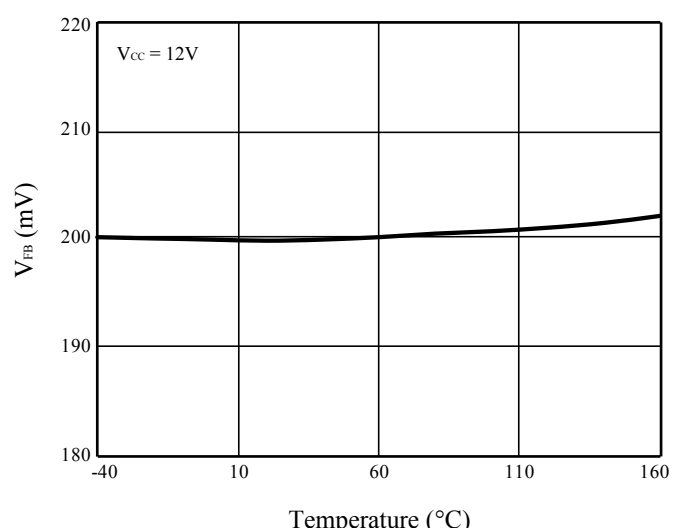
**Figure 11**  $I_{OUT}$  vs.  $V_{CC}$



**Figure 12** Efficiency vs.  $V_{CC}$



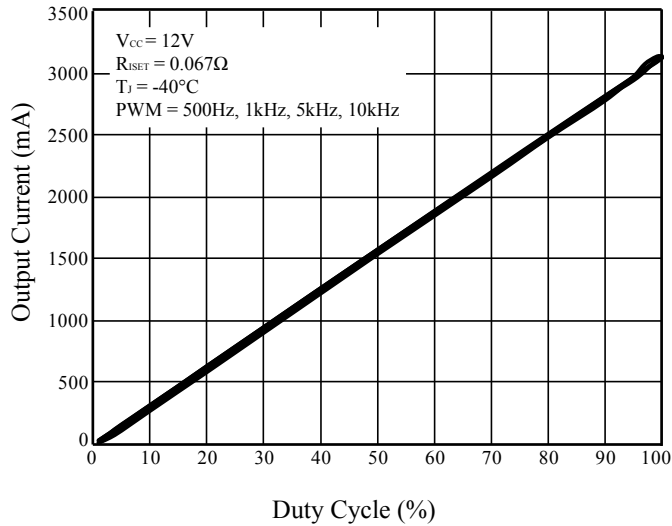
**Figure 13**  $V_{UVLO}$  vs. Temperature



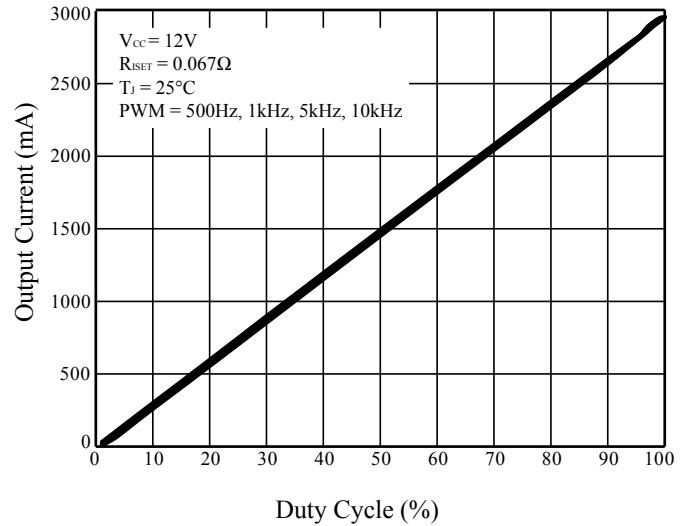
**Figure 14**  $V_{FB}$  vs. Temperature



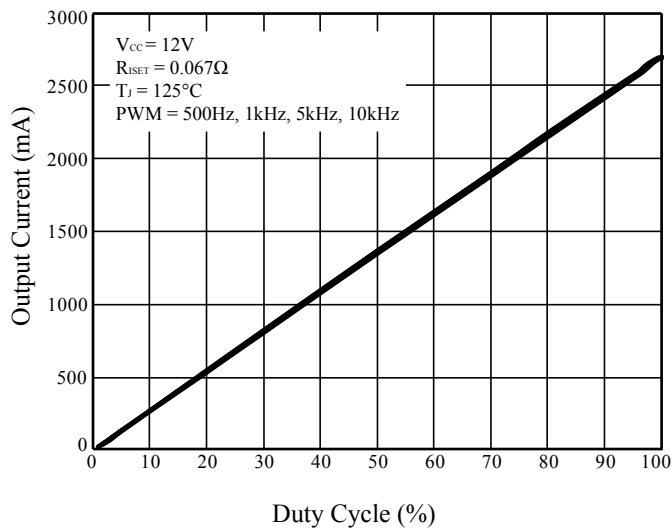
# IS32LT3954A



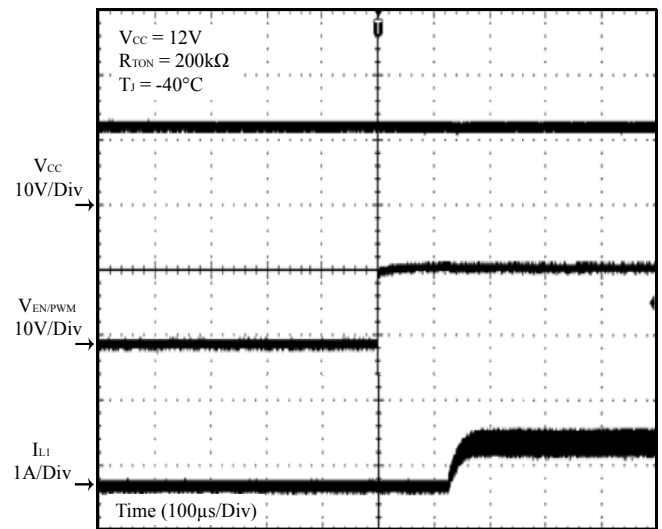
**Figure 15**  $I_{OUT}$  vs. Duty Cycle



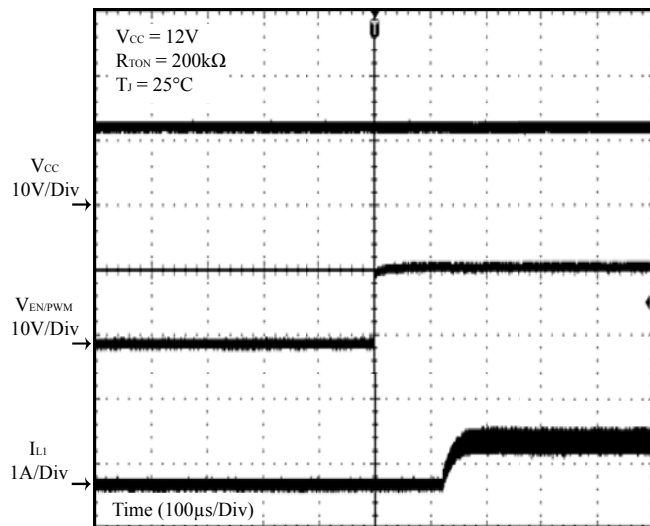
**Figure 16**  $I_{OUT}$  vs. Duty Cycle



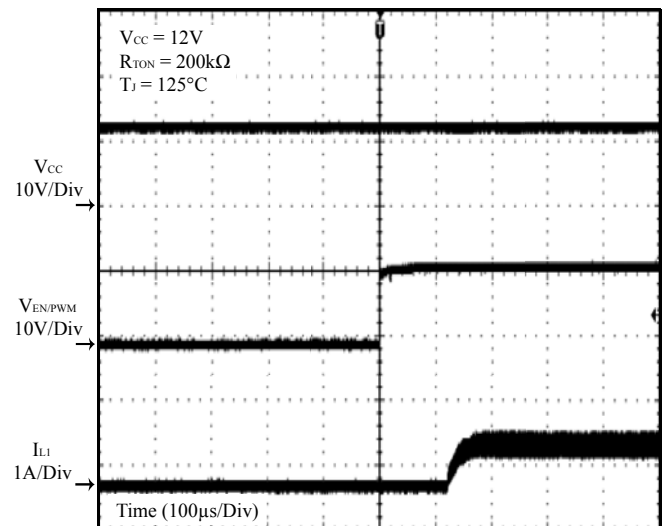
**Figure 17**  $I_{OUT}$  vs. Duty Cycle



**Figure 18** EN/PWM Enable Time

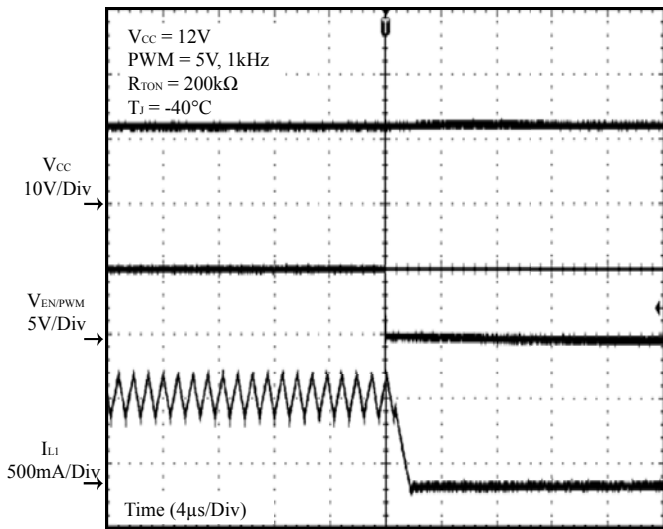


**Figure 19** EN/PWM Enable Time

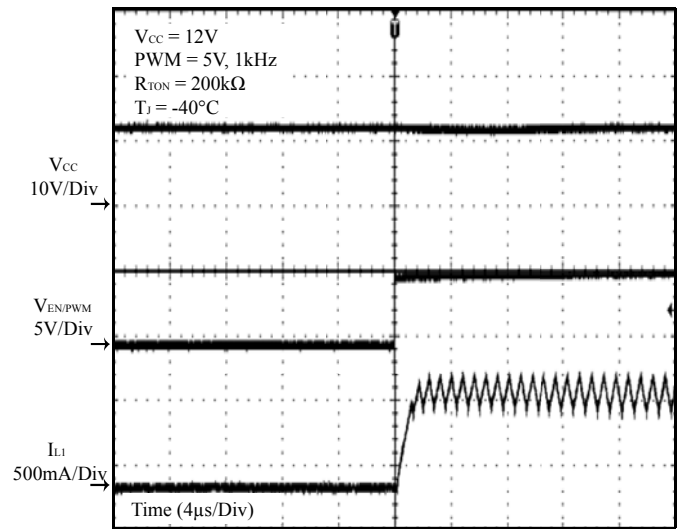


**Figure 20** EN/PWM Enable Time

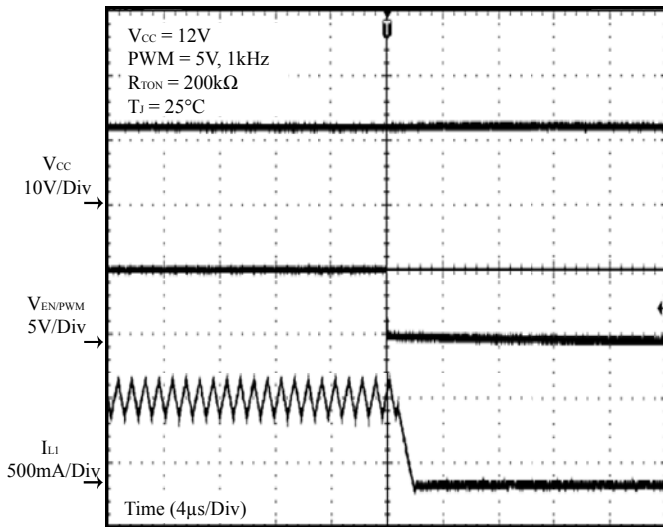
# IS32LT3954A



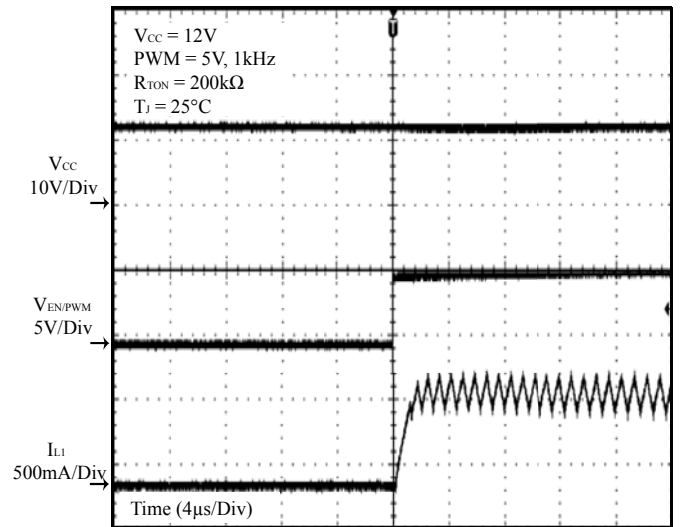
**Figure 21** PWM Off



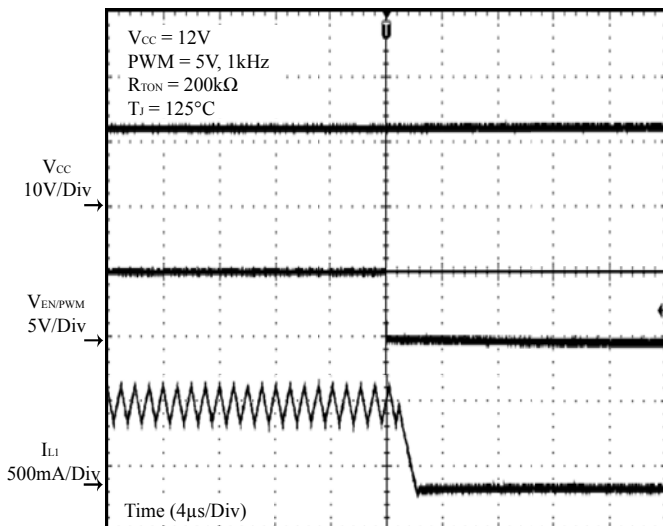
**Figure 22** PWM On



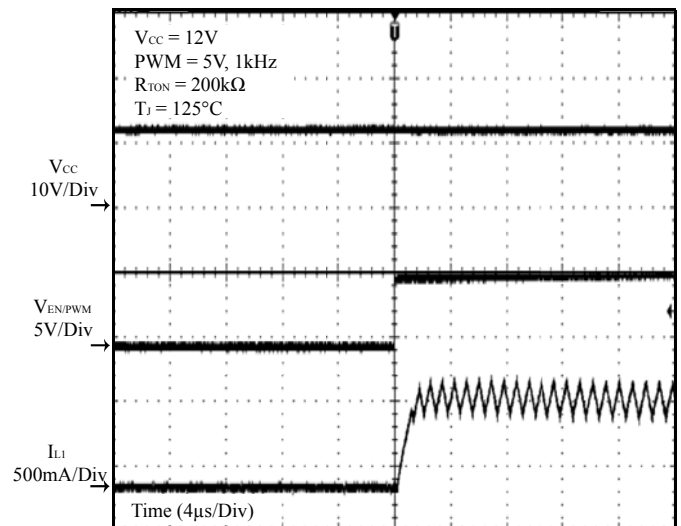
**Figure 23** PWM Off



**Figure 24** PWM On



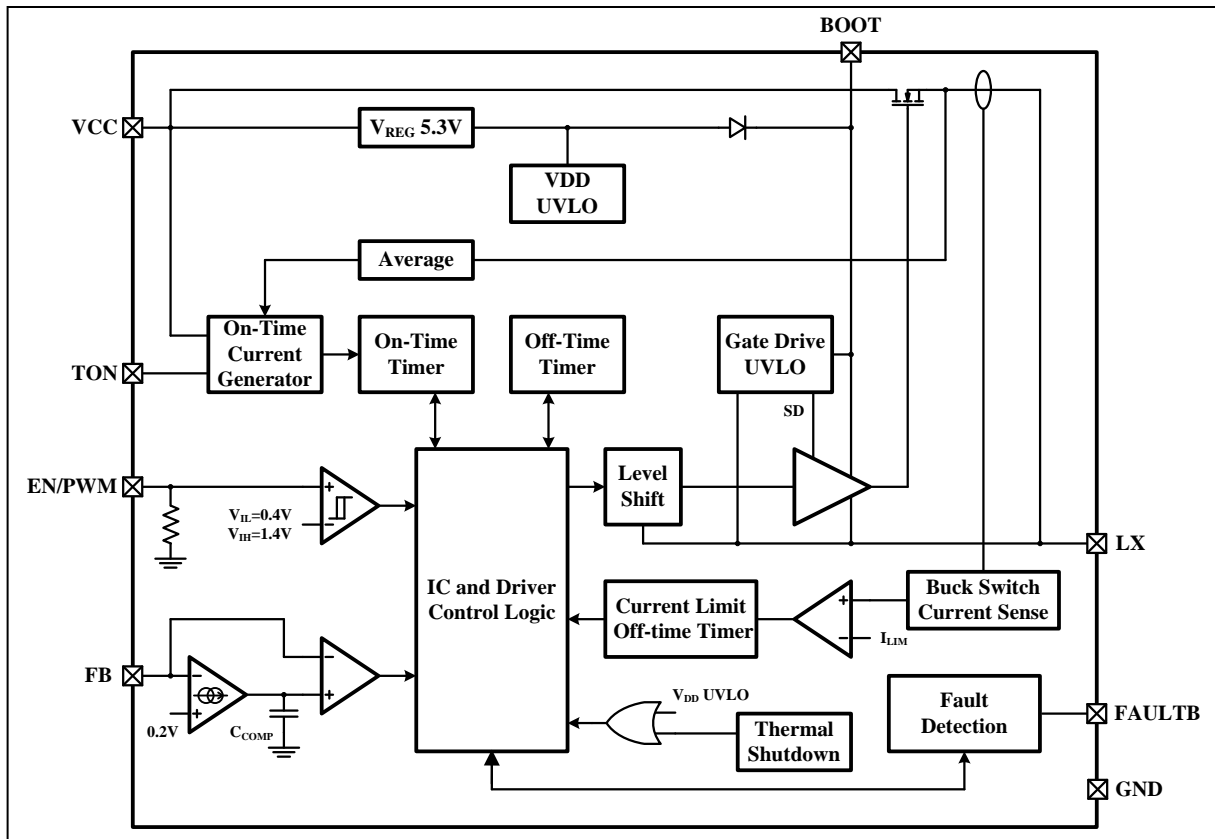
**Figure 25** PWM Off



**Figure 26** PWM On

# IS32LT3954A

## FUNCTIONAL BLOCK DIAGRAM



# IS32LT3954A

## APPLICATION INFORMATION

### DESCRIPTION

The IS32LT3954A is a buck regulator with wide input voltage, low reference voltage, quick output response and excellent PWM dimming performance, which is ideal for driving a high-current LED string. It uses average current mode control to maintain constant LED current and consistent brightness.

### UNDER VOLTAGE LOCKOUT (UVLO)

The device features an under voltage lockout (UVLO) function on VCC pin. This is a fixed value which cannot be adjusted. The device is enabled when the VCC voltage rises to exceed  $V_{UVLO}$  (Typ. 4.25V), and disabled when the VCC voltage falls below  $(V_{UVLO} - V_{UVLO\_HY})$  (Typ. 4.0V).

### BOOTSTRAP CIRCUIT

The gate driver of the integrated high-side MOSFET requires a voltage above VCC as power supply. As below circuit diagram, there is an internal 5.3V LDO which is the power supply of the gate driver. The BOOT pin is internally connected to the output of the 5.3V LDO. Connect a ceramic capacitor between BOOT and SW pins. The VCC supplies the power to the 5.3V LDO which charges the  $C_{BOOT}$  capacitor during high-side MOSFET off cycles. Then in high-side MOSFET on cycles, the  $C_{BOOT}$  charge voltage is used to boost the BOOT pin to 5.3V higher than LX pin.

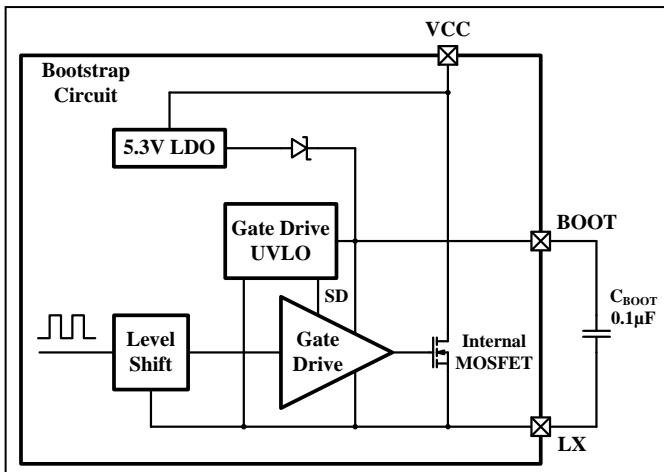


Figure 27 Bootstrap Circuit

A 0.1µF X7R ceramic capacitor will work well in most applications. The gate driver also has an under voltage lockout detection. The gate driver is enabled when the voltage on the  $C_{BOOT}$  rises to above  $V_{BTUV}$  (Typ. 3.3V), and disabled when the voltage on the  $C_{BOOT}$  drops below  $(V_{BTUV} - V_{BTUV\_HY})$  (Typ. 2.9V).

### OUTPUT CURRENT SETTING

The LED current is configured by an external sense resistor,  $R_{ISET}$ , with a value determined as follows Equation (1):

$$I_{LED} = V_{FB} / R_{ISET} \quad (1)$$

Where  $V_{FB} = 0.2V$  (Typ.).

Note that  $R_{ISET} = 0.0667\Omega$  is the minimum allowed value for the sense resistor in order to maintain the switch current below the specified maximum value.

Table 1  $R_{ISET}$  Resistance Versus Output Current

$R_{ISET}$ ( $\Omega$ )	Nominal Average Output Current (mA)
0.2	1000
0.1	2000
0.0667	3000

The resistor  $R_{ISET}$  should be a 1% resistor with enough power tolerance and good temperature characteristic to ensure accurate and stable output current.

### ENABLE AND PWM DIMMING

A high logic signal on the EN/PWM pin will enable the IC. The buck converter ramps up the LED current to a target level which is set by external resistor,  $R_{ISET}$ .

When the EN/PWM pin goes from high to low, the buck converter will turn off, but the IC remains in standby mode for up to  $t_{PWML}$ . When the EN/PWM pin goes high within this period, the LED current will turn on immediately. Sending a PWM (pulse-width modulation) signal to the EN/PWM pin will result in dimming of the LED. The resulting LED brightness is proportional to the duty cycle ( $t_{ON} / T$ ) of the PWM signal. A practical range for PWM dimming frequency is between 100Hz and 20kHz.

There is an inherent PWM turn on delay time of about 1µs during continuous PWM dimming. A high frequency PWM signal has a shorter period time that will degrade the PWM dimming linearity. Therefore, a low frequency PWM signal is good for achieving better dimming contrast ratio. At a 200Hz PWM frequency, the dimming duty cycle can be varied from 100% down to 1% or lower.

If the EN/PWM pin is kept low for at least  $t_{PWML}$ , the IC enters shutdown mode to reduce power consumption. The next high signal on EN/PWM will initialize a full startup sequence, which includes a shutdown quit time,  $t_{PWMLH}$ , and a startup latency,  $t_{PWMSW}$ . This startup sequence does not exist in a typical PWM operation.

# IS32LT3954A

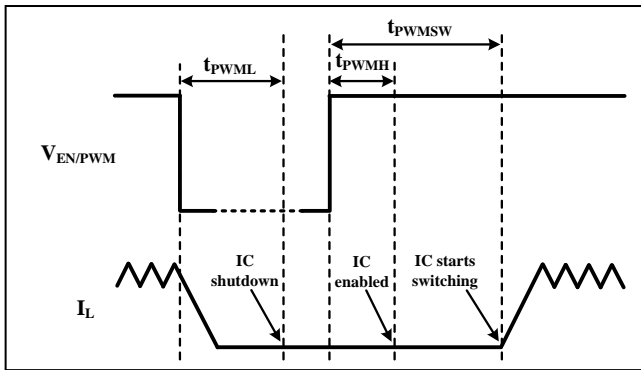


Figure 28 Device shutdown and enable

The EN/PWM pin is high-voltage tolerant and can be connected directly to a power supply. However, a series resistor (10kΩ) is required to limit the current flowing into the EN pin if PWM is higher than the V<sub>CC</sub> voltage at any time. If PWM is driven from a logic input, this series resistor is not necessary.

## INPUT CAPACITOR

The input capacitor provides the transient pulse current, which is approximately equal to I<sub>LED</sub>, to the inductor of the converter when the high-side MOSFET is on. An X7R type ceramic capacitor is a good choice for the input bypass capacitor to handle the ripple current since it has a very low equivalent series resistance (ESR) and low equivalent series inductance (ESL). Use the following equation to estimate the approximate capacitance:

$$C_{IN\_MIN} = \frac{I_{LED} \times t_{ON}}{\Delta V_{CC}} \quad (2)$$

Where, ΔV<sub>CC</sub> is the acceptable input voltage ripple, generally choose 5%-10% of input voltage. t<sub>ON</sub> is on-time of the high-side MOSFET in μs. A minimum input capacitance of 2X C<sub>IN\_MIN</sub> is recommended for most applications.

## OUTPUT CAPACITOR

The IS32LT3954A control loop can accept a voltage ripple on the FB pin, this means it can operate without an output capacitor to save cost. The FB pin needs a certain amount of voltage ripple to keep control loop stability. A capacitor can be added across the LEDs but excluding the FB resistor. This capacitor will reduce the LED current ripple while keep the same average current in some application cases. The reduction of the LED current ripple by the capacitor depends on several factors: capacitor value, inductor current ripple, operating frequency, output voltage, etc. A several μF capacitor is sufficient for most applications. However, the output capacitor brings in more delay time of LED current during PWM dimming that will degrade the dimming contrast.

The output capacitor is used to filter the LED current ripple to an acceptable level. The equivalent series resistance (ESR), equivalent series inductance (ESL)

and capacitance of the capacitor contribute to the output current ripple. Therefore, a low-ESR X7R type capacitor should be used.

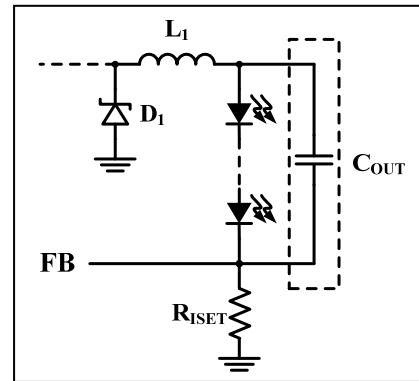


Figure 29 Adding Output Capacitor

## FREQUENCY SELECTION

During switching the IS32LT3954A operates in a constant on-time mode. The on-time is adjusted by the external resistor, R<sub>TON</sub>, which is connected between the V<sub>CC</sub> and TON pins.

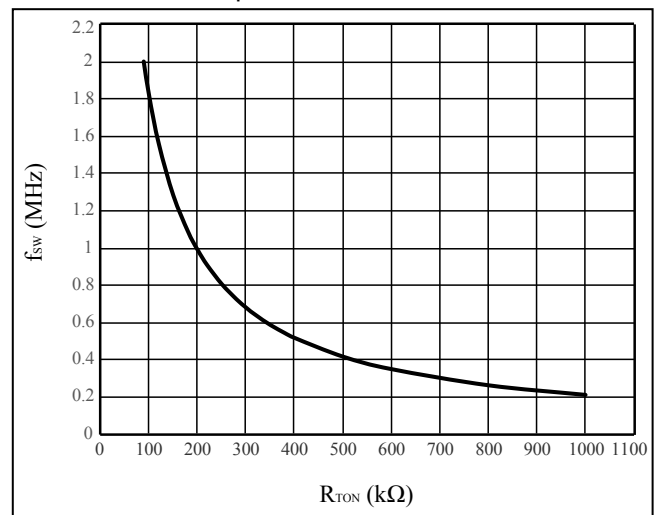


Figure 30 Operating Frequency vs. R<sub>TON</sub> Resistance

The approximate operating frequency can be calculated by below Equation (3) and (4):

$$t_{ON} = \frac{k \times (R_{TON} + R_{INT}) \times V_{OUT}}{V_{CC}} \quad (3)$$

$$f_{SW} = \frac{1}{k \times (R_{TON} + R_{INT})} \quad (4)$$

Where k= 0.00458, with f<sub>SW</sub> in MHz, t<sub>ON</sub> in μs, and R<sub>TON</sub> and R<sub>INT</sub> (internal resistance, 20kΩ) in kΩ.

Higher frequency operation results in smaller component size but increases the switching losses. It may also increase the high-side MOSFET gate driving current and may not allow sufficient high or low duty cycle. Lower frequency gives better performance but results in larger component size.

# IS32LT3954A

## SPREAD SPECTRUM

A switch mode controller can be troublesome when the EMI is concerned. To optimize the EMI performance, the IS32LT3954A includes a spread spectrum feature, which is a 500Hz with  $\pm 10\%$  operating frequency jitter. The spread spectrum can spread the total electromagnetic emitting energy into a wider range that significantly degrades the peak energy of EMI. With spread spectrum, the EMI test can be passed with smaller size and lower cost filter circuit.

## MINIMUM AND MAXIMUM OUTPUT VOLTAGE

The output voltage of a buck converter is approximately given as below:

$$V_{OUT} = V_{CC} \times D \quad (5)$$

Where D is the operating duty cycle.

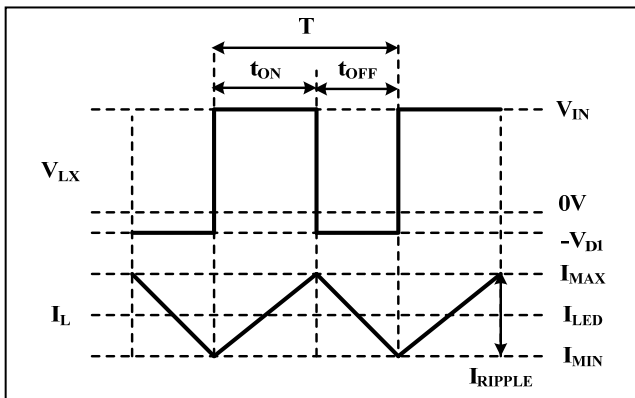


Figure 31 Operating Waveform

$$D = \frac{t_{ON}}{t_{ON} + t_{OFF}} \quad (6)$$

$$\text{So, } V_{OUT} = V_{CC} \times \frac{t_{ON}}{t_{ON} + t_{OFF}} = V_{CC} \times t_{ON} \times f_{SW} \quad (7)$$

Where  $t_{ON}$  and  $t_{OFF}$  are the turn-on and turn off time of high-side MOSFET. Note that due to the spread spectrum, the  $f_{SW}$  should use the maximum of the operating frequency,  $110\% \times f_{SW}$ .

According to above equation, the output voltage depends on the operating frequency and the high-side MOSFET turn on time. When the frequency is set, the maximum output voltage is limited by the switching minimum off-time  $t_{OFF\_MIN}$ , about 150ns. For example, if the input voltage is 12V and the operating frequency  $f_{SW}=1\text{MHz}$ , the maximum output voltage is:

$$V_{OUT} = 12V \times (1\mu s - 150ns) \times 1\text{MHz} = 10.2V \quad (8)$$

Assume the forward voltage of each LED is 3.2V, the device can drive up to 3 LEDs in series.

The minimum output voltage is limited by the switching minimum on-time, about 150ns, since the frequency is set. For example, if the input voltage is 12V and the operating frequency  $f_{SW}=1\text{MHz}$ , the minimum output voltage is:

$$V_{OUT} = 12V \times 150ns \times 1\text{MHz} = 1.8V \quad (9)$$

This means the device can drive a low forward voltage LED, such as a RED color LED. So under the condition of  $V_{CC}=12V$  and  $f_{SW}=1\text{MHz}$ , the output voltage range is 1.8V~10.2V. Exceeding this range, the operation will be clamped and the output current cannot reach the set value.

In a typical application, the output voltage is affected by other operating parameters, such as output current,  $R_{DS\_ON}$  of the high-side MOSFET, DRC of the inductor, parasitic resistance of the PCB traces, and the forward voltage of the diode. Therefore, the output voltage range could vary from the calculation. The more precision equation is given by:

$$V_{OUT} = (V_{CC} - I_{LED} \times R_{DS\_ON}) \times D - R_L \times I_{LED} - V_D \times (1 - D) \quad (10)$$

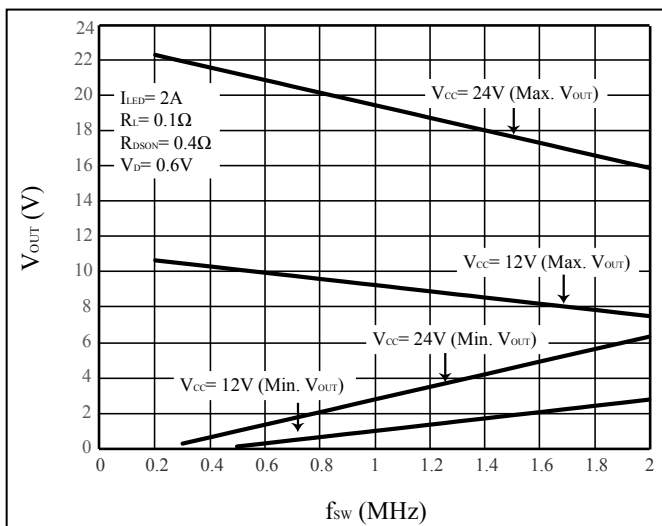
Where,  $R_{DS\_ON}$  is the static drain-source on resistance of the high-side MOSFET, and  $R_L$  is the inductor DC resistance.

Figure 32 shows how the minimum and maximum output voltages vary with the operating frequency at 12V and 24V input. Figure 33 shows how the minimum and maximum output voltages vary with the LED current at 9V input (assuming  $R_{DS\_ON} = 0.4\Omega$ , inductor DCR  $R_L = 0.1\Omega$ , and diode  $V_D = 0.6V$ ). Note that due to spread spectrum the  $f_{SW}$  should use the maximum operating frequency,  $110\% \times f_{SW}$ .

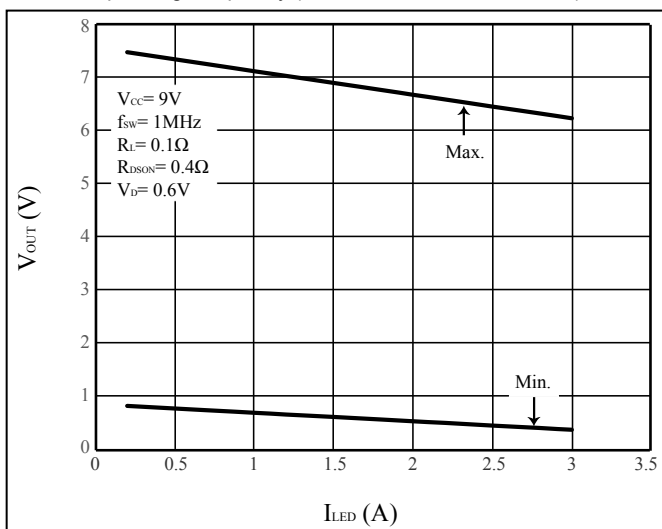
When the output voltage is lower than the minimum  $t_{ON}$  time of the device, the device will automatically extend the operating  $t_{OFF}$  time to maintain the set output LED current all the time. However, the operating frequency will decrease accordingly to lower level to keep the duty cycle in correct regulating.

To achieve wider output voltage range and flexible output configuration, a lower operating frequency could be considered.

# IS32LT3954A



**Figure 32** Minimum and Maximum Output Voltage versus Operating Frequency (minimum  $t_{ON}$  and  $t_{OFF}$  = 150ns)



**Figure 33** Minimum and Maximum Output Voltage versus LED Current (minimum  $t_{ON}$  and  $t_{OFF}$  = 150ns)

## PEAK CURRENT LIMIT

To protect itself, the IS32LT3954A integrates an Over Current Protection (OCP) detection circuit to monitor the current through the high-side MOSFET during switching on. Whenever the current exceeds the OCP current threshold,  $I_{SWLIM}$ , the device will immediately turn off the high-side MOSFET for  $t_{OCP}$  and restart again. The device will remain in this hiccup mode until the current drops below  $I_{SWLIM}$ .

## INDUCTOR

Inductor value involves trade-offs in performance. A larger inductance reduces inductor current ripple, however it also brings in unwanted parasitic resistance that degrades the efficiency. A smaller inductance has compact size and lower cost, but introduces higher ripple in the LED string. Use the following equation to estimate the approximate inductor value:

$$L = \frac{(V_{CC} - V_{LED}) \times V_{LED}}{f_{SW} \times \Delta I_L \times V_{CC}} \quad (11)$$

Where  $V_{CC}$  is the minimum input voltage in volts,  $V_{LED}$  is the total forward voltage of LED string in volts,  $f_{SW}$  is the operation frequency in hertz and  $\Delta I_L$  is the current ripple in the inductor. Select an inductor with a rated current greater than the output average current and the saturation current over the Over Current Protection (OCP) current threshold  $I_{SWLIM}$ .

Since the IS32LT3954A is a Continuous Conduction Mode (CCM) buck driver which means the valley of the inductor current,  $I_{MIN}$ , should not drop to zero at any time, the  $\Delta I_L$  must be smaller than 200% of the average output current.

$$I_{MIN} = I_{LED} - \frac{\Delta I_L}{2} > 0 \quad (12)$$

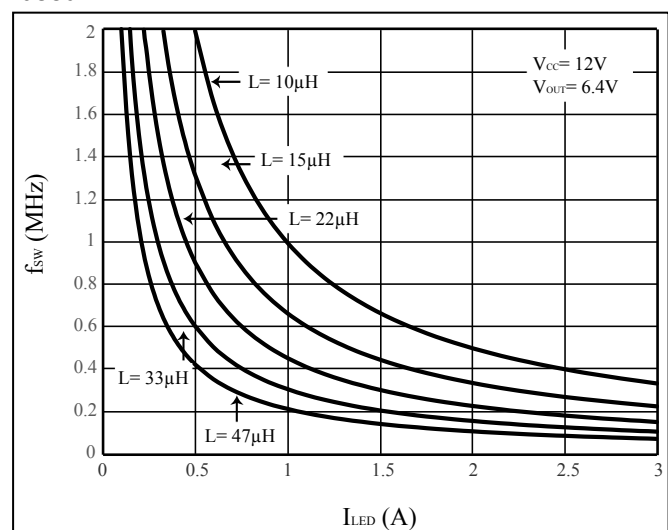
Besides, the peak current of the inductor,  $I_{MAX}$ , must be smaller than  $I_{SWLIM}$  to prevent the IS32LT3954A from triggering OCP, especially when the output current is set to a high level.

$$I_{MAX} = I_{LED} + \frac{\Delta I_L}{2} < I_{SWLIM} \quad (13)$$

To ensure system stability, the  $\Delta I_L$  must be higher than 10% of the average output current. For the better performance, choose an inductor current ripple  $\Delta I_L$  between 10% and 50% of the average output current.

$$0.1 \times I_{LED} \leq \Delta I_L \leq 0.5 \times I_{LED} \quad (14)$$

Figure 34 shows inductor selection based on the operating frequency and LED current at 30% inductor current ripple. If a lower operating frequency is used, either a larger inductance or current ripple should be used.



**Figure 34** Inductance Selection Based On 30% Current Ripple

# IS32LT3954A

## DIODE

The IS32LT3954A is a non-synchronous buck driver that requires a recirculating diode to conduct the current during the high-side MOSFET off time. The best choice is a Schottky diode due to its low forward voltage, low reverse leakage current and fast reverse recovery time. The diode should be selected with a peak current rating above the inductor peak current and a continuous current rating higher than the maximum output load current. It is very important to consider the reverse leakage of the diode when operating at high temperature. Excess leakage will increase the power dissipation on the device.

The higher input voltage and the voltage ringing due to the reverse recovery time of the Schottky diode will increase the peak voltage on the LX output. If a Schottky diode is chosen, care should be taken to ensure that the total voltage appearing on the LX pin including supply ripple, does not exceed its specified maximum value.

## THERMAL SHUTDOWN PROTECTION

To protect the IC from damage due to high power dissipation, the temperature of the die is monitored. If the die temperature exceeds the thermal shutdown temperature of 165°C (Typ.) then the device will shut down, and the output current is shut off and FAULTB pin pulls low. After a thermal shutdown event, the IS32LT3954A will not try to restart until its temperature has reduced to less than 140°C (Typ.). Once restart, the FAULTB pin will recover.

## FAULT HANDLING

The IS32LT3954A is designed to detect the following faults and report via open drain FAULTB pin:

- Pin open
- Pin-to-ground short (except LX pin)
- Pin-to-neighboring pin short
- Output LED string open and short
- External component open or short (except diode)
- Thermal shutdown

Please check Table 2 for the details of the fault actions.

## FAULTB PARALLEL INTERCONNECTION

FAULTB is a fault reporting output pin and as well as an input pin. Externally pulling FAULTB pin low will disable the output. For lighting systems with multiple IS32LT3954A drivers which require the complete lighting system be shut down when a fault is detected, the FAULTB pin can be used in a parallel connection as shown in Figure 2. A fault output by one device will pull low the FAULTB pins of the other parallel connected devices and simultaneously turn them off. This satisfies the “One-Fail-All-Fail” operating requirement. Note that the FAULTB pin is an open drain structure. An external pull up resistor to FAULTB pin is needed. The recommended value is 47kΩ.

## CALCULATING RANGE OF R<sub>PU</sub>

The IS32LT3954A will drive the FAULTB pin low when it detects a fault condition (Table 2). The FAULTB pin is an open drain output which is not allowed to float. Therefore a pullup resistor R<sub>PU</sub> is required to maintain a system-wide high logic level during normal operation (no fault detected).

The ideal value for R<sub>PU</sub> range needs to take into account the number of IS32LT3954A devices with their FAULTB pins interconnected. The resulting R<sub>PU</sub> voltage level should not interfere with the V<sub>FAULTB\_IH</sub> and V<sub>FAULTB\_IL</sub> detection levels. For no-fault detected operation, the sum of the leakage current(s) for the open drain (if more than one device interconnected) multiplied with the value of R<sub>PU</sub> must be greater than V<sub>FAULTB\_IH</sub>. Assuming two IS32LT3954A devices interconnected, then

$$R_{PU\_MAX} = \frac{V_{CC} - V_{FAULTB\_IH}}{N \times I_{LK\_FAULTB}} \quad (15)$$

$$R_{PU\_MIN} = \frac{(V_{CC} - V_{FAULTB\_IL}) \times V_{FAULTB}}{V_{FAULTB\_IL} \times I_{OL}} \quad (16)$$

Where N is the number of IS32LT3954A devices connected to the same host. I<sub>OL</sub> is the test condition of FAULTB pin pull down capability. It can be found in the EC table.



# IS32LT3954A

**Table 2 Fault Actions**

Fault Type	LED String	Detect Condition		FAULTB Pin		Fault Recovering
Inductor shorted	Dim	Trigger OCP. Turn off high-side MOSFET immediately. Retry after 1ms.		Pull Low after second OCP cycle.		Inductor shorted removed. No OCP triggered and FAULTB pin recover after 10ms.
R <sub>ISET</sub> short	Dim	Trigger OCP. Turn off high-side MOSFET immediately. Retry after 1ms.		Pull Low after second OCP cycle.		R <sub>ISET</sub> shorted removed. No OCP triggered and FAULTB pin recover after 10ms.
R <sub>ISET</sub> open	Off	The FB pin voltage exceeds 2V. Turn off high-side MOSFET immediately. Retry after 1ms.		Pull Low immediately.		R <sub>ISET</sub> open removed. The FB pin voltage drops below 1.55V and FAULTB pin recover after 10ms.
LED string open	Off	No PWM dimming:	FB pin average voltage drops below 0.2V for 10ms.	No PWM dimming:	Pull Low after 10ms.	LED open removed. FB average voltage keep at 0.2V for 10ms and FAULTB pin recover.
		PWM dimming:	FB pin average voltage drops below 0.2V after 25 $\mu$ s deglitch time and keeps for 128 PWM cycles.	PWM dimming:	Pull low after 128 PWM cycles or the on-time over 20 $\mu$ s.	
LED string shorted	Off	No PWM dimming:	Filter V <sub>LX</sub> to get V <sub>OUT</sub> , if V <sub>OUT</sub> <1V for 10ms	No PWM dimming:	Pull Low after 10ms.	Shorted removed. V <sub>OUT</sub> >1V for 10ms and FAULTB pin recover.
		PWM dimming:	Filter V <sub>LX</sub> to get V <sub>OUT</sub> , if V <sub>OUT</sub> <1V after 25 $\mu$ s deglitch time and keeps for 128 PWM cycles.	PWM dimming:	Pull low after 128 PWM cycles.	
LED string shorted to GND	Off	Trigger OCP. Turn off high-side MOSFET immediately. Retry after 1ms.		Pull Low after second OCP cycle.		Shorted removed. No OCP triggered and FAULTB pin recover after 10ms.
BOOT capacitor open	Dim	V <sub>CC</sub> -V <sub>SW</sub> >1.8V at high-side MOSFET ON (High-side can't fully turn on). Turn off high-side MOSFET immediately. Retry after 1ms.		Pull Low immediately		BOOT capacitor open removed, V <sub>CC</sub> -V <sub>SW</sub> <1.8V for 10ms and FAULTB pin recover.
BOOT capacitor shorted	Off	Bootstrap circuit UVLO and turn off high-side MOSFET immediately.		No PWM dimming:	Pull Low after 10ms.	BOOT capacitor shorted removed. Release from UVLO and FAULTB pin recover after 10ms
				PWM dimming:	Pull low after 128 PWM cycles.	
R <sub>TON</sub> resistor open	Dim	On-time exceeds 20 $\mu$ s or trigger OCP, then turn off high-side MOSFET immediately. Retry after 1ms.		Pull Low after 20 $\mu$ s or second OCP cycle.		R <sub>TON</sub> resistor open removed. No over 20 $\mu$ s on-time or OCP triggered. FAULTB pin recover after 10ms
R <sub>TON</sub> resistor shorted	Dim	The device operating at minimum on/off time, maybe trigger the other fault conditions.		No reporting		R <sub>TON</sub> resistor shorted removed.
EN short to R <sub>ISET</sub>	Off	EN/PWM will be pulled low by R <sub>ISET</sub> resistor.		No reporting		EN short to R <sub>ISET</sub> removed.
Thermal Shutdown	Off	The die temperature exceeds 165°C		Pull low immediately		The die temperature cools down below 140°C. FAULTB pin recovers immediately.

# IS32LT3954A

## LAYOUT CONSIDERATIONS

As for all switching power supplies, especially those providing high current and using high switching frequencies, layout is an important design step. If layout is not carefully done, the operation could show instability as well as EMI problems.

The high dV/dt surface and dI/dt loops are big noise emission source. To optimize the EMI performance, keep the area size of all high switching frequency points with high voltage compact. Meantime, keep all traces carrying high current as short as possible to minimize the loops.

- (1) Wide traces should be used for connection of the high current paths that helps to achieve better efficiency and EMI performance. Such as the traces of power supply, inductor L<sub>1</sub>, current recirculating diode D<sub>1</sub>, LED load and ground.
- (2) Keep the traces of the switching points shorter. The inductor L<sub>1</sub>, LX and current recirculating diode D<sub>1</sub> should be placed as close to each other as possible and the traces of connection between them should be as short and wide as possible.
- (3) To avoid the ground jitter, the components of parameter setting, R<sub>1SET</sub>, should be placed close to the device and keep the traces length to the device pins as short as possible. On the other side, to prevent the noise coupling, the traces of R<sub>1SET</sub> should either be far away or be isolated from high-current paths and high-speed switching nodes. These practices are essential for better accuracy and stability.
- (4) The capacitor C<sub>IN</sub> should be placed as close as possible to VCC pin for good filtering.
- (5) Place the bootstrap capacitor C<sub>BOOT</sub> close to BOOT pin and LX pin to ensure the traces as short as possible.
- (6) The connection to the LED string should be kept short to minimize radiated emission. In practice, if the LED string is far away from the driver board, an output capacitor is recommended to be used and placed on driver board to reduce the current ripple in the connecting wire.
- (7) The thermal pad on the back of device package must be soldered to a sufficient size of copper ground plane with sufficient vias to conduct the heat to opposite side PCB for adequate cooling.

## THERMAL CONSIDERATIONS

The package thermal resistance,  $\theta_{JA}$ , determines the amount of heat that can pass from the silicon die to the surrounding ambient environment. The  $\theta_{JA}$  is a measure of the temperature rise created by power dissipation and is usually measured in degree Celsius per watt ( $^{\circ}C/W$ ).

When operating the chip at high ambient temperatures, or when driving maximum load current, care must be taken to avoid exceeding the package power dissipation limits. The maximum power dissipation can be calculated using the following Equation (17):

$$P_{D(MAX)} = \frac{T_{J(MAX)} - T_A}{\theta_{JA}} \quad (17)$$

Where T<sub>J(MAX)</sub> is the recommended maximum operating junction temperature.

$$\text{So, } P_{D(MAX)} = \frac{125^{\circ}C - 25^{\circ}C}{42.7^{\circ}C/W} \approx 2.34W$$

Figure 35, shows the power derating of the IS32LT3954A on a JEDEC boards (in accordance with JESD 51-5 and JESD 51-7) standing in still air.

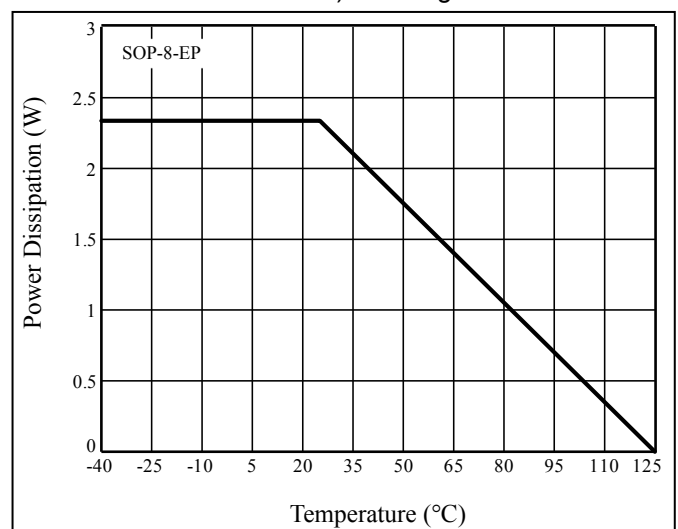


Figure 35 Dissipation Curve

The thermal resistance is achieved by mounting the IS32LT3954A on a standard FR4 double-sided printed circuit board (PCB) with a copper area of a few square inches on each side of the board under the IS32LT3954A. Multiple thermal vias, as shown in Figure 36, help to conduct the heat from the exposed pad of the IS32LT3954A to the copper on each side of the board. The thermal resistance can be reduced by using a metal substrate or by adding a heatsink.

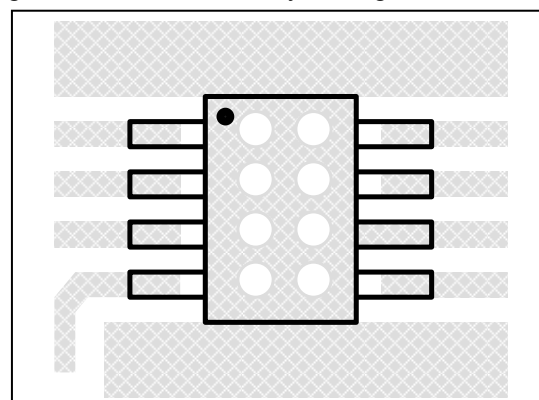


Figure 36 Board Via Layout For Thermal Dissipation

# IS32LT3954A

## CLASSIFICATION REFLOW PROFILES

Profile Feature	Pb-Free Assembly
<b>Preheat &amp; Soak</b> Temperature min (T <sub>smin</sub> ) Temperature max (T <sub>smax</sub> ) Time (T <sub>smin</sub> to T <sub>smax</sub> ) (t <sub>s</sub> )	150°C 200°C 60-120 seconds
Average ramp-up rate (T <sub>smax</sub> to T <sub>p</sub> )	3°C/second max.
Liquidous temperature (T <sub>L</sub> ) Time at liquidous (t <sub>L</sub> )	217°C 60-150 seconds
Peak package body temperature (T <sub>p</sub> )*	Max 260°C
Time (t <sub>p</sub> )** within 5°C of the specified classification temperature (T <sub>c</sub> )	Max 30 seconds
Average ramp-down rate (T <sub>p</sub> to T <sub>smax</sub> )	6°C/second max.
Time 25°C to peak temperature	8 minutes max.

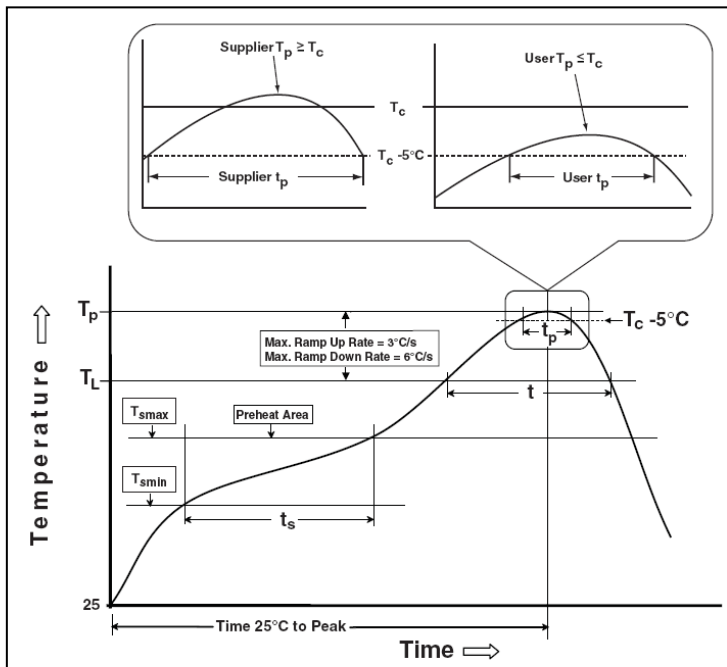
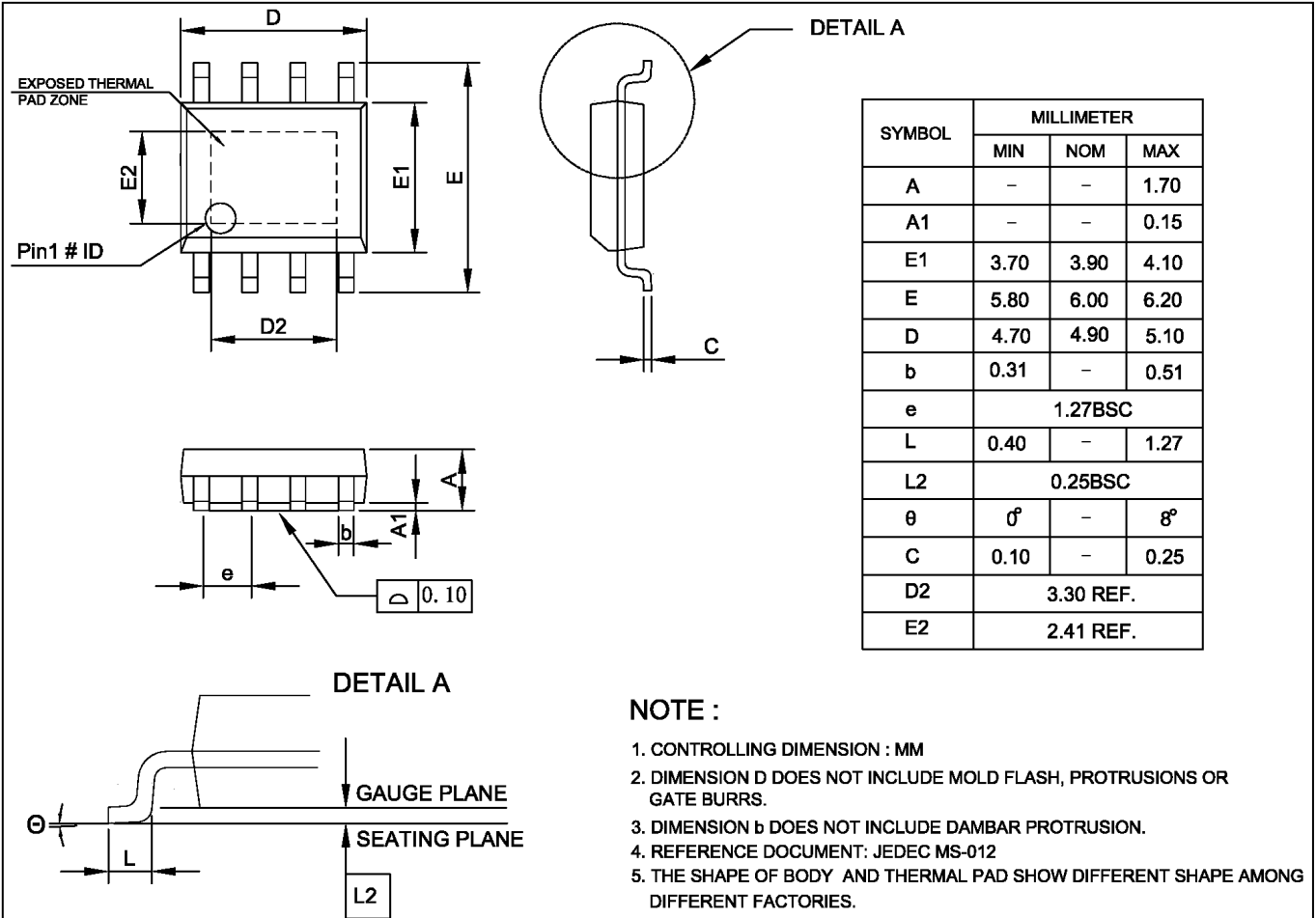


Figure 37 Classification Profile

# IS32LT3954A

## PACKAGE INFORMATION

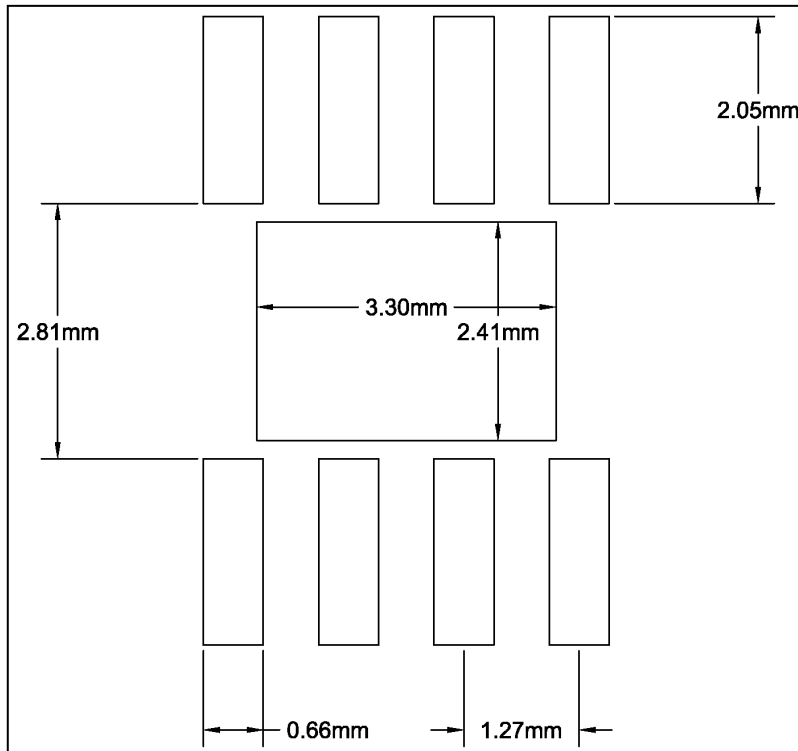
### SOP-8-EP



# IS32LT3954A

## RECOMMENDED LAND PATTERN

### SOP-8-EP




#### Note:

1. Land pattern complies to IPC-7351.
2. All dimensions in MM.
3. This document (including dimensions, notes & specs) is a recommendation based on typical circuit board manufacturing parameters. Since land pattern design depends on many factors unknown (eg. user's board manufacturing specs), user must determine suitability for use.

# IS32LT3954A



A Division of 

## REVISION HISTORY

Revision	Detail Information	Date
0A	Initial release	2019.12.25
A	Update final version	2020.04.09