

LYT7503-7504 LYTSwitch-7 Family

Phase-Cut Dimmable Single-Stage LED Driver IC with Combined PFC and Constant Current Output for Buck Topology

Product Highlights

Single-Stage PFC + Accurate CC Output

- $\pm 3\%$ CC regulation in single line input voltage applications
- Power factor >0.9
- High efficiency $>85\%$
- Robust 725 V MOSFET for increased line voltage surge resistance
- Critical Conduction Mode (CrM) buck
- Low EMI
- Excellent line noise and transient rejection

Dimming Highlights

- Fast turn-on (<500 ms)
- Low pop-on
- Better than 10:1 dimming ratio
- Simple passive R-C damper
- Monotonic dimming profile

Design Flexibility

- Wide input (90 VAC – 308 VAC) and output voltage range operation
- 2 family members cover power range for optimum device selection
- Requires no inductor bias winding
- Small form factor package – SO-8

Highest Reliability

- Industry's lowest component count dimming solution
- Comprehensive protection features with auto-restart
 - Input and output overvoltage protection (OVP)
 - Output short-circuit protection
 - Open-loop protection
- Advanced thermal control
 - Thermal foldback ensures that light continues to be delivered at elevated temperatures
 - Over-temperature shutdown provides protection during fault conditions

Description

The LYTSwitch™-7 family is ideal for single-stage, high PF, constant current LED dimmable applications.

The family incorporates a high-voltage MOSFET with a variable on-time CrM controller. Extensive protection features with minimum external components provide industry leading power density and functionality.

The CrM operation results in low turn-on losses and reduces cost of output diode (slower reverse-recovery type can be used).

LYTSwitch-7 devices are suitable for applications from 4 W to 22 W. See Graph 1 for selection guidance (based on typical inductance). For more information, see Application section. LYTSwitch-7 peak current mode operation is suitable for TRIAC applications without the need for an active bleeder.



Figure 2. SO-8 D Package.

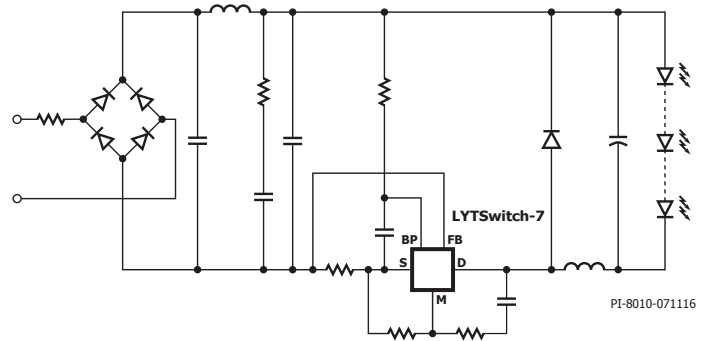
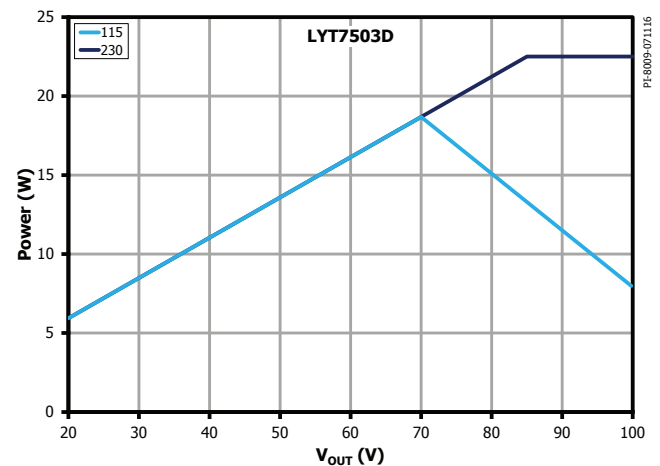
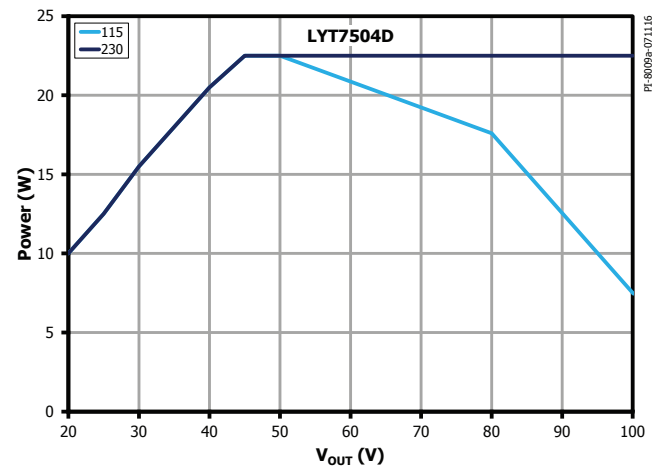

Figure 1. Buck – Typical Application Schematic.



Graph 1. Output Power Graph^(1,2) (Buck Topology).

Notes:

1. Maximum practical continuous power in an open frame design with adequate heat sinking, measured at 50°C ambient.
2. Output power graph based on typical values for inductance, $I_{LIMIT(ARY)}$, $T_{ON(MAX)}$ and package thermal limits.

R4. The voltage drop is compared to an internal 279 mV (typical) reference voltage ($V_{FB(REF)}$). The value for RFB can be calculated from the equation:

$$R_{FB} = V_{FB(REF)} / k \times I_{OUT}$$

Where: $k = 3.6$ which is the ratio of $I_{PK} : I_{OUT}$

Trimming RFB may be necessary to center I_{OUT} to the nominal LED output voltage.

The MULTIFUNCTION (M) pin detects AC line overvoltage events. When the internal MOSFET is in on-state, the MULTIFUNCTION pin is internally connected to the SOURCE (S) pin and can detect the rectified input line voltage which is the voltage across the inductor, i.e. ($V_{IN} - V_{OUT}$) and current flowing out of the MULTIFUNCTION pin is set by resistor R5. The line overvoltage trigger point (V_{LINE_OV}) is calculated by;

$$V_{LINE(OVP)} = I_{IOV} \times R5 + V_{OUT}$$

R9 is assumed to be $402 \text{ k}\Omega \pm 1\%$.

Once the detected current exceeds the input overvoltage threshold ($I_{IOV} = 1 \text{ mA}$ typical), the IC will instantaneously inhibit switching and initiate auto-restart to protect the internal MOSFET and the LED load from voltage overstress.

The MULTIFUNCTION pin also monitors the output for overvoltage or undervoltage events. When the internal MOSFET is in off-state, the output voltage is sensed via divider resistors R5 and R9 across the inductor voltage of T1. When an output open-load condition occurs, the voltage at the MULTIFUNCTION pin will rise abruptly. When it exceeds the V_{OV} threshold of 2.4 V (typical), the IC will inhibit switching and initiate an auto-restart to prevent the output voltage from rising further. The overvoltage cut-off is typically set at 120% of the output voltage, which is equivalent to 2 V on the MULTIFUNCTION pin

$$V_{OUT(OVP)} = V_{OUT} \times 2.4 \text{ V} / 2 \text{ V}$$

If desired, a higher overvoltage cut-off can be selected by setting a lower MULTIFUNCTION pin voltage target. Resistor R9 is a fixed value of $402 \text{ k}\Omega \pm 1\%$ allowing R5 to determine the output overvoltage limit.

A short-circuit at the output will reduce output voltage and be detected when the MULTIFUNCTION pin voltage falls below the undervoltage threshold ($V_{UV} = 1 \text{ V}$ typical). The IC will inhibit switching and initiate auto-restart limiting the average input power to less than 1 W, preventing any component from overheating during a short-circuit.

Resistor R5 can be calculated as follows;

$$R5 = 2 \text{ V} \times R9 / (V_{OUT} - 2 \text{ V})$$

A small capacitor C5 is needed to couple the high-side referenced analog of the output voltage to the MULTIFUNCTION pin of the IC via resistor divider network R5 and R9. Calculation and practical experience shows that, a capacitance value of 100 pF provides a good compromise between AC line rejection and flatness of the output voltage during the off-time of the switch.

Another function of the MULTIFUNCTION pin is for zero current detection (ZCD). Detecting this condition is necessary for operation in critical conduction mode (CrM). Inductor demagnetization is detected when the voltage across the inductor begins to collapse as flywheel diode (D1) conduction ends.

Output Stage

During the MOSFET-switch off-state, free-wheeling diode D1 rectifies and conducts the voltage across T1 and the output is filtered by C6. An ultrafast 1 A, 600 V with 75 ns reverse recovery time (t_{RR}) diode was selected for efficiency and good regulation over line and across temperature. The value of the output capacitor C6 was selected to give peak-to-peak LED ripple current equal to 30% of the mean value. For designs where lower ripple is required, the output capacitance value can be increased. The ripple is dependent on both output capacitance and the bulk resistance of the LED load; it recommended that the actual load be used when sizing the output capacitor in order to correctly achieve the specified ripple current.

A small output pre-load resistor R8 discharges the output capacitor when the driver is turned off, giving a quick and smooth decay of the LED light after turn-off. Recommended pre-load power dissipation is $\leq 0.25\%$ of the output power.

LYTSwitch-7 Device Size Selection

The data sheet power curve (Figure 6) represents the practical maximum continuous output power that can be delivered in an open frame design with adequate heat sinking.

DER-561 is a 7.5 W 60 V driver for a dimming bulb application. Using the power graph we can see that LYT7503D is the appropriate device to use.

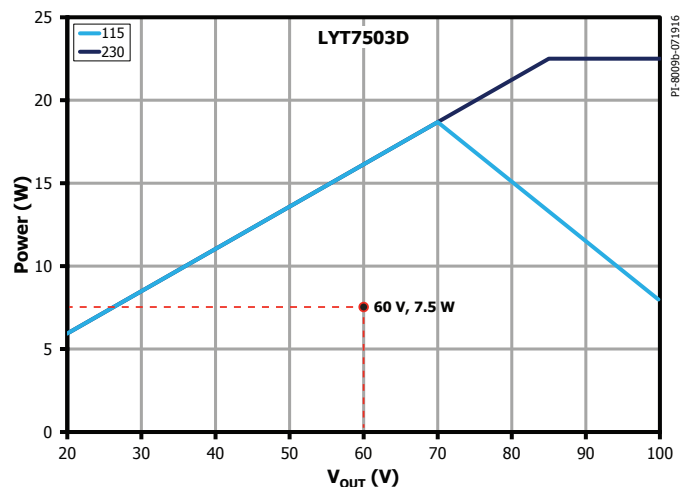

Figure 6. Output Power Graph.

Magnetic Selection

The small output inductor uses a ferrite cored EE10 with an open winding window that allows better convection cooling for the winding. An off-the-shelf “dog-bone” type inductor could also be used.

To ensure proper magnetic design and accurate output current regulation, it is recommended that the LYTSwitch-7 PIXIs spreadsheet located at PI Expert web site (<https://piexpertonline.power.com/site/login>) should be used for magnetics calculations.

EMI Considerations

Total input capacitance affects PF and THD – increasing the value will degrade performance, so these must be minimized. The LYTSwitch-7 control engine operates in CrM mode with variable frequency and variable on-time which provides low EMI enabling the use of only a small pi (π) filter. It also allows simple inductor construction suitable for the auto-winding inductor manufacturing approach used for low-cost high volume production. The recommended location of the

EMI filter is after the bridge rectifier as this allows the use of regular film capacitors (as opposed to more expensive safety rated X-capacitors that would be required if the filter is placed before the bridge).

Since the integrated switch MOSFET for LYTSwitch-7 is referenced to ground, the SOURCE pin acts as an EMI shield. This allows a “dog-bone” inductor to be used in low-side configurations as shown in DER-539 (Figure 7). The Design Engineering Reference (DER) report can be found at <https://led-driver.power.com/design-support/> on the PI website.

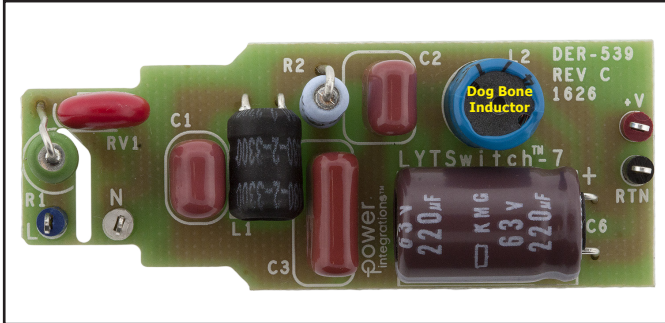

Figure 7. DER-539 Dimmable 6.24 W, 52 V, 120 mA Low-Line LED Driver using an Off-the-Shelf “Dog-Bone” Type Inductor.

Thermal and Lifetime Considerations

Lighting applications present significant thermal challenges to the driver. In many cases the LED load dissipation determines the working ambient temperature, so thermal evaluation should be performed with the driver inside the final enclosure. Temperature has a direct impact on driver and LED lifetime. For every 10 °C rise in temperature, component life is reduced by a factor of 2. Therefore, it is important to verify and minimize the operating temperature of each component.

PCB Layout Considerations

Shown in In Figure 8, the EMI filter components should be located close together to improve filter effectiveness. Place the EMI filter components C1 and L1 as far as possible from any switching nodes on the circuit board especially the U1 drain node, output diode (D1) and the inductor (T1).

Care should be taken in placing the critical IC components, namely R3, R4, R5, R9, R10, C5 and C4. It is strongly recommended that these components be placed very close to the pins of controller U1

to minimize long traces (which act as antennae), and as far away as possible from any high-voltage and/or high current switching nodes in the circuit to avoid potential noise coupling that may affect system operation.

For effective noise decoupling, the bypass supply capacitor C4 should be placed directly across BYPASS pin and SOURCE pin of U1.

Minimizing the loop areas of the following switching circuit elements (as shown in Figure 8) lessen the creation of EMI.

- Loop area formed by the inductor winding (T1), free-wheeling rectifier diode (D1) and output capacitor (C6).
- Loop area formed by input capacitor (C2), controller internal MOSFET (U1), free-wheeling rectifier diode (D1) and sense resistors (R4, R5).

With LYTSwitch-7 in a low-side configuration potential SOURCE pins are used for heat sinking are at ground potential. This allows the designer to maximize the copper area for good thermal management without increasing EMI.

Quick Design Checklist

Maximum Drain Voltage

Verify that the peak Drain voltage stress (VDS) does not exceed 725 V under any operating condition, including start-up and fault conditions.

Maximum Drain Current

Measure the peak drain current under all operation conditions (including start-up and fault conditions). Look for inductor saturation (usually occurs at highest operating ambient temperatures). Verify that the peak current is less than the stated Absolute Maximum Rating in the data sheet.

Thermal Check

At maximum output power, for both minimum and maximum line voltage and maximum ambient temperature verify that component temperature limits are not exceeded.

Design Tools

Up-to-date information on design tools can be found at the Power Integrations web site: www.power.com

LYTSwitch-7 PIXIs design spreadsheet can be accessed via PI Expert online: <https://pixipertonline.power.com/site/login>.

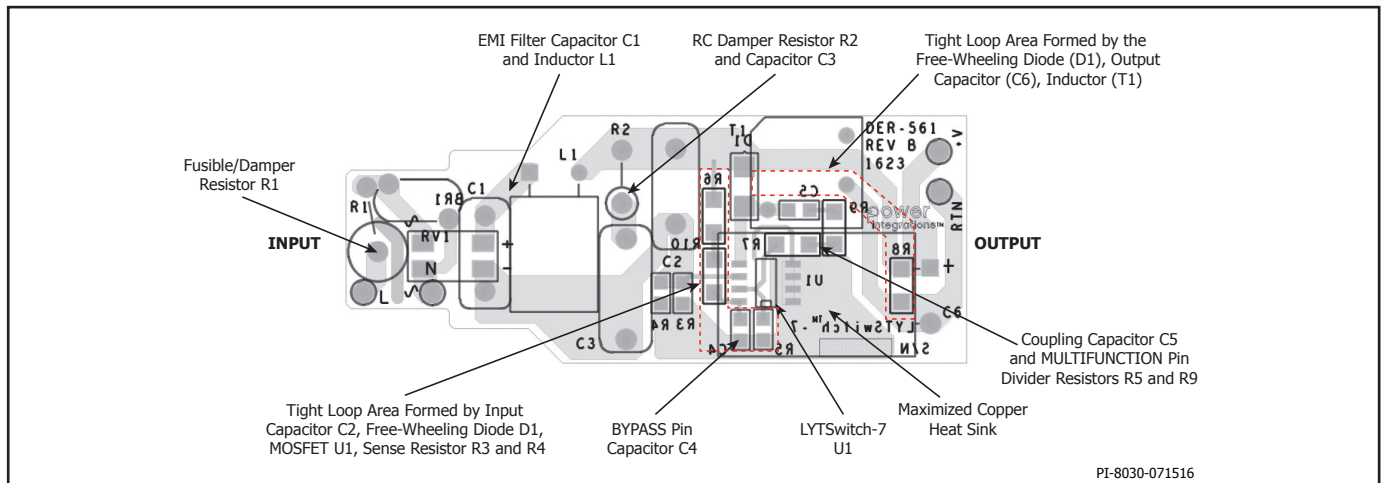

Figure 8. Design Example DER-561 PCB Layout Showing the Critical Loop Areas and Components with LYTSwitch-7 in Low-Side Buck Configuration.

Absolute Maximum Ratings^(1,3)

DRAIN Pin Voltage:	LYT750x	-0.3 V to 725 V
DRAIN Pin Peak Current:	LYT7503	1.05 A (1.3 A) ⁽¹⁾
	LYT7504	2.1 A (2.6 A) ⁽¹⁾
BYPASS Pin Voltage		-0.3 V to 6.0 V
MULTIFUNCTION, FEEDBACK Pin Voltage		-0.45 V to 7.0 V ⁽²⁾
Lead Temperature		260 °C
Storage Temperature		-65 to 150 °C
Operating Junction Temperature		-40 to 150 °C ⁽⁴⁾

Notes:

1. The higher peak Drain current (in parentheses) is allowed while the Drain-Source voltage is simultaneously less than 400 V for the integrated MOSFET.
2. If the SOURCE pin is open circuit, -0.7 V between FEEDBACK pin and SOURCE pin is observed with no degradation in performance.
3. The absolute maximum ratings specified may be applied one at a time without causing permanent damage to the product. Exposure to absolute maximum ratings for extended periods of time may affect product reliability.
4. Normally limited by internal circuitry.

Thermal Resistance

Thermal Resistance: SO-8 Package:

(θ_{JA})	100 °C/W ⁽²⁾ , 80 °C/W ⁽³⁾
(θ_{JC}) ⁽¹⁾	30 °C/W

Notes:

1. Measured on the SOURCE pin close to plastic interface.
2. Soldered to 0.36 sq. inch (232 mm²) 2 oz. (610 g/m²) copper clad pcb, with no external heat sink attached.
3. Soldered to 1 sq. in. (645 mm²), 2 oz. (610 g/m²) copper clad pcb.

Parameter	Symbol	Conditions		Min	Typ	Max	Units
		SOURCE = 0 V T _J = -40 °C to 125 °C (Unless Otherwise Specified)					
Control Functions							
Minimum Switching Frequency	f _{MIN}			18	20	22	kHz
Maximum Switch ON-Time	T _{ON(MAX)}				10		µs
Minimum Switch ON-Time	T _{ON(MIN)}			1.012	1.1	1.25	µs
FEEDBACK Pin Reference Voltage	V _{FB(REF)}		T _J = 25 °C See Note C	-285	-279	-273	mV
Dead Zone Detect Threshold	V _{TH(DZ)}				0.3 × V _{FB(REF)}		V
Maximum Constant Current Zone	T _{CC(MAX)}				6		ms
Forced Minimum Constant Current Zone	T _{CC(MIN)}				1.2		ms
BYPASS Pin Supply Current	I _{SBY}	Standby (MOSFET not switching)			180		µA
	I _{DSS}	MOSFET Switching	LYT7503		785		µA
	LYT7504			850			
BYPASS Pin Charge Current	I _{CH1}	V _{BP} = 0.0 V, V _{DS} ≥ 36 V		-10	-4.5		mA
	I _{CH2}	V _{BP} = 5.0 V, V _{DS} ≥ 36 V		-6	-2		mA
BYPASS Pin Voltage	V _{BP}			5.075	5.22	5.35	V
BYPASS Pin Shunt Voltage	V _{BP(SHUNT)}			5.2	5.39	5.55	V
BYPASS Pin Power-Up Reset Threshold Voltage	V _{BP(RESET)}			4.35	4.5	4.65	V

Parameter	Symbol	Conditions		Min	Typ	Max	Units
		SOURCE = 0 V T _J = -40 °C to 125 °C (Unless Otherwise Specified)					
Circuit Protection							
Current Limit for Auto-Restart	I _{LIMIT(AR)}	di/dt = 446 mA/μs T _J = 25 °C	LYT7503	1.06	1.15	1.24	A
		di/dt = 662 mA/μs T _J = 25 °C	LYT7504	1.61	1.75	1.88	
Fault Minimum Switch ON-Time	T _{FAULT(MIN)}				250	400	ns
Auto-Restart	T _{AR(OFF)1}	T _J = 25 °C			100		ms
	T _{AR(OFF)2}				1000		
Input Overvoltage Threshold	I _{IOV}	T _J = 25 °C		0.9	1.0	1.1	mA
MULTIFUNCTIONAL Pin Auto-Restart Threshold Voltage (Output OVP)	V _{OOV}	T _J = 25 °C		2.3	2.4	2.48	V
MULTIFUNCTIONAL Pin Undervoltage Threshold (Output Short)	V _{OUV}	T _J = 25 °C See Note B		0.91	0.95	0.99	V
Junction Temperature at Fold-Back	T _{FB}	See Note B		138	145	152	°C
Thermal Shutdown Temperature	T _{SD}	See Note A			160		°C
Thermal Shutdown Hysteresis	T _{SD(H)}	See Note A			75		°C
Output							
ON-State Resistance	R _{DS(ON)}	LYT7503 I _D = 139 mA	T _J = 25 °C		4.5	5.2	Ω
			T _J = 100 °C		6.8	7.8	
		LYT7504 I _D = 182 mA	T _J = 25 °C		3.4	3.9	
			T _J = 100 °C		5.1	5.8	
OFF-State Leakage	I _{DSS1}	V _{BP} = 5.25 V, V _{DS} = 580 V T _J = 125 °C	LYT7503			55	μA
			LYT7504			70	
Breakdown Voltage	BV _{DSS}	LYT750x		725			V

NOTES:

- Guaranteed by design.
- This parameter is derived from characterization. Not production tested.
- All parts are individually trimmed in production to deliver the best CC accuracy.

Typical Performance Characteristics

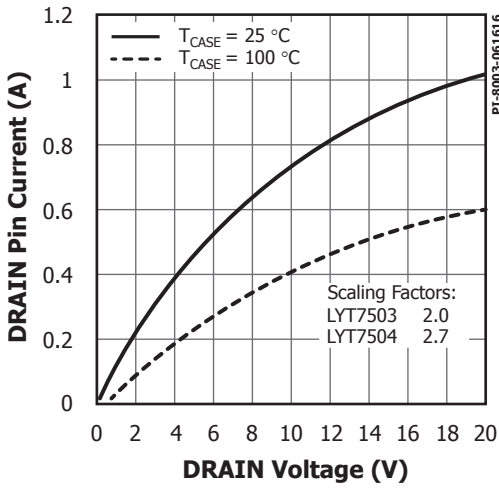

Figure 9. DRAIN Pin Current vs. Drain Pin Voltage.

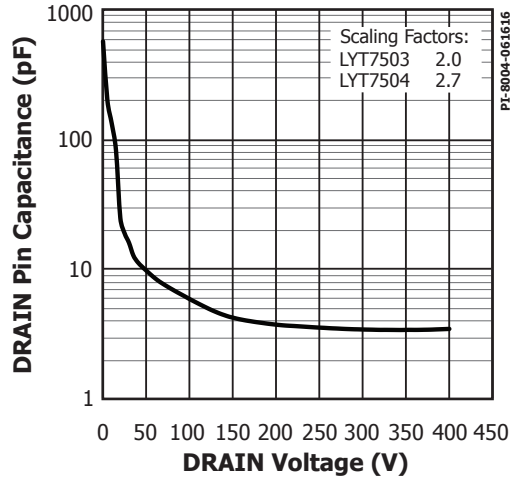

Figure 10. DRAIN Pin Capacitance vs. DRAIN Pin Voltage.

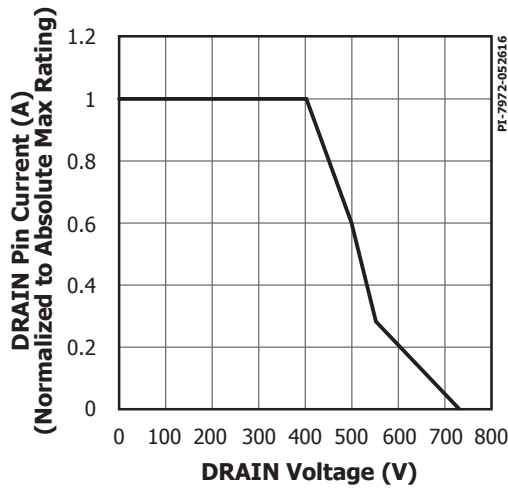
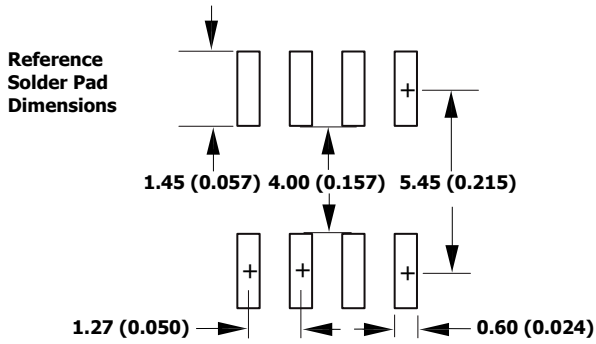
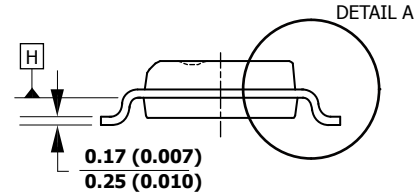
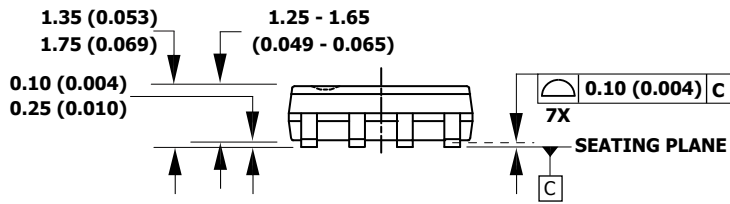
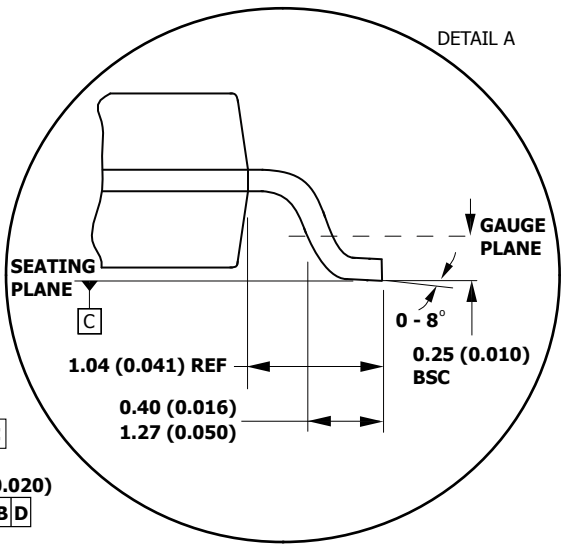
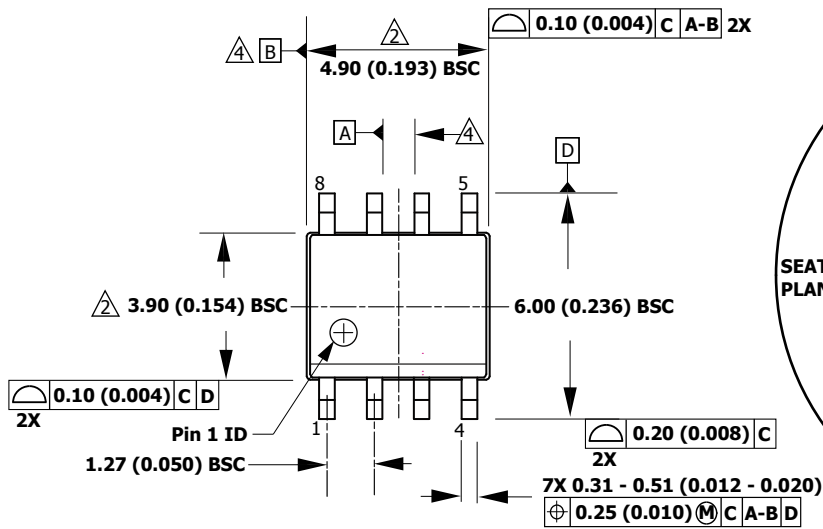

Figure 11. Maximum Allowable DRAIN Pin Current vs. DRAIN Pin Voltage.

SO-8 (D Package)



- Notes:**
1. JEDEC reference: MS-012.
 2. Package outline exclusive of mold flash and metal burr.
 3. Package outline inclusive of plating thickness.
 4. Datums A and B to be determined at datum plane H.
 5. Controlling dimensions are in millimeters. Inch dimensions are shown in parenthesis. Angles in degrees.

D08A

PI-5615-020515

MSL Table

Part Number	MSL Rating
LYT7503D	1
LYT7504D	1

ESD and Latch-Up Table

Test	Conditions	Results
Latch-up at 125 °C	JESD78D	> ±100 mA or > 1.5 × V(max) on all pins
Human Body Model ESD	ANSI/ESDA/JEDEC JS-001-2012	> ±2000 V on all pins
Machine Model ESD	JESD22-A115CA	> ±200 V on all pins
Charged Device Model ESD	JESD22-C101	> ±500 V on all pins

Part Ordering Information

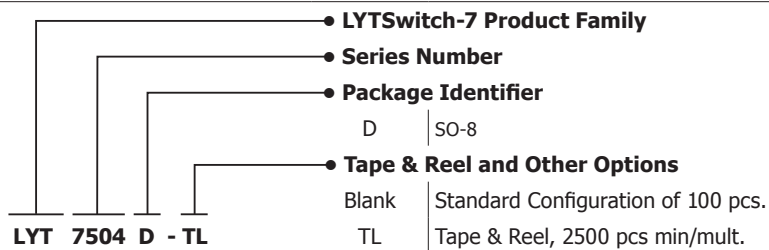

Notes

Revision	Notes	Date
A	Code S.	07/16
B	Code A.	07/16
C	Added Application Example section.	07/16

For the latest updates, visit our website: www.power.com

Power Integrations reserves the right to make changes to its products at any time to improve reliability or manufacturability. Power Integrations does not assume any liability arising from the use of any device or circuit described herein. POWER INTEGRATIONS MAKES NO WARRANTY HEREIN AND SPECIFICALLY DISCLAIMS ALL WARRANTIES INCLUDING, WITHOUT LIMITATION, THE IMPLIED WARRANTIES OF MERCHANTABILITY, FITNESS FOR A PARTICULAR PURPOSE, AND NON-INFRINGEMENT OF THIRD PARTY RIGHTS.

Patent Information

The products and applications illustrated herein (including transformer construction and circuits external to the products) may be covered by one or more U.S. and foreign patents, or potentially by pending U.S. and foreign patent applications assigned to Power Integrations. A complete list of Power Integrations patents may be found at www.power.com. Power Integrations grants its customers a license under certain patent rights as set forth at <http://www.power.com/ip.htm>.

Life Support Policy

POWER INTEGRATIONS PRODUCTS ARE NOT AUTHORIZED FOR USE AS CRITICAL COMPONENTS IN LIFE SUPPORT DEVICES OR SYSTEMS WITHOUT THE EXPRESS WRITTEN APPROVAL OF THE PRESIDENT OF POWER INTEGRATIONS. As used herein:

1. A Life support device or system is one which, (i) is intended for surgical implant into the body, or (ii) supports or sustains life, and (iii) whose failure to perform, when properly used in accordance with instructions for use, can be reasonably expected to result in significant injury or death to the user.
2. A critical component is any component of a life support device or system whose failure to perform can be reasonably expected to cause the failure of the life support device or system, or to affect its safety or effectiveness.

The PI logo, TOPSwitch, TinySwitch, SENZero, SCALE-iDriver, Qspeed, PeakSwitch, LYTSwitch, LinkZero, LinkSwitch, InnoSwitch, HiperTFS, HiperPFS, HiperLCS, DPA-Switch, CAPZero, Clampless, EcoSmart, E-Shield, Filterfuse, FluxLink, StakFET, PI Expert and PI FACTS are trademarks of Power Integrations, Inc. Other trademarks are property of their respective companies. ©2016, Power Integrations, Inc.

Power Integrations Worldwide Sales Support Locations

World Headquarters

5245 Hellyer Avenue
San Jose, CA 95138, USA.
Main: +1-408-414-9200
Customer Service:
Phone: +1-408-414-9665
Fax: +1-408-414-9765
e-mail: usasales@power.com

China (Shanghai)

Rm 2410, Charity Plaza, No. 88
North Caoxi Road
Shanghai, PRC 200030
Phone: +86-21-6354-6323
Fax: +86-21-6354-6325
e-mail: chinasales@power.com

China (Shenzhen)

17/F, Hivac Building, No. 2, Keji Nan
8th Road, Nanshan District,
Shenzhen, China, 518057
Phone: +86-755-8672-8689
Fax: +86-755-8672-8690
e-mail: chinasales@power.com

Germany

Lindwurmstrasse 114
80337 Munich
Germany
Phone: +49-895-527-39110
Fax: +49-895-527-39200
e-mail: eurosales@power.com

Germany

HellwegForum 1
59469 Ense
Germany
Tel: +49-2938-64-39990
e-mail: igbt-driver.sales@power.com

India

#1, 14th Main Road
Vasanthanagar
Bangalore-560052 India
Phone: +91-80-4113-8020
Fax: +91-80-4113-8023
e-mail: indiasales@power.com

Italy

Via Milanese 20, 3rd. Fl.
20099 Sesto San Giovanni (MI) Italy
Phone: +39-024-550-8701
Fax: +39-028-928-6009
e-mail: eurosales@power.com

Japan

Kosei Dai-3 Bldg.
2-12-11, Shin-Yokohama,
Kohoku-ku
Yokohama-shi, Kanagawa
222-0033 Japan
Phone: +81-45-471-1021
Fax: +81-45-471-3717
e-mail: japansales@power.com

Korea

RM 602, 6FL
Korea City Air Terminal B/D, 159-6
Samsung-Dong, Kangnam-Gu,
Seoul, 135-728, Korea
Phone: +82-2-2016-6610
Fax: +82-2-2016-6630
e-mail: koreasales@power.com

Singapore

51 Newton Road
#19-01/05 Goldhill Plaza
Singapore, 308900
Phone: +65-6358-2160
Fax: +65-6358-2015
e-mail: singaporesales@power.com

Taiwan

5F, No. 318, Nei Hu Rd., Sec. 1
Nei Hu Dist.
Taipei 11493, Taiwan R.O.C.
Phone: +886-2-2659-4570
Fax: +886-2-2659-4550
e-mail: taiwansales@power.com

UK

Cambridge Semiconductor,
a Power Integrations company
Westbrook Centre, Block 5, 2nd Floor
Milton Road
Cambridge CB4 1YG
Phone: +44 (0) 1223-446483
e-mail: eurosales@power.com