

Boost Type LED Driver with 12-Channel Current Source
AP3612

General Description

The AP3612 is a high efficiency boost controller with 12-string current sources for driving WLED backlight. It operates over a wide input voltage range from 4.5V to 33V.

The current of 12 strings are simply programmed from 20mA to 75mA with an external resistor. The current matching between each string is 1.5% (Typ). Its operating frequency can be adjusted from 0.1MHz to 1MHz.

The AP3612 features Cycle-by-cycle Current Limit, Soft Start, Under Voltage Lock Out (UVLO) protection, programmable OVP, Over Temperature Protection (OTP), open/short LED protection, V_{OUT} short protection and Schottky diode short-circuit protection.

The AP3612 is available in HSOP-28 and SOIC-24 packages.

Features

- Input Voltage Range: 4.5V to 33V
- Drives up to 12 Strings in Parallel, 75mA per String
- Programmable WLED Current from 20mA to 75mA
- Adjustable Operating Frequency: 100kHz to 1MHz
- String-to-string Current Matching Accuracy: 1.5%
- Built-in OCP, OTP, UVLO
- External PWM Dimming
- Open/Short LED Protection
- Programmable Soft Start
- Programmable OVP
- Schottky Diode/Inductor Short-circuit Protection
- V_{OUT} Short/Schottky Diode Open Protection

Applications

- LCD Monitor
- LCD Display Module
- LCD TV

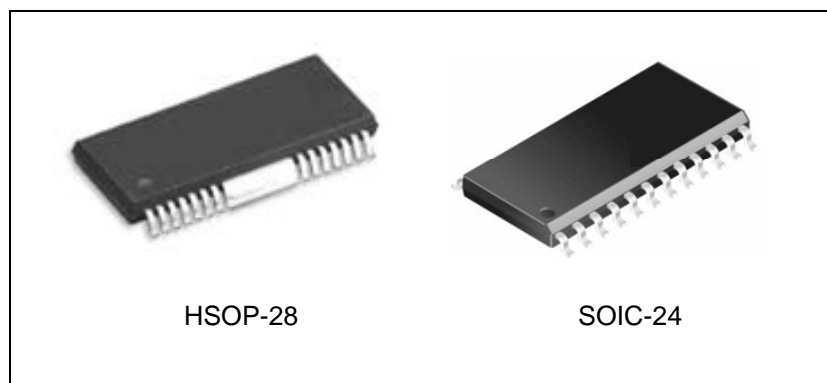

Figure 1. Package Types of AP3612

Pin Configuration

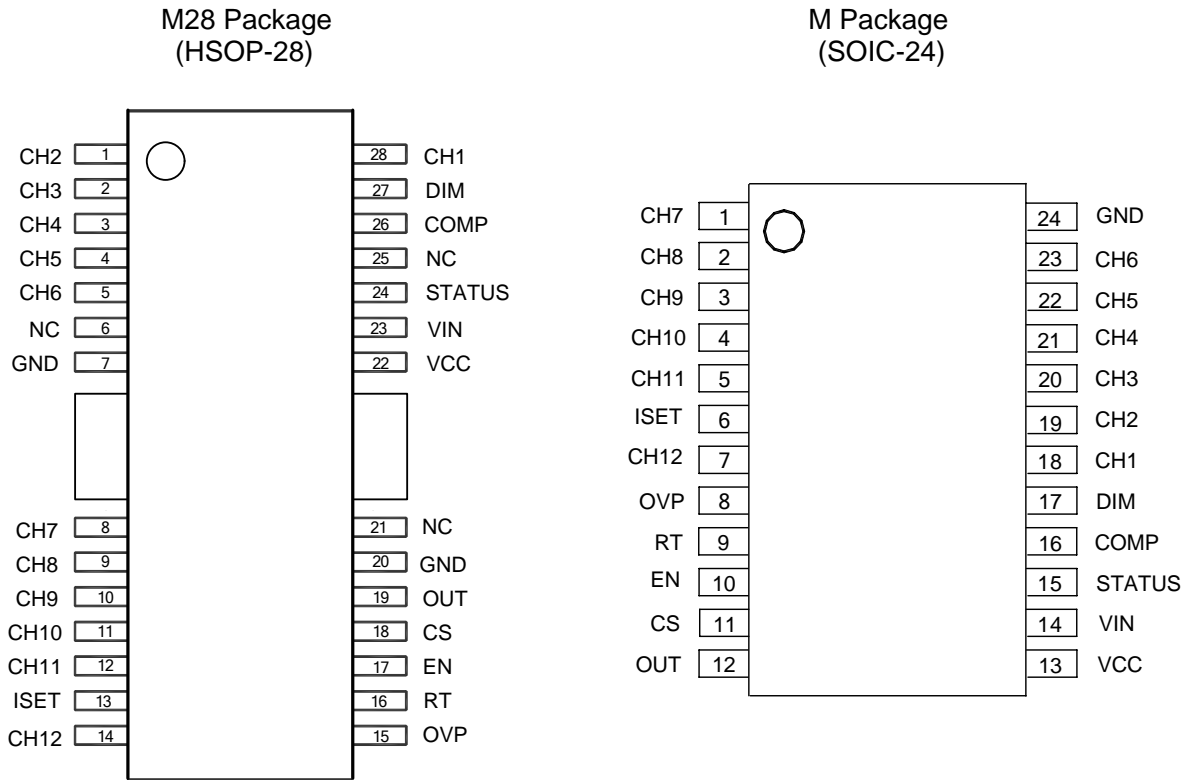

Figure 2. Pin Configuration of AP3612 (Top View)

**Boost Type LED Driver with 12-Channel Current Source****AP3612****Pin Description**

Pin Number		Pin Name	Function
HSOP-28	SOIC-24		
28,1,2,3,4,5, 8,9,10,11,12,14	18,19,20,21, 22,23, 1, 2, 3, 4, 5, 7	CH1 to CH12	LED current sink. Leave the pin open directly if not used
6, 21,25		NC	No connection
7, 20	24	GND	Ground pin
13	6	ISET	LED current setting pin. The corresponding maximum current of all strings is set through connecting a resistor from this pin to GND
15	8	OVP	Over voltage protection pin. When the OVP pin voltage exceeds 2.0V, the OVP is triggered and the power switch is turned off. When the OVP pin voltage drops below hysteresis voltage, the OVP is released and the power switch will resume normal operation
16	9	RT	Frequency control pin
17	10	EN	ON/OFF control pin. Forcing this pin above 2.4V enables the IC while below 0.5V shuts down the IC. When the IC is in shutdown mode, all functions are disabled to decrease the supply current below 3 μ A
18	11	CS	Power switch current sense input
19	12	OUT	Boost converter power switch gate output. This pin output high voltage ($5V/V_{IN}-0.5V$) to drive the external N-MOSFET
22	13	VCC	5V linear regulator output pin. This pin should be bypassed to GND (recommend to connect with GND pin) with a ceramic capacitor
23	14	VIN	Supply input pin. A capacitor (typical 10 μ F) should be connected between the VIN and GND to keep the DC input voltage constant
24	15	STATUS	LED operation status output
26	16	COMP	Soft-start and control loop compensation
27	17	DIM	PWM dimming control pin. Adding a PWM signal to this pin to control LED dimming. If not used, connect it to the high level

Functional Block Diagram

Figure 3. Functional Block Diagram of AP3612

**Boost Type LED Driver with 12-Channel Current Source****AP3612****Ordering Information**

Package	Temperature Range	Part Number	Marking ID	Packing Type
HSOP-28	-40 to 85°C	AP3612M28-G1	AP3612M28-G1	Tube
SOIC-24		AP3612M-G1	AP3612M-G1	Tube

BCD Semiconductor's Pb-free products, as designated with "G1" suffix in the part number, are RoHS compliant and green.

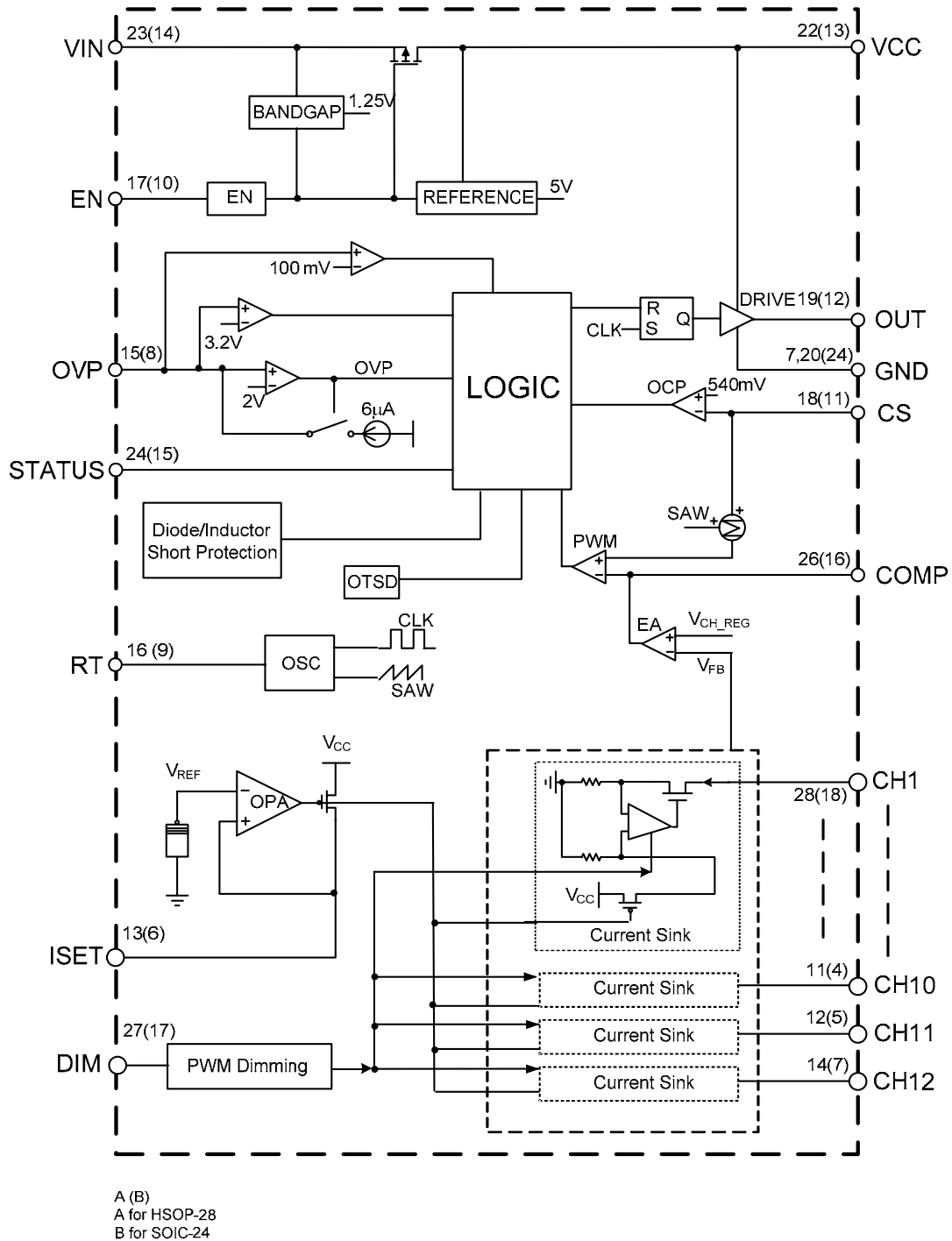
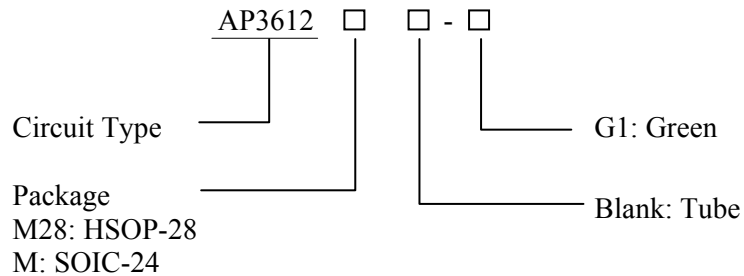
Absolute Maximum Ratings (Note 1)

Parameter	Symbol	Value	Unit
Input Voltage	V_{IN}	-0.3 to 42	V
CH1 to CH12 Voltage	V_{CH}	-0.3 to 65	V
EN Pin Voltage	V_{EN}	-0.3 to 7	V
VCC Pin Voltage	V_{CC}	-0.3 to 7	V
CS Pin Voltage	V_{CS}	-0.3 to 7	V
COMP Pin Voltage	V_{COMP}	-0.3 to 7	V
ISET Pin Voltage	V_{ISET}	-0.3 to 7	V
OUT Pin Voltage	V_{OUT}	-0.3 to 7	V
OVP Pin Voltage	V_{OVP}	-0.3 to 7	V
RT Pin Voltage	V_{RT}	-0.3 to 7	V
STATUS Pin Voltage	V_{STATUS}	-0.3 to 7	V
DIM Pin Voltage	V_{DIM}	-0.3 to 7	V
GND Pin Voltage	V_{GND}	-0.3 to 0.3	V
Thermal Resistance (Junction to Ambient, Free Air, No Heatsink)	HSOP-28	θ_{JA}	°C/W
	SOIC-24		
			100

**Boost Type LED Driver with 12-Channel Current Source****AP3612****Absolute Maximum Ratings (Note 1) (Continued)**

Parameter	Symbol	Value	Unit
Operating Junction Temperature	T_J	150	°C
Storage Temperature	T_{STG}	-65 to 150	°C
Lead Temperature (Soldering, 10sec)	T_{LEAD}	260	°C
ESD (Machine Model)		200	V
ESD (Human Body Model)		2000	V

Note 1: Stresses greater than those listed under “Absolute Maximum Ratings” may cause permanent damage to the device. These are stress ratings only, and functional operation of the device at these or any other conditions beyond those indicated under “Recommended Operating Conditions” is not implied. Exposure to “Absolute Maximum Ratings” for extended periods may affect device reliability.

Note 2: Negative CS 100ns Transient maximum rating voltage reach to -0.4V.

Recommended Operating Conditions

Parameter	Symbol	Min	Max	Unit
Input Voltage	V_{IN}	4.5	33	V
Operating Frequency	f_O	0.1	1	MHz
LED Channel Voltage	V_{CHX}		60	V
LED Channel Current	I_{CHX}	20	75	mA
PWM Dimming Frequency	f_{PWM}	0.1	20	kHz
Operating Ambient Temperature Range	T_A	-40	85	°C



Boost Type LED Driver with 12-Channel Current Source

AP3612

Electrical Characteristics

$V_{IN}=24V$, $V_{EN}=5V$, Typical $T_A=25^{\circ}C$, unless otherwise specified.

Parameter	Symbol	Conditions	Min	Typ	Max	Unit
INPUT SUPPLY						
Input Voltage	V_{IN}		4.5		33	V
Quiescent Current	I_Q	No Switching		3	5	mA
Shutdown Supply Current	I_{SHTD}	$V_{EN}=V_{DD}=0V$		0.1	3	μA
UVLO	V_{UVLO}	V_{IN} Rising	3.6	3.8	4.0	V
UVLO Hysteresis	V_{HYS}			200		mV
VCC SECTION						
VCC Voltage	V_{CC}	$V_{IN} \geq 5.5V$		5		V
		$V_{IN} < 5.5V$, Load=10mA		$V_{IN}-0.1$		V
OUT Pin Rising Time (Note 3)	t_{RISING}	1nF Load		30	50	ns
OUT Pin Falling Time (Note 3)	$t_{FALLING}$	1nF Load		30	50	ns
Load Regulation (Note 3)		Load=0 to 30mA		5		mV/mA
Line Regulation (Note 3)		$V_{IN}=5.5$ to 24V		0.3		mV/V
HIGH FREQUENCY OSCILLATOR						
Switch Frequency (Target: 10% Variation)	f_{OSC}	$R_T=100k\Omega$	440	520	600	kHz
Switch Frequency Range			0.1		1	MHz
Maximum Duty Cycle	D_{MAX}	$f=500kHz$	88	90		%
Minimum On-time (Note 3)	$t_{ON-TIME}$	$f=500kHz$		200		ns
ENABLE LOGIC AND DIMMING LOGIC						
EN High Voltage	V_{EN_H}		2.4			V
EN Low Voltage	V_{EN_L}				0.5	V
PWM Logic for External Dimming	V_{DIM_H}		2.5			V
	V_{DIM_L}				0.3	V
PWM Dimming Minimum Pulse Width (Note 3)	t_{PWM_MIN}			$3/f_{osc}$		μs

**Boost Type LED Driver with 12-Channel Current Source****AP3612****Electrical Characteristics (Continued)** $V_{IN}=24V$, $V_{EN}=5V$, Typical $T_A=25^\circ C$, unless otherwise specified.

Parameter	Symbol	Conditions	Min	Typ	Max	Unit
POWER SWITCH DRIVE						
Current Limit Threshold Voltage	V_{LIMIT}		480	540	600	mV
D/L Short Threshold Voltage (Note 3)	V_{LIMIT2}		720	800	880	mV
Current Sense LEB Time (Note 3)	t_{LEB}		80	100	150	ns
COMPENSATION AND SOFT START (COMP PIN)						
Error Amplifier Trans-conductance	G_{EA}			2300		$\mu A/V$
Sourcing Current	I_{O_H}	$V_{COMP}=0.5V$	80	120	160	μA
Sinking Current	I_{O_L}	$V_{COMP}=2V$	80	120	160	μA
OVER VOLTAGE PROTECTION						
OVP Threshold Voltage	V_{OVP}	V_{OUT} Rising	1.9	2.0	2.1	V
OVP Hysteresis	V_{OVP_HYS}			250		mV
Shutdown Under Abnormal Condition	V_{OVP-SH}		3.0	3.2	3.4	V
CURRENT SOURCE						
LED Current Matching between Each String (Note 4)	I_{CH_MATCH}	$I_{CH}=60mA$		1.5	4	%
Regulation Current per Channel	I_{CH}	$R_{ISET}=6.667k\Omega$	55	60	65	mA
Minimum LED Regulation Voltage	V_{LED_REG}	$I_{CHX}=60mA$		400		mV
CH1 to CH12 Leakage Current	I_{LED_LEAK}	$V_{EN}=0V$, $V_{LED}=37V$		0.1	1	μA
LED Short Protection Threshold	V_{LED-S}		6.6	7.3	8.0	V
OVER TEMPERATURE PROTECTION						
Thermal Shutdown Temperature (Note 3)	T_{OTSD}			160		$^\circ C$
Thermal Shutdown Recovery (Note 3)	T_{HYS}			140		$^\circ C$

Note 3: Guaranteed by design.

$$\text{Note 4: } I_{ST_MATCH} = \frac{I_{MAX} - I_{MIN}}{2 \times I_{AVG}} \times 100\%$$



Boost Type LED Driver with 12-Channel Current Source

AP3612

Typical Performance Characteristics

$V_{IN}=24V$, $V_{EN}=V_{DD}=5V$, 13 LEDs in series, 12 strings in parallel, 60mA/string, $T_A=25^\circ C$, unless otherwise specified.

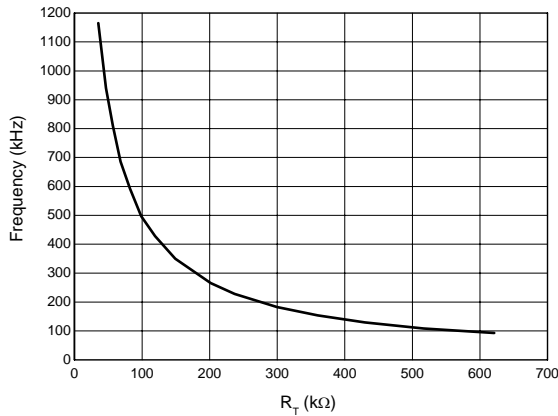

Figure 4. Frequency vs. R_T

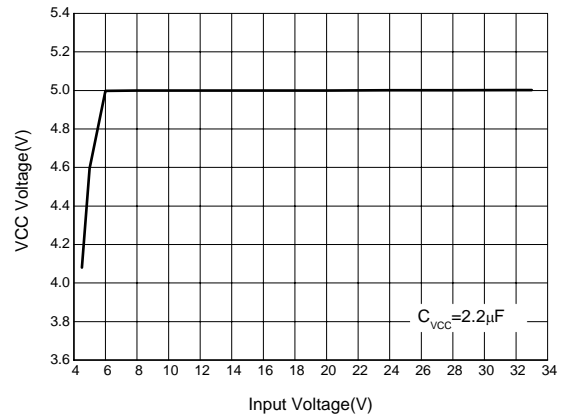

Figure 5. VCC Voltage vs. Input Voltage

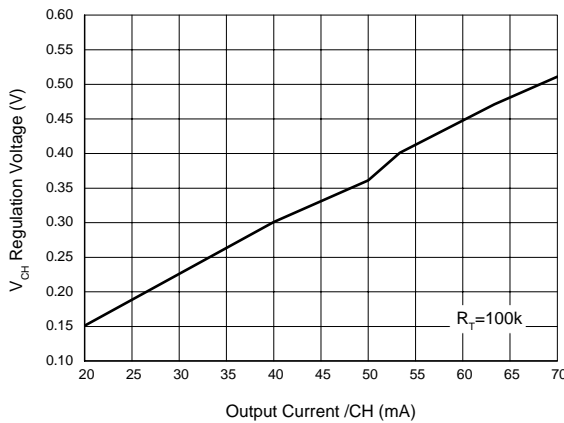

Figure 6. V_{CH} Regulation Voltage vs. Output Current

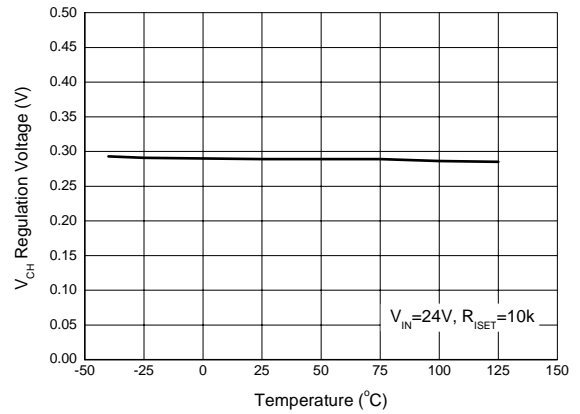

Figure 7. V_{LED} Regulation Voltage vs. Temperature

Typical Performance Characteristics (Continued)

$V_{IN}=24V$, $V_{EN}=V_{DD}=5V$, 13 LEDs in series, 12 strings in parallel, 60mA/string, $T_A=25^\circ C$, unless otherwise specified.

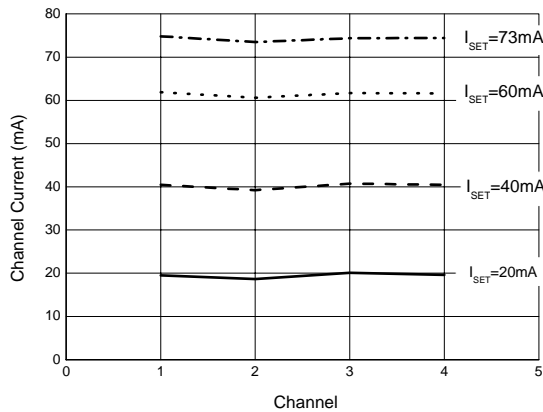

Figure 8. Channel Current vs. Channel

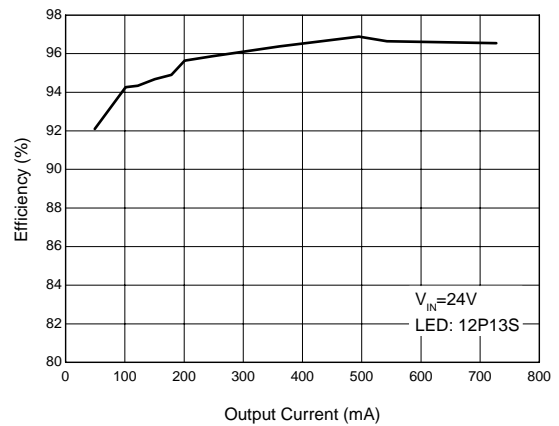
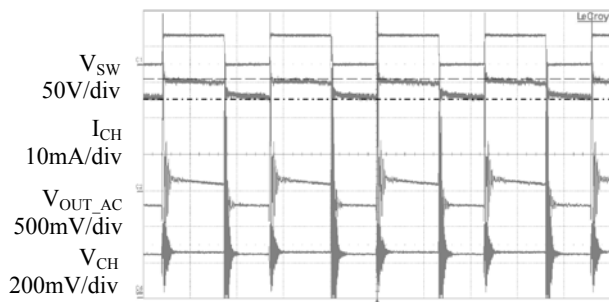
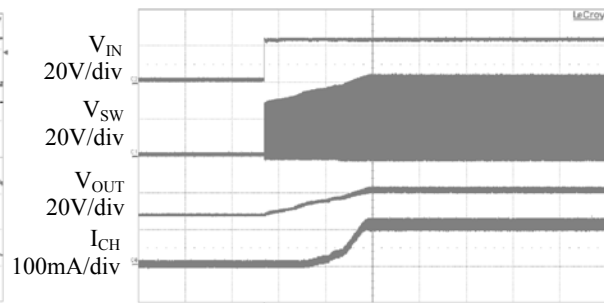

Figure 9. Efficiency vs. Output Current



Time 1µs/div

Figure 10. Steady State



Time 20ms/div

Figure 11. System Startup

Typical Performance Characteristics (Continued)

$V_{IN}=24V$, $V_{EN}=V_{DD}=5V$, 13 LEDs in series, 12 strings in parallel, 60mA/string, $T_A=25^\circ C$, unless otherwise specified.

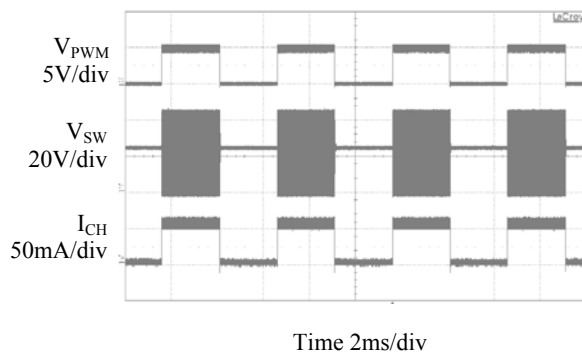

Figure 12. PWM Dimming

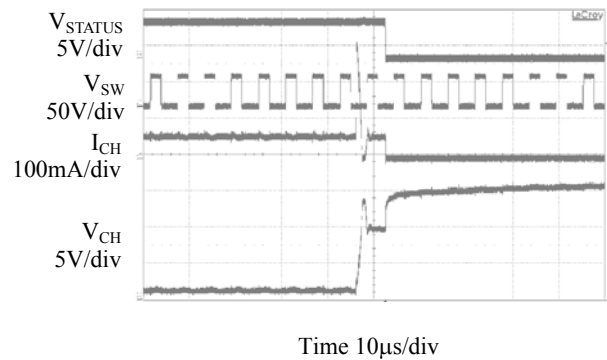

Figure 13. LED Short Protection

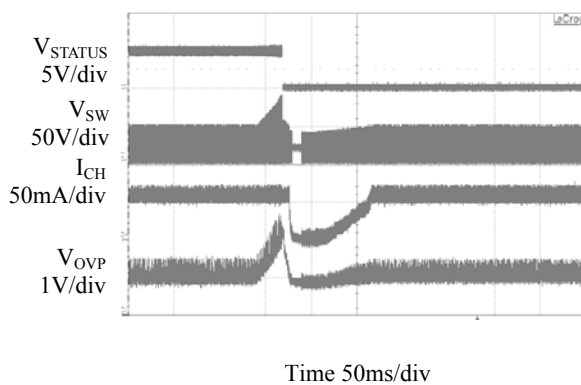

Figure 14. LED Open Protection

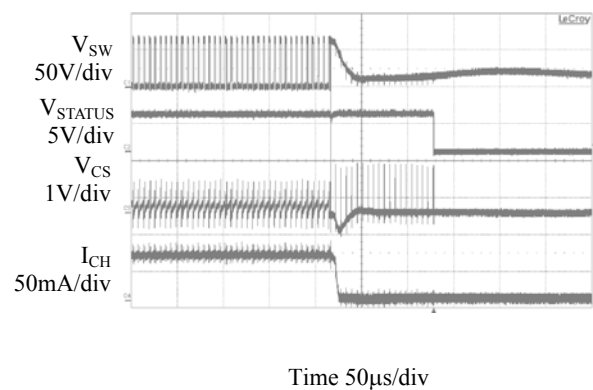

Figure 15. Schottky/Inductor Short Protection

Typical Performance Characteristics (Continued)

$V_{IN}=24V$, $V_{EN}=V_{DD}=5V$, 13 LEDs in series, 12 strings in parallel, 60mA/string, $T_A=25^\circ C$, unless otherwise specified.

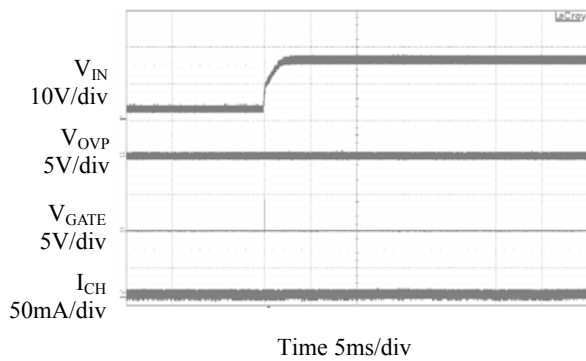
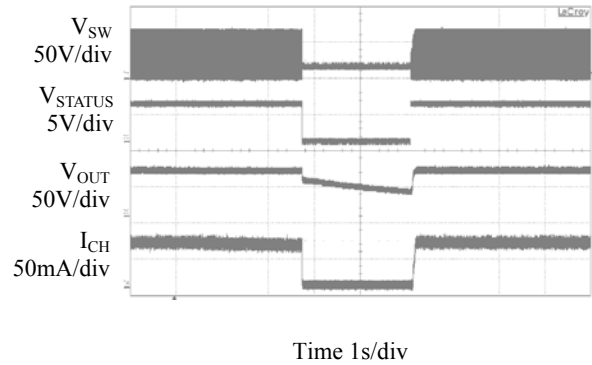

 Figure 16. V_{OUT} Short/Diode Open Protection

Figure 17. Over Temperature Protection



Application Information

1. Enable

The AP3612 is enabled when the voltage to EN is greater than approximately 2.4V, disabled when lower than 0.5V.

2. Frequency Selection

An external resistor R_T , placed between RT pin and GND, can be used to set the operating frequency. The operating frequency ranges from 100kHz to 1MHz. The high frequency operation optimizes the regulator for the smallest-sized component application, while low frequency operation can help to reduce switch loss. The approximate operating frequency can be expressed as below:

$$f_{osc} [MHz] = \frac{52}{R_{RT} [K\Omega]}$$

3. LED Current Setting

The maximum LED current per channel can be adjusted up to 75mA via ISET pin. When $\geq 75mA$ current is needed in application, two or more channels can be paralleled to provide larger drive current. Connect a resistor R_{ISET} between ISET pin and GND to set the reference current I_{SET} . The LED current can be expressed as below:

$$I_{LED} [mA] = \frac{400}{R_{ISET} [K\Omega]}$$

4. Dimming Control

Applying a PWM signal to DIM pin to adjust the LED current, that means, the LED current of all enabled channels can be adjusted at the same time and the LED brightness can be adjusted from $1\% \times I_{CHX_MAX}$ to $100\% \times I_{CHX_MAX}$. During the “high level” period of PWM signal, the LED is turned on and 100% of the current flows through LED, while during the “low level” period of the PWM signal, the LED is turned off and almost no current flows through the LED, thus changing the average current through LED and finally adjusting LED brightness. The external PWM signal frequency applied to PWM pin is allowed to be 100Hz or higher.

5. Status Output

After IC is enabled, STATUS will output logic low if any of the following conditions exists:

- 1) Any String is Open
- 2) LED Short Circuit Protection
- 3) Shut Down Under Abnormal Condition
- 4) Over Temperature Protection
- 5) Schottky Diode Short Protection
- 6) Over Voltage Protection
- 7) V_{OUT} Short/Open Schottky Diode Protection

6. Over Voltage Protection

The AP3612 integrates an OVP circuit. The OVP pin is connected to the center tap of voltage-divider (R_{OV1} and R_{OV2}) that placed between high voltage output and GND. If the voltage on OVP pin exceeds 2.0V, which may results from open loop or excessive output voltage, all the functions of AP3612 will be disabled with output voltage falling. The OVP hysteresis is 250mV. The formula of OVP can be expressed as below:

$$V_{OVP} = \frac{(R_{OV1} + R_{OV2}) \times 2.0V}{R_{OV2}}$$

7. Over Current Protection

The AP3612 integrates an OCP circuit. The CS pin is connected to the voltage-sensor (R_{CS}) that placed between the Drain of MOS and GND. If the voltage on CS pin exceeds 0.54V, it is turned off immediately and will not turn on until the next cycle begins.

8. LED Short-circuit Protection

The AP3612 integrates an LED Short-circuit protection circuit. If the voltage at any of the CH1-CH12 pins exceeds a threshold of approximately 7.3V during normal operation, the corresponding string is turned off and is latched off. Toggle V_{IN} and/or EN to reset the latch. LED short detecting logic priority is lower than open LED and OVP logic. The LED short detecting is triggered when $0.1V < V_{LED_MIN}$ under dimming on mode, disabled when LED open occurs until output voltage resumes to the regulated voltage.



Application Information (Continued)

9. LED Open-circuit Protection

The AP3612 integrates an LED Open-circuit Protection circuit. When any LED string is open, V_{OUT} will boost up until the voltage at OVP pin reaches an approximate 2.0V threshold. The IC will automatically ignore the open string whose corresponding pin voltage is less than 100mV and the remaining string will continue operation. If all the strings are open and the voltage at OVP reaches a threshold of 2.0V, the MOSFET drive GATE will turn off and IC will shut down and latch.

10. V_{OUT} Short/Open Schottky Diode Protection

The AP3612 monitors the OVP pin, if the OVP pin voltage is less than 0.1V, MOSFET drive output will turn off. This protects the converter if the output Schottky diode is open or V_{OUT} is shorted to ground.

11. Under Voltage Lockout

The AP3612 provides an under voltage lockout circuit to prevent it from undefined status when startup. The UVLO circuit shuts down the device when V_{CC} drops below 3.6V. The UVLO circuit has 200mV hysteresis, which means the device starts up again when V_{CC} rise to 3.8V.

12. Over Temperature Protection

The AP3612 features Over Temperature Protection, if the junction temperature exceeds approximately 160°C, the IC will shut down until the junction temperature is less than approximately 140°C. When the IC is released from over temperature shutdown, it will start a soft-start process.

13. Schottky Diode/Inductor Short Circuit Protection

The AP3612 features Schottky diode/inductor short-circuit protection circuit. When CS pin voltage exceeds 0.8V for greater than 16 switching clocks, the IC will be latched. The voltage of CS is monitored after a short delay of LEB.

14. Shut Down under Abnormal Condition

The AP3612 features shutdown under abnormal condition protection circuit. When OVP pin voltage exceeds 3.2V, the IC will latch. Toggle EN to restart the IC. This feature can be used for any other protection to shut down the IC.

Typical Application

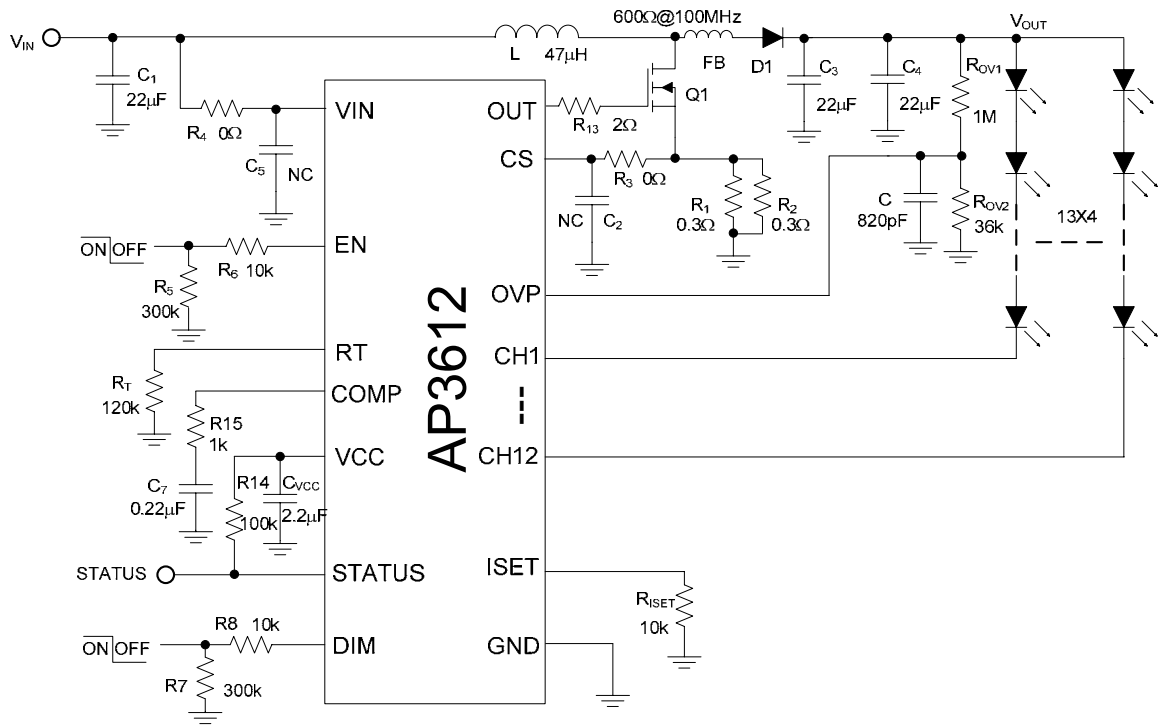
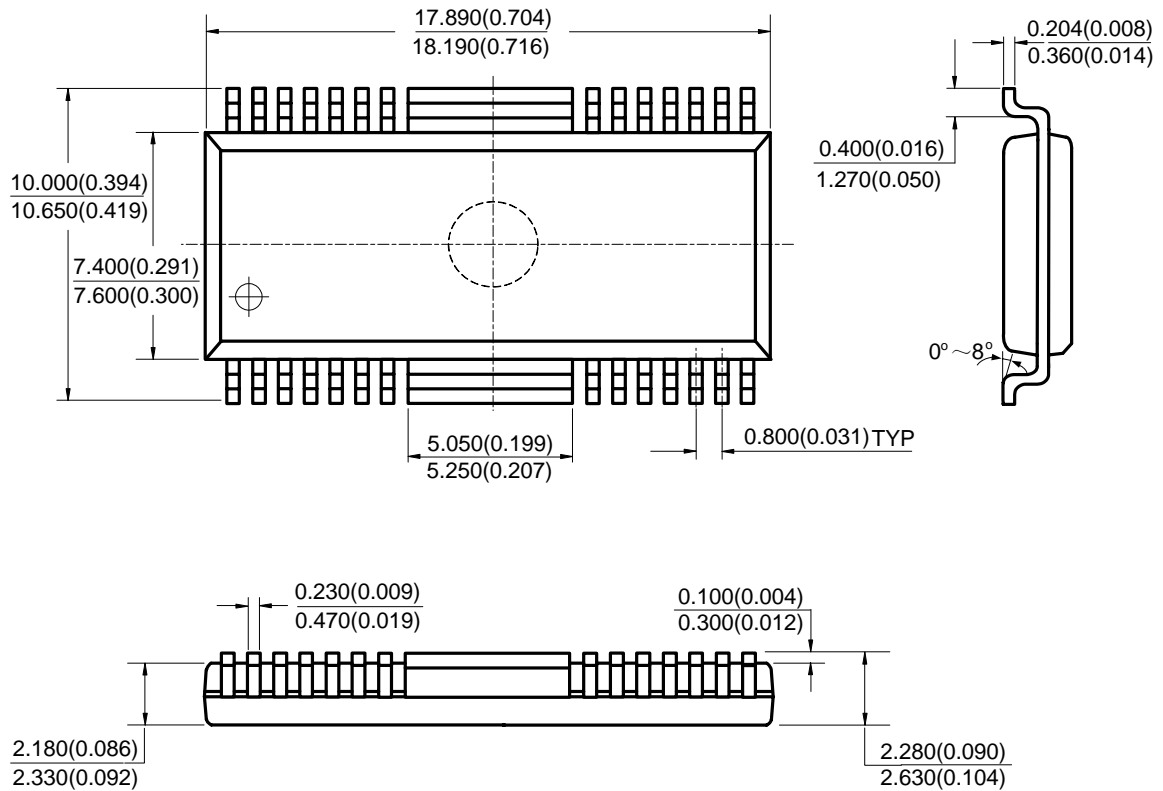
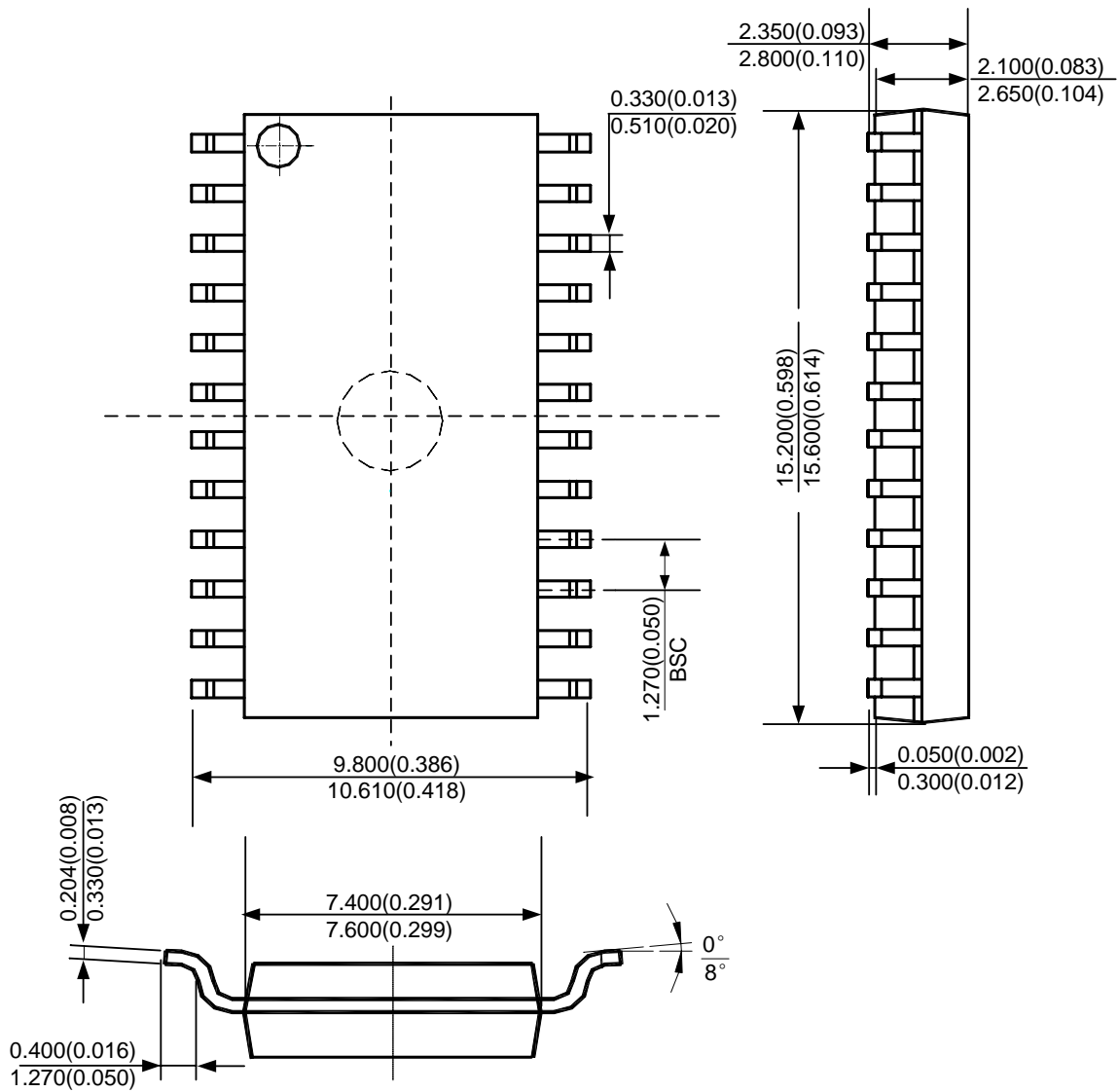

Figure 18. Typical Application Circuit of AP3612

Mechanical Dimensions
HSOP-28
Unit: mm(inch)

Note: Eject hole, oriented hole and mold mark is optional.

Mechanical Dimensions (Continued)
SOIC-24
Unit: mm(inch)

Note: Eject hole, oriented hole and mold mark is optional.



BCD Semiconductor Manufacturing Limited

<http://www.bcdsemi.com>

IMPORTANT NOTICE

BCD Semiconductor Manufacturing Limited reserves the right to make changes without further notice to any products or specifications herein. BCD Semiconductor Manufacturing Limited does not assume any responsibility for use of any its products for any particular purpose, nor does BCD Semiconductor Manufacturing Limited assume any liability arising out of the application or use of any its products or circuits. BCD Semiconductor Manufacturing Limited does not convey any license under its patent rights or other rights nor the rights of others.

MAIN SITE

- Headquarters

BCD Semiconductor Manufacturing Limited

No. 1600, Zi Xing Road, Shanghai ZiZhu Science-based Industrial Park, 200241, China
Tel: +86-21-24162266, Fax: +86-21-24162277

- Wafer Fab

Shanghai SIM-BCD Semiconductor Manufacturing Co., Ltd.

800 Yi Shan Road, Shanghai 200233, China
Tel: +86-21-6485 1491, Fax: +86-21-5450 0008

REGIONAL SALES OFFICE

Shenzhen Office

Shanghai SIM-BCD Semiconductor Manufacturing Co., Ltd., Shenzhen Office

Unit A Room 1203, Skyworth Bldg., Gaoxin Ave. 1.S., Nanshan District, Shenzhen, China
Tel: +86-755-8826 7951
Fax: +86-755-8826 7865

Taiwan Office

BCD Semiconductor (Taiwan) Company Limited

4F, 298-1, Rui Guang Road, Nei-Hu District, Taipei, Taiwan
Tel: +886-2-2656 2808
Fax: +886-2-2656 2806

USA Office

BCD Semiconductor Corp.

30920 Huntwood Ave. Hayward, CA 94544, USA
Tel : +1-510-324-2988
Fax: +1-510-324-2788