1.2A High-Brightness Flash LED Driver with Single-Wire Serial Interface

Features

- Up to 1.2A Flash LED Driving Current
- Highly Efficient, Synchronous Boost Driver (up to 94%)
- $\pm 5\%$ LED Current Accuracy
- Control through Single-Wire Serial Interface or External Control Pins
- Input Voltage Range: 2.7V to 5.5V
- True Load Disconnect
- Configurable Safety Time-Out Protection
- Output Overvoltage Protection (OVP)
- LED Short Detection and Protection
- 1 μ A Shutdown Current
- Available in 14-Pin 3 mm x 2 mm LDFN Package

Applications

- Camera Phones/Mobile Handsets
- Cell Phones/Smartphones
- LED Light for Image Capture/Auto-Focus/White Balance
- Handset Video Light (Torch Light)
- Digital Cameras
- Portable Applications

General Description

The MIC2871 is a high-current, high-efficiency flash LED driver. The LED driver current is generated by an integrated inductive boost converter with a 2 MHz switching frequency, which allows the use of a very small inductor and output capacitor. These features make the MIC2871 an ideal solution for high-resolution camera phone LED flashlight driver applications.

The MIC2871 operates in either Flash or Torch modes that can be controlled through the single-wire serial interface and/or external control pins. Default flash and torch brightness can be adjusted via an external resistor. A robust single-wire serial interface allows simple control by the host processor to support typical camera functions, such as auto-focus, white balance, and image capture (Flash mode).

The MIC2871 is available in a 14-pin 3 mm x 2 mm LDFN package with a junction temperature range of -40°C to $+125^{\circ}\text{C}$.

MIC2871

Package Type

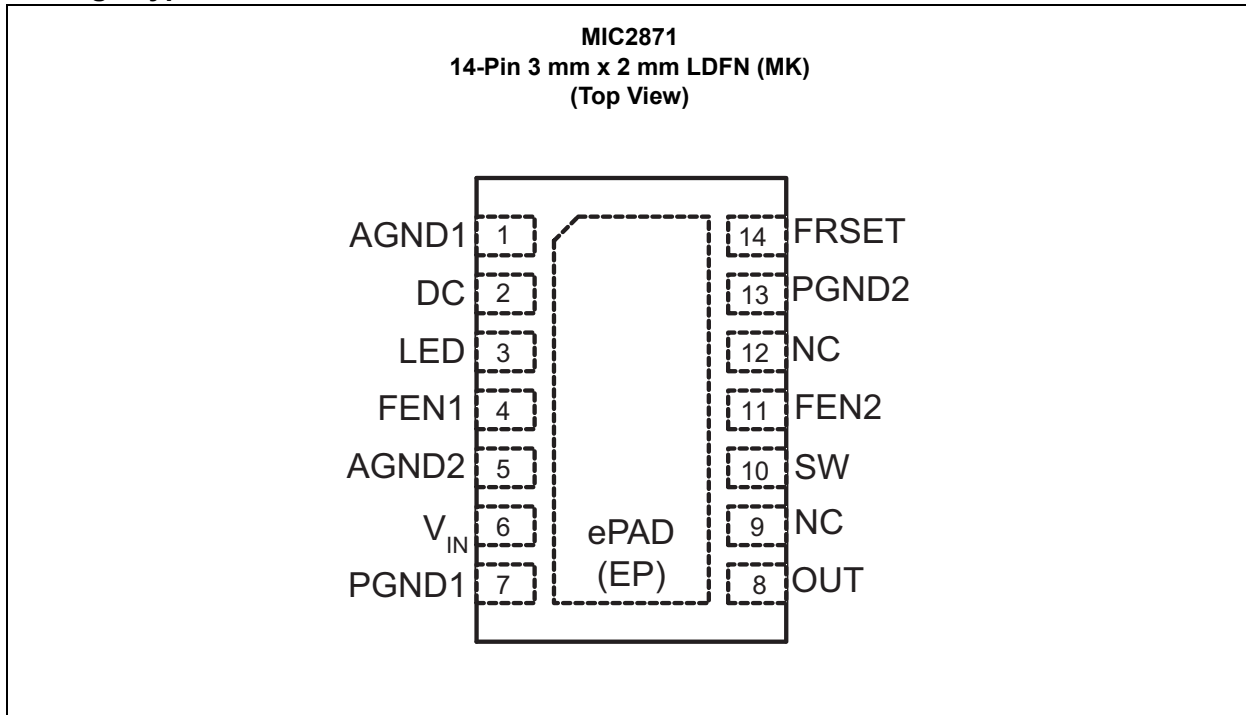

Typical Application Schematic

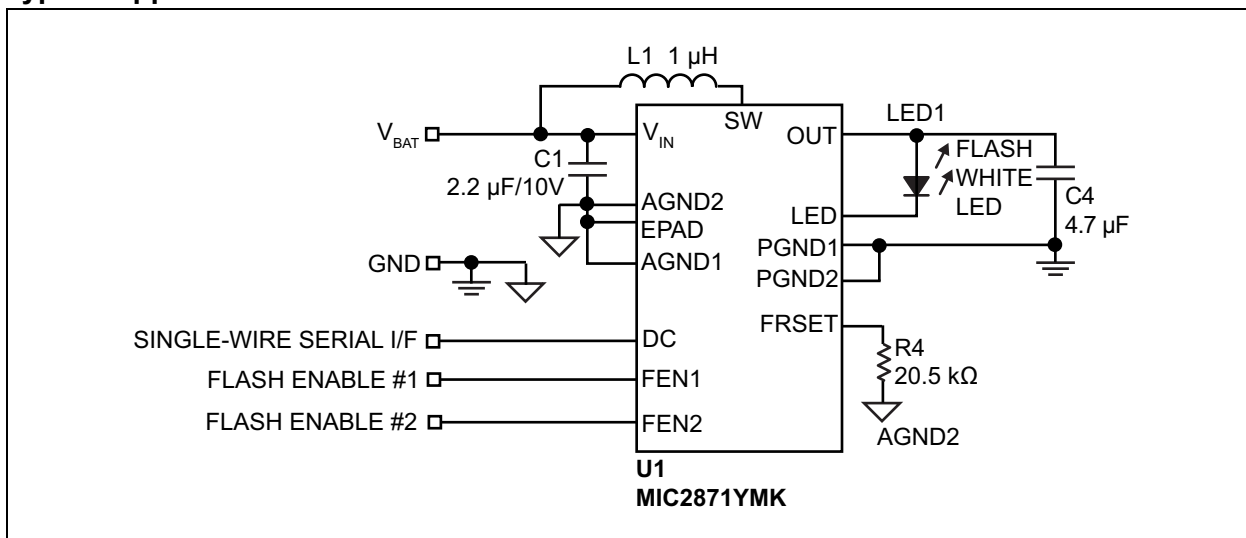

Functional Block Diagram

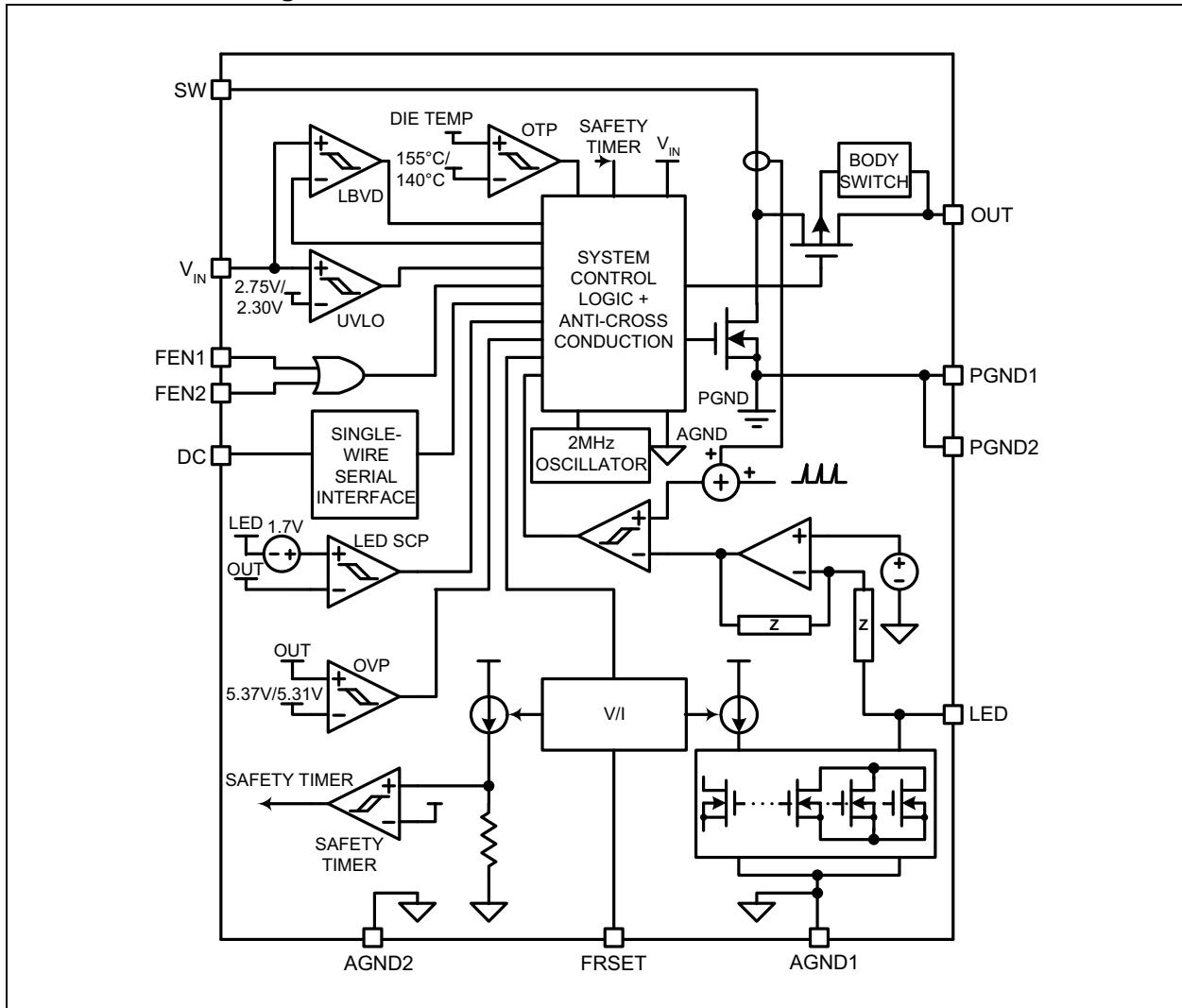

MIC2871

1.0 ELECTRICAL CHARACTERISTICS

Absolute Maximum Ratings†

Input Voltage (V_{IN}).....	-0.3V to +6.0V
General I/O Voltage (V_{FEN1} , V_{FEN2}).....	-0.3V to V_{IN}
V_{OUT} and V_{LED} Voltage.....	-0.3V to +6.0V
Single-Wire I/O Voltage (V_{DC}).....	-0.3V to V_{IN}
V_{FRSET} Voltage.....	-0.3V to V_{IN}
V_{SW} Voltage.....	-0.3V to +6.0V
ESD Rating ⁽¹⁾	2 kV, HBM and 200V, MM

† **Notice:** Stresses above those listed under “Maximum Ratings” may cause permanent damage to the device. This is a stress rating only and functional operation of the device at those or any other conditions above those indicated in the operational sections of this specification is not intended. Exposure to maximum rating conditions for extended periods may affect device reliability.

Note 1: Devices are ESD-sensitive. Handling precautions are recommended. Human body model, 1.5 k Ω in series with 100 pF.

Operating Ratings⁽¹⁾

Input Voltage (V_{IN}).....	+2.7V to +5.5V
Enable Input Voltage (V_{FEN1} , V_{FEN2}).....	0V to V_{IN}
Single-Wire I/O Voltage (V_{DC}).....	0V to V_{IN}
Power Dissipation (P_D).....	Internally Limited ⁽²⁾

Note 1: The device is not ensured to function outside the operating range.

2: The maximum allowable power dissipation at any T_A (ambient temperature) is $P_{D(max)} = (T_{J(max)} - T_A)/\theta_{JA}$.

TABLE 1-1: ELECTRICAL CHARACTERISTICS^(Note 1)

Electrical Specifications: unless otherwise specified, $V_{IN} = 3.6V$; $L = 1 \mu H$; $C_{OUT} = 4.7 \mu F$; $R_{FRSET} = 20.5 k\Omega$; $I_{OUT} = 100 mA$; $T_A = +25^\circ C$. Boldface values indicate $-40^\circ C \leq T_J \leq +125^\circ C$.						
Parameter	Symbol	Min.	Typ.	Max.	Units	Test Conditions
Power Supply						
Supply Voltage Range	V_{IN}	2.7	—	5.5	V	—
Start-up Voltage	V_{START}	—	2.65	2.95	V	—
UVLO Threshold (falling)	$V_{UVLO F}$	—	2.30	2.5	V	—
Standby Current	I_{STB}	—	230	—	μA	$V_{DC} = HIGH$, boost regulator and LED current driver are both off
Shutdown Current	I_{SD}	—	1	2	μA	$V_{DC} = 0V$
Overshoot Protection (OVP) Threshold	V_{OVP}	5.2	5.37	5.55	V	—
OVP Hysteresis	V_{OVPHYS}	—	60	—	mV	—
OVP Blanking Time	$t_{BLANK OVP}$	—	23	—	μs	—
Maximum Duty Cycle	D_{MAX}	82	86	90	%	—
Switch Current Limit	I_{SW}	3.5	4.5	5.5	A	$V_{IN} = V_{OUT} = 2.7V$
Minimum Duty Cycle	D_{MIN}	4	6.4	9	%	—
Switch-On Resistance	$R_{DS(ON) P}$	—	100	—	m Ω	$I_{SW} = 100 mA$
	$R_{DS(ON) N}$					$I_{SW} = 100 mA$

Note 1: Specification for packaged product only.

TABLE 1-1: ELECTRICAL CHARACTERISTICS(Note 1) (CONTINUED)

Electrical Specifications: unless otherwise specified, $V_{IN} = 3.6V$; $L = 1 \mu H$; $C_{OUT} = 4.7 \mu F$; $R_{FRSET} = 20.5 k\Omega$; $I_{OUT} = 100 mA$; $T_A = +25^\circ C$. Boldface values indicate $-40^\circ C \leq T_J \leq +125^\circ C$.						
Parameter	Symbol	Min.	Typ.	Max.	Units	Test Conditions
Switch Leakage Current	I_{SW}	—	0.01	1	μA	$V_{DC} = 0V$, $V_{SW} = 5.5V$
Oscillator Frequency	F_{SW}	—	2	—	MHz	—
Oscillator Frequency Variation	—	-10	—	10	%	—
Overtemperature Shutdown Threshold	T_{SD}	—	155	—	$^\circ C$	—
Overtemperature Shutdown Hysteresis	T_{SDHYS}	—	15	—	$^\circ C$	—
Safety Time-out Shutdown	T_{TO}	—	1.25	—	μs	Default timer setting
Safety Timer Current Threshold	I_{TO}	—	250	—	mA	Default current threshold setting
Safety Timer Current Resolution	—	—	50	—	mA	—
Safety Timer Current Threshold Accuracy	—	—	25	—	mA	—
Low-Battery Voltage Detection Threshold	V_{LBVD}	—	3.6	—	V	Default LBVD threshold setting
Low-Battery Voltage Detection Threshold Accuracy	—	—	50	—	mV	—
LED Short-Circuit Detection Voltage Threshold	V_{SHORT}	—	1.7	—	V	$V_{OUT} - V_{LED}$
LED Short-Circuit Detection Test Current	I_{TEST}	1	2	3	mA	—
Current Sink Channels						
Channel Current Accuracy	—	-5	—	5	%	$3.5V < V_{IN} < 4.2V$, $I_{LED} = 1A$
Current Sink Voltage Dropout	V_{LED}	—	160	—	mV	Boost regulator on, $I_{LED} = 1A$

Note 1: Specification for packaged product only.

MIC2871

TABLE 1-1: ELECTRICAL CHARACTERISTICS^(Note 1) (CONTINUED)

Electrical Specifications: unless otherwise specified, $V_{IN} = 3.6V$; $L = 1 \mu H$; $C_{OUT} = 4.7 \mu F$; $R_{FRSET} = 20.5 k\Omega$; $I_{OUT} = 100 mA$; $T_A = +25^\circ C$. Boldface values indicate $-40^\circ C \leq T_J \leq +125^\circ C$.						
Parameter	Symbol	Min.	Typ.	Max.	Units	Test Conditions
FEN1, FEN2 Control Pins						
FEN1/FEN2 High-Level Voltage	V_{FEN_H}	1.5	—	—	V	Flash on
FEN1/FEN2 Low-Level Voltage	V_{FEN_L}	—	—	0.4		Flash off
FEN1/FEN2 Pull-Down Current	I_{FEN_PD}	—	1	5	μA	$V_{FEN1} = V_{FEN2} = 5.5V$

Note 1: Specification for packaged product only.

TABLE 1-2: ELECTRICAL CHARACTERISTICS – SINGLE-WIRE INTERFACE⁽¹⁾

Electrical Specifications: unless otherwise specified, $V_{IN} = 3.6V$; $L = 1 \mu H$; $C_{OUT} = 4.7 \mu F$; $I_{OUT} = 100 mA$; $T_A = 25^\circ C$. Boldface values indicate $-40^\circ C \leq T_J \leq +125^\circ C$.						
Parameter	Symbol	Min.	Typ.	Max.	Units	Test Conditions
Low-Level Input Voltage	V_L	—	—	0.4	V	—
High-Level Input Voltage	V_H	1.5	—	—	V	—
DC Pull-Down Current	I_{DC_PD}	—	2.5	5	μA	$V_{DC} = 5.5V$
On Time	T_{ON}	0.1	—	72	μs	—
Off Time	T_{OFF}	0.1	—	72	μs	—
Latch Time	T_{LAT}	97	—	324	μs	—
End Time	T_{END}	405	—	—	μs	—

Note 1: Design guidance only.

TEMPERATURE SPECIFICATIONS (Note 1)

Parameters	Symbol	Min.	Typ.	Max.	Units	Conditions
Temperature Ranges						
Maximum Junction Temperature Range	T_J	-40	—	150	°C	—
Operating Junction Temperature Range	T_J	-40	—	125	°C	—
Storage Temperature	T_S	-40	—	150	°C	—
Lead Temperature	—	—	—	260	°C	Soldering, 10s
Package Thermal Resistance						
Thermal Resistance 3x2 LDFN-14LD	θ_{JA}	—	65.83	—	°C/W	—
	θ_{JC}	—	38.9	—		—

Note 1: The maximum allowable power dissipation is a function of ambient temperature, the maximum allowable junction temperature and the thermal resistance from junction to air (i.e., T_A , T_J , θ_{JA}). Exceeding the maximum allowable power dissipation will cause the device operating junction temperature to exceed the maximum +150°C rating. Sustained junction temperatures above +150°C can impact the device reliability.

MIC2871

2.0 TYPICAL PERFORMANCE CURVES

Note: The graphs and tables provided following this note are a statistical summary based on a limited number of samples and are provided for informational purposes only. The performance characteristics listed herein are not tested or guaranteed. In some graphs or tables, the data presented may be outside the specified operating range (e.g., outside specified power supply range) and therefore outside the warranted range.

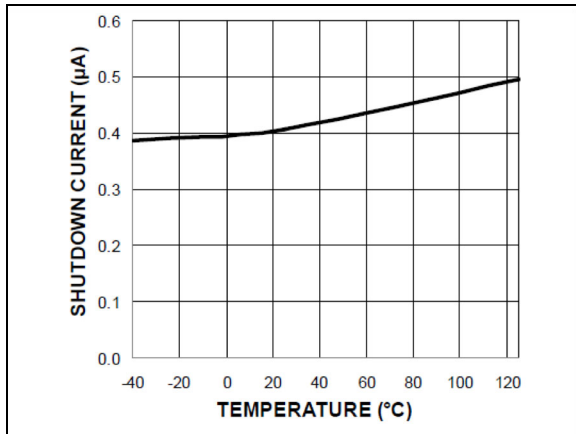

FIGURE 2-1: Shutdown Current vs. Temperature.

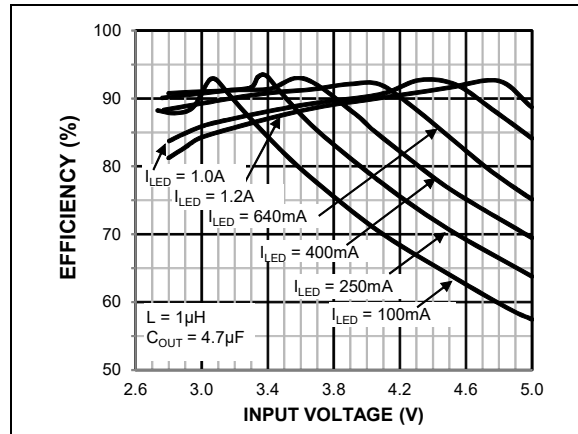

FIGURE 2-4: WLED Power Efficiency vs. Input Voltage.

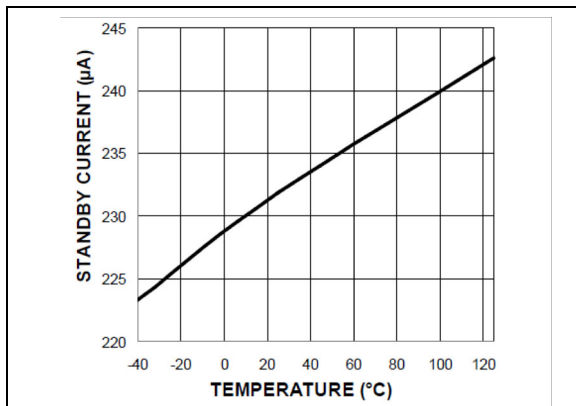

FIGURE 2-2: Standby Current vs. Temperature.

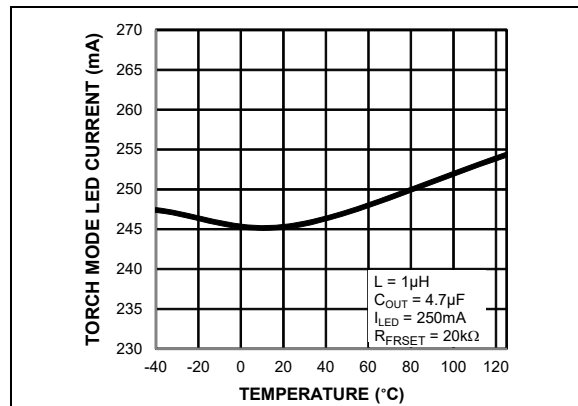

FIGURE 2-5: Torch Mode LED Current vs. Temperature.

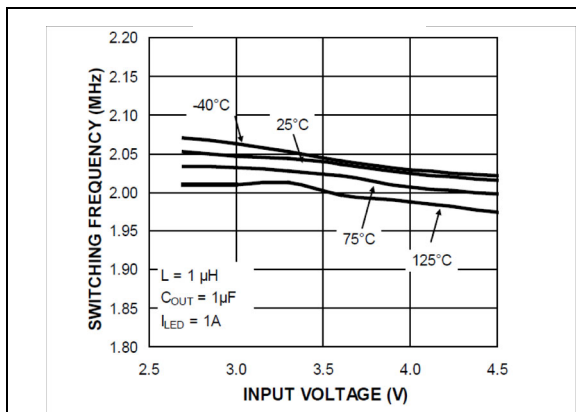

FIGURE 2-3: Boost Switching Frequency vs. Input Voltage.

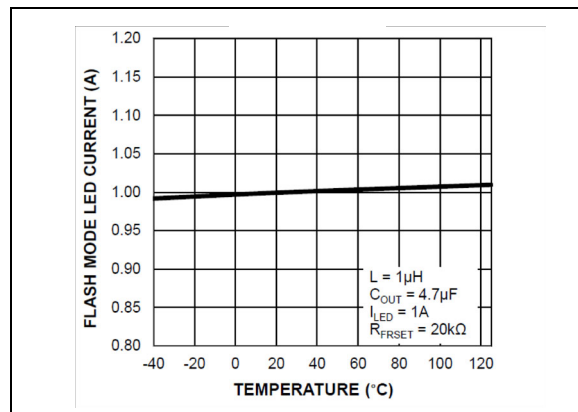

FIGURE 2-6: Flash Mode LED Current vs. Temperature.

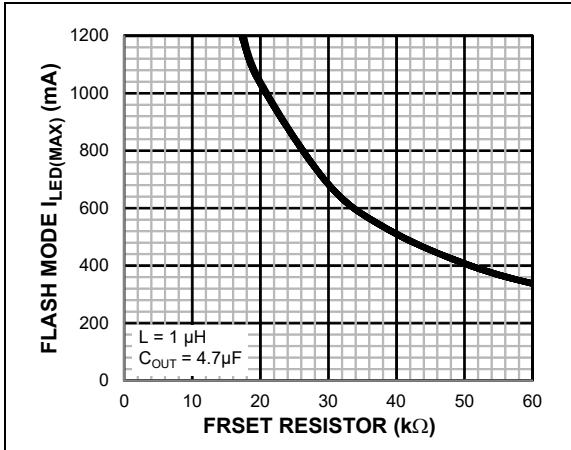

FIGURE 2-7: Flash Mode $I_{LED(MAX)}$ vs. $FRSET$ Resistor.

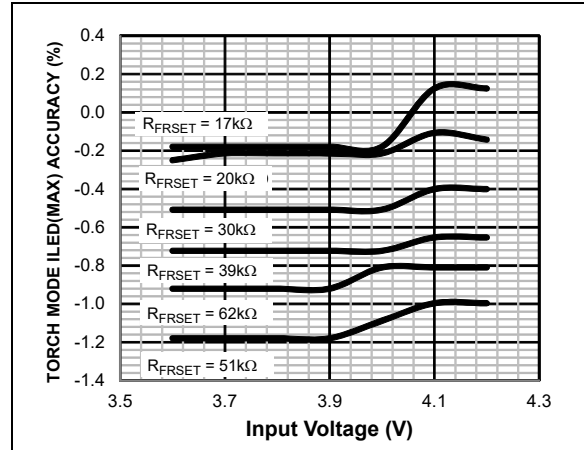

FIGURE 2-10: Torch Mode $I_{LED(MAX)}$ Accuracy vs. Input Voltage.

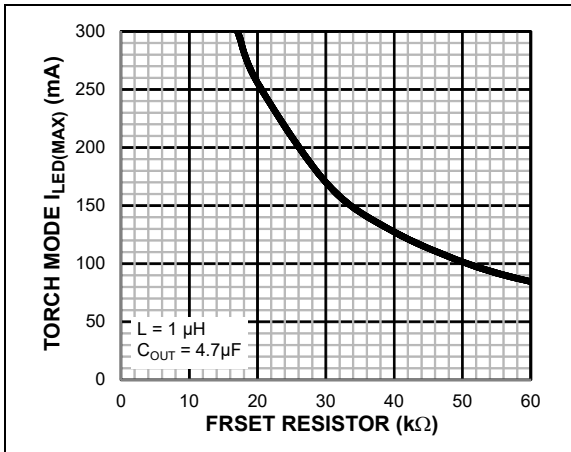

FIGURE 2-8: Torch Mode $I_{LED(MAX)}$ vs. $FRSET$ Resistor.

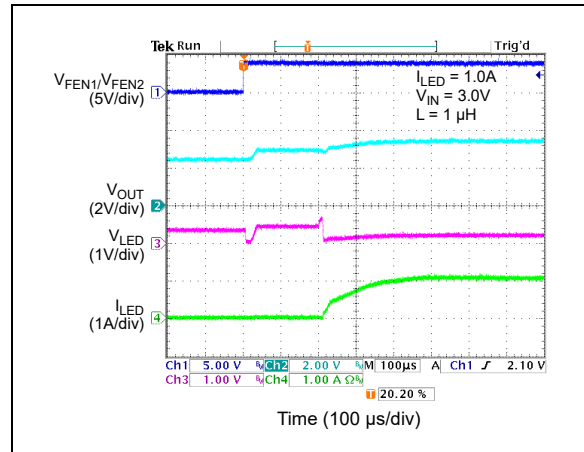

FIGURE 2-11: Flash Mode Turn-On Sequence (Boost Mode).

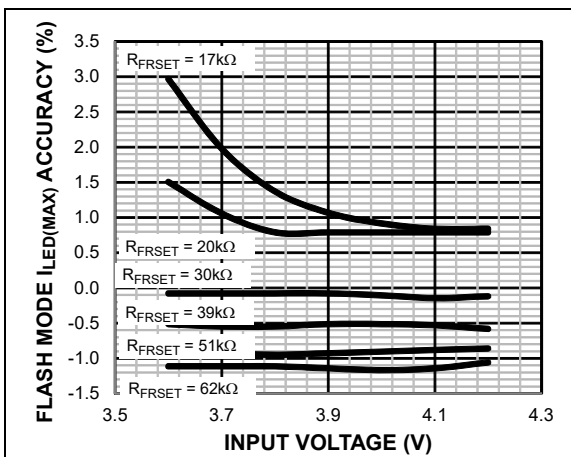

FIGURE 2-9: Flash Mode $I_{LED(MAX)}$ Accuracy vs. Input Voltage.

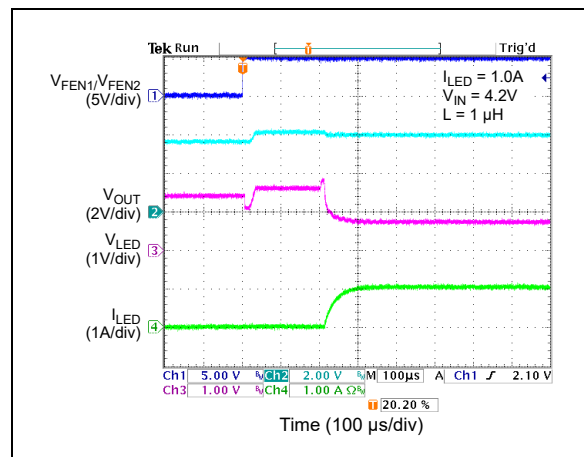

FIGURE 2-12: Flash Mode Turn-On Sequence (Linear Mode).

MIC2871

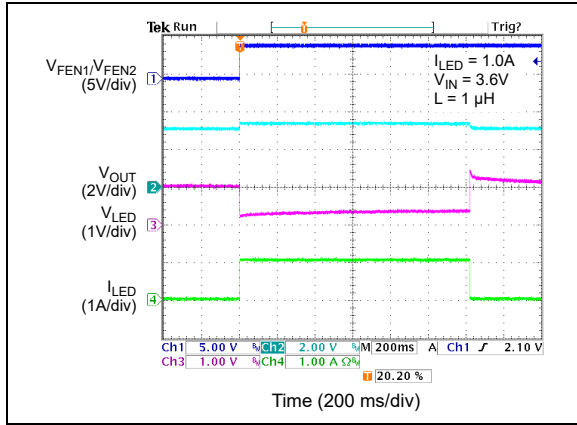

FIGURE 2-13: Flash Safety Timer at 1250 ms.

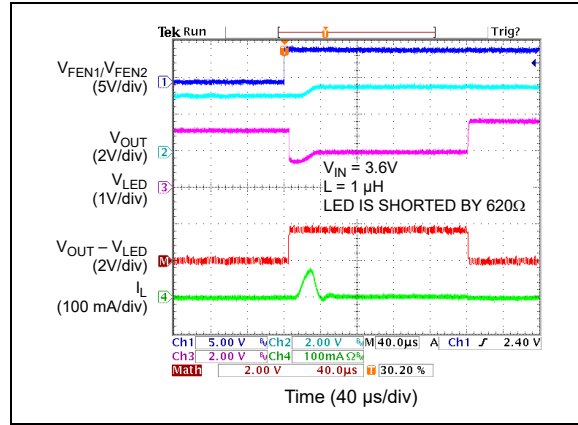

FIGURE 2-15: LED Short-Circuit Protection.

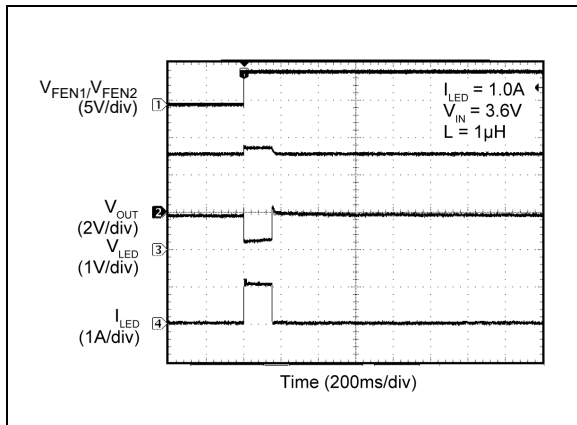

FIGURE 2-14: Flash Safety Timer at 156 ms.

3.0 PIN DESCRIPTIONS

The descriptions of the pins are listed in [Table 3-1](#).

TABLE 3-1: PIN FUNCTION TABLE

MIC2871 Pin Number	Pin Name	Pin Function
1	AGND1	Analog Ground: LED current return path.
2	DC	Single-wire serial interface control input.
3	LED	LED Current Sink Pin: Connect the LED anode to OUT and cathode to this pin.
4	FEN1	Flash Mode Enable Pin: Toggling FEN1 from LOW to HIGH enables MIC2871 into the Flash mode. FEN1 is logic-OR with FEN2. If this pin is left floating, it is pulled down internally by a built-in 1 μ A current source when the device is enabled.
5	AGND2	Analog Ground: Reference ground of the FRSET pin.
6	V _{IN}	Supply Input Pin: Connect a low-ESR ceramic capacitor of at least 2.2 μ F to AGND2.
7	PGND1	Power Ground: Inductor current return path.
8	OUT	Boost Converter Output Pin: This is connected to the anode of the LED. Connect a low-ESR ceramic capacitor of at least 4.7 μ F to PGND1.
9, 12	NC	No Connect: Connect this pin to AGND or leave it floating.
10	SW	Inductor Connection Pin: It is connected to the internal power MOSFETs.
11	FEN2	Additional Flash Mode Enable Pin: FEN2 is logic-OR with FEN1. If this pin is left floating, it is pulled down internally by a built-in 1 μ A current source when the device is enabled.
13	PGND2	Power Ground.
14	FRSET	Flash Mode Current-Level Programming Pin: Connect a resistor from this pin to AGND2 to set the maximum current in the Flash mode. This pin may be grounded if the default Flash mode current (1A) is desired. This pin cannot be left floating and the recommended resistance range is from 17 k Ω to 60 k Ω .
EP	ePAD	Exposed Heat Sink Pad: Connect to ground for best thermal performance.

MIC2871

4.0 FUNCTIONAL DESCRIPTION

4.1 V_{IN}

The input supply provides power to the internal MOSFETs' gate drive and controls circuitry for the switch mode regulator. The operating input voltage range is from 2.7V to 5.5V. A 2.2 μ F low-ESR ceramic input capacitor should be connected from V_{IN} to AGND2 as close to the MIC2871 as possible to ensure a clean supply voltage for the device. The minimum voltage rating of 10V is recommended for the input capacitor.

4.2 SW

The MIC2871 has internal low-side and synchronous MOSFET switches. The switch node (SW) between the internal MOSFET switches connects directly to one end of the inductor and provides the current paths during switching cycles.

The other end of the inductor is connected to the input supply voltage. Due to the high-speed switching on this pin, the switch node should be routed away from sensitive nodes wherever possible.

4.3 AGND1

This is the ground path of the LED current sink. It should be connected to the AGND2, but not via an exposed pad on the PCB. The current loop of the Analog Ground should be separated from that of the Power Ground (PGND1 and PGND2). AGND1 and AGND2 should be connected to PGND1 and PGND2 at a single point.

4.4 AGND2

This is the ground path for the internal biasing and control circuitry. AGND2 should be connected to the PCB pad for the package exposed pad. AGND2 should be connected to the AGND1 directly without going through the exposed pad. The current loop of the analog ground should be separated from that of the Power Ground (PGND1 and PGND2). The AGND2 and AGND1 should be connected to PGND1 and PGND2 at a single point.

4.5 PGND1 and PGND2

The Power Ground pins are the ground path for the high current in the boost switch and they are internally connected together. The current loop for the Power Ground should be as small as possible and separate from the Analog Ground (AGND) loop as applicable.

4.6 OUT

This is the boost converter output pin which is connected to the anode of the LED. A low-ESR ceramic capacitor of 4.7 μ F or larger should be connected from OUT to PGND1, as close as possible to the MIC2871. The minimum voltage rating of 10V is recommended for the output capacitor.

4.7 LED

This is the current sink pin for the LED. The LED anode is connected to the OUT pin and the LED cathode is connected to this pin.

4.8 DC

The DC is a single multiplexed device enable, and serial data control pin used for functional control and communication in GPIO limited applications. When the DC pin is used as a hardware device enable pin, a logic high signal on the DC pin enables the device, and a logic low signal on the DC pin disables the device. When the DC pin is used as the single-wire serial interface digital control pin, a combination of bit edges and the period between edges is used to communicate a variable length data word across the single wire. Each word is transmitted as a series of pulses, each pulse incrementing an internal data counter. A stop sequence consisting of an inactive period is used to latch the data word internally. The data word received is then used to set the value of the corresponding register for controlling the specific function. The MIC2871 supports five writable registers for controlling Flash mode, Torch mode, safety timer duration, safety timer threshold current and low-battery threshold.

An address/data frame is used to improve protection against erroneous writes where communications are in error. When the DC is in a low state and no data is detected for an extended period of time, the MIC2871 will automatically go into a low-power Shutdown state, simultaneously resetting all internal registers to their default states.

4.9 FEN1 and FEN2

FEN1 and FEN2 are hardware enable pins for Flash mode. FEN1 is logic-OR with FEN2. A logic low-to-high transition on either the FEN1 pin or FEN2 pin can initiate the MIC2871 in Flash mode. If FEN1 or FEN2 is left floating, it is pulled down internally by a built-in 1 μ A current source when the device is enabled. Flash mode is terminated when both FEN1 and FEN2 are pulled low or left floating, and the Flash register is cleared.

4.10 FRSET

The Flash mode maximum LED current level is programmed through the FRSET pin. A resistor connected from the FRSET pin to AGND2 sets the maximum current in the Flash mode. This pin can be grounded if the default Flash mode current of 1A is desired. For the best current accuracy, a 0.1% or smaller tolerance resistor for setting the maximum Flash mode LED current is recommended. This pin cannot be left floating and the minimum resistance is limited to 17 k Ω . The maximum Flash mode current to maximum Torch mode current ratio is internally fixed as 4 to 1.

5.0 APPLICATION INFORMATION

The MIC2871 can drive a high-current Flash WLED in either Flash mode or Torch mode.

5.1 Boost Converter

The internal boost converter is turned on/off automatically when the LED driver is activated/deactivated without any exception.

The boost converter is an internally compensated Current mode PWM boost converter running at 2 MHz. It is for stepping up the supply voltage to a high enough value at the OUT pin to drive the LED current. If the supply voltage is high enough, the synchronous switch of the converter is then fully turned on. In this case, all the excessive voltage is dropped over the linear LED driver.

5.2 Flash Mode

The maximum current level in the Flash mode is 1.2A. This current level can be adjusted through an external resistor connected to the FRSET pin according to [Equation 5-1](#):

EQUATION 5-1: CURRENT LEVEL ADJUSTMENT

$$I_{LED(MAX)} = \frac{20500}{R_{FRSET}}$$

Alternatively, the default value of 1A is used when the FRSET pin is grounded.

The Flash mode current can be initiated at this preset FRSET brightness level by asserting the FEN1 or FEN2 pin high, or by setting the Flash Control register (Address 1) for the desired Flash duration, subjected to the safety time-out setting. The Flash mode current is terminated when the FEN1 and FEN2 pins are brought low and the Flash register is cleared.

Flash mode current can be adjusted to a fraction of the maximum Flash mode current level by selecting the desired percentage in the Flash Control register through the single-wire serial interface. The Flash current is the product of the maximum Flash current setting and the percentage selected in the Flash register.

5.3 Torch Mode

By default, the maximum Torch mode level is one-fourth (1/4) of the maximum Flash mode current. The Torch mode operation is activated by setting the Torch Control register (Address 2) for the desired duration. The Torch mode current is terminated when the Torch register is cleared or when the configurable safety timer expires.

Like the Flash mode current, the Torch mode current can be tuned to a fraction of the maximum Torch mode level by selecting the desired torch current level percentage in the Torch Control register (Address 2) through the single-wire serial interface.

The torch current is the product of the maximum torch current setting and the percentage selected in the Torch register.

5.4 Configurable Safety Timer

The Flash safety time-out feature automatically shuts down the LED current, after the safety timer duration is expired, if the programmed LED current exceeds a certain current threshold. Both the current threshold and the timer duration are programmable via the Safety Timer registers (Addresses 3 and 5).

5.5 Low-Battery Voltage Detection (LBVD)

When the V_{IN} voltage drops below the LBVD threshold (default = 3.6V) in flash or torch mode, the LED current driver is disabled. The LED driver can be resumed by toggling the corresponding input control signal. The LBVD threshold is adjustable through the LBVD Control register (Address 4).

5.6 Overvoltage Protection

When the output voltage rises above the over voltage protection threshold (OVP), MIC2871 is latched off automatically to avoid permanent damage to the IC. To clear the latched off condition, either power cycle the MIC2871 or assert the DC pin low.

5.7 Short-Circuit Detection

Each time before enabling the LED driver, the MIC2871 performs the short-circuit test by driving the Flash LED with a small (2 mA typical) current for 200 μ s. If $(V_{OUT} - V_{LED}) < 1.7V$ at the end of the short-circuit test, the LED is considered to be shorted and MIC2871 will ignore the Flash and/or Torch mode command. Note that the short-circuit test is carried out every time prior to Flash and Torch mode, but the result is not latched.

5.8 Thermal Shutdown

When the internal die temperature of MIC2871 reaches +155°C, the LED driver is disabled until the die temperature falls below +140°C.

MIC2871

5.9 Single-Wire Interface

The single-wire interface allows the use of a single multiplexed enable and data pin (DC) for control, and communication in GPIO limited applications. The interface is implemented using a simple mechanism, allowing any open-drain or directly driven GPIO to control the MIC2871.

The MIC2871 uses the single-wire interface for simple command and control functions. The interface provides fast access to write-only registers with protection features to avoid potentially erroneous data writes and improve robustness. When the DC is in a low state and no data is detected for an extended period of time, the MIC2871 will automatically go into a low-power shutdown state, simultaneously resetting internal registers to their default states.

5.10 Overview

The single-wire interface relies on a combination of bit edges, and the period between edges, in order to communicate across a single wire. Each word is transmitted as a series of pulses, with each pulse incrementing an internal data counter. A stop sequence consisting of an inactive period is used to latch the data word internally. An address and data framing format is used to improve protection against erroneous writes by enforcing address and data field lengths, as well as the timing duration between them.

Timing is designed such that when communicating with a device using a low-cost on-chip oscillator, the worst-case minimum and maximum conditions can be easily met within the wide operating range of the oscillator. Using this method ensures that the device can always detect the delay introduced by the communication master.

5.11 Idle States and Error Conditions

In Shutdown mode, the MIC2871 is in a Reset condition, with all functions off, while consuming minimal power. Register settings are reset to their default state when coming out of Shutdown state. In Idle mode, all register settings persist and all MIC2871 functions continue in their current state. [Table 5-1](#) summarizes the difference between the two IDLE modes:

TABLE 5-1: DIFFERENCES BETWEEN IDLE MODES

DC	Shutdown	Idle
	Low	High
I_{SUPPLY} (all functions off)	1 μA	230 μA
Register State	Default	Persist
Start-up Time	1 μs	100 ns

Idle mode is entered automatically at the end of a communication frame by holding DC high for $\geq T_{END}$, by enabling the device by bringing DC high when in shutdown mode, or when an error is detected by the single-wire interface logic.

Shutdown mode can be entered at any time by pulling down DC for $\geq T_{END}$, discarding any current communication and resetting the internal registers. If a communication is received before the shutdown period, but after the T_{LAT} period, the communication is discarded. This state is also used to create an internal error state to avoid erroneously latching data where the communication process cannot be serviced in time. Additionally, each register has a maximum value associated with it. If the number of bits clocked in exceeds the maximum value for the register, the data is assumed to be in error and the data is discarded.

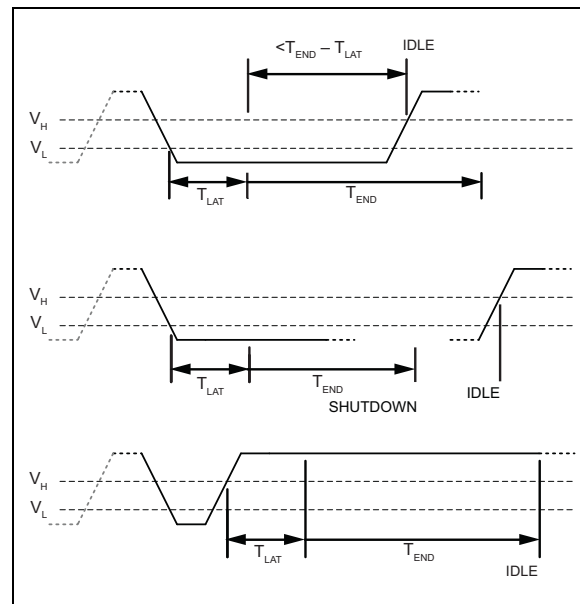

FIGURE 5-1: Abort, Shutdown and Idle Timing Waveforms.

5.12 Communication Details

The serial interface requires delimiters to indicate the Start-of-Frame (SOF), data as a series of pulses and End-of-Frame (EOF) indicated by a lack of activity. The Start-of-Frame is the first high-to-low transition of the DC when in Idle mode. The first rising edge resets the internal data counter to 0.

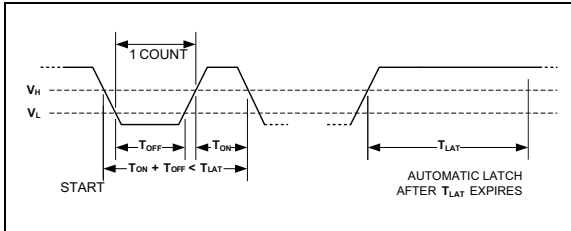

FIGURE 5-2: Data Word Pulse Timing.

A pulse is delimited by the signal first going below V_L and then above V_H within the Latch Time-out, T_{LAT} . During this transition, the minimum on (T_{ON}) and off (T_{OFF}) periods are observed to improve tolerance to glitches. Each rising edge increments the internal Data register. Data is automatically latched into the internal Shadow Address and Data registers after an inactivity period of $>T_{LAT}$.

To send register write commands, the address and data are entered in series as two data words using the above pattern, with the second word starting after the first latch period has expired. After the second word is entered, the `IDLE` command should be issued by leaving the DC pins high for $\geq T_{END}$.

After receiving the stop sequence, the internal registers' decode and update cycle is started, with the Shadow register values being transferred to the decoder. Figure 5-3 shows an example of entering a write of Data 5 to Address 3.

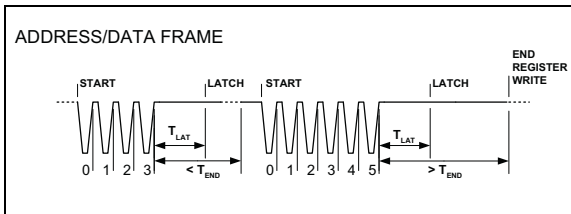

FIGURE 5-3: Communication Timing Example of Entering Write for Data 5 to Address 3.

Only a correctly formatted address/data combination will be treated as a valid frame and processed by the MIC2871. Any other input, such as a single data word followed by T_{END} , or three successive data words, will be discarded by the target hardware as an erroneous entry. Additionally, any register write to either an invalid register or with invalid register data will also be discarded.

5.13 MIC2871 Registers

The MIC2871 supports five writable registers for controlling the Torch and Flash modes of operation, as shown in Table 5-2. Note that register addressing starts at 1. Writing any value above the maximum value shown for each register will cause an invalid data error and the frame will be discarded.

TABLE 5-2: FIVE WRITABLE REGISTERS OF MIC2871

Address	Name	Max. Value	Description
1	FEN/FCUR	31	Flash Enable/Current
2	TEN/TCUR	31	Touch Enable/Current
3	STDUR	7	Safety Timer Duration
4	LB_TH	9	Low-Battery Voltage Detection Threshold
5	ST_TH	5	Safety Timer Threshold

MIC2871

5.13.1 FLASH CURRENT REGISTER (FEN/FCUR: DEFAULT 0)

The Flash Current register enables and sets the Flash mode current level. Valid values are 0 to 31; Values 0-15 will set the Flash current without enabling the Flash (such that it can be triggered externally), Values 16-31 will set the Flash current and enable the Flash. The Flash Current register maps into the internal FEN and FCUR registers, as shown in Table 5-3. Table 5-3 describes the relationship between the Flash current, as a percentage of maximum current, and the FCUR register setting.

TABLE 5-3: FLASH CURRENT REGISTER MAPPING INTO INTERNAL FEN/FCUR REGISTERS AND RELATIONSHIP BETWEEN FLASH CURRENT AS % OF MAX. CURRENT AND FCUR REGISTER SETTING

Value		FEN/FCUR<4:0>	
Dec.	Binary	FEN<4>	FCUR<3:0> % of I _{MAX}
0	00000	0	100.00
1	00001	0	88.96
2	00010	0	79.04
3	00011	0	70.72
4	00100	0	63.04
5	00101	0	56.00
6	00110	0	49.92
7	00111	0	44.64
8	01000	0	39.68
9	01001	0	35.52
10	01010	0	31.68
11	01011	0	28.16
12	01100	0	25.12
13	01101	0	22.40
14	01110	0	20.00
15	01111	0	17.92
16	10000	1	100.00
17	10001	1	88.96
18	10010	1	79.04
19	10011	1	70.72
20	10100	1	63.04
21	10101	1	56.00
22	10110	1	49.92
23	10111	1	44.64
24	11000	1	39.68
25	11001	1	35.52
26	11010	1	31.68
27	11011	1	28.16
28	11100	1	25.12
29	11101	1	22.40
30	11110	1	20.00
31	11111	1	17.92

5.13.2 TORCH CURRENT REGISTER (TEN/TCUR: DEFAULT 0)

The Torch Current register enables and sets the Torch mode current level. Valid values are 0 to 31; Values 0-15 will set the torch current without enabling the torch (such that it can be triggered by setting the internal TEN register value to 1), Values 16-31 will set the torch current and enable the torch. A value of 0 at the internal TEN register will disable the torch. The Torch Current register maps into the internal TEN and TCUR registers, as shown in Table 5-4. The table also describes the relationship between the torch current as a percentage of maximum current, and the TCUR register setting.

TABLE 5-4: TORCH CURRENT REGISTER MAPPING INTO INTERNAL TEN/TCUR REGISTERS AND RELATIONSHIP BETWEEN TORCH CURRENT AS % OF MAX. CURRENT AND TCUR REGISTER SETTING

Value		TEN/TCUR<4:0>	
Dec.	Binary	TEN<4>	TCUR<3:0> % of I _{MAX}
0	00000	0	100.00
1	00001	0	88.96
2	00010	0	79.04
3	00011	0	70.72
4	00100	0	63.04
5	00101	0	56.00
6	00110	0	49.92
7	00111	0	44.64
8	01000	0	39.68
9	01001	0	35.52
10	01010	0	31.68
11	01011	0	28.16
12	01100	0	25.12
13	01101	0	22.40
14	01110	0	20.00
15	01111	0	17.92
16	10000	1	100.00
17	10001	1	88.96
18	10010	1	79.04
19	10011	1	70.72
20	10100	1	63.04
21	10101	1	56.00
22	10110	1	49.92
23	10111	1	44.64
24	11000	1	39.68
25	11001	1	35.52
26	11010	1	31.68
27	11011	1	28.16
28	11100	1	25.12
29	11101	1	22.40
30	11110	1	20.00
31	11111	1	17.92

5.13.3 SAFETY TIMER DURATION REGISTER (STDUR: DEFAULT 7)

The Safety Timer Duration register sets the duration of the Flash and Torch modes when the LED current exceeds the programmed threshold current. Valid values are 0 for the minimum timer duration to 7 for the maximum duration.

TABLE 5-5: SAFETY TIMER DURATION REGISTER SETTING AND SAFETY TIMER DURATION

Value		STDUR<2:0> (binary)	Time-out (ms)
Dec.	Binary		
0	000	000	156.25
1	001	001	312.5
2	010	010	468.75
3	011	011	625
4	100	100	781.25
5	101	101	937.5
6	110	110	1093.75
7	111	111	1250

5.13.4 LOW-BATTERY THRESHOLD REGISTER (LB_TH: DEFAULT 7)

The LB_TH register sets the supply threshold voltage below which the internal low-battery flag is asserted and Flash functions are inhibited. [Table 5-6](#) shows the threshold values that correspond to the register settings. Setting 0 is reserved for disabling the function, and settings between 1 and 9 inclusively enable and set the LB_TH value, between 3.0V and 3.8V with 100 mV resolution.

TABLE 5-6: LOW-BATTERY THRESHOLD REGISTER SETTING AND SUPPLY THRESHOLD VOLTAGE

Value		LB_TH<3:0>	V _{BAT} Threshold (V)
Dec.	Binary		
0	0000	0000	Disabled
1	0001	0001	3.0
2	0010	0010	3.1
3	0011	0011	3.2
4	0100	0100	3.3
5	0101	0101	3.4
6	0110	0110	3.5
7	0111	0111	3.6
8	1000	1000	3.7
9	1001	1001	3.8

5.13.5 SAFETY TIMER THRESHOLD CURRENT REGISTER (ST_TH: DEFAULT 4)

The Safety Timer Threshold Current register determines the amount of LED current flowing through the external LED before the internal LED safety timer is activated. Setting ST_TH to 0 disables the safety timer function, and setting the register to Values 1 to 5 set the safety time threshold current to 100 mA to 300 mA in 50 mA steps.

TABLE 5-7: SAFETY TIMER THRESHOLD CURRENT REGISTER SETTING AND SAFETY TIMER THRESHOLD CURRENT

Value		ST_TH<2:0>	Safety Timer Threshold Current (mA)
Dec.	Binary		
0	000	000	Disabled
1	001	001	100 mA
2	010	010	150 mA
3	011	011	200 mA
4	100	100	250 mA
5	101	101	300 mA

6.0 COMPONENT SELECTION

6.1 Inductor

Inductor selection is a balance between efficiency, stability, cost, size, and rated current. Because the boost converter is compensated internally, the recommended inductance of L is limited from 1 μH to 2.2 μH to ensure system stability. It is usually a good balance between these considerations.

A large inductance value reduces the peak-to-peak inductor ripple current; hence, the output ripple voltage and the LED ripple current. This also reduces both the DC loss and the transition loss at the same inductor's DC Resistance (DCR). However, the DCR of an inductor usually increases with the inductance in the same package size. This is due to the longer windings required for an increase in inductance. Because the majority of the input current passes through the inductor, the higher the DCR, the lower the efficiency is, and more significantly, at higher load currents. On the other hand, an inductor with a smaller DCR, but the same inductance, usually has a larger size. The saturation current rating of the selected inductor must be higher than the maximum peak inductor current to be encountered and should be at least 20% to 30% higher than the average inductor current at maximum output current.

6.2 Input Capacitor

A ceramic capacitor of 2.2 μF or larger with low-ESR is recommended to reduce the input voltage ripple to ensure a clean supply voltage for the device. The input capacitor should be placed as close as possible to the MIC2871 V_{IN} pin with a short trace for good noise performance. X5R or X7R type ceramic capacitors are recommended for better tolerance over temperature. The Y5V and Z5U type temperature rating ceramic capacitors are not recommended due to their large reduction in capacitance over temperature and increased resistance at high frequencies. These reduce their ability to filter out high-frequency noise. The rated voltage of the input capacitor should be at least 20% higher than the maximum operating input voltage over the operating temperature range.

6.3 Output Capacitor

Output capacitor selection is also a trade-off between performance, size and cost. Increasing the output capacitor will lead to an improved transient response, however, the size and cost also increase. The output capacitor is preferred in the range of 2.2 μF to 10 μF , with ESR from 10 $\text{m}\Omega$ to 50 $\text{m}\Omega$. X5R or X7R type ceramic capacitors are recommended for better tolerance over temperature.

The Y5V and Z5U type ceramic capacitors are not recommended due to their wide variation in capacitance over temperature and increased resistance at high frequencies. The rated voltage of the output capacitor should be at least 20% higher than the maximum operating output voltage over the operating temperature range.

6.4 FRSET Resistor

Because the FRSET resistor is used for setting the maximum LED current, a resistor type with 0.1% tolerance is recommended for a more accurate maximum LED current setting.

7.0 POWER DISSIPATION CONSIDERATION

As with all power devices, the ultimate current rating of the output is limited by the thermal properties of the device package and the PCB on which the device is mounted. There is a simple Ω 's law type relationship between thermal resistance, power dissipation and temperature, which are analogous to an electrical circuit:

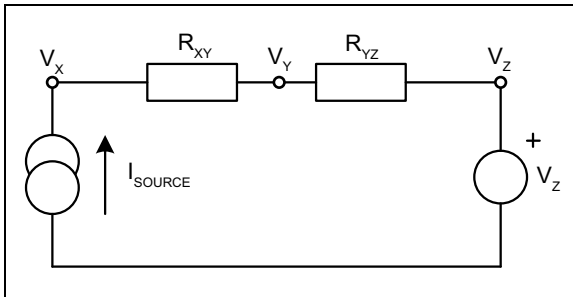

FIGURE 7-1: Series Electrical Resistance Circuit.

From this simple circuit, we can calculate V_X if we know the I_{SOURCE} , V_Z and resistor values, R_{XY} and R_{YZ} , using [Equation 7-1](#):

EQUATION 7-1: CALCULATING V_X

$$V_X = I_{SOURCE} \times (R_{XY} + R_{YZ}) + V_Z$$

Thermal circuits can be considered using this same rule and can be drawn similarly by replacing current sources with power dissipation (in watts), resistance with thermal resistance (in $^{\circ}C/W$) and voltage sources with temperature (in $^{\circ}C$).

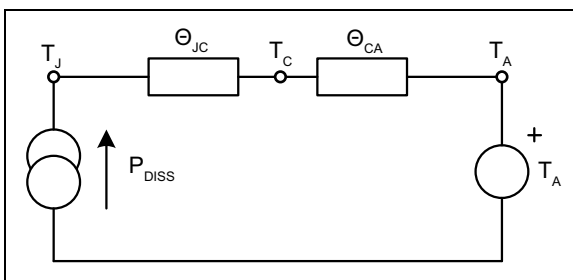

FIGURE 7-2: Series Thermal Resistance Circuit.

Now replacing the variables in [Equation 7-1](#), we can find the Junction Temperature (T_J) from the power dissipation, ambient temperature, and the known thermal resistance of the PCB (θ_{CA}) and the package (θ_{JC}).

EQUATION 7-2: FINDING THE JUNCTION TEMPERATURE (T_J)

$$T_J = P_{DISS} \times (\theta_{JC} + \theta_{CA}) + T_A$$

As can be seen in the diagram, the total thermal resistance is: $\theta_{JA} = \theta_{JC} + \theta_{CA}$. Hence, this can also be written as in [Equation 7-3](#):

EQUATION 7-3: TOTAL THERMAL RESISTANCE

$$T_J = P_{DISS} \times (\theta_{JA}) + T_A$$

Where:

θ_{JA} = Thermal resistance between junction and ambient, which is typically $65.83^{\circ}C/W$ for 3 mm x 2 mm LDFN package

Because effectively all of the power losses (minus the inductor losses) in the converter are dissipated within the MIC2871 package, P_{DISS} can be calculated thus:

EQUATION 7-4: CALCULATING P_{DISS}

$$\text{Linear Mode: } P_{DISS} = [P_{OUT} \times \left(\frac{1}{\eta} - 1\right)] - I_{OUT}^2 \times DCR$$

$$\text{Boost Mode: } P_{DISS} = [P_{OUT} \times \left(\frac{1}{\eta} - 1\right)] - \left(\frac{I_{OUT}}{1-D}\right)^2 \times DCR$$

$$\text{Duty Cycle in Boost Mode: } D = \frac{V_{OUT} - V_{IN}}{V_{OUT}}$$

Where:

η = Efficiency taken from efficiency curves
DCR = Inductor DCR

MIC2871

Where the real board area differs from 1" square, θ_{CA} (the PCB thermal resistance) values for various PCB copper areas can be taken from [Figure 7-3](#). [Figure 7-3](#) is taken from "Designing with Low Dropout Voltage Regulators" available from the Microchip web site ("LDO Application Hints").

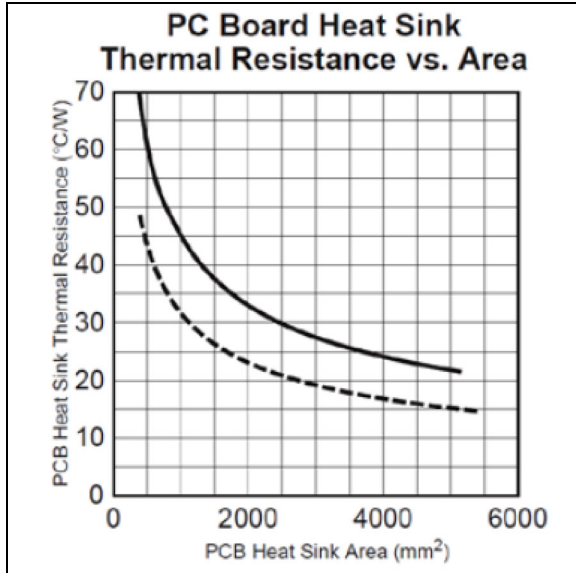

FIGURE 7-3: Graph to Determine PC Board Area for a Given PCB Thermal Resistance.

[Figure 7-3](#) shows the total area of a round or square pad, centered on the device. The solid trace represents the area of a square, single-sided, horizontal, solder-masked, copper PC board trace heat sink, measured in square millimeters. No airflow is assumed. The dashed line shows PC board's trace heat sink covered in black oil-based paint and with 1.3m/sec (250 feet per minute) airflow. This approaches a "best case" pad heat sink. Conservative design dictates using the solid trace data, which indicates a maximum pad size of 5000 mm² is needed. This is a pad that is 71 mm by 71 mm (2.8 inches per side).

8.0 PCB LAYOUT GUIDELINES

PCB layout is critical to achieve reliable, stable and efficient performance. A ground plane is required to control EMI and minimize the inductance in power and signal return paths. The following guidelines should be followed to ensure proper operation of the device:

8.1 IC (Integrated Circuit)

- Place the IC close to the point-of-load (in this case, the flash LED).
- Use fat traces to route the input and output power lines.
- Analog grounds (AGND1 and AGND2) and power grounds (PGND1 and PGND2) should be kept separate and connected at a single location.
- The exposed pad (ePAD) on the bottom of the IC must be connected to the analog ground AGND2 of the IC.
- 8 to 12 thermal vias must be placed on the PCB pad for exposed pad and connected it to the ground plane to ensure a good PCB thermal resistance can be achieved.

8.2 VIN Decoupling Capacitor

- The VIN decoupling capacitor must be placed close to the VIN pin of the IC and preferably connected directly to the pin and not through any via. The capacitor must be located right at the IC.
- The VIN decoupling capacitor should be connected to analog ground (AGND2).
- The VIN terminal is noise sensitive and the placement of capacitor is very critical.

8.3 Inductor

- Keep both the inductor connections to the switch node (SW) and input power line short and wide enough to handle the switching current. Keep the areas of the switching current loops small to minimize the EMI problem.
- Do not route any digital lines underneath or close to the inductor.
- Keep the switch node (SW) away from the noise sensitive pins.
- To minimize noise, place a ground plane underneath the inductor.

8.4 Output Capacitor

- Use wide and short traces to connect the output capacitor to the OUT and PGND1 pins.
- Place several vias to the ground plane close to the output capacitor ground terminal.
- Use either X5R or X7R temperature rating ceramic capacitors. Do not use Y5V or Z5U type ceramic capacitors.

8.5 Flash LED

- Use wide and short trace to connect the LED anode to the OUT pin.
- Use wide and short trace to connect the LED cathode to the LED pin.
- Make sure that the LED's PCB land pattern can provide sufficient PCB pad heat sink to the flash LED.

8.6 FRSET Resistor

The FRSET resistor should be placed close to the FRSET pin and connected to AGND2.

MIC2871

9.0 PACKAGING INFORMATION

9.1 Package Marking Information

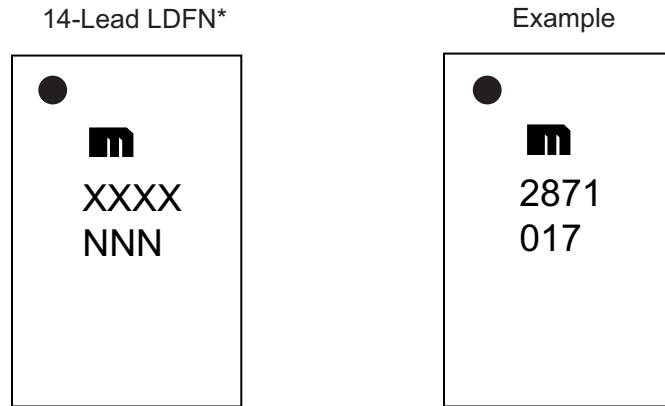

<p>Legend: XX...X Product code or customer-specific information Y Year code (last digit of calendar year) YY Year code (last 2 digits of calendar year) WW Week code (week of January 1 is week '01') NNN Alphanumeric traceability code ⓔ3 Pb-free JEDEC® designator for Matte Tin (Sn) * This package is Pb-free. The Pb-free JEDEC designator (ⓔ3) can be found on the outer packaging for this package.</p> <p>●, ▲, ▼ Pin one index is identified by a dot, delta up or delta down (triangle mark).</p>
<p>Note: In the event the full Microchip part number cannot be marked on one line, it will be carried over to the next line, thus limiting the number of available characters for customer-specific information. Package may or may not include the corporate logo.</p> <p>Underbar (¯) and/or Overbar (˘) symbol may not be to scale.</p>

9.2 Package Details

The following sections give the technical details of the packages.

TITLE

14 LEAD LDFN 3x2mm PACKAGE OUTLINE & RECOMMENDED LAND PATTERN

DRAWING #	LDFN32-14LD-PL-1	UNIT	MM
-----------	------------------	------	----

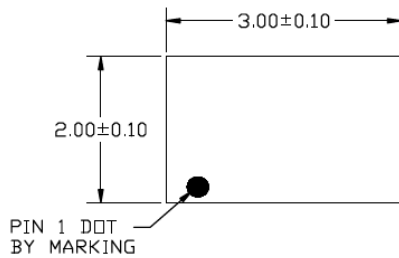

TOP VIEW

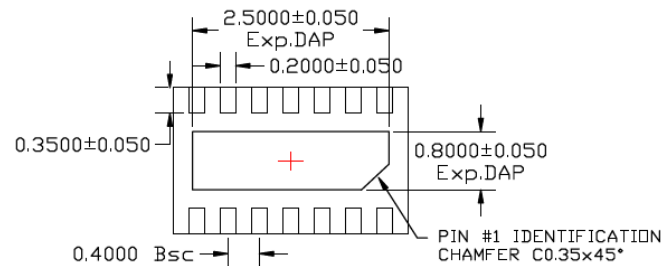

BOTTOM VIEW

NOTE 1

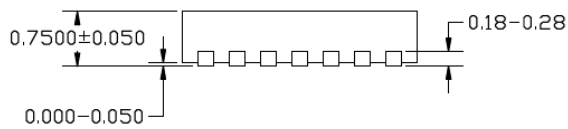

SIDE VIEW

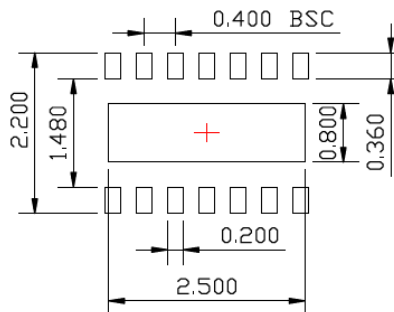

RECOMMENDED LAND PATTERN

NOTE:

1. LEADS AND EPAD CORNER MAXIMUM RADIUS 0.075MM

Note: For the most current package drawings, please see the Microchip Packaging Specification located at <http://www.microchip.com/packaging>.

MIC2871

NOTES:

APPENDIX A: REVISION HISTORY

Revision A (October 2018)

- Converted Micrel document MIC2871 to Microchip data sheet DS20006079A.
- Minor text changes throughout document.

MIC2871

NOTES:

PRODUCT IDENTIFICATION SYSTEM

To order or obtain information, e.g., on pricing or delivery, contact your local Microchip representative or sales office.

<u>PART NO.</u>		X	XX	-	XX
Device	Temperature	Package	Media Type		
Device:	MIC2871:	1.2A High-Brightness Flash LED Driver with Single-Wire Serial Interface			
Temperature:	Y =	-40°C to +125°C			
Package:	MK =	14-Pin 3 mm x 2 mm LDFN			
Media Type:	T5 =	500/Reel			
	TR =	5,000/Reel			

Examples:	
a) MIC2871YMK-T5:	MIC2871, -40°C to +125°C Temp. Range, 14-Pin LDFN, 500/Reel
b) MIC2871YMK-TR:	MIC2871, -40°C to +125°C Temp. Range, 14-Pin LDFN, 5,000/Reel

Note 1: Tape and Reel identifier only appears in the catalog part number description. This identifier is used for ordering purposes and is not printed on the device package. Check with your Microchip Sales Office for package availability with the Tape and Reel option.

MIC2871

NOTES:

Note the following details of the code protection feature on Microchip devices:

- Microchip products meet the specification contained in their particular Microchip Data Sheet.
- Microchip believes that its family of products is one of the most secure families of its kind on the market today, when used in the intended manner and under normal conditions.
- There are dishonest and possibly illegal methods used to breach the code protection feature. All of these methods, to our knowledge, require using the Microchip products in a manner outside the operating specifications contained in Microchip's Data Sheets. Most likely, the person doing so is engaged in theft of intellectual property.
- Microchip is willing to work with the customer who is concerned about the integrity of their code.
- Neither Microchip nor any other semiconductor manufacturer can guarantee the security of their code. Code protection does not mean that we are guaranteeing the product as “unbreakable.”

Code protection is constantly evolving. We at Microchip are committed to continuously improving the code protection features of our products. Attempts to break Microchip's code protection feature may be a violation of the Digital Millennium Copyright Act. If such acts allow unauthorized access to your software or other copyrighted work, you may have a right to sue for relief under that Act.

Information contained in this publication regarding device applications and the like is provided only for your convenience and may be superseded by updates. It is your responsibility to ensure that your application meets with your specifications. MICROCHIP MAKES NO REPRESENTATIONS OR WARRANTIES OF ANY KIND WHETHER EXPRESS OR IMPLIED, WRITTEN OR ORAL, STATUTORY OR OTHERWISE, RELATED TO THE INFORMATION, INCLUDING BUT NOT LIMITED TO ITS CONDITION, QUALITY, PERFORMANCE, MERCHANTABILITY OR FITNESS FOR PURPOSE. Microchip disclaims all liability arising from this information and its use. Use of Microchip devices in life support and/or safety applications is entirely at the buyer's risk, and the buyer agrees to defend, indemnify and hold harmless Microchip from any and all damages, claims, suits, or expenses resulting from such use. No licenses are conveyed, implicitly or otherwise, under any Microchip intellectual property rights unless otherwise stated.

Microchip received ISO/TS-16949:2009 certification for its worldwide headquarters, design and wafer fabrication facilities in Chandler and Tempe, Arizona; Gresham, Oregon and design centers in California and India. The Company's quality system processes and procedures are for its PIC® MCUs and dsPIC® DSCs, KEELOQ® code hopping devices, Serial EEPROMs, microperipherals, nonvolatile memory and analog products. In addition, Microchip's quality system for the design and manufacture of development systems is ISO 9001:2000 certified.

**QUALITY MANAGEMENT SYSTEM
CERTIFIED BY DNV
= ISO/TS 16949 =**

Trademarks

The Microchip name and logo, the Microchip logo, AnyRate, AVR, AVR logo, AVR Freaks, BitCloud, chipKIT, chipKIT logo, CryptoMemory, CryptoRF, dsPIC, FlashFlex, flexPWR, Helder, JukeBlox, KeeLoq, Klear, LANCheck, LINK MD, maXStylus, maXTouch, MediaLB, megaAVR, MOST, MOST logo, MPLAB, OptoLyzer, PIC, picoPower, PICSTART, PIC32 logo, Prochip Designer, QTouch, SAM-BA, SpyNIC, SST, SST Logo, SuperFlash, tinyAVR, UNI/O, and XMEGA are registered trademarks of Microchip Technology Incorporated in the U.S.A. and other countries.

ClockWorks, The Embedded Control Solutions Company, EtherSynch, Hyper Speed Control, HyperLight Load, IntellIMOS, mTouch, Precision Edge, and Quiet-Wire are registered trademarks of Microchip Technology Incorporated in the U.S.A.

Adjacent Key Suppression, AKS, Analog-for-the-Digital Age, Any Capacitor, AnyIn, AnyOut, BodyCom, CodeGuard, CryptoAuthentication, CryptoAutomotive, CryptoCompanion, CryptoController, dsPICDEM, dsPICDEM.net, Dynamic Average Matching, DAM, ECAN, EtherGREEN, In-Circuit Serial Programming, ICSP, INICnet, Inter-Chip Connectivity, JitterBlocker, KlearNet, KlearNet logo, memBrain, Mindi, MiWi, motorBench, MPASM, MPF, MPLAB Certified logo, MPLIB, MPLINK, MultiTRAK, NetDetach, Omniscient Code Generation, PICDEM, PICDEM.net, PICKit, PICtail, PowerSmart, PureSilicon, QMatrix, REAL ICE, Ripple Blocker, SAM-ICE, Serial Quad I/O, SMART-I.S., SQI, SuperSwitcher, SuperSwitcher II, Total Endurance, TSHARC, USBCheck, VariSense, ViewSpan, WiperLock, Wireless DNA, and ZENA are trademarks of Microchip Technology Incorporated in the U.S.A. and other countries.

SQTP is a service mark of Microchip Technology Incorporated in the U.S.A.

Silicon Storage Technology is a registered trademark of Microchip Technology Inc. in other countries.

GestIC is a registered trademark of Microchip Technology Germany II GmbH & Co. KG, a subsidiary of Microchip Technology Inc., in other countries.

All other trademarks mentioned herein are property of their respective companies.

© 2018, Microchip Technology Incorporated, All Rights Reserved.
ISBN: 978-1-5224-3692-8



MICROCHIP

Worldwide Sales and Service

AMERICAS

Corporate Office
2355 West Chandler Blvd.
Chandler, AZ 85224-6199
Tel: 480-792-7200
Fax: 480-792-7277
Technical Support:
<http://www.microchip.com/support>
Web Address:
www.microchip.com

Atlanta

Duluth, GA
Tel: 678-957-9614
Fax: 678-957-1455

Austin, TX

Tel: 512-257-3370

Boston

Westborough, MA
Tel: 774-760-0087
Fax: 774-760-0088

Chicago

Itasca, IL
Tel: 630-285-0071
Fax: 630-285-0075

Dallas

Addison, TX
Tel: 972-818-7423
Fax: 972-818-2924

Detroit

Novi, MI
Tel: 248-848-4000

Houston, TX

Tel: 281-894-5983

Indianapolis

Noblesville, IN
Tel: 317-773-8323
Fax: 317-773-5453
Tel: 317-536-2380

Los Angeles

Mission Viejo, CA
Tel: 949-462-9523
Fax: 949-462-9608
Tel: 951-273-7800

Raleigh, NC

Tel: 919-844-7510

New York, NY

Tel: 631-435-6000

San Jose, CA

Tel: 408-735-9110
Tel: 408-436-4270

Canada - Toronto

Tel: 905-695-1980
Fax: 905-695-2078

ASIA/PACIFIC

Australia - Sydney
Tel: 61-2-9868-6733

China - Beijing
Tel: 86-10-8569-7000

China - Chengdu
Tel: 86-28-8665-5511

China - Chongqing
Tel: 86-23-8980-9588

China - Dongguan
Tel: 86-769-8702-9880

China - Guangzhou
Tel: 86-20-8755-8029

China - Hangzhou
Tel: 86-571-8792-8115

China - Hong Kong SAR
Tel: 852-2943-5100

China - Nanjing
Tel: 86-25-8473-2460

China - Qingdao
Tel: 86-532-8502-7355

China - Shanghai
Tel: 86-21-3326-8000

China - Shenyang
Tel: 86-24-2334-2829

China - Shenzhen
Tel: 86-755-8864-2200

China - Suzhou
Tel: 86-186-6233-1526

China - Wuhan
Tel: 86-27-5980-5300

China - Xian
Tel: 86-29-8833-7252

China - Xiamen
Tel: 86-592-2388138

China - Zhuhai
Tel: 86-756-3210040

ASIA/PACIFIC

India - Bangalore
Tel: 91-80-3090-4444

India - New Delhi
Tel: 91-11-4160-8631

India - Pune
Tel: 91-20-4121-0141

Japan - Osaka
Tel: 81-6-6152-7160

Japan - Tokyo
Tel: 81-3-6880-3770

Korea - Daegu
Tel: 82-53-744-4301

Korea - Seoul
Tel: 82-2-554-7200

Malaysia - Kuala Lumpur
Tel: 60-3-7651-7906

Malaysia - Penang
Tel: 60-4-227-8870

Philippines - Manila
Tel: 63-2-634-9065

Singapore
Tel: 65-6334-8870

Taiwan - Hsin Chu
Tel: 886-3-577-8366

Taiwan - Kaohsiung
Tel: 886-7-213-7830

Taiwan - Taipei
Tel: 886-2-2508-8600

Thailand - Bangkok
Tel: 66-2-694-1351

Vietnam - Ho Chi Minh
Tel: 84-28-5448-2100

EUROPE

Austria - Wels
Tel: 43-7242-2244-39
Fax: 43-7242-2244-393

Denmark - Copenhagen
Tel: 45-4450-2828
Fax: 45-4485-2829

Finland - Espoo
Tel: 358-9-4520-820

France - Paris
Tel: 33-1-69-53-63-20
Fax: 33-1-69-30-90-79

Germany - Garching
Tel: 49-8931-9700

Germany - Haan
Tel: 49-2129-3766400

Germany - Heilbronn
Tel: 49-7131-67-3636

Germany - Karlsruhe
Tel: 49-721-625370

Germany - Munich
Tel: 49-89-627-144-0
Fax: 49-89-627-144-44

Germany - Rosenheim
Tel: 49-8031-354-560

Israel - Ra'anana
Tel: 972-9-744-7705

Italy - Milan
Tel: 39-0331-742611
Fax: 39-0331-466781

Italy - Padova
Tel: 39-049-7625286

Netherlands - Drunen
Tel: 31-416-690399
Fax: 31-416-690340

Norway - Trondheim
Tel: 47-7288-4388

Poland - Warsaw
Tel: 48-22-3325737

Romania - Bucharest
Tel: 40-21-407-87-50

Spain - Madrid
Tel: 34-91-708-08-90
Fax: 34-91-708-08-91

Sweden - Gothenberg
Tel: 46-31-704-60-40

Sweden - Stockholm
Tel: 46-8-5090-4654

UK - Wokingham
Tel: 44-118-921-5800
Fax: 44-118-921-5820