

Multi-Purpose Power Line RFI Filters for Emission Control



AMI-M12Z/M12AA/M12AB/M12AC Series
Metal Enclosure Single Phase Two Stage

AMI Designation	Input/output Style			Current Rating	Inductance	Capacitance		Resistor	Leakage Current @ 120 VAC 60Hz/250 VAC 50 Hz	TIL Insertion Loss	Case Style
						Cx	Cy				
Available Part Numbers	6.3mm Spade Terminals	Wire Leads	IEC	A	mH	nF	pF	KΩ	mA		
						AMI-M12Z-1-3-B	1				
AMI-M12Z-1-6-B	1	-	-	6	1.8	813	5500	330	0.5/0.8	002	A
AMI-M12Z-1-10-B	1	-	-	10	1.2	813	5500	330	0.5/0.8	003	A
AMI-M12Z-1-20-B	1	-	-	20	1.8	1010	5500	330	0.5/0.8	004	B
AMI-M12Z-6-20-B	-	6	-	20	1.8	1010	5500	330	0.5/0.8	004	C
AMI-M12AA-1-3-B	1	-	-	3	1.03	813	6400	330	0.5/0.8	005	B
AMI-M12AA-1-6-B	1	-	-	6	1.83	813	6400	330	0.5/0.8	006	A
AMI-M12AA-1-10-B	1	-	-	10	1.2	813	6400	330	0.5/0.8	007	A
AMI-M12AB-1-20-B	1	-	-	20	1.76	1010	6400	330	0.5/0.8	008	B
AMI-M12AB-6-20-B	-	6	-	20	1.76	1010	6400	330	0.5/0.8	008	C
AMI-M12AC-7-20-B	-	-	7	20	1.76	1010	6400	330	0.5/0.8	008	D

Multi-Purpose Power Line RFI Filters for Emission Control

Electrical Schematic

Type 1 AMI-M12Z

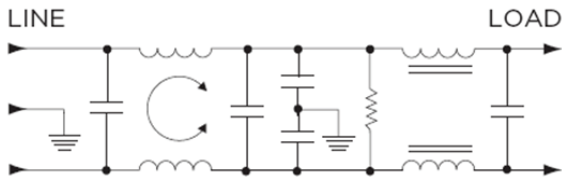

Type 2 AMI-M12AA-1-3/6/10

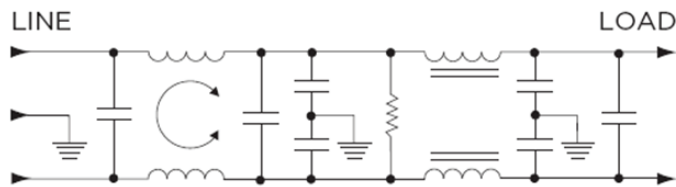

Type 3 AMI-M12AB-1/6-20

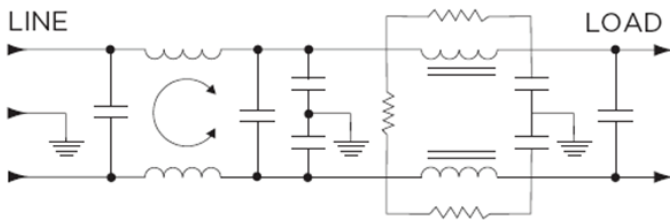

Type 4 AMI-M12AC-7-20

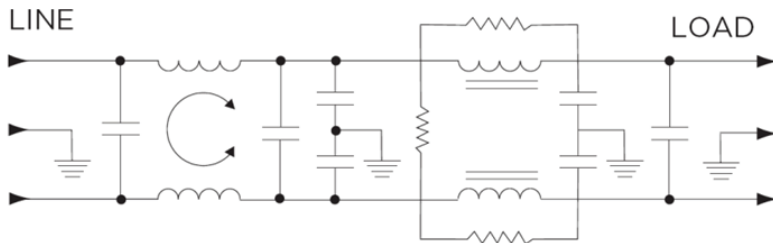

Multi-Purpose Power Line RFI Filters for Emission Control

Specifications:

- Rated Voltage (max): 250 VAC
- Operating Frequency: 50/60 Hz
- Operating Current: 3 to 20 A
- Hi-pot Rating (one minute): Line to Ground: 2250 VDC
Line to Line: 1450 VDC
- Operating Ambient Temperature Range (at rated current I_r): -10°C to +40°C. In an ambient temperature (T_a) higher than +40°C the maximum operating current (I_o) is calculated as follows: $I_o = I_r \sqrt{[(85 - T_a)/45]}$

Performance Data Typical Insertion Loss

Measured in closed 50 Ohm system

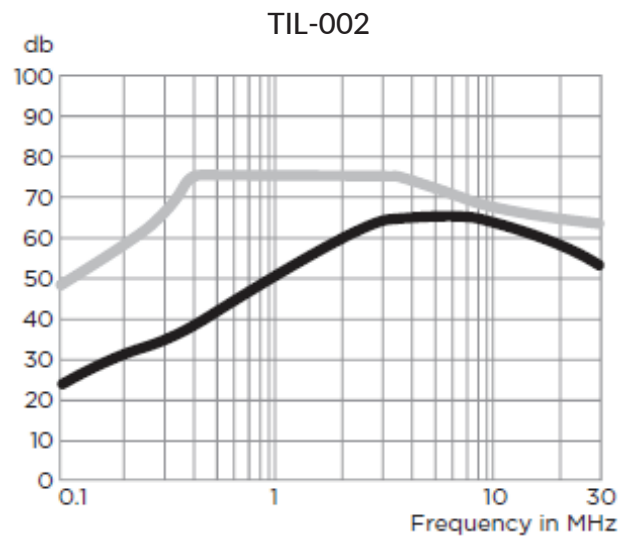
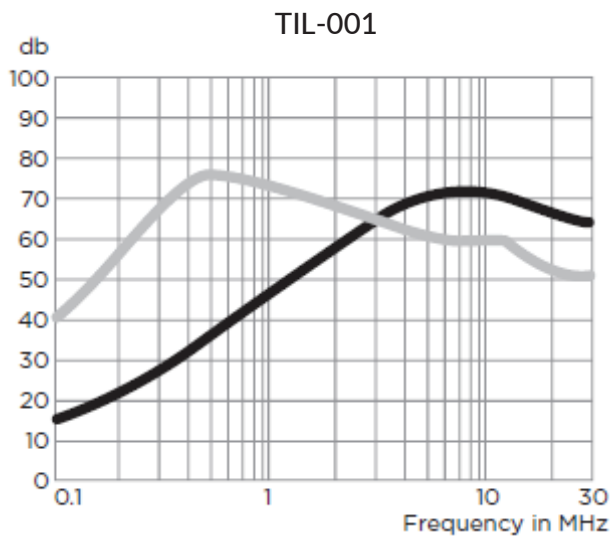

Multi-Purpose Power Line RFI Filters for Emission Control

Performance Data Typical Insertion Loss

Measured in closed 50 Ohm system

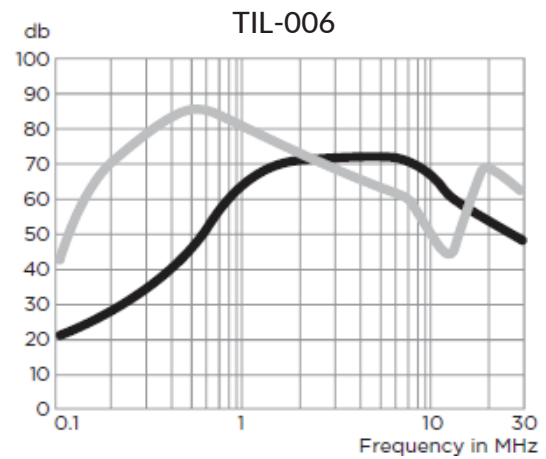
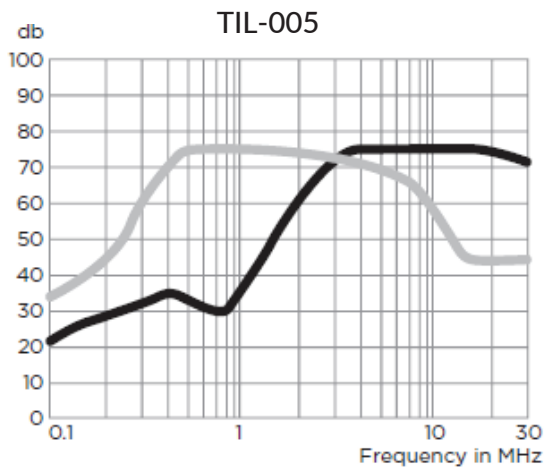
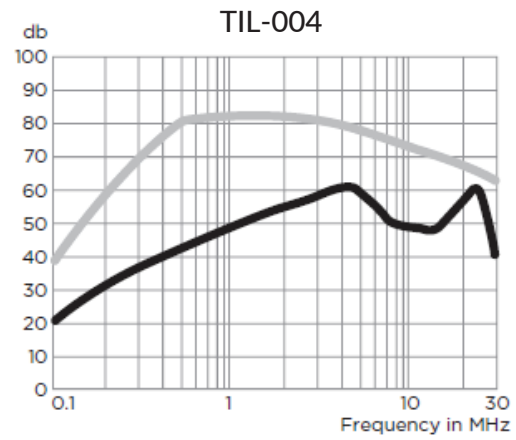
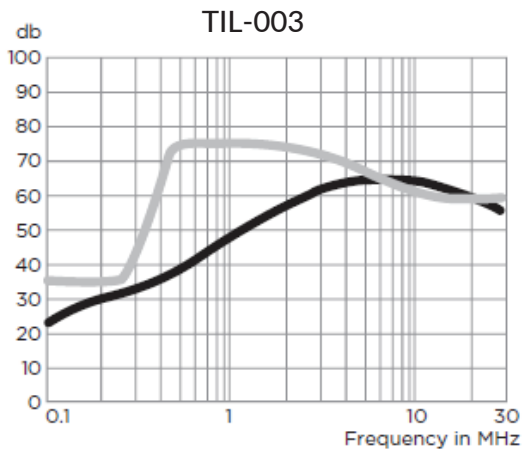

Multi-Purpose Power Line RFI Filters for Emission Control

Performance Data Typical Insertion Loss

Measured in closed 50 Ohm system

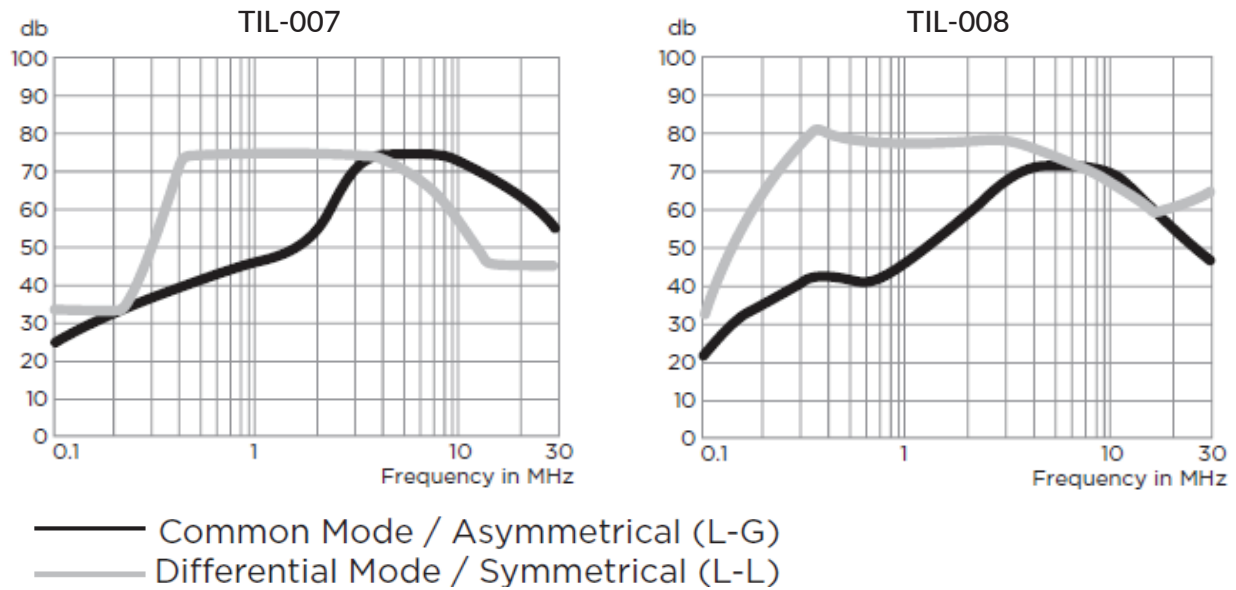

Minimum Insertion Loss

Measured in closed 50 Ohm system

Common Mode/Asymmetrical (Line to Ground)

Current Rating	Frequency-MHz							
	.15	.5	1	2	5	10	20	30
<i>AMI-M12Z-X-X-B</i>								
3A	15	27	38	47	55	55	50	48
6A	15	27	28	47	55	55	50	48
10A	15	27	38	47	55	55	50	48
20A	15	30	41	49	55	46	36	30

Multi-Purpose Power Line RFI Filters for Emission Control

Minimum Insertion Loss

Measured in closed 50 Ohm system

Common Mode/Asymmetrical (Line to Ground)

Current Rating	Frequency-MHz							
	.15	.5	1	2	5	10	20	30
<i>AMI-M12AA/AB/AC-X-X-B</i>								
3A	13	25	20	45	60	65	65	63
6A	18	30	34	40	65	65	57	47
10A	18	30	34	40	65	65	57	47
20A	18	30	34	40	65	65	57	47

Differential Mode/Symmetrical (Line to Line)

Current Rating	Frequency-MHz							
	.15	.5	1	2	5	10	20	30
<i>AMI-M12Z-X-X-B</i>								
3A	25	25	65	63	60	52	50	50
6A	40	54	65	65	65	60	57	55
10A	25	25	65	63	60	52	50	50
20A	25	25	65	63	60	52	50	50
<i>AMI-M12AA/AB/AC-X-X-B</i>								
3A	25	40	65	65	62	55	35	35
6A	30	54	65	65	60	55	38	38
10A	25	25	65	65	65	50	45	45
20A	25	25	65	65	65	50	45	45

Multi-Purpose Power Line RFI Filters for Emission Control

Case Styles

STYLE A

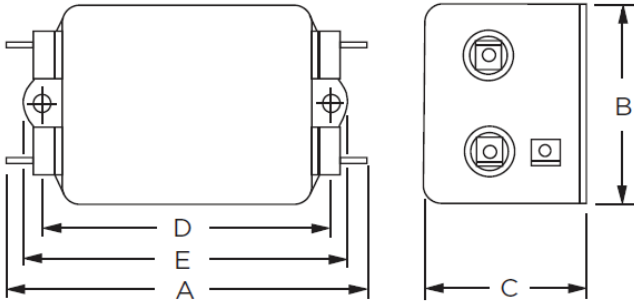

Typical Dimensions:

- Line/Load Terminals (4): .250 [6.3] with .07 [1.8] Dia. hole
- Ground Terminal (1): .250 [6.3] with .07 x .16 [1.8 x 3.8] slot
- Mounting Holes (2): .188 [4.78] Dia.

STYLE B

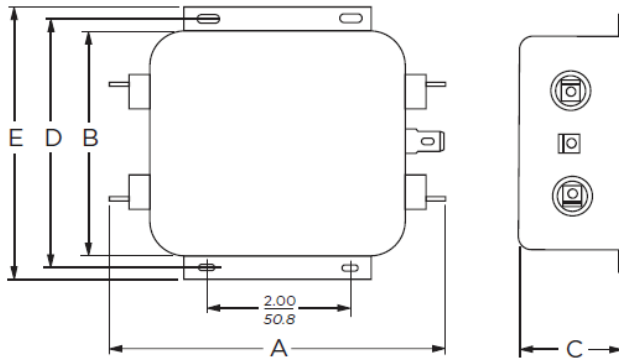

Typical Dimensions:

- Line/Load Terminals (4): .250 [6.3] with .07 [1.8] Dia. hole
- Ground Terminal (1): .250 [6.3] with .07 x .16 [1.8 x 3.8] slot
- Mounting Slots (4): .250 x .156 [6.35 x 3.96] Dia.

STYLE C

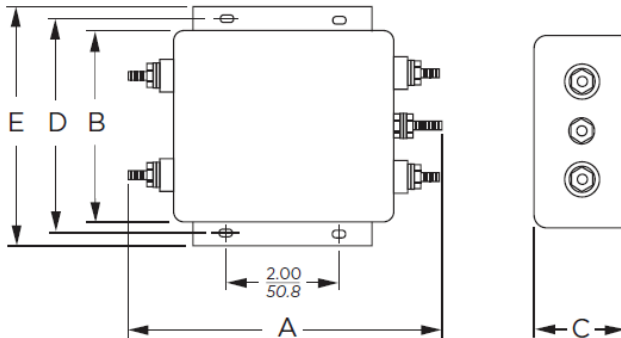

Typical Dimensions:

- Terminals (5): 8-32, Torque 18 lbf-in. [2.03 N-m] max. ± 2 [.22]
- Mounting Slots (4): .250 x .156 [6.35 x 3.96] Dia.

Multi-Purpose Power Line RFI Filters for Emission Control

Case Styles

STYLE D

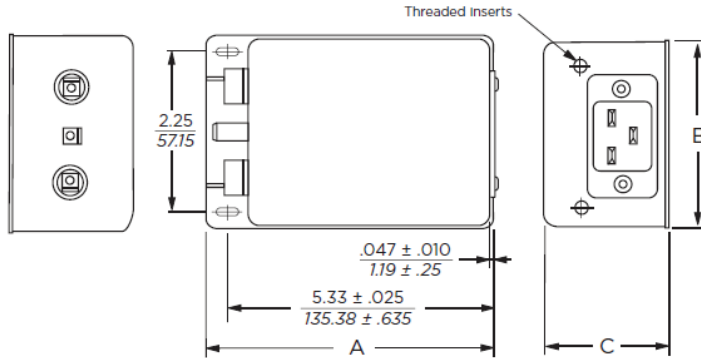

Typical Dimensions:

Load Terminals (2):	.250 [6.3] with .07 [1.8] Dia. hole
Ground Terminal (1):	.250 [6.3] with .07 x .16 [1.8 x 3.8] slot
Line Inlet (1):	IEC 60320-1 C20
Tapped Inserts (2):	6-32 x 1/4

Recommended Panel Cutout

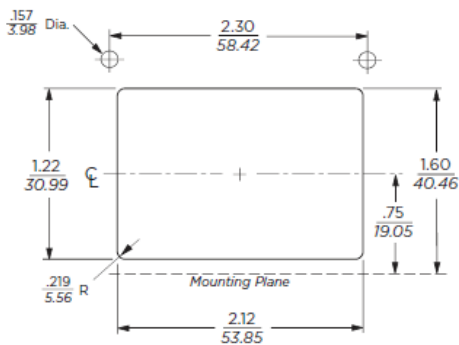

Multi-Purpose Power Line RFI Filters for Emission Control

Case Dimensions:

Model Number	A max	B max	C max	D $\begin{smallmatrix} \pm .15 \\ \pm .38 \end{smallmatrix}$	E max
AMI-M12Z-1-3 AMI-12AA-1-3	3.36"/85.3mm	1.82"/46.2mm	1.28"/32.5mm	2.375"/60.3mm	2.78"/70.6mm
AMI-M12Z-1-6 AMI-12AA-1-6	3.86"/98.0mm	2.08"/52.8mm	1.53"/38.9mm	2.938"/74.63mm	3.34"/84.8mm
AMI-M12Z-1-10 AMI-12AA-1-10	3.86"/98.0mm	2.08"/52.8mm	1.53"/38.9mm	2.938"/74.63mm	3.34"/84.8mm
AMI-M12Z-1-20 AMI-12AB-1-20	5.23"/132.8mm	3.38"/85.9mm	1.53"/38.9mm	3.75"/95.25mm	4.20"/106.7mm
AMI-M12Z-6-20 AMI-12AB-6-20	5.34"/135.6mm	3.38"/85.9mm	1.53"/38.9mm	3.75"/95.25mm	4.20"/106.7mm
AMI-M12AC-7-20	5.65"/143.51mm	3.12"/79.25mm	2.29"/58.17mm	-	-