

APPROVED: _____
 DATE: _____ TITLE: _____

Rev	AWO #	Description	Date	Appr
-		RELEASED	12/6/21	
A		ADDED DRAWING	5/27/22	WX/RC

SUGGESTED PANEL CUTOUT
 (MOUNTING FROM FRONT)

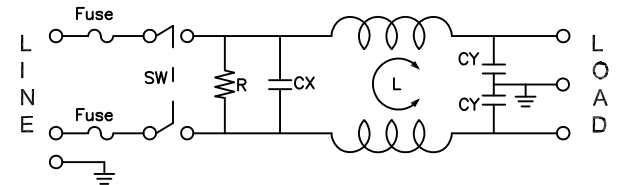
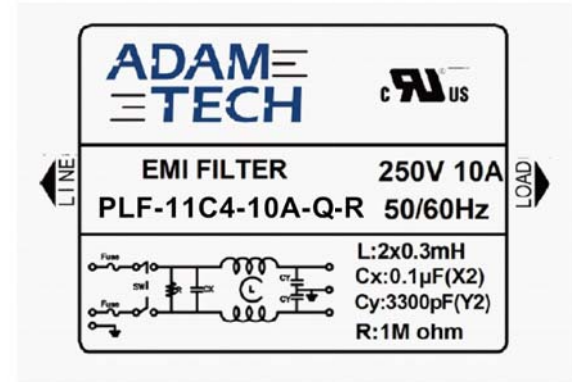
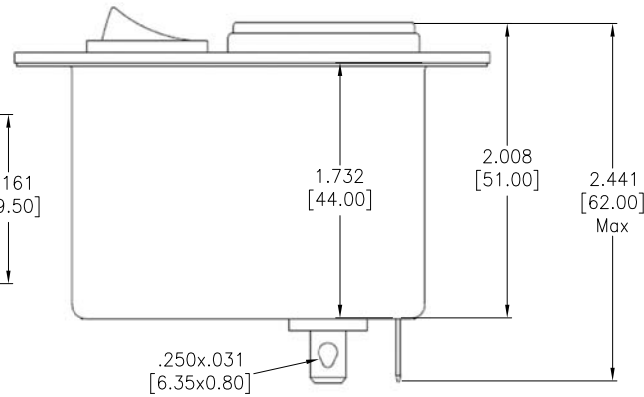
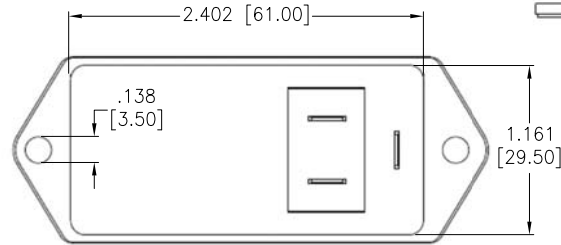
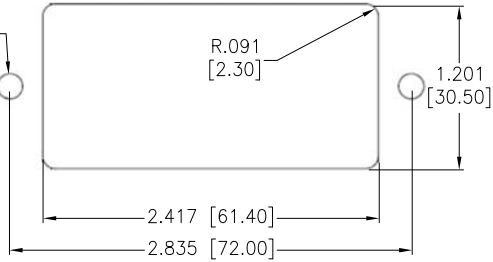
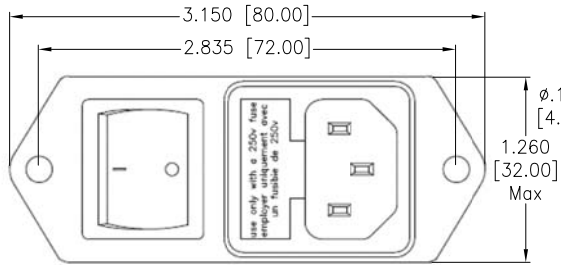

L:2x0.3mH
 Cx:0.1µF(X2)
 Cy:3300pF(Y2)*2
 R:1M ohm

SPECIFICATIONS:

Electrical:

Voltage rating: 115/250 VAC
 Current rating: 115/250 VAC: 10A RMS max
 Operating Frequency: 50/60Hz
 Leakage Current: Each Line To Ground
 @115VAC/60HZ 0.4mA max
 @250VAC/50HZ 0.8mA max

Hipot Rating(For 1 Minute)

A. Line to Ground: 2,250 VDC
 B. Line to Line: 500 VDC

IR: 50 Mohm @500 VDC Any Input or Output to Ground

Temperature Rating:
 -25°C to +100°C

Environmental:

Lead free, RoHS compliant



UNLESS OTHERWISE SPECIFIED ALL DIMENSIONS ARE INCHES [MM]. TOLERANCES: EXCEPT AS NOTED

INCHES		HOLES	
.X	± .10	Ø.X	± .10
.XX	± .020	Ø.XX	± .015
.XXX	± .015	Ø.XXX	± .010

DRAWN	JJ	12/6/21
CHECKED	RC	12/6/21
APPROVED		

THIS DRAWING CONTAINS INFORMATION THAT IS PROPRIETARY AND SHOULD NOT BE USED WITHOUT PRIOR WRITTEN PERMISSION FROM ADAM TECH



909 Rahway Avenue,
 Union, NJ 07083
 Phone: 908-687-5000
 Fax: 908-687-5710

TITLE	REV.
EMI/RF POWER FILTER FLANGED MODULE, W/FUSE AND SWITCH	A

SIZE	PART NO.	REV.
X	PLF-11C4-10A-Q-R	A

REF: S00205C SCALE: NTS SHEET 1 OF 2

6

5

4

3

2

1

APPROVED: _____

DATE: _____ TITLE: _____

Rev	AWO #	Description	Date	Appr
-----	-------	-------------	------	------

SEE SHT 1 OF 2 FOR REVISION

INSERTION LOSS(IN 50 ohm system according IEC/CISPR

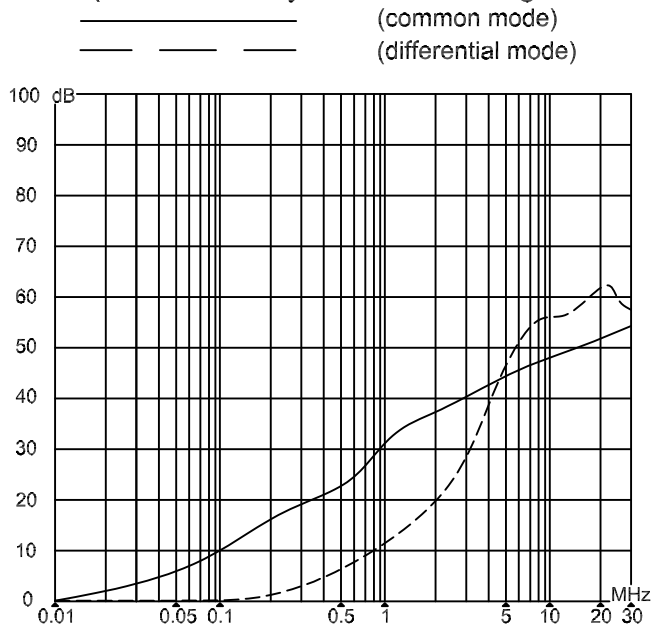

UNLESS OTHERWISE SPECIFIED ALL DIMENSIONS ARE INCHES [MM]. TOLERANCES: EXCEPT AS NOTED

INCHES	Holes
.X ± .10	ØX ± .10
.XX ± .020	ØXX ± .015
.XXX ± .015	ØXXX ± .010

DRAWN	JJ	12/6/21
CHECKED	RC	12/6/21
APPROVED		

THIS DRAWING CONTAINS INFORMATION THAT IS PROPRIETARY AND SHOULD NOT BE USED WITHOUT PRIOR WRITTEN PERMISSION FROM ADAM TECH

ADAM TECH 909 Rahway Avenue, Union, NJ 07083
Phone: 908-687-5000 Fax: 908-687-5710

TITLE	EMI/RF POWER FILTER FLANGED MODULE, W/FUSE AND SWITCH	
SIZE	PART NO.	REV.
X	PLF-11C4-10A-Q-R	A
REF:	S00205C	SCALE: NTS SHEET 2 OF 2

6

5

4

3

2

1