

RP225

HIGH PERFORMANCE DUAL STAGE POWER LINE FILTER

FEATURES

- » Rated currents include **3A, 4A, 6A, 10A, 12A and 20A**
- » Dual Stage Line Filter
- » High Performance
- » Available with **QD** tabs, **W** (wire), and **S** (studs) option
- » Agency Approved to UL1283 / 60929, CSA C22.2, EN 60939
- » Y-cap value can be adjusted to fit specification

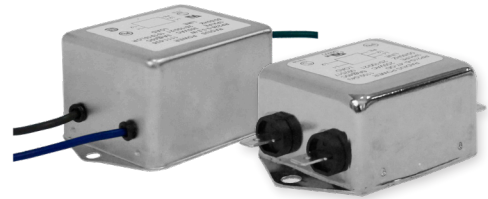

ELECTRICAL SCHEMATIC

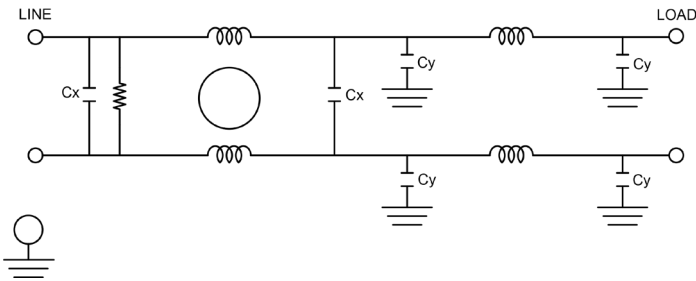

SPECIFICATIONS

OPERATING FREQUENCY	50/60Hz
USABLE FREQUENCY	DC - 400 Hz
MAX. OPERATING VOLTAGE*	250V +10%
AMBIENT TEMPERATURE	-25 TO 40°C
CLIMATIC CATEGORY	25/100/21
TERMINALS (-T)	QD: 0.25 TABS WIRE LEADS STUD (M4)

TYP. WEIGHT, LBS (KG) 0.8-1.4 (0.4-0.6)

TYPICAL LEAKAGE CURRENT

@ 250 VAC 50 Hz	0 - 1.80 mA Max.
@ 120 VAC 60 Hz	0 - 0.90 mA Max.

HIPOT RATINGS

LINE TO GROUND 2700 VDC

TYPICAL APPLICATIONS

- ✓ Automation Equipment
- ✓ Office Electronics
- ✓ Electronic Devices
- ✓ Communication Systems
- ✓ Industrial Machinery
- ✓ Power Supplies

HOW TO ORDER

RP225- X - Y - Z

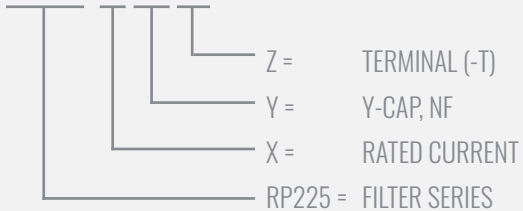

NOTE: USE ANY COMBINATION OF -X (AMPS) WITH ANY -Y RATINGS

E.G. **RP225-6-2.2-QD** (6AMP WITH 2.2 NF YCAP)

For **X, Y** and **Z** options see product specification table.

RP225

HIGH PERFORMANCE DUAL STAGE POWER LINE FILTER

MODEL NO.	RATED CURRENT, A @ 40° C	Y-CAP, nF	LEAKAGE CURRENT, mA @ 250V AC, 50 Hz / @ 120V AC, 60 Hz		TERMINAL OPTIONS			MAX. DIMENSIONS" (MM)		
					(QD) INPUT/ OUTPUT	(W) INPUT/ OUTPUT	(S) INPUT/ OUTPUT	WIDTH	(LENGTH)	HEIGHT
RP225-3-0-QD	3	0	-	-	✓			2.05" (52)	3.45" (87.72)	1.6" (41)
RP225-3-0-W	3	0	-	-		✓		4.13" (105)	4.75" (120.75)	1.61" (41)
RP225-3-.47-QD	3	0.47	0.07	0.04	✓			2.05" (52)	3.45" (87.72)	1.6" (41)
RP225-3-.47-W	3	0.47	0.07	0.04		✓		4.13" (105)	4.75" (120.75)	1.61" (41)
RP225-3-1-QD	3	1	0.15	0.09	✓			2.05" (52)	3.45" (87.72)	1.6" (41)
RP225-3-1-W	3	1	0.15	0.09		✓		4.13" (105)	4.75" (120.75)	1.61" (41)
RP225-3-2.2-QD	3	2.2	0.34	0.19	✓			2.05" (52)	3.45" (87.72)	1.6" (41)
RP225-3-2.2-W	3	2.2	0.34	0.19		✓		4.13" (105)	4.75" (120.75)	1.61" (41)
RP225-3-3.3-QD	3	3.3	0.51	0.29	✓			2.05" (52)	3.45" (87.72)	1.6" (41)
RP225-3-3.3-W	3	3.3	0.51	0.29		✓		4.13" (105)	4.75" (120.75)	1.61" (41)
RP225-3-4.7-QD	3	4.7	0.73	0.42	✓			2.05" (52)	3.45" (87.72)	1.6" (41)
RP225-3-4.7-W	3	4.7	0.73	0.42		✓		4.13" (105)	4.75" (120.75)	1.61" (41)
RP225-3-10-QD	3	10	1.57	0.90	✓			2.05" (52)	3.45" (87.72)	1.6" (41)
RP225-3-10-W	3	10	1.57	0.90		✓		4.13" (105)	4.75" (120.75)	1.61" (41)
RP225-4-0-QD	4	0	-	-	✓			2.05" (52)	3.45" (87.72)	1.6" (41)
RP225-4-0-W	4	0	-	-		✓		4.13" (105)	4.75" (120.75)	1.61" (41)
RP225-4-.47-QD	4	0.47	0.07	0.04	✓			2.05" (52)	3.45" (87.72)	1.6" (41)
RP225-4-.47-W	4	0.47	0.07	0.04		✓		4.13" (105)	4.75" (120.75)	1.61" (41)
RP225-4-1-QD	4	1	0.15	0.09	✓			2.05" (52)	3.45" (87.72)	1.6" (41)
RP225-4-1-W	4	1	0.15	0.09		✓		4.13" (105)	4.75" (120.75)	1.61" (41)
RP225-4-2.2-QD	4	2.2	0.34	0.19	✓			2.05" (52)	3.45" (87.72)	1.6" (41)
RP225-4-2.2-W	4	2.2	0.34	0.19		✓		4.13" (105)	4.75" (120.75)	1.61" (41)
RP225-4-3.3-QD	4	3.3	0.51	0.29	✓			2.05" (52)	3.45" (87.72)	1.6" (41)
RP225-4-3.3-W	4	3.3	0.51	0.29		✓		4.13" (105)	4.75" (120.75)	1.61" (41)
RP225-4-4.7-QD	4	4.7	0.73	0.42	✓			2.05" (52)	3.45" (87.72)	1.6" (41)
RP225-4-4.7-W	4	4.7	0.73	0.42		✓		4.13" (105)	4.75" (120.75)	1.61" (41)
RP225-4-10-QD	4	10	1.57	0.90	✓			2.05" (52)	3.45" (87.72)	1.6" (41)
RP225-4-10-W	4	10	1.57	0.90		✓		4.13" (105)	4.75" (120.75)	1.61" (41)
RP225-6-0-QD	6	0	-	-	✓			2.05" (52)	3.45" (87.72)	1.6" (41)
RP225-6-0-W	6	0	-	-		✓		4.13" (105)	4.75" (120.75)	1.61" (41)
RP225-6-.47-QD	6	0.47	0.07	0.04	✓			2.05" (52)	3.45" (87.72)	1.6" (41)
RP225-6-.47-W	6	0.47	0.07	0.04		✓		4.13" (105)	4.75" (120.75)	1.61" (41)
RP225-6-1-QD	6	1	0.15	0.09	✓			2.05" (52)	3.45" (87.72)	1.6" (41)
RP225-6-1-W	6	1	0.15	0.09		✓		4.13" (105)	4.75" (120.75)	1.61" (41)

ADDITIONAL MODEL NO. >>

RP225

HIGH PERFORMANCE DUAL STAGE POWER LINE FILTER

MODEL NO.	RATED CURRENT, A @ 40° C	Y-CAP, nF	LEAKAGE CURRENT, mA @ 250V AC, 50 Hz / @ 120V AC, 60 Hz		TERMINAL OPTIONS			MAX. DIMENSIONS" (MM)		
					(QD) INPUT/ OUTPUT	(W) INPUT/ OUTPUT	(S) INPUT/ OUTPUT	WIDTH	(LENGTH)	HEIGHT
RP225-6-2.2-QD	6	2.2	0.34	0.19	✓			2.05" (52)	3.45" (87.72)	1.6" (41)
RP225-6-2.2-W	6	2.2	0.34	0.19		✓		4.13" (105)	4.75" (120.75)	1.61" (41)
RP225-6-3.3-QD	6	3.3	0.51	0.29	✓			2.05" (52)	3.45" (87.72)	1.6" (41)
RP225-6-3.3-W	6	3.3	0.51	0.29		✓		4.13" (105)	4.75" (120.75)	1.61" (41)
RP225-6-4.7-QD	6	4.7	0.73	0.42	✓			2.05" (52)	3.45" (87.72)	1.6" (41)
RP225-6-4.7-W	6	4.7	0.73	0.42		✓		4.13" (105)	4.75" (120.75)	1.61" (41)
RP225-6-10-QD	6	10	1.57	0.90	✓			2.05" (52)	3.45" (87.72)	1.6" (41)
RP225-6-10-W	6	10	1.57	0.90		✓		4.13" (105)	4.75" (120.75)	1.61" (41)
RP225-10-0-QD	10	0	-	-	✓			2.05" (52)	3.45" (87.72)	1.6" (41)
RP225-10-0-W	10	0	-	-		✓		4.13" (105)	4.75" (120.75)	1.61" (41)
RP225-10-47-QD	10	0.47	0.07	0.04	✓			2.05" (52)	3.45" (87.72)	1.6" (41)
RP225-10-47-W	10	0.47	0.07	0.04		✓		4.13" (105)	4.75" (120.75)	1.61" (41)
RP225-10-1-QD	10	1	0.15	0.09	✓			2.05" (52)	3.45" (87.72)	1.6" (41)
RP225-10-1-W	10	1	0.15	0.09		✓		4.13" (105)	4.75" (120.75)	1.61" (41)
RP225-10-2.2-QD	10	2.2	0.34	0.19	✓			2.05" (52)	3.45" (87.72)	1.6" (41)
RP225-10-2.2-W	10	2.2	0.34	0.19		✓		4.13" (105)	4.75" (120.75)	1.61" (41)
RP225-10-3.3-QD	10	3.3	0.51	0.29	✓			2.05" (52)	3.45" (87.72)	1.6" (41)
RP225-10-3.3-QD	10	3.3	0.51	0.29	✓			2.05" (52)	3.45" (87.72)	1.6" (41)
RP225-10-4.7-QD	10	4.7	0.73	0.42	✓			2.05" (52)	3.45" (87.72)	1.6" (41)
RP225-10-4.7-W	10	4.7	0.73	0.42		✓		4.13" (105)	4.75" (120.75)	1.61" (41)
RP225-10-10-QD	10	10	1.57	0.90	✓			2.05" (52)	3.45" (87.72)	1.6" (41)
RP225-10-10-W	10	10	1.57	0.90		✓		4.13" (105)	4.75" (120.75)	1.61" (41)
RP225-12-0-QD	12	0	-	-	✓			2.05" (52)	3.45" (87.72)	1.6" (41)
RP225-12-0-W	12	0	-	-		✓		4.13" (105)	4.75" (120.75)	1.61" (41)
RP225-12-47-QD	12	0.47	0.07	0.04	✓			2.05" (52)	3.45" (87.72)	1.6" (41)
RP225-12-47-W	12	0.47	0.07	0.04		✓		4.13" (105)	4.75" (120.75)	1.61" (41)
RP225-12-1-QD	12	1	0.15	0.09	✓			2.05" (52)	3.45" (87.72)	1.6" (41)
RP225-12-1-W	12	1	0.15	0.09		✓		4.13" (105)	4.75" (120.75)	1.61" (41)
RP225-12-2.2-QD	12	2.2	0.34	0.19	✓			2.05" (52)	3.45" (87.72)	1.6" (41)
RP225-12-2.2-W	12	2.2	0.34	0.19		✓		4.13" (105)	4.75" (120.75)	1.61" (41)
RP225-12-3.3-QD	12	3.3	0.51	0.29	✓			2.05" (52)	3.45" (87.72)	1.6" (41)
RP225-12-3.3-W	12	3.3	0.51	0.29		✓		4.13" (105)	4.75" (120.75)	1.61" (41)
RP225-12-4.7-QD	12	4.7	0.73	0.42	✓			2.05" (52)	3.45" (87.72)	1.6" (41)
RP225-12-4.7-W	12	4.7	0.73	0.42		✓		4.13" (105)	4.75" (120.75)	1.61" (41)

ADDITIONAL MODEL NO. >>

RP225

HIGH PERFORMANCE DUAL STAGE POWER LINE FILTER

MODEL NO.	RATED CURRENT, A @ 40° C	Y-CAP, nF	LEAKAGE CURRENT, mA @ 250V AC, 50 Hz / @ 120V AC, 60 Hz		TERMINAL OPTIONS			MAX. DIMENSIONS" (MM)		
					(QD) INPUT/ OUTPUT	(W) INPUT/ OUTPUT	(S) INPUT/ OUTPUT	WIDTH	(LENGTH)	HEIGHT
RP225-12-10-QD	12	10	1.57	0.90	✓			2.05" (52)	3.45" (87.72)	1.6" (41)
RP225-12-10-W	12	10	1.57	0.90		✓		4.13" (105)	4.75" (120.75)	1.61" (41)
RP225-20-0-QD	20	0	-	-	✓			4.13" (105)	4.75" (120.75)	1.54" (39)
RP225-20-0-S	20	0	-	-			✓	4.13" (105)	5.33" (135.5)	1.54" (39)
RP225-20-0-W	20	0	-	-		✓		*	*	*
RP225-20-47-QD	20	0.47	0.07	0.04	✓			4.13" (105)	4.75" (120.75)	1.54" (39)
RP225-20-47-S	20	0.47	0.07	0.04			✓	4.13" (105)	5.33" (135.5)	1.54" (39)
RP225-20-47-W	20	0.47	0.07	0.04		✓		*	*	*
RP225-20-1-QD	20	1	0.15	0.09	✓			4.13" (105)	4.75" (120.75)	1.54" (39)
RP225-20-1-S	20	1	0.15	0.09			✓	4.13" (105)	5.33" (135.5)	1.54" (39)
RP225-20-1-W	20	1	0.15	0.09		✓		*	*	*
RP225-20-2.2-QD	20	2.2	0.34	0.19	✓			4.13" (105)	4.75" (120.75)	1.54" (39)
RP225-20-2.2-S	20	2.2	0.34	0.19			✓	4.13" (105)	5.33" (135.5)	1.54" (39)
RP225-20-2.2-W	20	2.2	0.34	0.19		✓		*	*	*
RP225-20-3.3-QD	20	3.3	0.51	0.29	✓			4.13" (105)	4.75" (120.75)	1.54" (39)
RP225-20-3.3-S	20	3.3	0.51	0.29			✓	4.13" (105)	5.33" (135.5)	1.54" (39)
RP225-20-3.3-W	20	3.3	0.51	0.29		✓		*	*	*
RP225-20-4.7-QD	20	4.7	0.73	0.42	✓			4.13" (105)	4.75" (120.75)	1.54" (39)
RP225-20-4.7-S	20	4.7	0.73	0.42			✓	4.13" (105)	5.33" (135.5)	1.54" (39)
RP225-20-4.7-W	20	4.7	0.73	0.42		✓		*	*	*
RP225-20-10-QD	20	10	1.57	0.90	✓			4.13" (105)	4.75" (120.75)	1.54" (39)
RP225-20-10-S	20	10	1.57	0.90			✓	4.13" (105)	5.33" (135.5)	1.54" (39)
RP225-20-10-W	20	10	1.57	0.90		✓		*	*	*

*Contact factory for dimensions.

RP225

HIGH PERFORMANCE DUAL STAGE POWER LINE FILTER

RP225 MECHANICAL OUTLINES (MM)

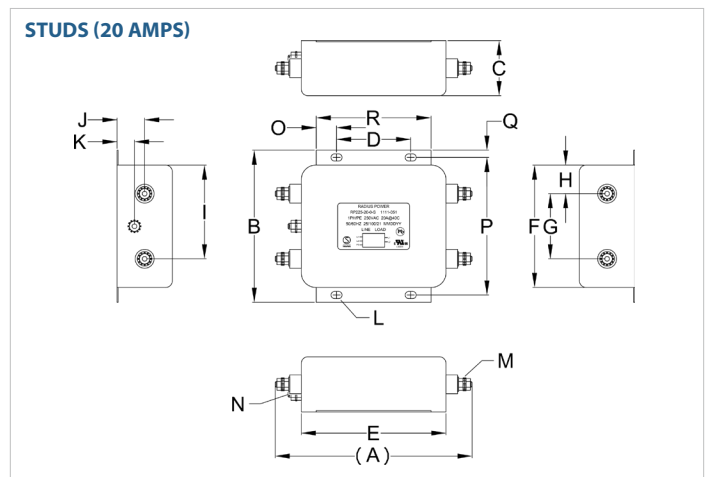
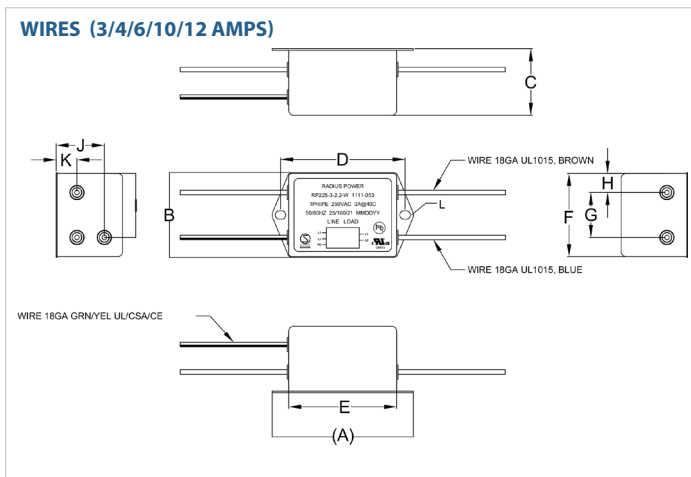
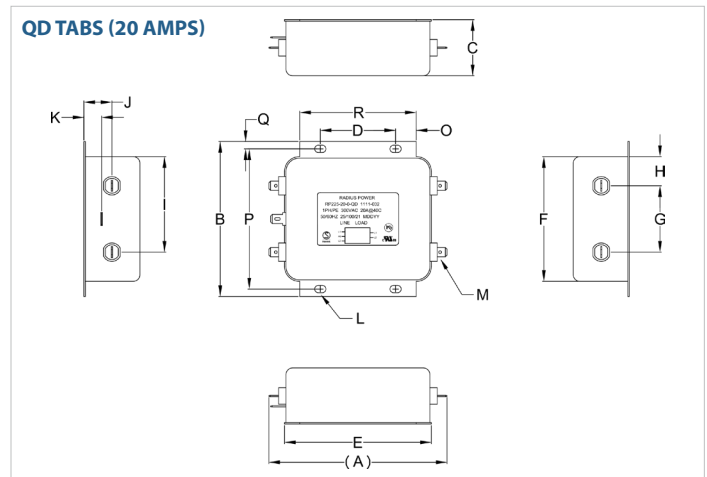
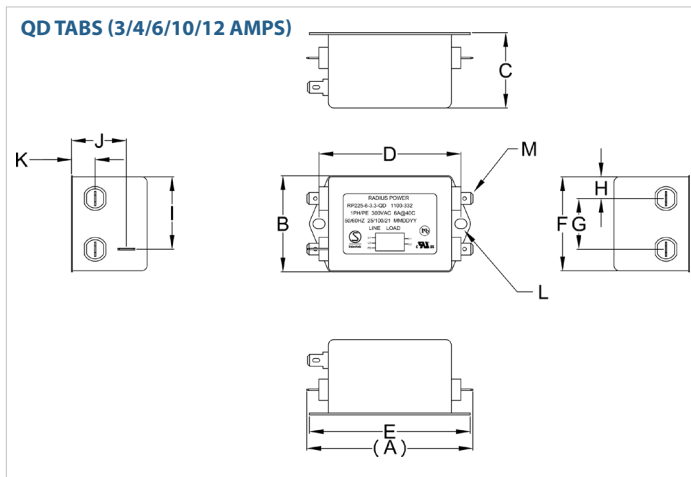

SERIES	(A)	B	C	D	E	F	G	H	I	J	K	L	M	N	O	P	Q	R
QD TABS (3-12 A)	3.45" (87.72)	2.05" (52)	1.6" (41)	2.95" (75)	3.35" (85)	1.97" (50)	1.06" (27)	0.45" (11.5)	1.52" (38.5)	1.14" (29)	0.49" (12.5)	Ø 0.25"x5.1, 2x Ø 6.4x5.1, 2x	0.25", 5x QD, MALE, 6.35, 5x	N/A	0.55" (14)	3.74" (95)	0.20" (5)	3.11" (79)
QD TABS (20 A)	4.75" (120.75)	4.13" (105)	1.54" (39)	2.01" (51)	3.92" (99.5)	3.37" (85.5)	1.77" (45)	0.78" (19.75)	2.55" (64.75)	0.75" (19)	0.47" (12)	Ø 0.29x5, 4x Ø 7.6x5, 4x	0.25", 5x QD, MALE, 6.35, 5x	N/A	0.55" (14)	3.74" (95)	0.20" (5)	3.11" (79)
WIRES (3-12A)	3.35" (85)	2.05" (52)	1.61" (41)	2.95" (75)	2.60" (66)	2.01" (51)	1.06" (27)	0.45" (11.5)	1.52" (38.5)	1.14" (29)	0.49" (12.5)	Ø 0.25"x5.1, 2x Ø 6.4x5.1, 2x	N/A	N/A	N/A	N/A	N/A	N/A
STUDS	5.33" (135.5)	4.13" (105)	1.54" (39)	2.01" (51)	3.76" (95.5)	3.37" (85.5)	1.77" (45)	0.78" (19.75)	2.55" (64.75)	0.75" (19)	0.47" (12)	Ø 0.29x5.0, 4x Ø 7.6x5.0, 4x	STUD, M4, 4x	STUD, GND, M4	N/A	N/A	N/A	N/A

TYPICAL TOLERANCE: +/-0.02" (0.50MM)

RP225

HIGH PERFORMANCE DUAL STAGE POWER LINE FILTER

TYPICAL INSERTION LOSS, dB (50/50 Ohm)

Amps	Freq (MHz)	0.15	0.5	1.0	10	30
3	CM (dB)	14	28	30	65	65
	DM (dB)	26	65	65	55	36
4	CM (dB)	48	50	50	45	45
	DM (dB)	65	75	75	65	60
6	CM (dB)	19	32	36	65	50
	DM (dB)	30	65	65	52	45
10	CM (dB)	20	30	34	65	50
	DM (dB)	26	65	65	52	45
12	CM (dB)	22	35	40	65	50
	DM (dB)	33	65	65	55	40
20	CM (dB)	20	32	65	65	50
	DM (dB)	26	65	65	50	45