

# Metal Enclosure 3 Phase Single Stage

## AMI-M31NA Series

Multipurpose Power Line RFI Filters for Emission Control



AMI Designation	Input/output Style		Current Rating	Inductance mH	Capacitance		Resistor KΩ	Leakage Current @ 120 VAC 60Hz/250 VAC 50Hz	TIL Insertion Loss	Case Style
			A		Cx nF	Cy pF				
<b>Available Part Numbers</b>	<b>6.3mm Spades Terminals</b>	<b>Wire Leads</b>								
AMI-M31NA-6A-16-D (1.2*4400*30000*330)	6	-	16	1.2	4400	30000	330	1.62/2.82	001	A
AMI-M31NA-6A-25-D (1.1*4400*30000*330)	6	-	25	1.1	4400	30000	330	1.62/2.82	002	A
AMI-M31NA-6A-36-D (0.88*4400*30000*330)	6	-	36	0.88	4400	30000	330	1.62/2.82	003	A
AMI-M31NA-6A-50-D (0.67*4400*30000*330)	6	-	50	0.67	4400	30000	330	1.62/2.82	004	A
AMI-M31NA-6A-100-D (0.25*4400*30000*330)	6	-	100	0.25	4400	30000	330	1.62/2.82	006	A
AMI-M31NA-6-36-D (0.88*4400*30000*330)	6	-	36	0.88	4400	30000	330	1.62/2.82	003	B
AMI-M31NA-6-50-D (0.67*4400*30000*330)	6	-	50	0.67	4400	30000	330	1.62/2.82	004	B

\*(A)-Flange Mount

## Electrical Schematic

AMI-M31NA

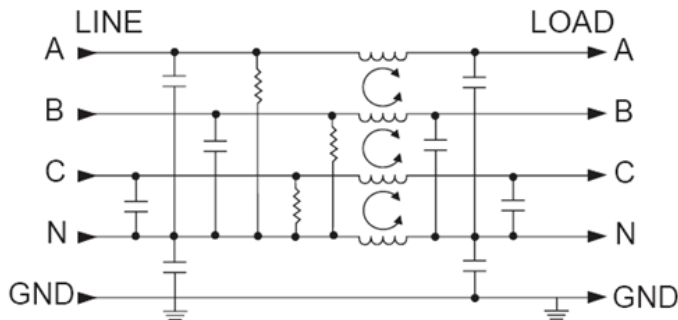

# Metal Enclosure 3 Phase Single Stage

## SPECIFICATIONS:

- Rated Voltage (max): Phase to Phase: 440 VAC  
Phase to Neutral/Ground: 250 VAC
- Operating Frequency: 50/60 Hz
- Operating Current: 16 to 100A
- Hi-pot Rating (one minute): Line to Ground: 1500 VAC  
Line to Line: 1450 VDC
- Operating Ambient Temperature Range (at rated current  $I_r$ ): -10°C to +40°C. In an ambient temperature ( $T_a$ ) higher than +40°C the maximum operating current ( $I_o$ ) is calculated as follows:  $I_o = I_r \sqrt{[(85 - T_a)/45]}$

## Performance Data Typical Insertion Loss

Measured in closed 50 Ohm system

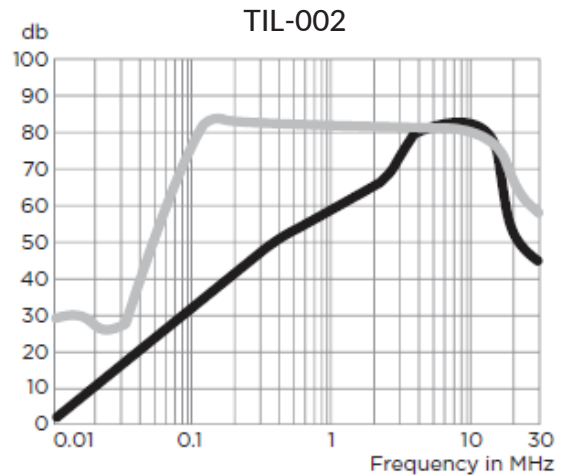
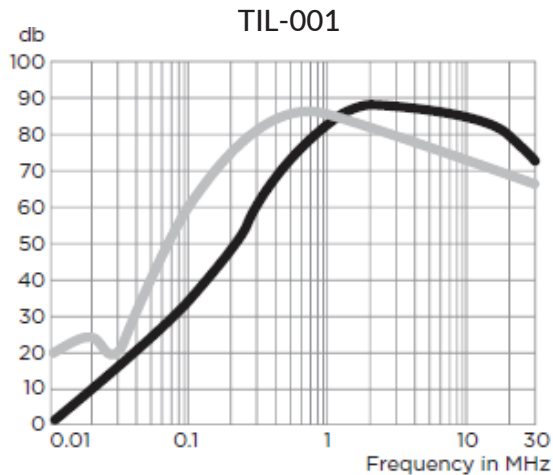

# Metal Enclosure 3 Phase Single Stage

## Performance Data Typical Insertion Loss

Measured in closed 50 Ohm system

TIL-003

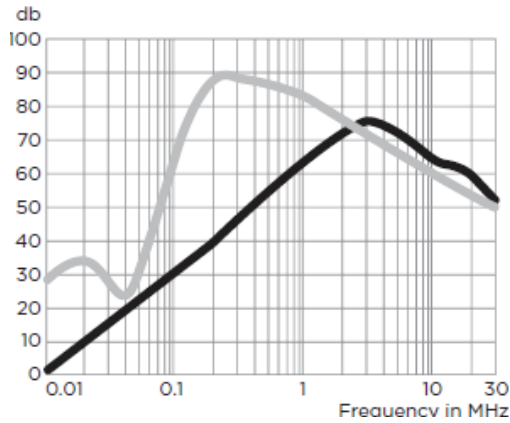

TIL-004

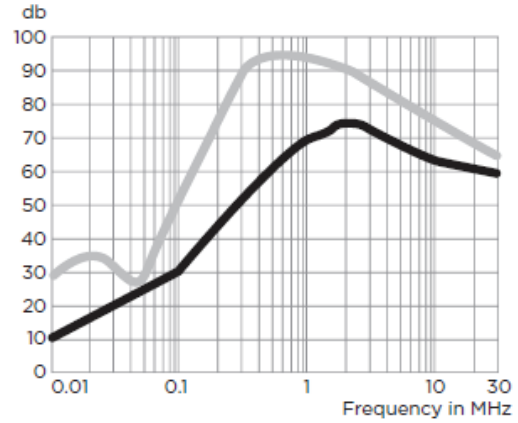

TIL-005

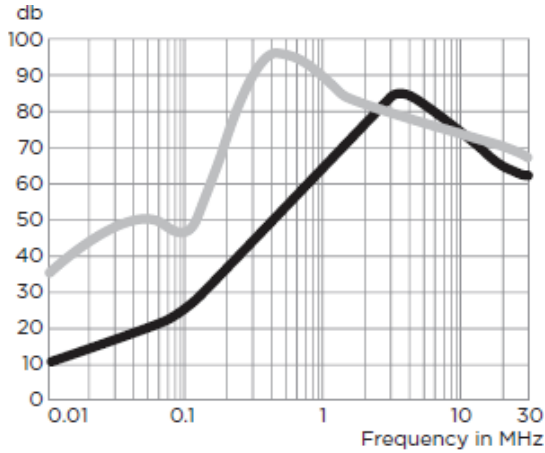

TIL-006

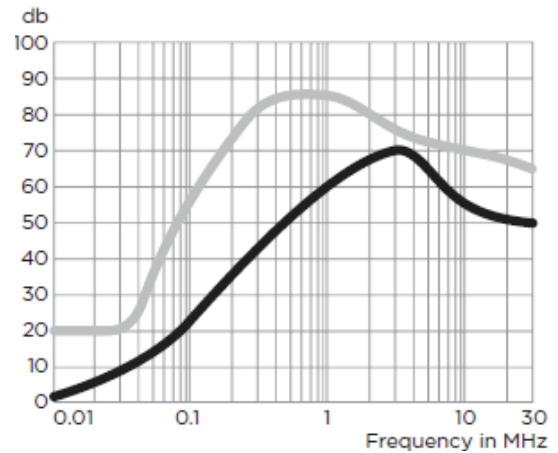

# Metal Enclosure 3 Phase Single Stage

## Minimum Insertion Loss

Common Mode/Asymmetrical (Line to Ground)

Current Rating	Frequency-MHz							
	.01	.05	.1	.5	1	5	10	30
16A	2	11	19	52	53	70	61	30
25A	2	12	19	46	49	64	54	27
36A	1	10	18	49	54	63	57	32
50A	1	8	14	43	47	63	53	29
63A	2	10	22	50	60	75	70	55
100A	1	15	22	55	60	65	55	50

Differential Mode/Symmetrical (Line to Line)

Current Rating	Frequency-MHz							
	.01	.05	.1	.5	1	5	10	30
16A	14	31	30	82	87	76	77	47
25A	20	36	38	85	81	68	69	33
36A	20	39	36	86	78	65	62	35
50A	20	30	38	85	82	67	66	38
63A	30	40	45	90	85	70	70	60
100A	20	35	45	80	80	65	60	55

# Metal Enclosure

## 3 Phase Single Stage

### Case Styles

#### STYLE A

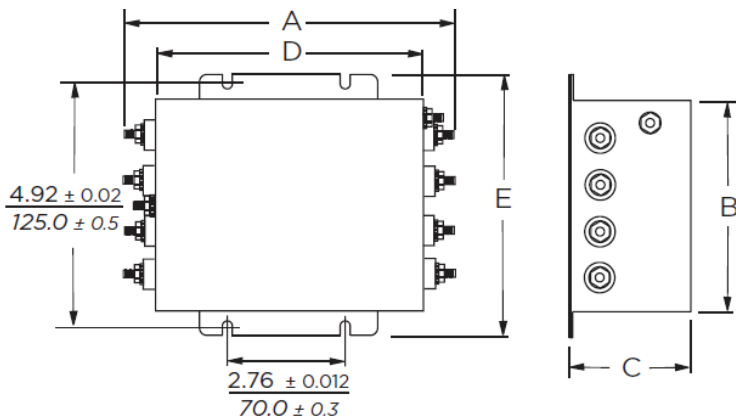

#### Typical Dimensions:

Mounting slots (4):	.425 x .254 [10.8 x 6.6]
16 & 25A Terminals(8):	8-32, Torque (max.) 26 lbf-in [2.94 N-m]
36A Terminals(8):	10-32, Torque (max.) 27 lbf-in [3.05 N-m]
50, 63 & 100A Terminals(8):	1/4-20, Torque (max.) 56 lbf-in [6.33 N-m]

#### STYLE B

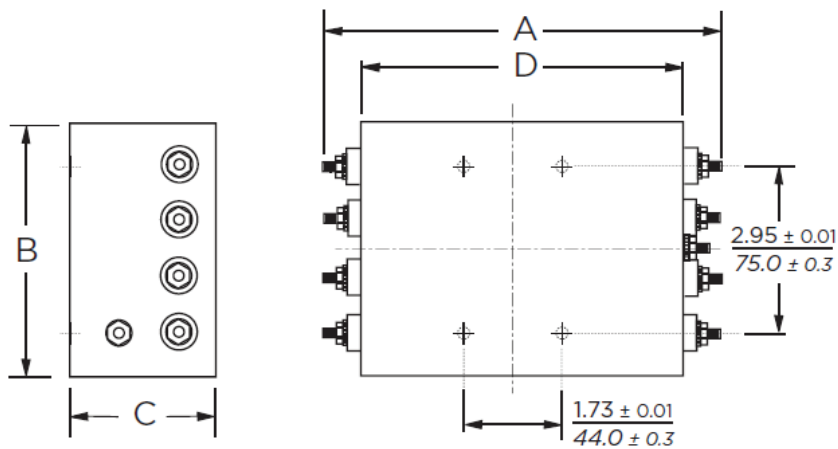

#### Typical Dimensions:

Threaded mounting holes(4):	M5 x 8
16 & 25A Terminals(8):	8-32, Torque (max.) 26 lbf-in [2.94 N-m]
36A Terminals(8):	10-32, Torque (max.) 27 lbf-in [3.05 N-m]
50A Terminals(8):	1/4-20, Torque (max.) 56 lbf-in [6.33 N-m]

# Metal Enclosure 3 Phase Single Stage

## Case Dimensions:

Model Number	A max	B max	C max	D $\begin{smallmatrix} \pm .015 \\ \pm .38 \end{smallmatrix}$	E max
AMI-M31NA-6-16/25	7.91"/201.mm	4.37"/111.0mm	1.97"/50.0mm	5.94"/151.0mm	5.51"/140.0mm
AMI-M31NA-6-36/50	7.91"/201.mm	4.37"/111.0mm	2.56"/65.0mm	5.94"/151.0mm	5.51"/140.0mm
AMI-M31NA-6-100	7.91"/201.mm	4.37"/111.0mm	2.56"/65.0mm	5.94"/151.0mm	5.51"/140.0mm
AMI-M31NA-6A-36/50	7.91"/201.mm	4.37"/111.0mm	2.56"/65.0mm	5.94"/151.0mm	-