

Filters for Communication Lines

ISDN Systems

Series/Type: **B84312**

Date: January 2004

© EPCOS AG 2015. Reproduction, publication and dissemination of this publication, enclosures hereto and the information contained therein without EPCOS' prior express consent is prohibited.

EPCOS AG is a TDK Group Company.

**For ISDN-Interfaces S_0 , S_2 , U_{P0}
and U_2 plus Siemens Hicom installations
Stopband attenuation up to 40 GHz**

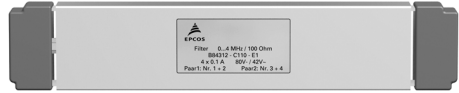

Features

- Use of coaxial feed-through capacitors on input and output
- Single or current-balanced chokes depending on requirement
- Insertion loss to CISPR 17

Installation

Single filters are attached straight to the shielding wall. Larger numbers can be housed in filter cabinets or boxes. Various models and the matching flexible connector fittings are available.

Overview of ISDN systems and suitable filters

System	Standard	Number of pairs	Transmission rate	Focal frequency f_{test}	Filter band width ($5 \times f_{\text{test}}$)	Z_L Ω	Filter (Ordering code)
S_2 and/or PCM 30	CCITT, G.703	2	2.048 Mbit/s	1.024 MHz	5.12 MHz	120	B84312C0112E001
S_0 ISDN, 2B+D	CCITT, I.430 ETS300012	2	144 kbit/s	96 kHz	480 kHz	85... 160	B84312C0110E001
U_{P0} ISDN, 2B+D	ZVEI	1	304 kbit/s (152 kbit/s in each direction)	192 kHz	960 kHz	100	B84312C0114B001
U_{2B1Q} ISDN, 2B+D	ANSI T1.601-1988	1	160 kbit/s	40 kHz	200 kHz	135	B84312C0060B001
U_{K0} ISDN, 2B+D	FTZ 1 TR 220	1	160 kbit/s	60 kHz	300 kHz	150	B84312C0060B001
U_{200} 1B+D	Interface for Siemens Hicom	1	160 kbit/s (80 kbit/s in each direction)	128 kHz	640 kHz	130	B84312C0114B001

ISDN systems
General technical data

Rated voltage	$V_{R,AC}$	42 and 100	V	
Rated voltage	$V_{R,DC}$	80 and 100	V	
Rated frequency	f_R	See characteristics		Pass bandwidth at Z_L
Rated current	I_R	100	mA	Referred to +40 °C ambient temperature
Line impedance	Z_L	See characteristics		
Test voltage	V_{rest}	250 VDC, 2 s 250 VDC, 2 s		Line/line Line/case
Maximum DC resistance	R_{max}	See characteristics		Per line
Permissible ambient temperature	T_A	-25/+40	°C	
Climatic category (EN 60068-1)		25/085/56		-25 °C/+85 °C/56 days damp heat test
Approx. weight		560	g	

Characteristics and ordering codes

$V_{R,AC}$	$V_{R,DC}$	f_R	Z_L	R_{max}	Number of pairs	Ordering code
V	V	MHz	Ω	Ω		
100	100	0 ... 0.3	150	2	1	B84312C0060B001
42	80	0 ... 4	100	4.2	1	B84312C0114B001
42	80	0 ... 4	100	4.2	2	B84312C0110E001
42	80	0 ... 10	50	1	2	B84312C0112E001

Insertion loss α_e in passband (typical)

B84312C0060B001

Measurement circuit

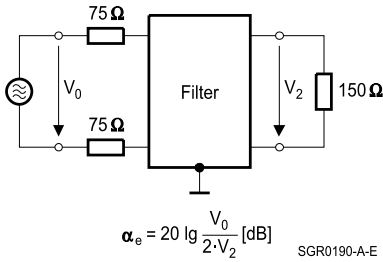

Symmetrical measurement circuit
with $Z_L = 150 \Omega$

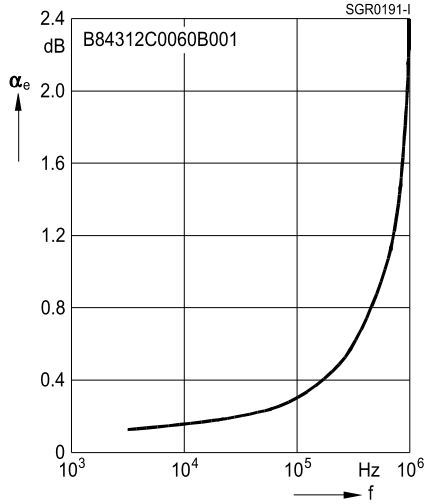

B84312C0110E001, ...C0114B001

Measurement circuit

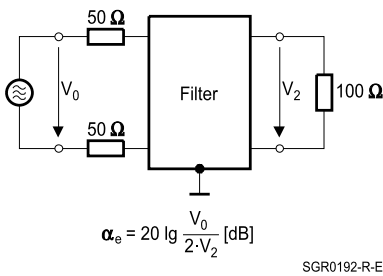

Symmetrical measurement circuit
with $Z_L = 100 \Omega$

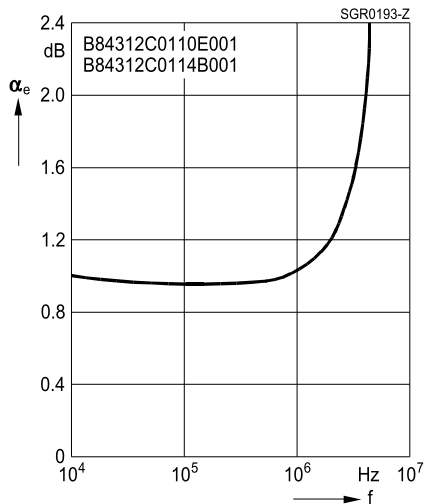

B84312C0112E001

Measurement circuit

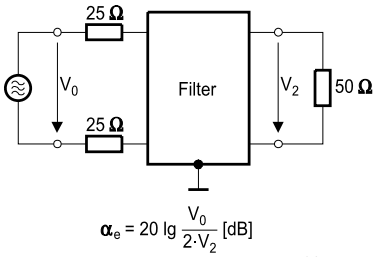

SGR0194-8-E

Symmetrical measurement circuit
with $Z_L = 50 \Omega$

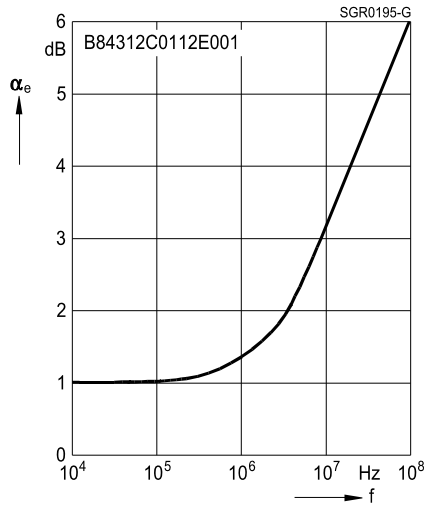

Insertion loss α_e in stopband (typical)

Measurement circuit

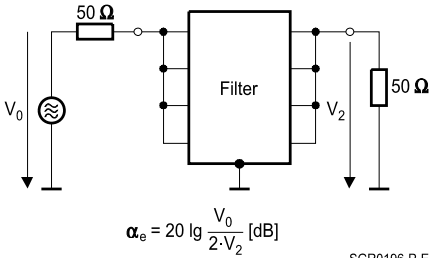

Asymmetrical measurement circuit
to MIL-STD-220A

B84312C0060B001

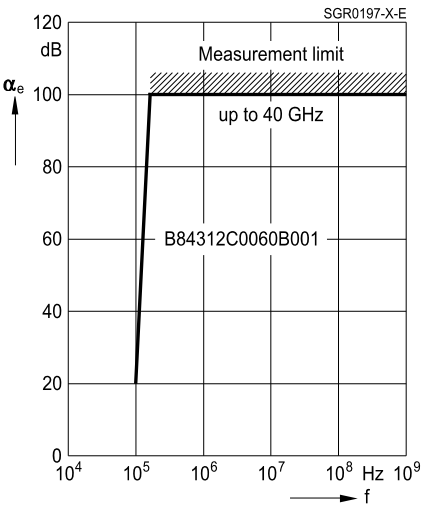

B84312C0110E001, ...C0114B001

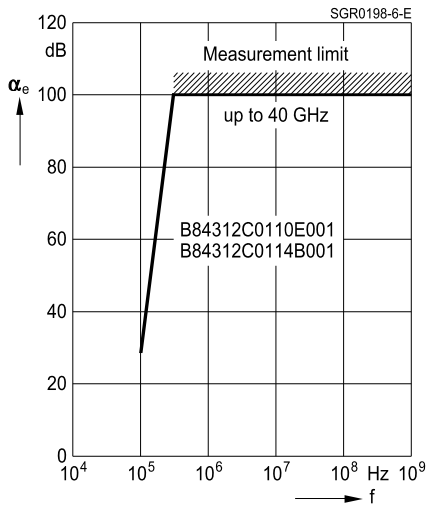

B84312C0112E001

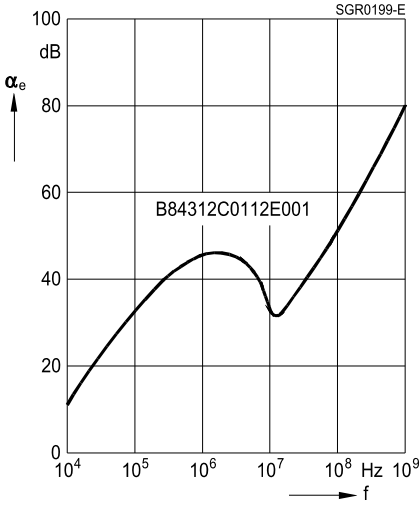

Signal characteristic to CCITT G.703
for filter B84312C0112E001

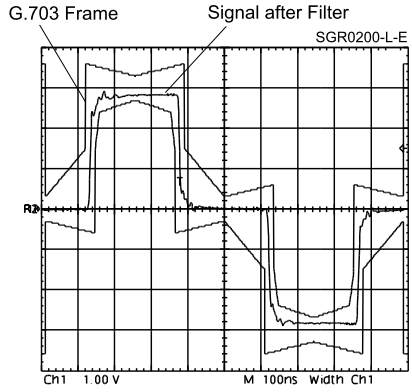

Dimensional drawing

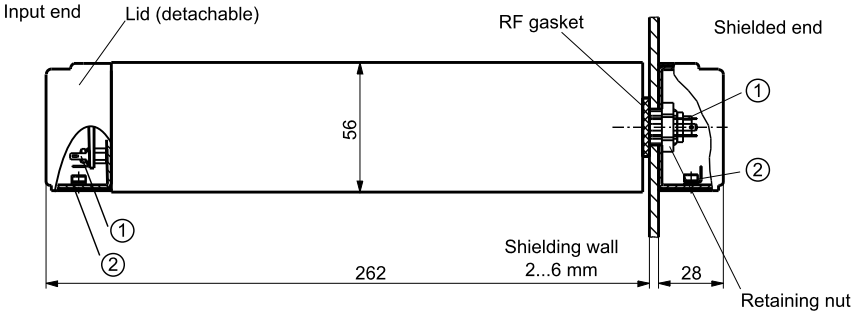

Plan view

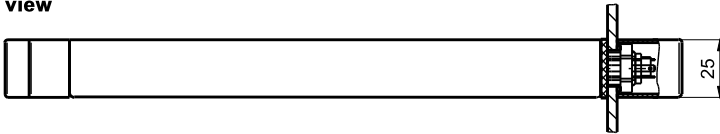

SGR0201-U-E

- ① Line connection at both ends:
2 x tab connectors for receptacle 2.8 x 0.5 (in accessory bag)
- ② Strain relief with ground connection for cable diameter 4.5 ... 6 mm

Hole for installation in shielding wall

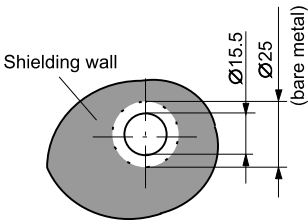

SGR0185-9-E