

Power line filters for three-phase systems
Rated voltage 440/250 V~, 50/60 Hz
Rated current 6 to 25 A

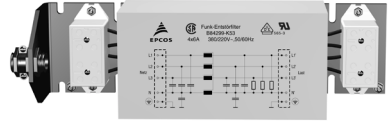

Construction

- Four-line filter
- Plastic case

Features

- High insertion loss

Applications

- Power supplies for
 - industrial installations
 - knitting machines
 - data systems
 - medical equipment

Terminals

- Safe-to-touch terminal blocks

Marking

Marking on component:

Manufacturer's logo, ordering code,
 rated voltage, rated current, date code

Minimum marking on packaging:

Manufacturer's logo, ordering code

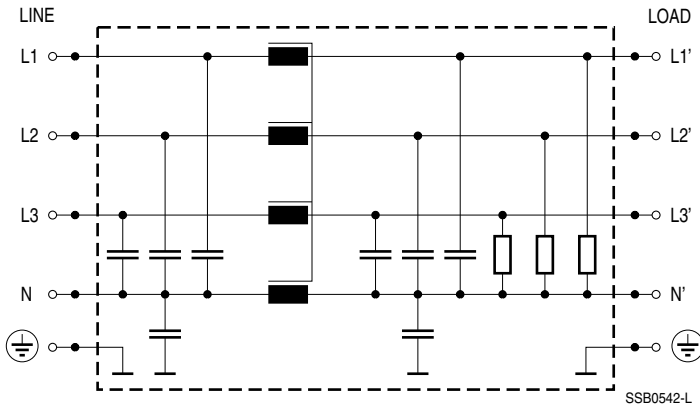

Circuit diagram



Technical data

Rated voltage V_R	440/250 V~, 50/60 Hz
Rated current I_R	referred to 40 °C ambient temperature
Test voltage V_P	1414 V~, 2 s (line/line) 2700 V~, 2 s (lines/case)
Leakage current I_{leak}	< 3,5 mA at 400 V~, 50 Hz
Climatic category	in accordance with EN 60068-1 25/085/21 (- 25 °C/+ 85 °C/21 days damp heat test)

Characteristics and ordering codes

I_R	Dim. h mm	Dim. L mm	Cable fitting for cable diameter	Approx. weight kg	Ordering code	Approvals		
								
6	50	14,5	8 ... 12,5 mm	1,1	B84299-K53	×	—	—
16	67	10,5	7 ... 15,0 mm	1,6	B84299-K55	×	—	—
25	67	15,5	9 ... 15,0 mm	1,6	B84299-K56	×	×	×

× = approval granted

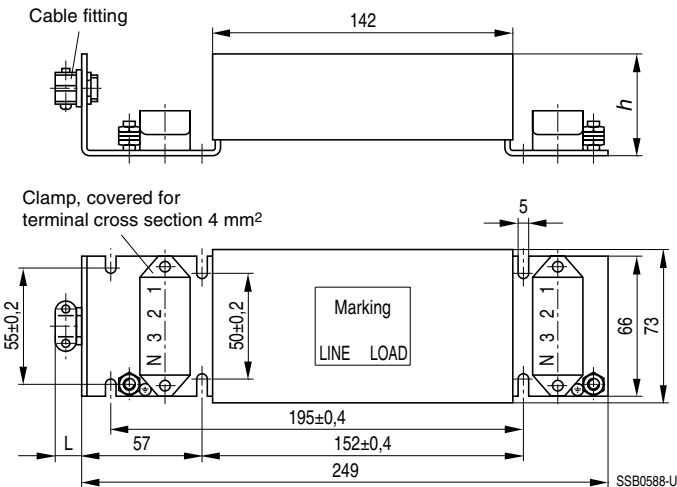
Dimensional drawing

Insertion loss (typical values at $Z = 50 \Omega$)

- unsymmetrical, adjacent branches terminated
- - - - - common mode, all branches in parallel (asymmetrical)
- - - - - differential mode (symmetrical)

B84299-K53

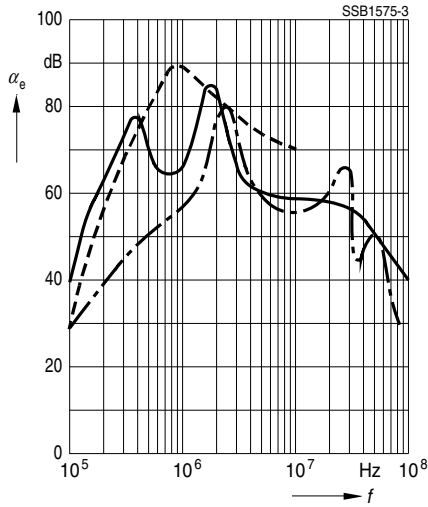

B84299-K55

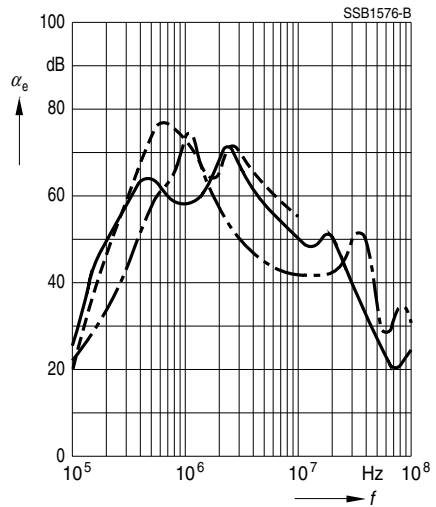

B84299-K56

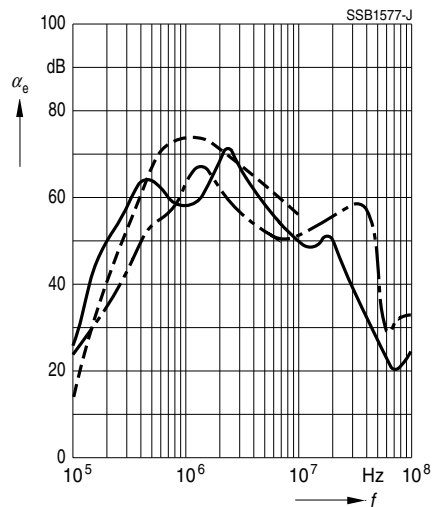

Herausgegeben von EPCOS AG

Marketing Kommunikation, Postfach 80 17 09, 81617 München, DEUTSCHLAND

© EPCOS AG 2000. Alle Rechte vorbehalten. Vervielfältigung, Veröffentlichung, Verbreitung und Verwertung dieser Broschüre und ihres Inhalts ohne ausdrückliche Genehmigung der EPCOS AG nicht gestattet.

Mit den Angaben in dieser Broschüre werden die Bauelemente spezifiziert, keine Eigenschaften zugesichert. Bestellungen unterliegen den vom ZVEI empfohlenen Allgemeinen Lieferbedingungen für Erzeugnisse und Leistungen der Elektroindustrie, soweit nichts anderes vereinbart wird.

Diese Broschüre ersetzt die vorige Ausgabe.

Fragen über Technik, Preise und Liefermöglichkeiten richten Sie bitte an den Ihnen nächstgelegenen Vertrieb der EPCOS AG oder an unsere Vertriebsgesellschaften im Ausland.

Bauelemente können aufgrund technischer Erfordernisse Gefahrstoffe enthalten. Auskünfte darüber bitten wir unter Angabe des betreffenden Typs ebenfalls über die zuständige Vertriebsgesellschaft einzuholen.

Published by EPCOS AG

Marketing Communications, P.O. Box 80 17 09, 81617 Munich, GERMANY

© EPCOS AG 2000. All Rights Reserved. Reproduction, publication and dissemination of this brochure and the information contained therein without EPCOS' prior express consent is prohibited.

The information contained in this brochure describes the type of component and shall not be considered as guaranteed characteristics. Purchase orders are subject to the General Conditions for the Supply of Products and Services of the Electrical and Electronics Industry recommended by the ZVEI (German Electrical and Electronic Manufacturers' Association), unless otherwise agreed.

This brochure replaces the previous edition.

For questions on technology, prices and delivery please contact the Sales Offices of EPCOS AG or the international Representatives.

Due to technical requirements components may contain dangerous substances. For information on the type in question please also contact one of our Sales Offices.