

APPROVED: _____
 DATE: _____ TITLE: _____

Rev	AWO #	Description	Date	Appr
-		RELEASED	12/6/21	
A		ADDED DRAWING	5/27/22	WX/RC

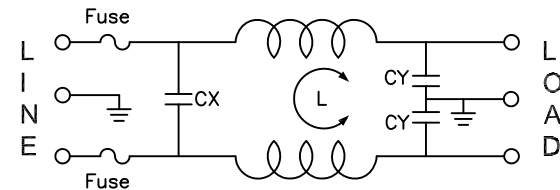

L:2x0.3mH
 Cx:0.1uF(X2)
 Cy:3300pF(Y2)*2

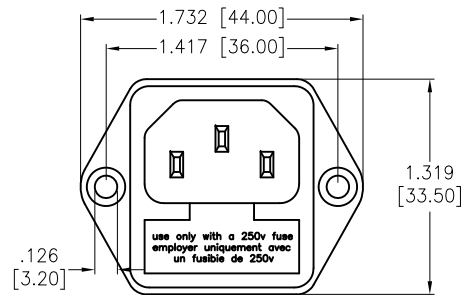
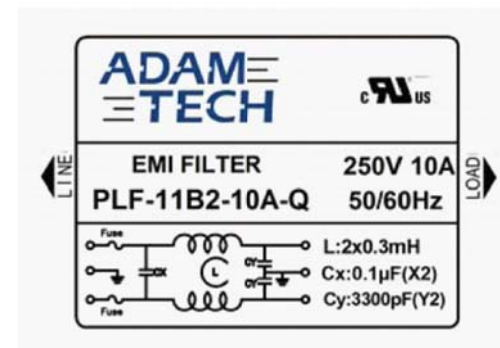
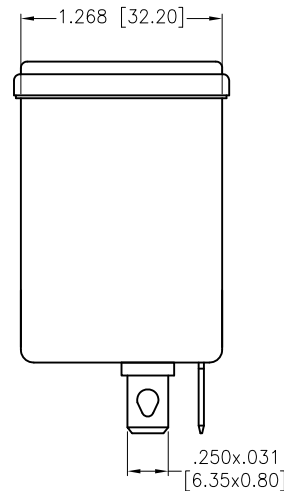
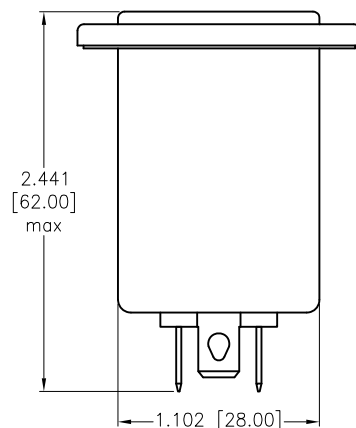
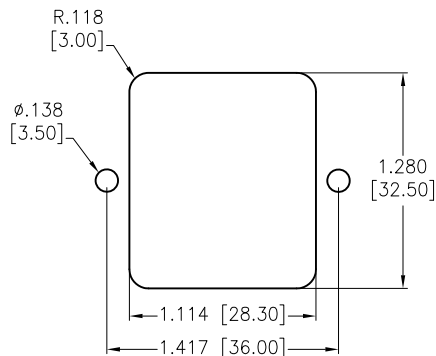

SPECIFICATIONS:

Electrical:

Voltage rating: 115/250 VAC
 Current rating: 115/250 VAC: 10A RMS max
 Leakage Current: Each Line To Ground
 @115VAC/60HZ 0.4mA max
 @250VAC/50HZ 0.8mA max

Hipot Rating(For 1 Minute)

A. Line to Ground: 2,250 VDC
 B. Line to Line: 1450 VDC

IR: 50 Mohm @500 VDC Any Input or Output to Ground

Temperature Rating:
 -25°C to +85°C

Environmental:

Lead free, RoHS compliant



UNLESS OTHERWISE SPECIFIED ALL DIMENSIONS ARE INCHES [MM]. TOLERANCES: EXCEPT AS NOTED

INCHES		HOLES	
.X	± .10	Ø.X	±.10
.XX	± .020	Ø.XX	±.015
.XXX	± .015	Ø.XXX	±.010



909 Rahway Avenue,
 Union, NJ 07083
 Phone: 908-687-5000
 Fax: 908-687-5710

DRAWN	LH	12/6/21
CHECKED	RC	12/6/21
APPROVED		

TITLE: EMI/RF POWER FILTER, FUSED
 INLET SOCKET W/FLANGE MOUNTING

THIS DRAWING CONTAINS INFORMATION THAT IS PROPRIETARY AND SHOULD NOT BE USED WITHOUT PRIOR WRITTEN PERMISSION FROM ADAM TECH

SIZE X	PART NO. PLF-11B2-10A-Q	REV. A
REF: S00205C	SCALE: NTS	SHEET 1 OF 2

6

5

4

3

2

1

Rev	AWO #	Description	Date	Appr
-----	-------	-------------	------	------

SEE SHT 1 OF 2 FOR REVISION

APPROVED: _____

DATE: _____ TITLE: _____

INSERTION LOSS(IN 50 ohm system according IEC/CISPR

(common mode)

(differential mode)

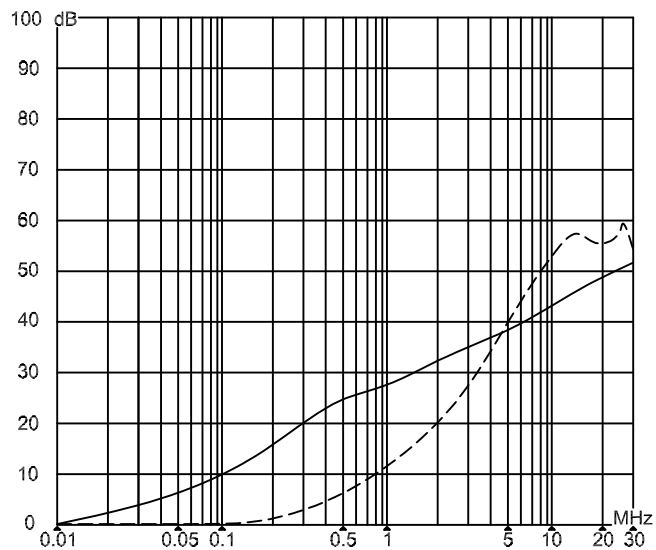

UNLESS OTHERWISE SPECIFIED ALL DIMENSIONS ARE INCHES [MM]. TOLERANCES: EXCEPT AS NOTED

INCHES		HOLES	
.x	± .10	∅x	± .10
.xx	± .020	∅xx	± .015
.xxx	± .015	∅xxx	± .010



909 Rahway Avenue,
Union, NJ 07083
Phone: 908-687-5000
Fax: 908-687-5710

DRAWN	LH	12/6/21
CHECKED	RC	12/6/21
APPROVED		

TITLE	EMI/RF POWER FILTER, FUSED INLET SOCKET W/FLANGE MOUNTING	
-------	--	--

THIS DRAWING CONTAINS INFORMATION THAT IS PROPRIETARY AND SHOULD NOT BE USED WITHOUT PRIOR WRITTEN PERMISSION FROM ADAM TECH

SIZE	PART NO.	REV.
X	PLF-11B2-10A-Q	A

REF:	S00205C	SCALE:	NTS	SHEET	2 OF 2
------	---------	--------	-----	-------	--------

6

5

4

3

2

1