

Integrated Load Switch

FDC6330L



TSOT-23-6
CASE 419BL

Description

This device is particularly suited for compact power management in portable electronic equipment where 3 V to 20 V input and 2.3 A output current capability are needed. This load switch integrates a small N-Channel power MOSFET (Q1) which drives a large P-Channel power MOSFET (Q2) in one tiny SUPERSOT™-6 package.

Features

- $V_{DRO}P = 0.20\text{ V @ } V_{IN} = 12\text{ V, } I_L = 2.5\text{ A, } R_{(on)} = 0.08\ \Omega$
- $V_{DRO}P = 0.20\text{ V @ } V_{IN} = 5\text{ V, } I_L = 1.6\text{ A, } R_{(on)} = 0.125\ \Omega$
- Control MOSFET (Q1) Includes Zener Protection for ESD Ruggedness (> 6 kV Human Body Model)
- High Performance POWER TRENCH® Technology for Extremely Low On-Resistance
- SUPERSOT-6 Package Design Using Copper Lead Frame for Superior Thermal and Electrical Capabilities
- This is a Pb-Free and Halide Free Device

Application

- Power Management
- Load Actuation

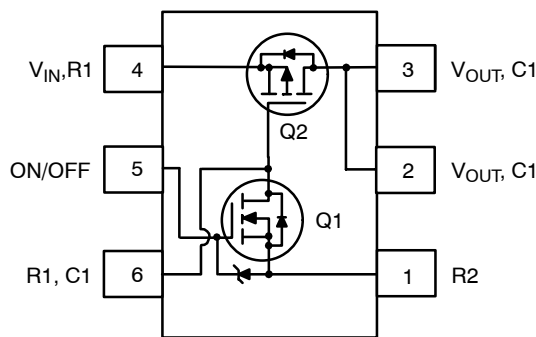

See Application Circuit (Figure 2)

Figure 1.

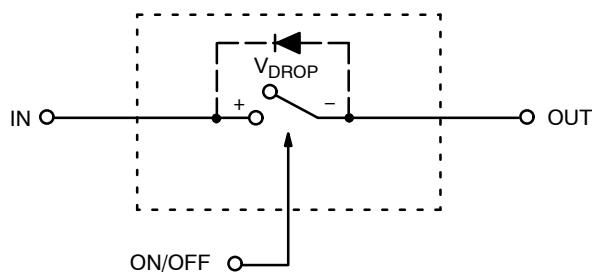
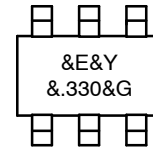

Figure 2. Equivalent Circuit

MARKING DIAGRAM



- &E = Designates Space
- &Y = Binary Calendar Year Coding Scheme
- &. = Pin One Dot
- 330 = Specific Device Code
- &G = Date Code

ORDERING INFORMATION

Device	Package	Shipping†
FDC6330L	TSOT-23-6 (Pb-Free)	3000 / Tape & Reel

†For information on tape and reel specifications, including part orientation and tape sizes, please refer to our Tape and Reel Packaging Specification Brochure, BRD8011/D.

FDC6330L

ABSOLUTE MAXIMUM RATINGS $T_A = 25^\circ\text{C}$ unless otherwise noted

Symbol	Parameter	Value	Unit
V_{IN}	Input Voltage Range (Note 1)	3 – 20	V
$V_{ON/OFF}$	On/Off Voltage Range	1.5 – 8	V
I_D	Load Current – Continuous (Note 2)	2.3	A
	Load Current – Pulsed	10	
P_D	Maximum Power Dissipation (Note 1)	0.7	W
T_J, T_{STG}	Operating and Storage Temperature Range	-55 to 150	$^\circ\text{C}$
ESD	Electrostatic Discharge Rating MIL-STD-883D Human Body Model (100 pF / 1500 Ω)	6	kV

Stresses exceeding those listed in the Maximum Ratings table may damage the device. If any of these limits are exceeded, device functionality should not be assumed, damage may occur and reliability may be affected.

THERMAL CHARACTERISTICS $T_A = 25^\circ\text{C}$ unless otherwise noted

Symbol	Parameter	Value	Unit
$R_{\theta JA}$	Thermal Resistance, Junction-to-Ambient (Note 2)	180	$^\circ\text{C}/\text{W}$
$R_{\theta JC}$	Thermal Resistance, Junction-to-Case (Note 2)	60	$^\circ\text{C}/\text{W}$

ELECTRICAL CHARACTERISTICS $T_A = 25^\circ\text{C}$ unless otherwise noted

Symbol	Parameter	Test Conditions	Min	Typ	Max	Unit
OFF CHARACTERISTICS						
I_{FL}	Leakage Current	$V_{IN} = 20\text{ V}, V_{ON/OFF} = 0\text{ V}$	-	-	1	μA
ON CHARACTERISTICS (Note 3)						
V_{DROP}	Conduction Voltage	$V_{IN} = 12\text{ V}, V_{ON/OFF} = 3.3\text{ V}, I_L = 2.5\text{ A}$	-	-	0.2	V
		$V_{IN} = 5\text{ V}, V_{ON/OFF} = 3.3\text{ V}, I_L = 1.6\text{ A}$	-	-	0.2	
$R_{DS(on)}$	Q_2 – Static On-Resistance	$V_{GS} = -12\text{ V}, I_D = -2.3\text{ A}$	-	0.054	0.08	Ω
		$V_{GS} = -5\text{ V}, I_D = -1.9\text{ A}$	-	0.081	0.125	
I_L	Load Current	$V_{DROP} = 0.2\text{ V}, V_{IN} = 12\text{ V}, V_{ON/OFF} = 3.3\text{ V}$	2.5	-	-	A
		$V_{DROP} = 0.2\text{ V}, V_{IN} = 5\text{ V}, V_{ON/OFF} = 3.3\text{ V}$	1.6	-	-	

Product parametric performance is indicated in the Electrical Characteristics for the listed test conditions, unless otherwise noted. Product performance may not be indicated by the Electrical Characteristics if operated under different conditions.

NOTES:

- Range of V_{in} can be up to 30 V, but R_1 and R_2 must be scaled such that V_{GS} of Q_2 does not exceed 20 V.
- $R_{\theta JA}$ is the sum of the junction-to-case and case-to-ambient thermal resistance where the case thermal reference is defined as the solder mounting surface of the drain pins. $R_{\theta JC}$ is guaranteed by design while $R_{\theta JA}$ is determined by the user's board design.
- Pulse Test: Pulse Width $\leq 300\ \mu\text{s}$, Duty Cycle $\leq 2.0\%$.

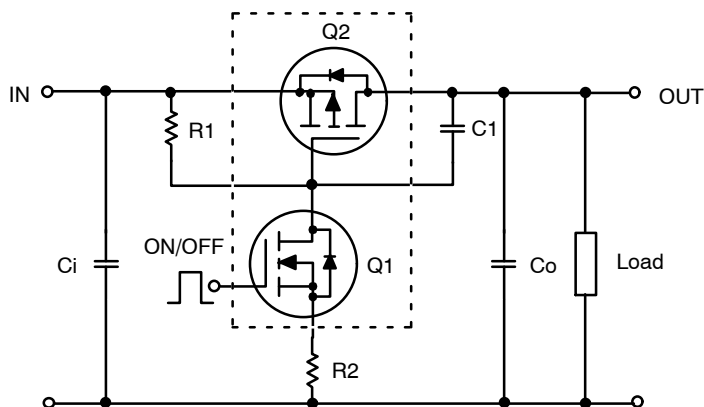

External Component Recommendation:

For applications where $C_o \leq 1\ \mu\text{F}$.
 For slew rate control, select R_2 in the range of 1k – 4.7 k Ω .
 For additional in-rush current control, $C_1 \leq 1000\ \text{pF}$ can be added.
 Select R_1 so that the R_1/R_2 ratio ranges from 10–100.
 R_1 is required to turn Q_2 off.

Figure 3. FDC6330L Load Switch Application

TYPICAL CHARACTERISTICS

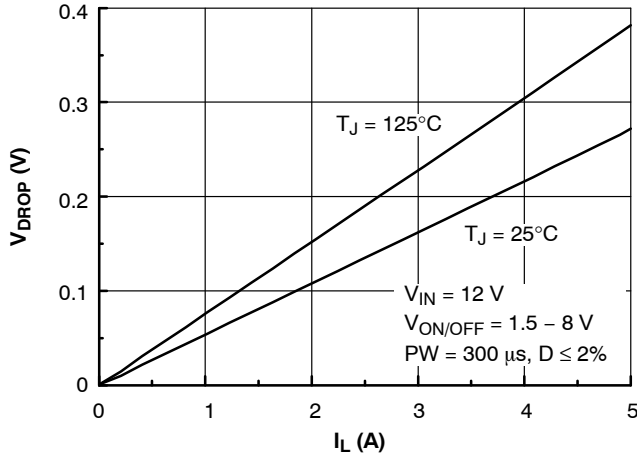

Figure 4. Conduction Voltage Drop Variation with Load Current

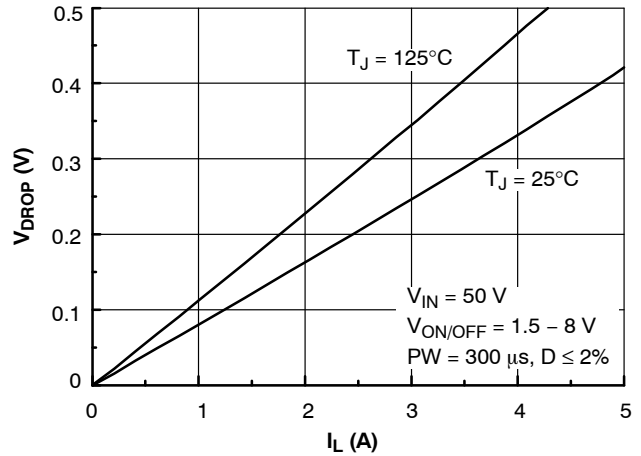

Figure 5. Conduction Voltage Drop Variation with Load Current

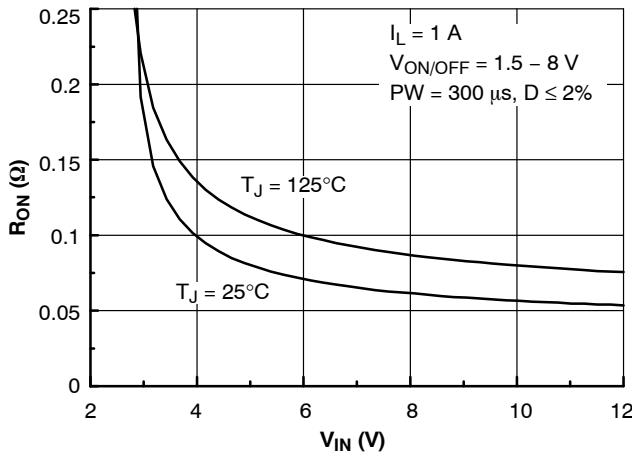

Figure 6. On-Resistance Variation with Input Voltage

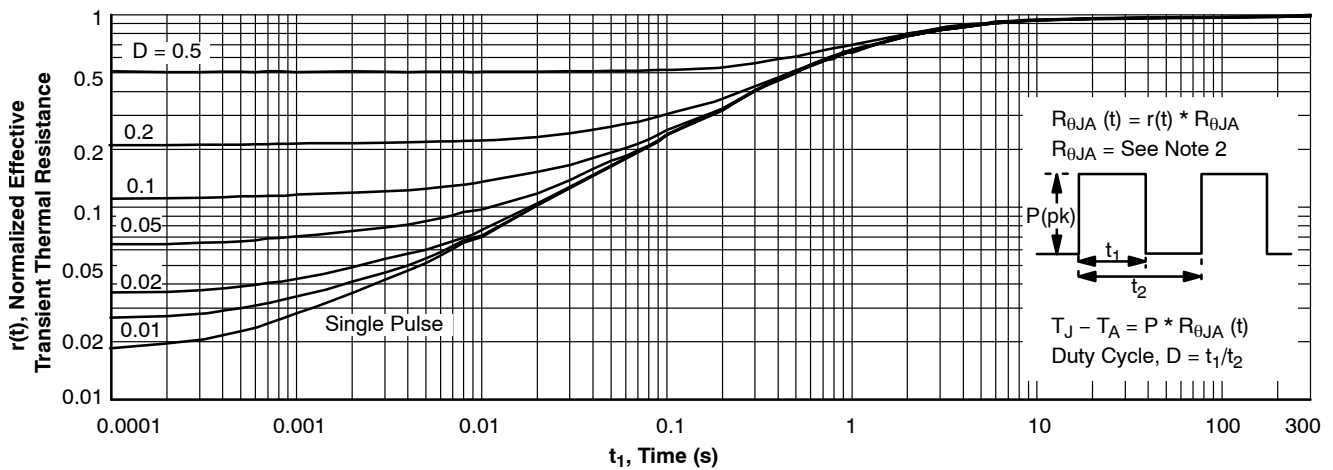

Figure 7. Transient Thermal Response Curve

NOTE: Thermal characterization performed on the conditions described in Note 2. Transient thermal response will change depending on the circuit board design.

SUPERSOT is a trademark and POWERTRENCH is a registered trademark of Semiconductor Components Industries, LLC dba "onsemi" or its affiliates and/or subsidiaries in the United States and/or other countries.

MECHANICAL CASE OUTLINE

PACKAGE DIMENSIONS

ON Semiconductor®



SCALE 2:1

TSOT23 6-Lead CASE 419BL ISSUE A

DATE 31 AUG 2020

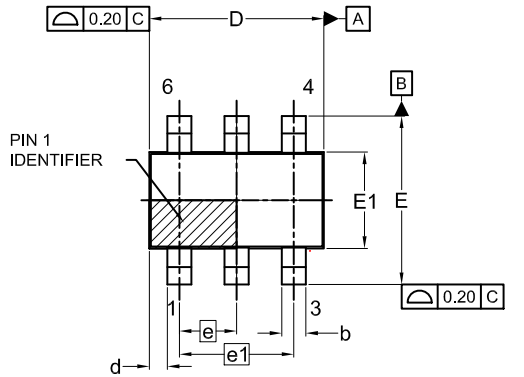

TOP VIEW

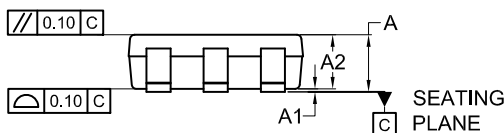

FRONT VIEW

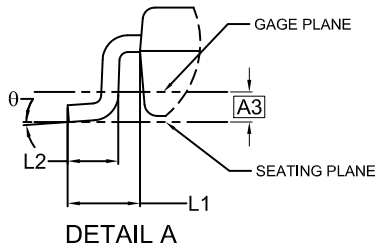

DETAIL A

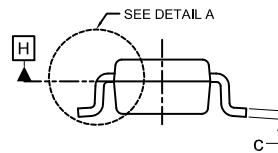

SIDE VIEW

SYMM

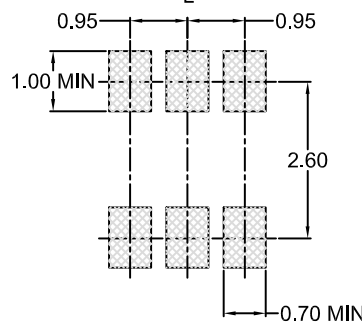

LAND PATTERN
RECOMMENDATION

*FOR ADDITIONAL INFORMATION ON OUR Pb-FREE STRATEGY AND SOLDERING DETAILS, PLEASE DOWNLOAD THE ON SEMICONDUCTOR SOLDERING AND MOUNTING TECHNIQUES REFERENCE MANUAL, SOLDERRM/D.

NOTES:

1. DIMENSIONING AND TOLERANCING PER ASME Y14.5M, 2009.
2. CONTROLLING DIMENSION: MILLIMETERS
3. DIMENSIONS D AND E1 DO NOT INCLUDE MOLD FLASH, PROTRUSIONS, OR GATE BURRS. MOLD FLASH, PROTRUSIONS OR GATE BURRS SHALL NOT EXCEED 0.25MM PER END. DIMENSIONS D AND E1 ARE DETERMINED AT DATUM H.
4. SEATING PLANE IS DEFINED BY THE TERMINALS. "A1" IS DEFINED AS THE DISTANCE FROM THE SEATING PLANE TO THE LOWEST POINT ON THE PACKAGE BODY.

DIM	MILLIMETERS		
	MIN.	NOM.	MAX.
A	0.90	1.00	1.10
A1	0.00	0.05	0.10
A2	0.70	0.85	1.00
A3	0.25 BSC		
b	0.25	0.38	0.50
c	0.10	0.18	0.26
D	2.80	2.95	3.10
d	0.30 REF		
E	2.50	2.75	3.00
E1	1.30	1.50	1.70
e	0.95 BSC		
e1	1.90 BSC		
L1	0.60 REF		
L2	0.20	0.40	0.60
Θ	0°	--	10°

GENERIC MARKING DIAGRAM*

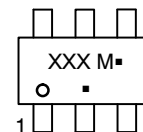

XXX = Specific Device Code
M = Date Code
▪ = Pb-Free Package

(Note: Microdot may be in either location)

*This information is generic. Please refer to device data sheet for actual part marking. Pb-Free indicator, "G" or microdot "▪", may or may not be present. Some products may not follow the Generic Marking.

DOCUMENT NUMBER:	98AON83292G	Electronic versions are uncontrolled except when accessed directly from the Document Repository. Printed versions are uncontrolled except when stamped "CONTROLLED COPY" in red.
DESCRIPTION:	TSOT23 6-Lead	PAGE 1 OF 1

ON Semiconductor and ON are trademarks of Semiconductor Components Industries, LLC dba ON Semiconductor or its subsidiaries in the United States and/or other countries. ON Semiconductor reserves the right to make changes without further notice to any products herein. ON Semiconductor makes no warranty, representation or guarantee regarding the suitability of its products for any particular purpose, nor does ON Semiconductor assume any liability arising out of the application or use of any product or circuit, and specifically disclaims any and all liability, including without limitation special, consequential or incidental damages. ON Semiconductor does not convey any license under its patent rights nor the rights of others.

onsemi, **Onsemi**, and other names, marks, and brands are registered and/or common law trademarks of Semiconductor Components Industries, LLC dba "**onsemi**" or its affiliates and/or subsidiaries in the United States and/or other countries. **onsemi** owns the rights to a number of patents, trademarks, copyrights, trade secrets, and other intellectual property. A listing of **onsemi**'s product/patent coverage may be accessed at www.onsemi.com/site/pdf/Patent-Marking.pdf. **onsemi** reserves the right to make changes at any time to any products or information herein, without notice. The information herein is provided "as-is" and **onsemi** makes no warranty, representation or guarantee regarding the accuracy of the information, product features, availability, functionality, or suitability of its products for any particular purpose, nor does **onsemi** assume any liability arising out of the application or use of any product or circuit, and specifically disclaims any and all liability, including without limitation special, consequential or incidental damages. Buyer is responsible for its products and applications using **onsemi** products, including compliance with all laws, regulations and safety requirements or standards, regardless of any support or applications information provided by **onsemi**. "Typical" parameters which may be provided in **onsemi** data sheets and/or specifications can and do vary in different applications and actual performance may vary over time. All operating parameters, including "Typicals" must be validated for each customer application by customer's technical experts. **onsemi** does not convey any license under any of its intellectual property rights nor the rights of others. **onsemi** products are not designed, intended, or authorized for use as a critical component in life support systems or any FDA Class 3 medical devices or medical devices with a same or similar classification in a foreign jurisdiction or any devices intended for implantation in the human body. Should Buyer purchase or use **onsemi** products for any such unintended or unauthorized application, Buyer shall indemnify and hold **onsemi** and its officers, employees, subsidiaries, affiliates, and distributors harmless against all claims, costs, damages, and expenses, and reasonable attorney fees arising out of, directly or indirectly, any claim of personal injury or death associated with such unintended or unauthorized use, even if such claim alleges that **onsemi** was negligent regarding the design or manufacture of the part. **onsemi** is an Equal Opportunity/Affirmative Action Employer. This literature is subject to all applicable copyright laws and is not for resale in any manner.

PUBLICATION ORDERING INFORMATION

LITERATURE FULFILLMENT:

Email Requests to: orderlit@onsemi.com

onsemi Website: www.onsemi.com

TECHNICAL SUPPORT

North American Technical Support:
Voice Mail: 1 800-282-9855 Toll Free USA/Canada
Phone: 011 421 33 790 2910

Europe, Middle East and Africa Technical Support:

Phone: 00421 33 790 2910

For additional information, please contact your local Sales Representative