

Description

The AP22815/615 is a 3A single-channel current-limited high-side power switch with output OVP optimized for USB and other hot-swap applications, which must have overvoltage protection from output to protection the system. The AP22815/615 complies with USB standards and is available with both polarities of Enable input. AP22815 supports fixed current-limited feature, while AP22615 equips adjustable current-limited feature optimized for applications that require precision current limiting support. It supports USB PD3.0 fast role-swap function. The output voltage could recovery to USB valid voltage range within 110µs during USB PD fast role-swap event.

The device has fast short-circuit and output overvoltage response time for improved overall system robustness. Both TSOT25 and TSOT26 packages integrate discharge circuitry inside OUT pin. They provide a complete protection solution for applications subject to heavy capacitive loads and the prospect of short circuit, and offer output overvoltage protection, reverse-current protection, overcurrent, overtemperature and short-circuit protection, as well as controlled rise time and undervoltage lockout functionality. A 7ms deglitch capability on the open-drain flag output prevents false overcurrent, overvoltage, and overtemperature reporting and does not require any external components.

The AP22815 is available in a standard green TSOT25 package with RoHS compliant. The AP22615 is available in a standard Green TSOT26 package with RoHS compliant.

Features

- Input Voltage Range: 3.0V to 5.5V
- 40mΩ On-Resistance
- Built-In Soft-Start with 2.1ms Typical Rise Time
- Fault Report (FLG) with Blanking Time (7ms Typ)
- Accurate Adjustable Current Limit, 0.4A to 4.0A (AP22615 Only)
- ESD Protection: 2kV HBM, 200V MM
- Active Low or Active High Enable
- Protection
 - Output Overvoltage with Auto Recovery
 - Overcurrent with Auto Recovery
 - Short-Circuit with Auto Recovery
 - Overtemperature with Auto Recovery
- Output Reverse Voltage/Current Protection
- Fast Role Swap Function
- Thermally Efficient Low Profile Package
- UL Recognized, File Number E322375
- IEC60950-1 CB Scheme Certified
- IEC62368-1 CB Scheme Certified
- **Totally Lead-Free & Fully RoHS Compliant (Notes 1 & 2)**
- **Halogen and Antimony Free. "Green" Device (Note 3)**

- Notes:
1. No purposely added lead. Fully EU Directive 2002/95/EC (RoHS), 2011/65/EU (RoHS 2) & 2015/863/EU (RoHS 3) compliant.
 2. See <https://www.diodes.com/quality/lead-free/> for more information about Diodes Incorporated's definitions of Halogen- and Antimony-free, "Green" and Lead-free.
 3. Halogen- and Antimony-free "Green" products are defined as those which contain <900ppm bromine, <900ppm chlorine (<1500ppm total Br + Cl) and <1000ppm antimony compounds.

Pin Assignments

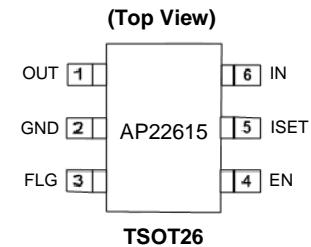
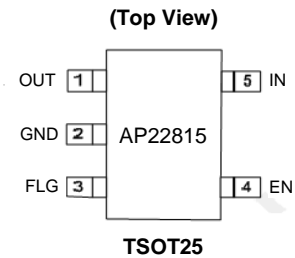

Applications

- Integrated Load Switches in Ultrabook PC
- Power Up/Down Sequencing in Ultrabook PC
- Notebook, Netbook, Tablet PC, Set-Top Box
- SSD (Solid State Drives)
- Consumer Electronics
- USB Charger
- Telecom Systems

Typical Applications Circuit (Note 4)

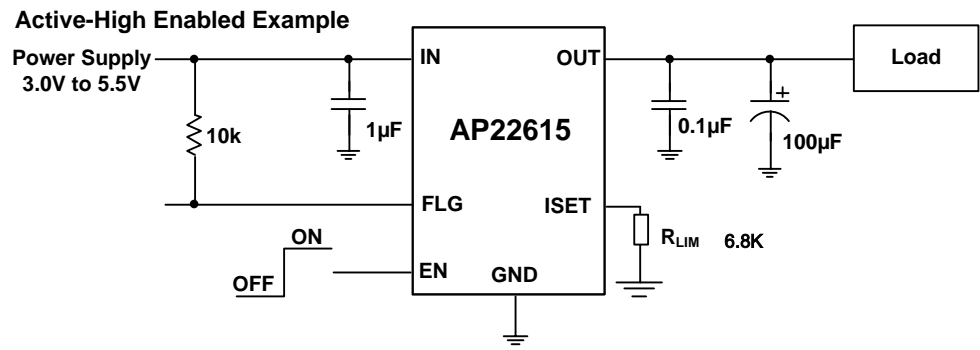
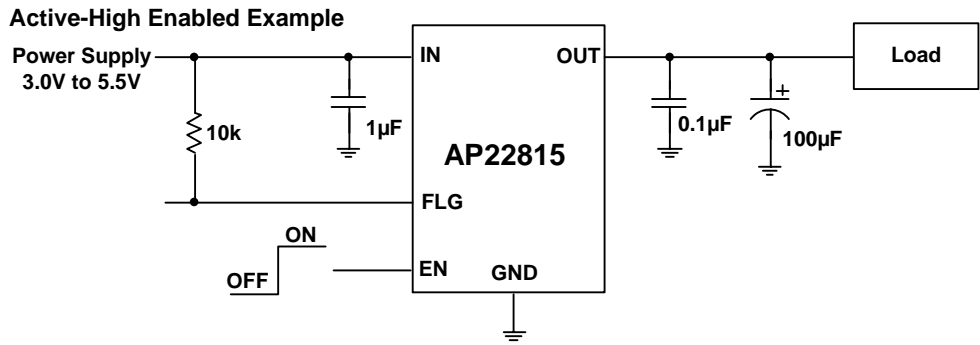

Note 4: Applying a 1µF input capacitor leads to a large V_{IN} spike, so it is recommended to use a 10µF capacitor instead.

Pin Descriptions

AP22815	AP22615	Pin Name	Pin function
TSOT25	TSOT26		
1	1	OUT	Voltage Output Pin
2	2	GND	Ground Pin of the Circuitry
3	3	FLG	Overcurrent and Overtemperature Fault Report; Open-Drain Flag is Active Low When Triggered.
4	4	EN	Enable Input (Active Low or Active High).
NC	5	ISET	AP22815: NC pin AP22615: Set OCP current by attaching resistor. The current limit: $I_{LIM} (A) = 6800/R_{LIM} (\Omega)$
5	6	IN	Voltage Input Pin

Functional Block Diagram

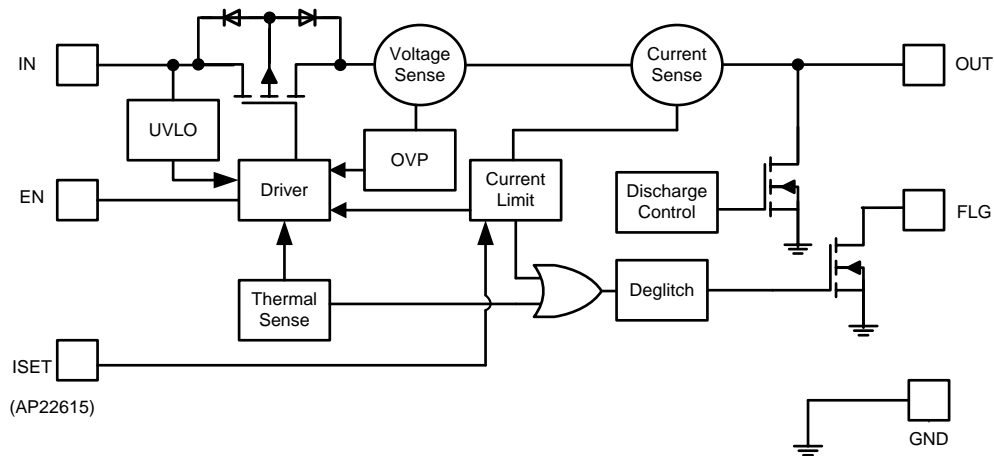

Absolute Maximum Ratings (@ $T_A = +25^\circ\text{C}$, unless otherwise specified.) (Note 5)

Symbol	Parameter	Ratings	Unit	
ESD HBM	Human Body ESD Protection	2000	V	
ESD MM	Machine Model ESD Protection	200	V	
V_{IN}	Input Voltage	-0.3 to 6.0	V	
V_{OUT}	Output Voltage (V_{OUT} to GND, V_{OUT} to V_{IN})	-0.3 to 28	V	
V_{EN}	Enable Voltage	-0.3 to ($V_{IN} + 0.3$)	V	
V_{ISET}	ISET Voltage	-0.3 to ($V_{IN} + 0.3$)	V	
I_L	Load Current	Internal Limited	A	
$T_{J(max)}$	Maximum Junction Temperature	+150	$^\circ\text{C}$	
T_{STG}	Storage Temperature	-65 to +150	$^\circ\text{C}$	
$R_{\theta JA}$	Thermal Resistance, Junction to Ambient (Note 6)	TSOT25	85	$^\circ\text{C/W}$
		TSOT26	80	
$R_{\theta JC}$	Thermal Resistance, Junction to Case (Note 6)	TSOT25	32	$^\circ\text{C/W}$
		TSOT26	30	

- Notes:
- Stresses greater than the *Absolute Maximum Ratings* specified above can cause permanent damage to the device. These are stress ratings only; functional operation of the device at these or any other conditions exceeding those indicated in this specification is not implied. Device reliability can be affected by exposure to absolute maximum rating conditions for extended periods of time.
 - $R_{\theta JA}$ and $R_{\theta JC}$ are measured at $T_A = +25^\circ\text{C}$ on a high effective thermal conductivity four-layer test board per JEDEC 51-7.

Recommended Operating Conditions (Note 7)

Symbol	Parameter	Min	Max	Unit
V_{IN}	Input Voltage	3.0	5.5	V
I_{OUT}	Output Current, $4.0\text{V} \leq V_{IN} \leq 5.5\text{V}$	0	3	A
	Output Current, $3.0\text{V} \leq V_{IN} < 4.0\text{V}$	0	1.5	A
V_{IL}	EN Input Logic Low Voltage	0	0.4	V
R_{LIM}	Current-Limit Threshold Resistor Range (1% Initial Tolerance)	1.94	6.8	$\text{k}\Omega$
V_{OUT}	Output Voltage	0	23	V
V_{IH}	EN Input Logic High Voltage	1.2	V_{IN}	V
T_A	Operating Ambient Temperature	-40	+85	$^\circ\text{C}$

- Note: 7. Refer to the typical application circuit.

Electrical Characteristics ($V_{IN} = 5.0V$ @ $T_A = +25^\circ C$, $C_{IN} = 1\mu F$, $C_L = 100nF$, unless otherwise specified.)

Symbol	Parameter	Test Conditions	Min	Typ	Max	Unit
V_{UVLO}	Input UVLO	V_{IN} Rising	2.1	2.5	2.9	V
ΔV_{UVLO}	Input UVLO Hysteresis	V_{IN} Decreasing	—	180	—	mV
I_{SHDN}	Input Shutdown Current	Disabled, OUT = Open (Discharge Current Included)	—	0.1	10	μA
I_Q	Input Quiescent Current	Enabled, OUT = Open	—	300	—	μA
I_{LEAK}	Input Leakage Current	Disabled, OUT Grounded	—	0.1	1	μA
I_{REV}	Reverse Leakage Current	Disabled, $V_{IN} = 0V$, $V_{OUT} = 5V$, I_{REV} at OUT	—	0.5	15	μA
		Disabled, $V_{IN} = 0V$, $V_{OUT} = 20V$, I_{REV} at OUT	—	0.5	30	μA
$R_{DS(ON)}$	Switch On-Resistance	(AP22815) $V_{IN} = 5.0V$, $I_{OUT} = 1A$	—	40	50	m Ω
I_{LIMIT}	Overload Current Limit	(AP22815) $V_{IN} = 5V$, $V_{OUT} = 4V$	3.1	3.6	4.2	A
		(AP22615) $V_{IN} = 5V$, $V_{OUT} = 4V$, $R_{LIM} = 1.94k\Omega$	3.1	3.6	4.2	A
		(AP22615) $V_{IN} = 5V$, $V_{OUT} = 4V$, $R_{LIM} = 6.8k\Omega$	0.75	1	—	A
I_{SHORT}	Short-Circuit Current Limit	Enabled, Output Short to Ground	—	1	—	A
t_{SHORT}	Short-Circuit Response Time	$V_{IN} = 5V$, No Load	—	5	—	μs
V_{IL}	EN Input Logic Low Voltage	$V_{IN} = 5V$	—	—	0.4	V
V_{IH}	EN Input Logic High Voltage	$V_{IN} = 5V$	1.2	—	—	V
$I_{LEAK-EN}$	EN Input Leakage	$V_{IN} = 5V$, $V_{EN} = 0V$ and $5.5V$	—	1	2	μA
I_{LEAK-O}	Output Leakage Current	Disabled, $V_{OUT} = 0V$	—	0.5	1	μA
$t_{D(ON)}$	Output Turn-On Delay Time	$C_L = 10\mu F$, $R_{LOAD} = 10\Omega$ @ $V_{IN} = 5V$ (Figure 1)	—	2.2	—	ms
t_R	Output Turn-On Rise Time	$C_L = 10\mu F$, $R_{LOAD} = 10\Omega$ @ $V_{IN} = 5V$ (Figure 1)	1.0	1.9	3.5	ms
$t_{D(OFF)}$	Output Turn-Off Delay Time	$C_L = 10\mu F$, $R_{LOAD} = 10\Omega$ @ $V_{IN} = 5V$ (Figure 1)	—	0.02	—	ms
t_F	Output Turn-Off Fall Time	$C_L = 10\mu F$, $R_{LOAD} = 10\Omega$ @ $V_{IN} = 5V$ (Figure 1)	—	0.2	—	ms
R_{FLG}	FLG Output FET On-Resistance	$I_{FLG} = 10mA$	—	40	60	Ω
I_{FOH}	FLG Off Current	$V_{FLG} = 5V$	—	0.01	1	μA
t_{BLANK}	FLG Blanking Time	Assertion or Deassertion due to Overvoltage, Overcurrent, and Overtemperature Condition	2	7	20	ms
R_{DIS}	Discharge Resistance	$V_{IN} = 5V$, Disabled, $V_{OUT} = 1V$	—	100	—	Ω
T_{SHDN}	Thermal Shutdown Threshold	Enabled	—	+140	—	$^\circ C$
T_{HYS}	Thermal Shutdown Hysteresis	—	—	+35	—	$^\circ C$
V_{OV_TRIP}	Output OVP Lockout	V_{OUT} Rising Threshold	5.5	5.7	5.9	V
		V_{OUT} Falling Threshold	—	5.6	—	V
OUT_{HYS}	Output OVP Hysteresis	—	—	0.1	—	V
t_{OVP}	OVP Response Time	$I_{OUT} = 0.5A$, $C_L = 1\mu F$, V_{OUT} from 5.5V to 6V	—	1	—	μs
V_{RVP}	Reverse-Voltage Comparator Trip Point	$V_{OUT} - V_{IN}$	—	65	—	mV

Typical Performance Characteristics

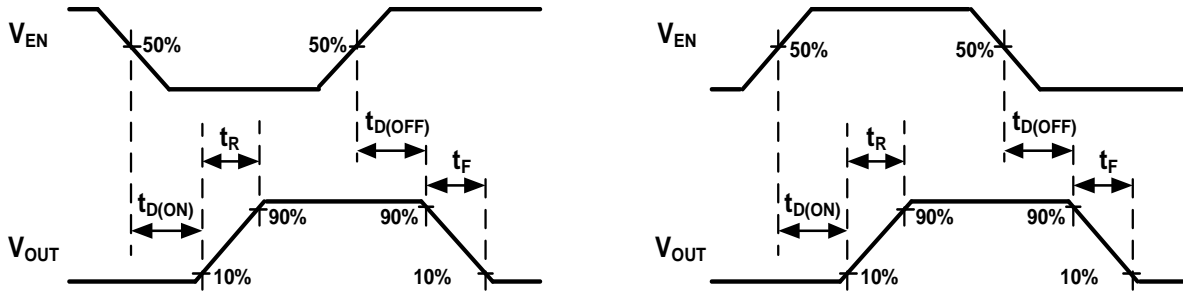
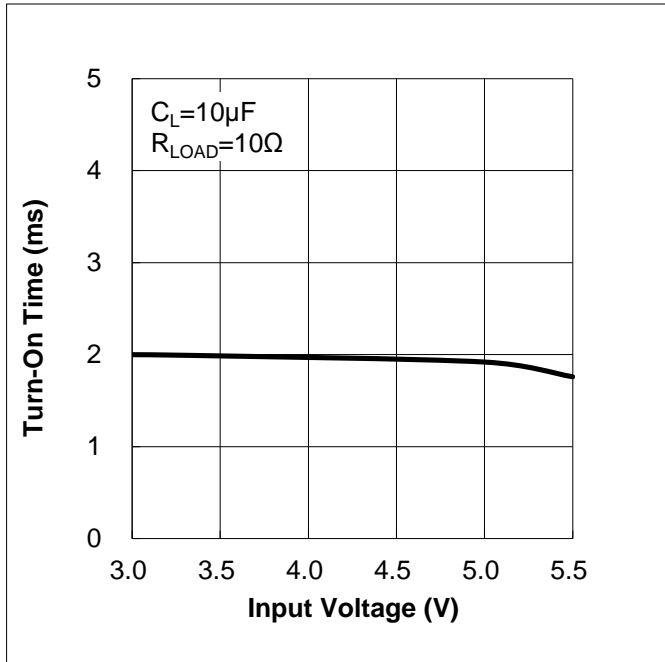

Figure 1. Voltage Waveforms

Typical Performance Characteristics (continued) ($T_A = +25^\circ\text{C}$, $V_{IN} = 5\text{V}$, $C_{IN} = 1\mu\text{F}$, $C_L = 0.1\mu\text{F}$, unless otherwise specified.)

Turn-On Time vs. Input Voltage



Turn-Off Time vs. Input Voltage

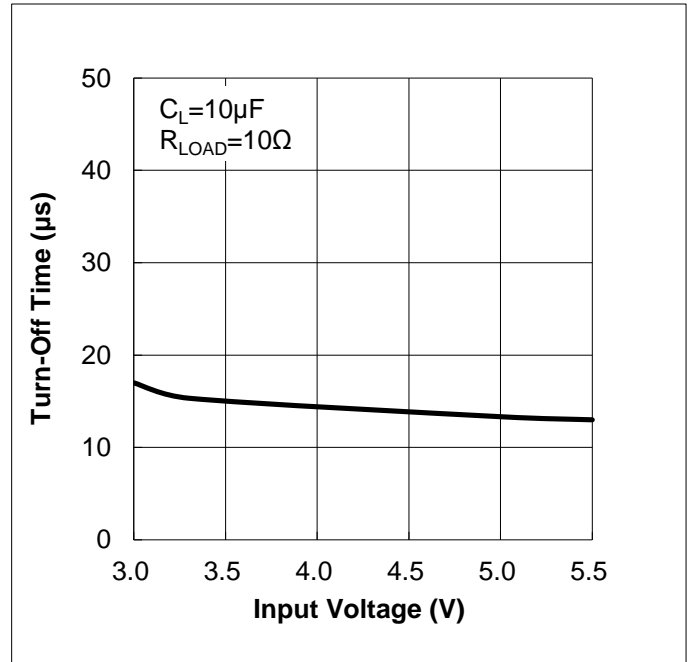

Rise Time vs. Input Voltage

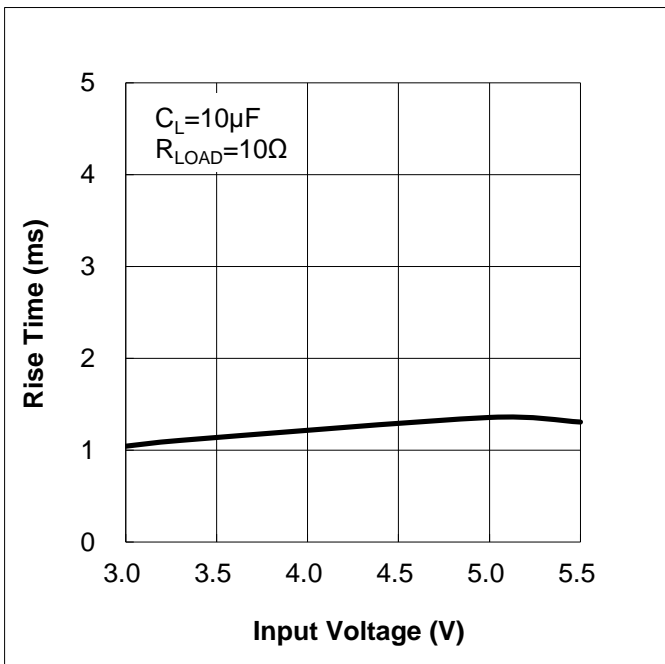

Fall Time vs. Input Voltage

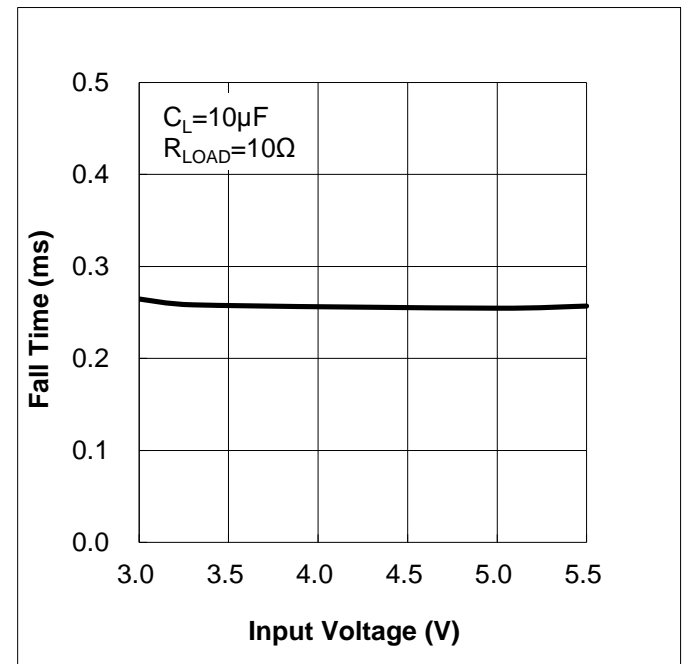

Typical Performance Characteristics (continued) ($T_A = +25^\circ\text{C}$, $V_{IN} = 5\text{V}$, $C_{IN} = 1\mu\text{F}$, $C_L = 0.1\mu\text{F}$, unless otherwise specified.)

Input Quiescent Current vs. Temperature

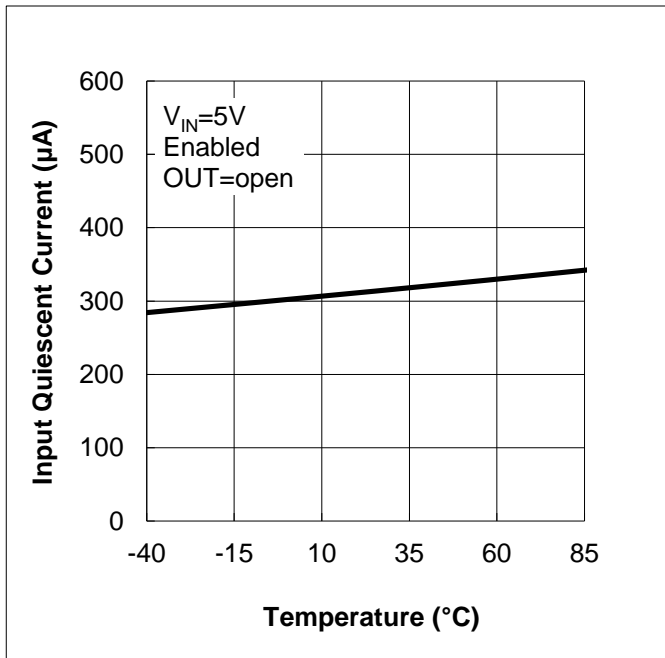

Input Shutdown Current vs. Temperature

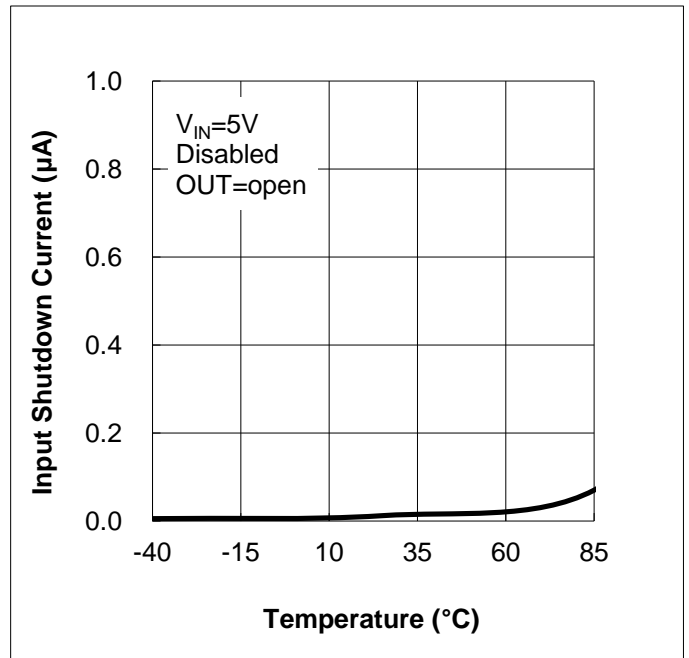

$R_{DS(ON)}$ vs. Output Current

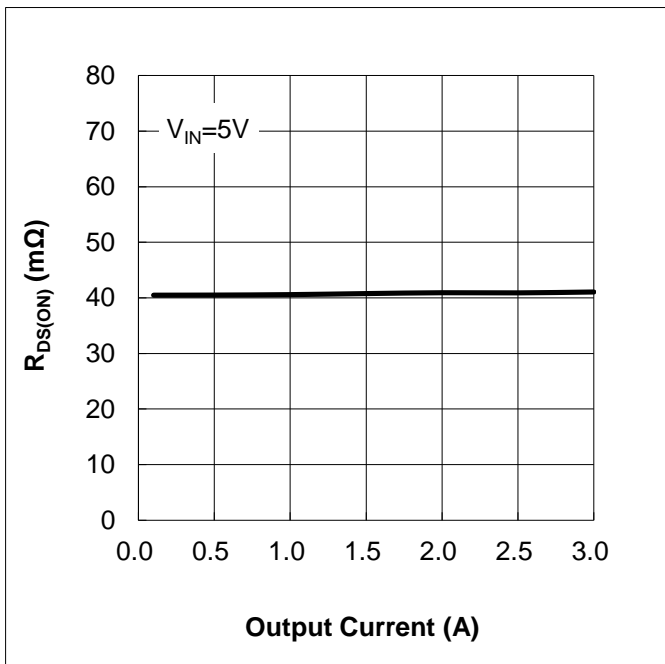

$R_{DS(ON)}$ vs. Temperature

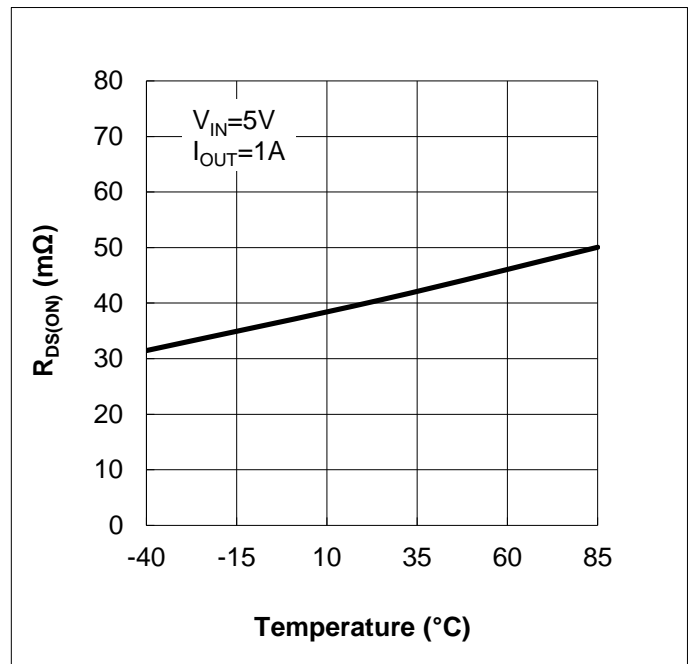

Typical Performance Characteristics (continued) ($T_A = +25^\circ\text{C}$, $V_{IN} = 5\text{V}$, $C_{IN} = 1\mu\text{F}$, $C_L = 0.1\mu\text{F}$, unless otherwise specified.)

Input Leakage Current vs. Temperature

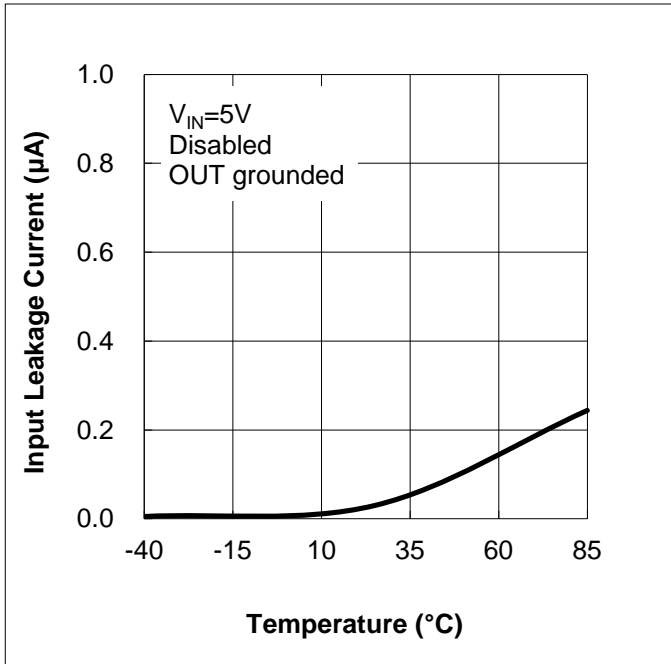

Under Voltage Lockout vs. Temperature

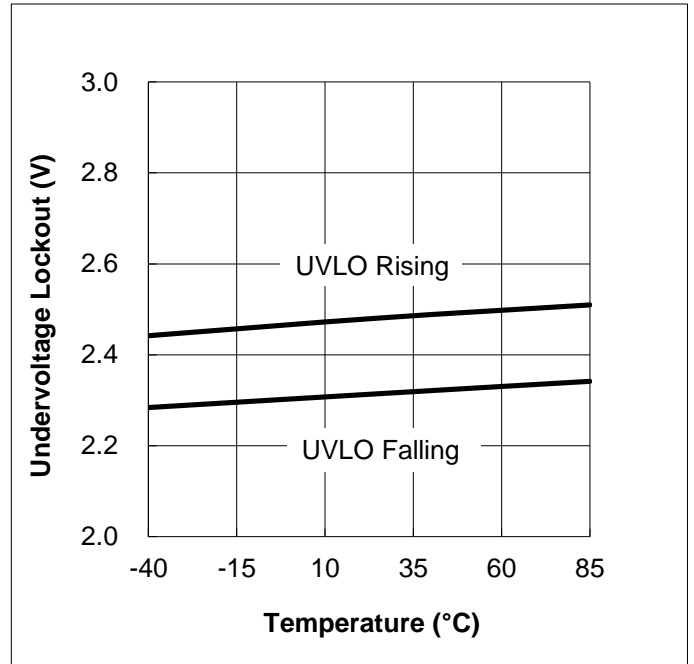

Short-Circuit Output Current vs. Temperature

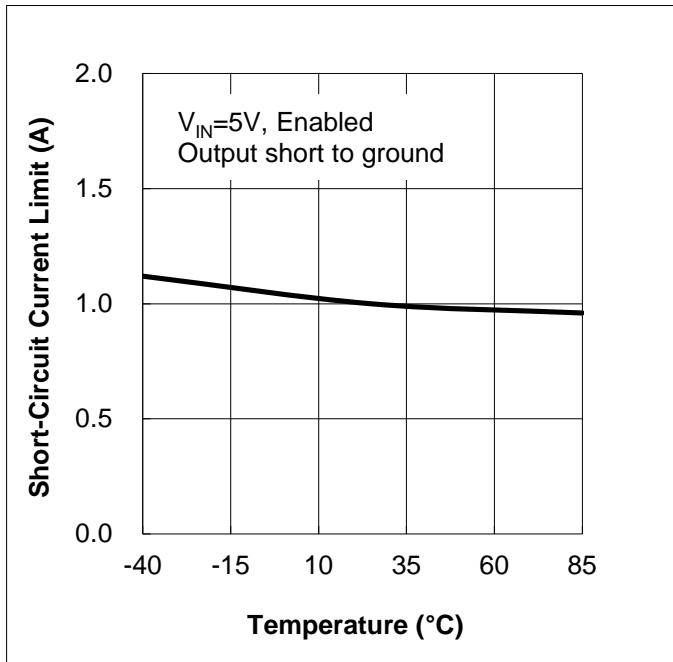

Reverse-Voltage Comparator Trip vs. Temperature

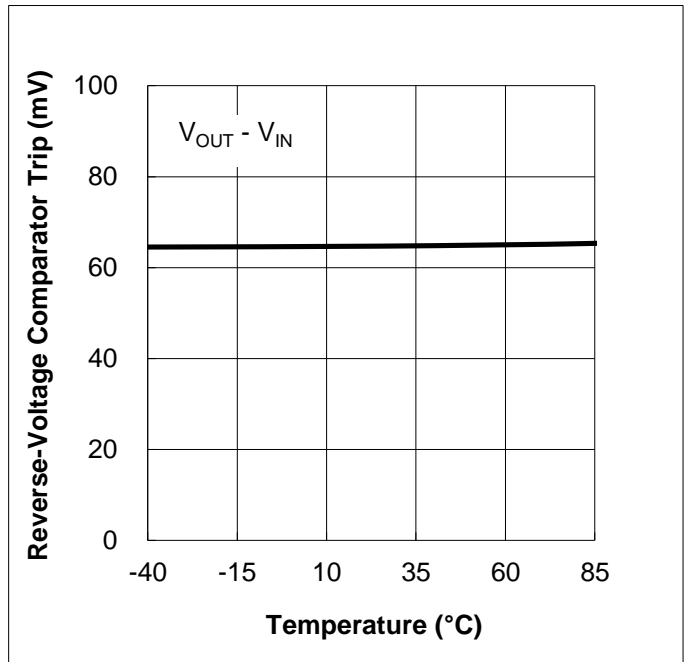

Typical Performance Characteristics (continued) ($T_A = +25^\circ\text{C}$, $V_{IN} = 5\text{V}$, $C_{IN} = 1\mu\text{F}$, $C_L = 0.1\mu\text{F}$, unless otherwise specified.)

Reverse Leakage Current vs. Temperature

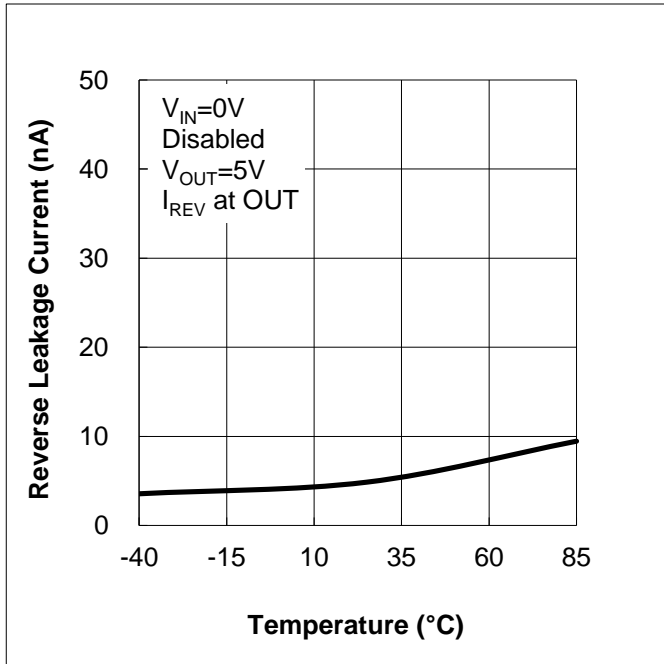

Reverse Leakage Current vs. Temperature

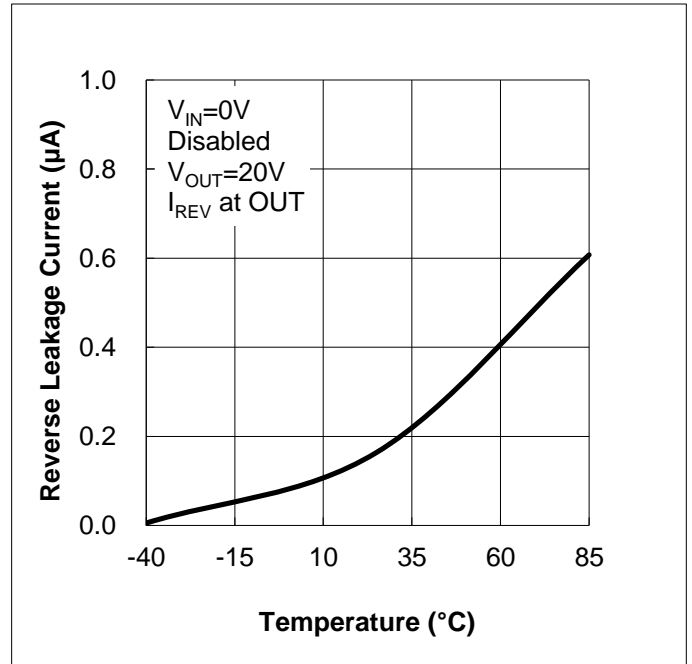

Over Load Current Limit vs. R_{LIMIT}

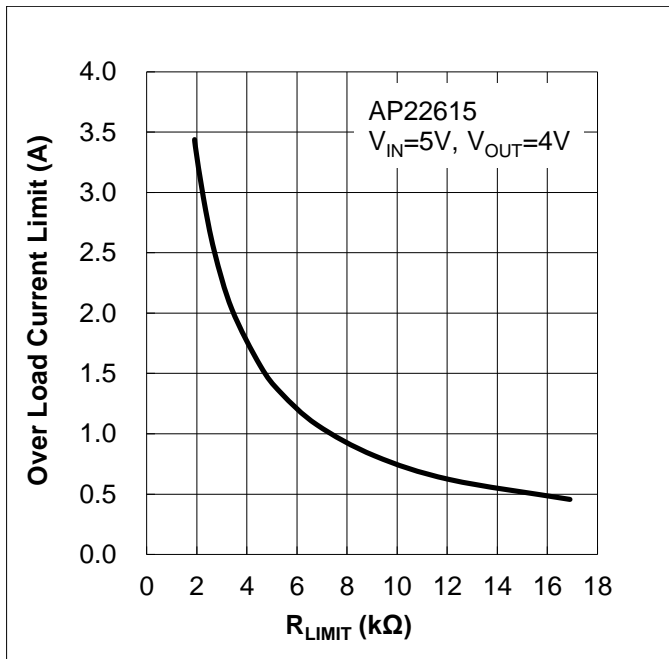

Over Load Current Limit vs. Temperature

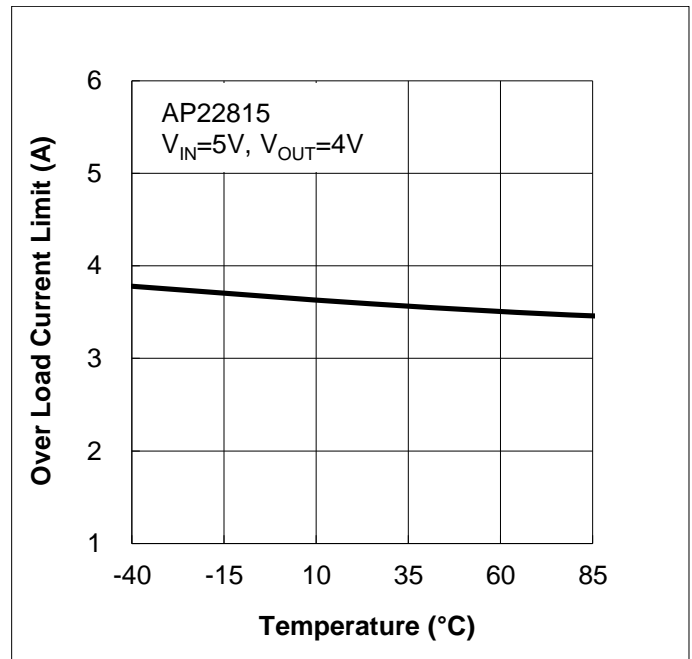

Typical Performance Characteristics (continued) ($T_A = +25^\circ\text{C}$, $V_{IN} = 5\text{V}$, $C_{IN} = 1\mu\text{F}$, $C_L = 0.1\mu\text{F}$, unless otherwise specified.)

Device Enabled Into Short-Circuit

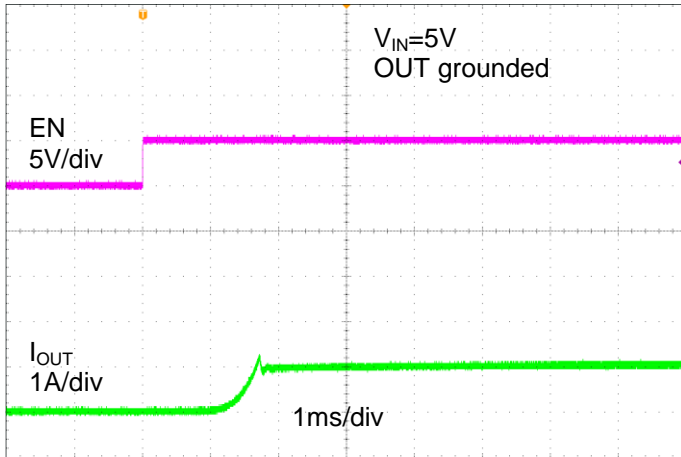

Inrush Current

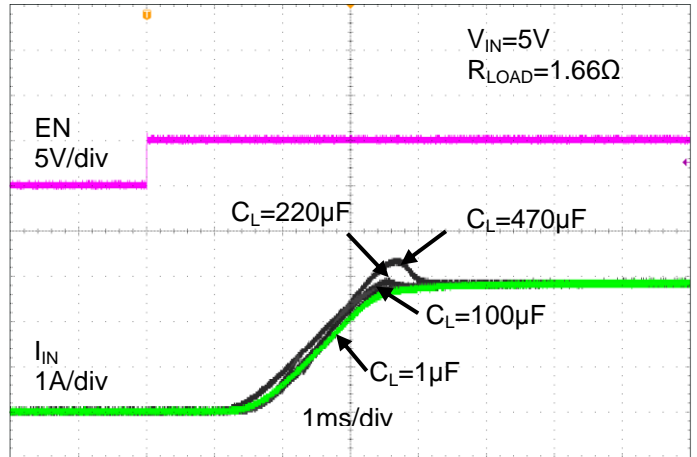

Application Information

Input and Output Capacitors

It is required to place a 1 μ F X7R or X5R ceramic bypass capacitor between IN and GND—close to the device. It is recommended to place a high-value capacitor (10 μ F or 47 μ F) close to input pin when the output transient load is heavy. This precaution reduces power-supply transients that can cause ringing on the input.

Connecting a minimum 100 μ F low ESR electrolytic or tantalum capacitor (or 22 μ F MLCC) between OUT and GND is also required for hot-plug applications, which is required to bypass the output with a 0.1 μ F ceramic capacitor that improves the immunity of the device to short-circuit transients. The bulky 100 μ F or larger capacitors help reduce output droop voltage when a device is plugged in. When abnormal short-circuit condition happens, these capacitors can also reduce output negative voltage due to parasitic inductive effect and avoid device damage.

Note that without the bypass capacitors, an output short can cause ringing on the input. If the voltage is over the maximum voltage rating, it will destroy the internal control circuitry even the duration is short.

FLG Response

When an overcurrent, overtemperature, or out overvoltage shutdown condition is encountered, the FLG open-drain output goes active low after a nominal 7ms deglitch timeout. The FLG output remains low until both overcurrent and overtemperature or out overvoltage conditions are removed. Connecting a heavy capacitive load to the output of the device can cause a momentary overcurrent condition, which does not trigger the FLG due to the 7ms deglitch timeout. The AP22815/AP22615 is designed to eliminate false overcurrent reporting without the requirement of external components to remove unwanted pulses.

When V_{IN} operates below 4V, the lower V_{IN} voltage results in higher equivalent R_{ON} and can potentially cause the FLG signal to be triggered at a higher output current.

Overcurrent and Short-Circuit Protection

An internal-sensing FET is employed to check for overcurrent conditions. Unlike current-sense resistors, sense FETs do not increase the series resistance of the current path. When an overcurrent condition is detected, the device maintains a constant output current and reduces the output voltage accordingly. Complete shutdown occurs only if the fault stays long enough to activate thermal limiting.

Three possible overload conditions can occur. In the first condition, the output has been shorted to GND before the device is enabled or before V_{IN} has been applied. The AP22815/AP22615 senses the short-circuit and immediately clamps output current to a certain safe level.

In the second condition, an output short or an overload occurs while the device is enabled. At the instance the overload occurs, higher current can flow for a very short period of time before the current limit function can react. After the current limit function has tripped, the device switches into current limiting mode, and the current is clamped at I_{LIMIT} or I_{SHORT} .

In the third condition, the load is gradually increased beyond the recommended operating current. The current is permitted to rise until the current-limit threshold (I_{TRIG}) is reached or until the thermal limit of the device is exceeded. The AP22815/AP22615 is capable of delivering current up to the current-limit threshold without damaging the device. Once the threshold is reached, the device switches into its current limiting mode and is set at I_{LIMIT} .

Thermal Protection

Thermal protection prevents the IC from damage when heavy-overload or short-circuit faults are present for extended periods of time. The AP22815/AP22615 implements a thermal sensing to monitor the operating junction temperature of the power distribution switch. Once the die temperature rises to approximately +140°C due to excessive power dissipation in an overcurrent or short-circuit condition the internal thermal sense circuitry turns the power switch off, thus preventing the power switch from damage. Hysteresis is built into the thermal sense circuit allowing the device to cool down approximately +35°C before the switch turns back on. The switch continues to cycle in this manner until the load fault or input power is removed. The FLG open-drain output is asserted when an overtemperature shutdown or overcurrent occurs with 7ms deglitch.

When V_{IN} operates below 4V, the lower V_{IN} voltage results in higher equivalent R_{ON} and might potentially cause the chip to enter thermal cycling condition by higher output current.

Application Information (continued)

ON/OFF Input Operator

The EN input allows the output current to be switched on and off using a GPIO compatible input. The high signal (switch on) must be at least 1.2V and the low signal (switch off) no higher than 0.4V. This pin should *not* be left floating. It is advisable to hold the EN signal low when applying or removing power.

Undervoltage Lockout (UVLO)

Undervoltage lockout function (UVLO) keeps the internal power switch from being turned on until the power supply has reached at least 2.5V, even if the switch is enabled. Whenever the input voltage falls below approximately 2.3V, the power switch is quickly turned off. This facilitates the design of hot-insertion systems where it is not possible to turn off the power switch before input power is removed.

Discharge Function

The discharge function of the device is active when enable is disabled or de-asserted. The discharge function with the N-MOS power switch implementation is activated and offers a resistive discharge path for the external storage capacitor. This is designed for discharging any residue of the output voltage when either no external output resistance or load resistance is present at the output.

Output Reverse-Voltage/Current Protection

The output reverse-voltage protection turns off the MOSFET switch whenever the output voltage is higher than the input voltage by 65mV, and the MOSFET switch turns on when output reverse-voltage conditions is removed. When reverse-voltage is lower than 65mV, the reverse current is regulated at approximately 350mA. When the reverse current continuously increases and the reverse voltage is larger than 65mV, the reverse-voltage protection is triggered.

Fast Role-Swap Function

The AP22615 & AP22815 integrate the fast role-swap function, which makes V_{OUT} recovery to 4.75V within 150 μ s during V_{OUT} drops from high voltage to low. When EN is high, V_{IN} is valid, and V_{OUT} is higher than V_{IN} by 65 mV, the device works at reverse block mode, power FET is off and standby for FRS. Once V_{OUT} drops lower than V_{IN} , power FET is turned on in 150 μ s.

Power Dissipation and Junction Temperature

The low on-resistance of the internal MOSFET allows the small surface-mount packages to pass large current. Using the maximum operating ambient temperature (T_A) and $R_{DS(ON)}$, the power dissipation can be calculated by:

$$P_D = R_{DS(ON)} \times I^2$$

Finally, calculate the junction temperature:

$$T_J = P_D \times R_{\theta JA} + T_A$$

Where:

- T_A = Ambient temperature °C
- $R_{\theta JA}$ = Thermal resistance
- P_D = Total power dissipation

Board Layout Instruction

Placing input and output capacitors, 1 μ F and 0.1 μ F+100 μ F respectively, close and next to the device pins must be implemented to minimize the effects of parasitic inductance. For best performance, all trace lengths must be kept as short as possible. The input and output PCB traces must be as wide as possible. Use a ground plane to enhance the power dissipation capability of the device.

Ordering Information

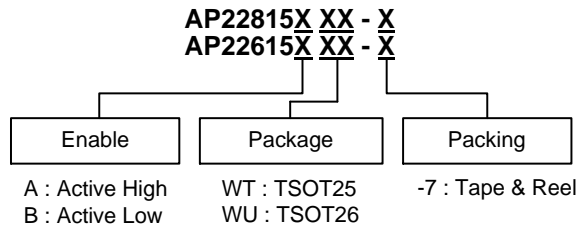

Part Number	Package Code	Packaging	7" Tape and Reel	
			Quantity	Part Number Suffix
AP22815AWT-7	WT	TSOT25	3000/Tape & Reel	-7
AP22815BWT-7	WT	TSOT25	3000/Tape & Reel	-7
AP22615AWU-7	WU	TSOT26	3000/Tape & Reel	-7
AP22615BWU-7	WU	TSOT26	3000/Tape & Reel	-7

Marking Information

(1) TSOT25

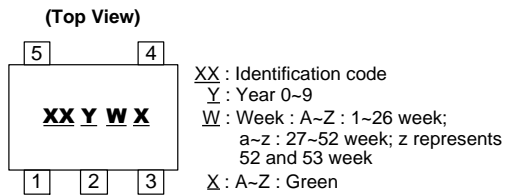

Part Number	Package Type	Identification Code
AP22815AWT-7	TSOT25	P5
AP22815BWT-7	TSOT25	P6

(2) TSOT26

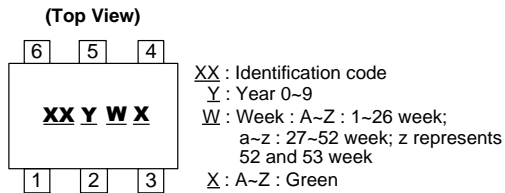

Part Number	Package Type	Identification Code
AP22615AWU-7	TSOT26	P7
AP22615BWU-7	TSOT26	P8

Package Outline Dimensions

Please see <http://www.diodes.com/package-outlines.html> for the latest version.

(1) TSOT25

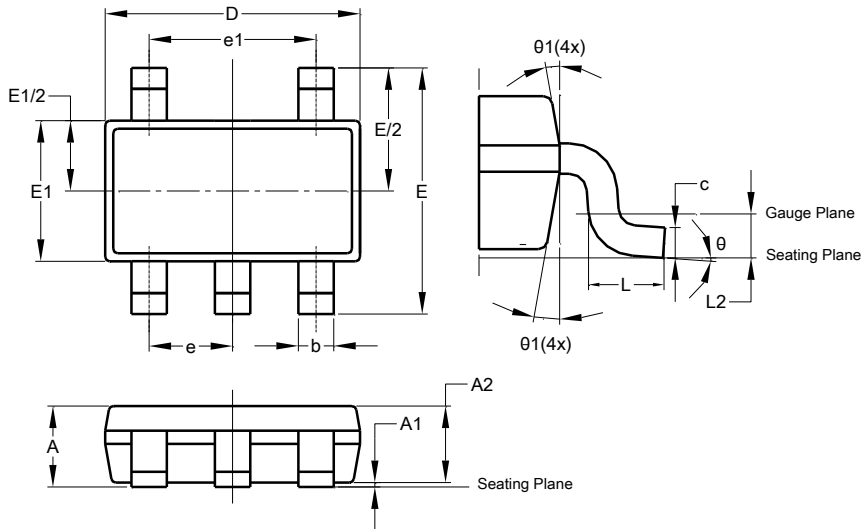

TSOT25			
Dim	Min	Max	Typ
A	-	1.00	-
A1	0.01	0.10	-
A2	0.84	0.90	-
b	0.30	0.45	-
c	0.12	0.20	-
D	-	-	2.90
E	-	-	2.80
E1	-	-	1.60
e	0.95 BSC		
e1	1.90 BSC		
L	0.30	0.50	-
L2	0.25 BSC		
θ	0°	8°	4°
θ1	4°	12°	-
All Dimensions in mm			

(2) TSOT26

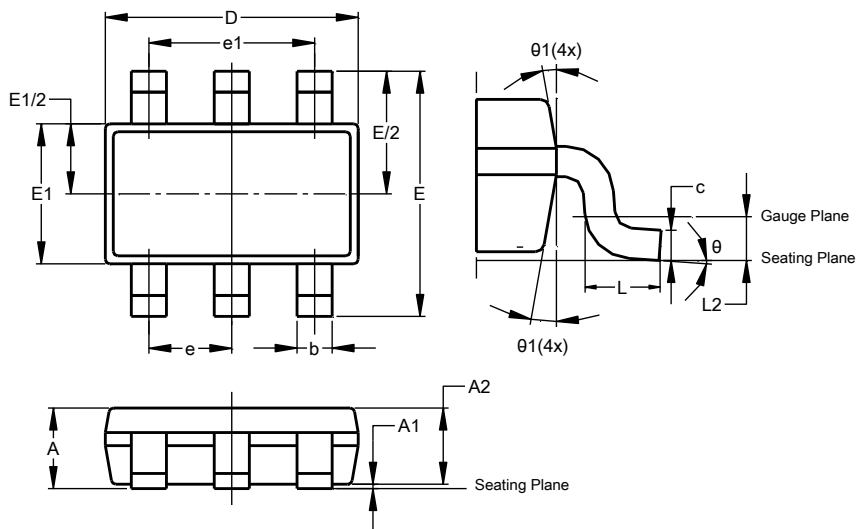

TSOT26			
Dim	Min	Max	Typ
A	-	1.00	-
A1	0.010	0.100	-
A2	0.840	0.900	-
D	2.800	3.000	2.900
E	2.800 BSC		
E1	1.500	1.700	1.600
b	0.300	0.450	-
c	0.120	0.200	-
e	0.950 BSC		
e1	1.900 BSC		
L	0.30	0.50	-
L2	0.250 BSC		
θ	0°	8°	4°
θ1	4°	12°	-
All Dimensions in mm			

Suggested Pad Layout

Please see <http://www.diodes.com/package-outlines.html> for the latest version.

(1) TSOT25

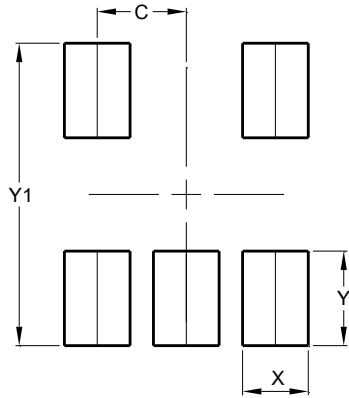

Dimensions	Value (in mm)
C	0.950
X	0.700
Y	1.000
Y1	3.199

(2) TSOT26

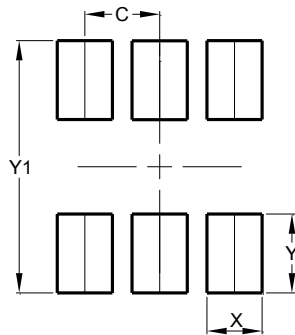

Dimensions	Value (in mm)
C	0.950
X	0.700
Y	1.000
Y1	3.199

IMPORTANT NOTICE

DIODES INCORPORATED MAKES NO WARRANTY OF ANY KIND, EXPRESS OR IMPLIED, WITH REGARDS TO THIS DOCUMENT, INCLUDING, BUT NOT LIMITED TO, THE IMPLIED WARRANTIES OF MERCHANTABILITY AND FITNESS FOR A PARTICULAR PURPOSE (AND THEIR EQUIVALENTS UNDER THE LAWS OF ANY JURISDICTION).

Diodes Incorporated and its subsidiaries reserve the right to make modifications, enhancements, improvements, corrections or other changes without further notice to this document and any product described herein. Diodes Incorporated does not assume any liability arising out of the application or use of this document or any product described herein; neither does Diodes Incorporated convey any license under its patent or trademark rights, nor the rights of others. Any Customer or user of this document or products described herein in such applications shall assume all risks of such use and will agree to hold Diodes Incorporated and all the companies whose products are represented on Diodes Incorporated website, harmless against all damages.

Diodes Incorporated does not warrant or accept any liability whatsoever in respect of any products purchased through unauthorized sales channel. Should Customers purchase or use Diodes Incorporated products for any unintended or unauthorized application, Customers shall indemnify and hold Diodes Incorporated and its representatives harmless against all claims, damages, expenses, and attorney fees arising out of, directly or indirectly, any claim of personal injury or death associated with such unintended or unauthorized application.

Products described herein may be covered by one or more United States, international or foreign patents pending. Product names and markings noted herein may also be covered by one or more United States, international or foreign trademarks.

This document is written in English but may be translated into multiple languages for reference. Only the English version of this document is the final and determinative format released by Diodes Incorporated.

LIFE SUPPORT

Diodes Incorporated products are specifically not authorized for use as critical components in life support devices or systems without the express written approval of the Chief Executive Officer of Diodes Incorporated. As used herein:

A. Life support devices or systems are devices or systems which:

1. are intended to implant into the body, or
2. support or sustain life and whose failure to perform when properly used in accordance with instructions for use provided in the labeling can be reasonably expected to result in significant injury to the user.

B. A critical component is any component in a life support device or system whose failure to perform can be reasonably expected to cause the failure of the life support device or to affect its safety or effectiveness.

Customers represent that they have all necessary expertise in the safety and regulatory ramifications of their life support devices or systems, and acknowledge and agree that they are solely responsible for all legal, regulatory and safety-related requirements concerning their products and any use of Diodes Incorporated products in such safety-critical, life support devices or systems, notwithstanding any devices- or systems-related information or support that may be provided by Diodes Incorporated. Further, Customers must fully indemnify Diodes Incorporated and its representatives against any damages arising out of the use of Diodes Incorporated products in such safety-critical, life support devices or systems.

Copyright © 2019, Diodes Incorporated

www.diodes.com