

NID5001N

Self-Protected FET with Temperature and Current Limit

HDPlus devices are an advanced series of power MOSFETs which utilize ON Semiconductor's latest MOSFET technology process to achieve the lowest possible on-resistance per silicon area while incorporating smart features. Integrated thermal and current limits work together to provide short circuit protection. The devices feature an integrated Drain-to-Gate Clamp that enables them to withstand high energy in the avalanche mode. The Clamp also provides additional safety margin against unexpected voltage transients. Electrostatic Discharge (ESD) protection is provided by an integrated Gate-to-Source Clamp.

Features

- Low $R_{DS(on)}$
- Current Limitation
- Thermal Shutdown with Automatic Restart
- Short Circuit Protection
- I_{DSS} Specified at Elevated Temperature
- Avalanche Energy Specified
- Slew Rate Control for Low Noise Switching
- Overvoltage Clamped Protection
- Pb-Free Package is Available

MAXIMUM RATINGS ($T_J = 25^\circ\text{C}$ unless otherwise noted)

Rating	Symbol	Value	Unit
Drain-to-Source Voltage Internally Clamped	V_{DSS}	42	Vdc
Drain-to-Gate Voltage Internally Clamped ($R_{GS} = 1.0\text{ M}\Omega$)	V_{DGR}	42	Vdc
Gate-to-Source Voltage	V_{GS}	± 14	Vdc
Drain Current – Continuous	I_D	Internally Limited	
Total Power Dissipation @ $T_A = 25^\circ\text{C}$ (Note 1) @ $T_A = 25^\circ\text{C}$ (Note 1) @ $T_A = 25^\circ\text{C}$ (Note 2)	P_D	64 1.0 1.56	W
Thermal Resistance, Junction-to-Case Junction-to-Ambient (Note 1) Junction-to-Ambient (Note 2)	$R_{\theta JC}$ $R_{\theta JA}$ $R_{\theta JA}$	1.95 120 80	$^\circ\text{C}/\text{W}$
Single Pulse Drain-to-Source Avalanche Energy ($V_{DD} = 25\text{ Vdc}$, $V_{GS} = 5.0\text{ Vdc}$, $I_L = 4.5\text{ Apk}$, $L = 120\text{ mH}$, $R_G = 25\ \Omega$)	E_{AS}	1215	mJ
Operating and Storage Temperature Range	T_J , T_{stg}	-55 to 150	$^\circ\text{C}$

Stresses exceeding Maximum Ratings may damage the device. Maximum Ratings are stress ratings only. Functional operation above the Recommended Operating Conditions is not implied. Extended exposure to stresses above the Recommended Operating Conditions may affect device reliability.

1. Minimum FR4 PCB, steady state.
2. Mounted onto a 2" square FR4 board (1" square, 2 oz. Cu 0.06" thick single-sided, $t = \text{steady state}$).



ON Semiconductor®

<http://onsemi.com>

V_{DSS} (Clamped)	$R_{DS(on)}$ TYP	I_D MAX (Limited)
42 V	23 m Ω @ 10 V	33 A*

*Max current may be limited below this value depending on input conditions.

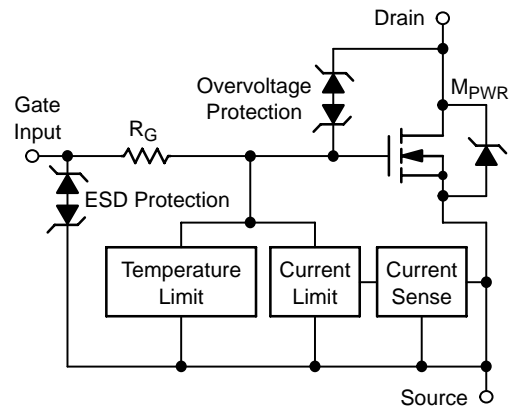

DPAK
CASE 369C
STYLE 2

MARKING DIAGRAM

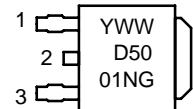

Y = Year
WW = Work Week
D5001N = Device Code
G = Pb-Free Package

1 = Gate
2 = Drain
3 = Source

ORDERING INFORMATION

Device	Package	Shipping†
NID5001NT4	DPAK	2500/Tape & Reel
NID5001NT4G	DPAK (Pb-Free)	2500/Tape & Reel

†For information on tape and reel specifications, including part orientation and tape sizes, please refer to our Tape and Reel Packaging Specification Brochure, BRD8011/D.

NID5001N

MOSFET ELECTRICAL CHARACTERISTICS (T_J = 25°C unless otherwise noted)

Characteristic	Symbol	Min	Typ	Max	Unit
----------------	--------	-----	-----	-----	------

OFF CHARACTERISTICS

Drain-to-Source Clamped Breakdown Voltage (V _{GS} = 0 Vdc, I _D = 250 μAdc) (V _{GS} = 0 Vdc, I _D = 250 μAdc, T _J = 150°C)	V _{(BR)DSS}	42 42	46 44	50 50	Vdc
Zero Gate Voltage Drain Current (V _{DS} = 32 Vdc, V _{GS} = 0 Vdc) (V _{DS} = 32 Vdc, V _{GS} = 0 Vdc, T _J = 150°C)	I _{DSS}		1.5 6.5	5.0	μAdc
Gate Input Current (V _{GS} = 5.0 Vdc, V _{DS} = 0 Vdc)	I _{GSSF}		50	100	μAdc

ON CHARACTERISTICS

Gate Threshold Voltage (V _{DS} = V _{GS} , I _D = 1.2 mAdc) Threshold Temperature Coefficient	V _{GS(th)}	1.0	1.8 5.0	2.0	Vdc -mV/°C
Static Drain-to-Source On-Resistance (Note 3) (V _{GS} = 10 Vdc, I _D = 5.0 Adc, T _J @ 25°C) (V _{GS} = 10 Vdc, I _D = 5.0 Adc, T _J @ 150°C)	R _{DS(on)}		23 43	29 55	mΩ
Static Drain-to-Source On-Resistance (Note 3) (V _{GS} = 5.0 Vdc, I _D = 5.0 Adc, T _J @ 25°C) (V _{GS} = 5.0 Vdc, I _D = 5.0 Adc, T _J @ 150°C)	R _{DS(on)}		28 50	34 60	mΩ
Source-Drain Forward On Voltage (I _S = 5 A, V _{GS} = 0 V)	V _{SD}		0.80	1.1	V

SWITCHING CHARACTERISTICS

Turn-on Time	V _{GS} = 5.0 Vdc, V _{DD} = 25 Vdc I _D = 1.0 Adc, Ext R _G = 2.5 Ω	T _(on)	32	40	μs
Turn-off Time		T _(off)	68	75	
Turn-on Time	V _{GS} = 10 Vdc, V _{DD} = 25 Vdc, I _D = 1.0 Adc, Ext R _G = 2.5 Ω	T _(on)	11	15	
Turn-off Time		T _(off)	86	95	
Slew Rate On	R _L = 4.7 Ω, V _{in} = 0 to 10 V, V _{DD} = 12 V	-dV _{DS} /dt _{on}	0.5		V/μs
Slew-Rate Off	R _L = 4.7 Ω, V _{in} = 10 to 0 V, V _{DD} = 12 V	dV _{DS} /dt _{off}	0.35		V/μs

SELF PROTECTION CHARACTERISTICS (T_J = 25°C unless otherwise noted)

Current Limit	(V _{GS} = 5.0 Vdc) V _{DS} = 10 V (V _{GS} = 5.0 Vdc, T _J = 150°C)	I _{LIM}	21 12	30 19	36 30	Adc
	(V _{GS} = 10 Vdc) V _{DS} = 10 V (V _{GS} = 10 Vdc, T _J = 150°C)		29 13	41 24	49 31	
Temperature Limit (Turn-off)	V _{GS} = 5.0 Vdc	T _{LIM(off)}	150	175	200	°C
Temperature Limit (Circuit Reset)	V _{GS} = 5.0 Vdc	T _{LIM(on)}	135	160	185	°C
Temperature Limit (Turn-off)	V _{GS} = 10 Vdc	T _{LIM(off)}	150	165	185	°C
Temperature Limit (Circuit Reset)	V _{GS} = 10 Vdc	T _{LIM(on)}	135	150	170	°C

ESD ELECTRICAL CHARACTERISTICS (T_J = 25°C unless otherwise noted)

Electro-Static Discharge Capability Human Body Model (HBM) Machine Model (MM)	ESD	4000 400			V
---	-----	-------------	--	--	---

3. Pulse Test: Pulse Width ≤ 300 μs, Duty Cycle ≤ 2%.

TYPICAL PERFORMANCE CURVES

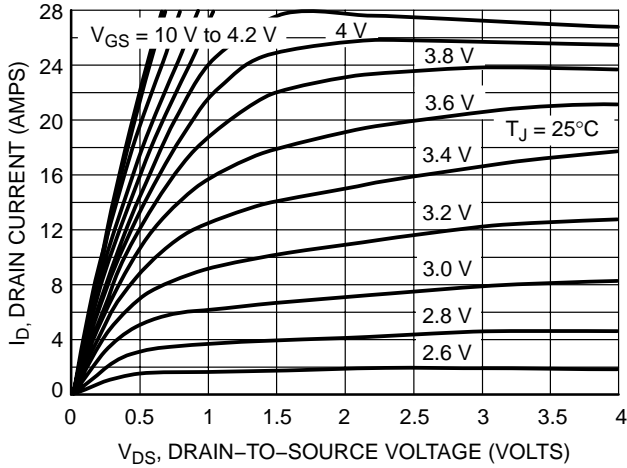

Figure 1. On-Region Characteristics

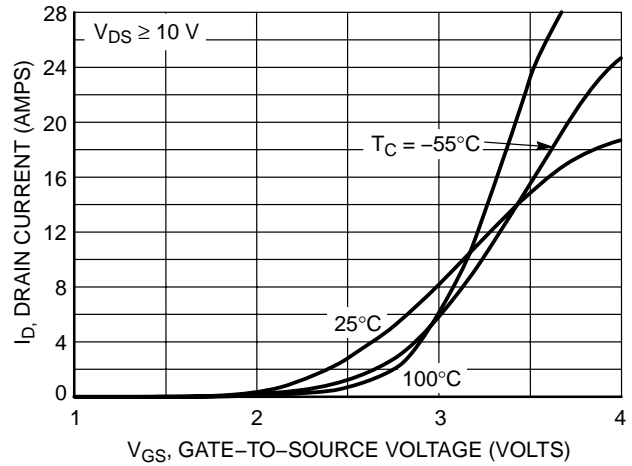

Figure 2. Transfer Characteristics

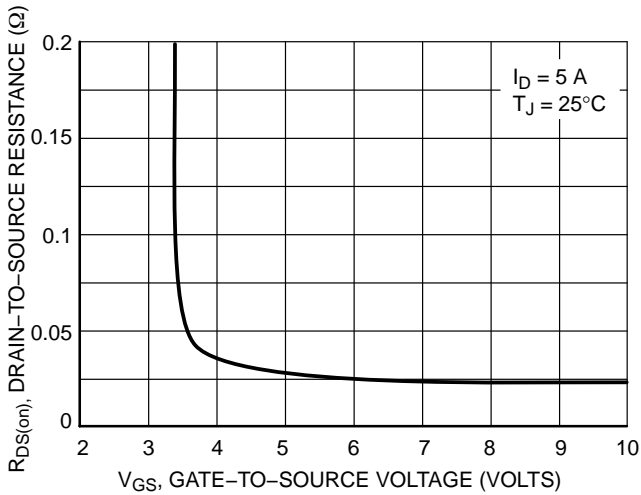

Figure 3. On-Resistance vs. Gate-to-Source Voltage

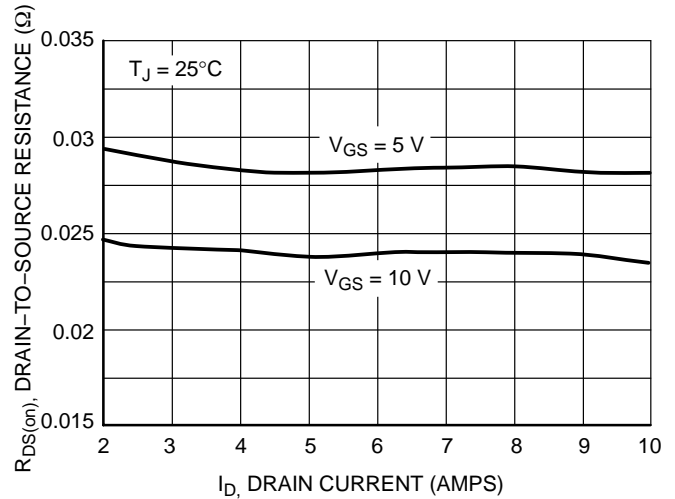

Figure 4. On-Resistance vs. Drain Current and Gate Voltage

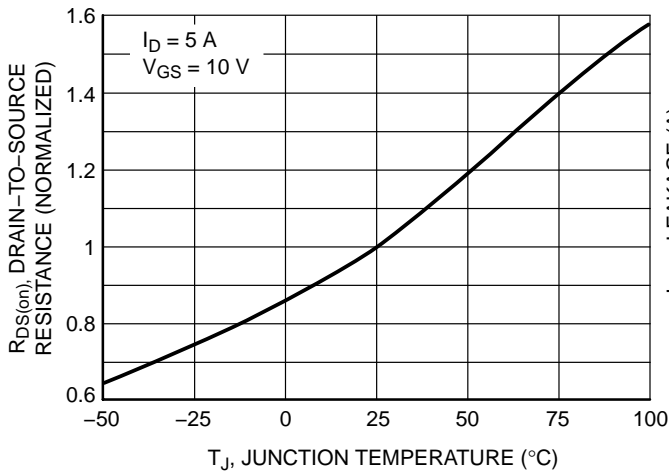

Figure 5. On-Resistance Variation with Temperature

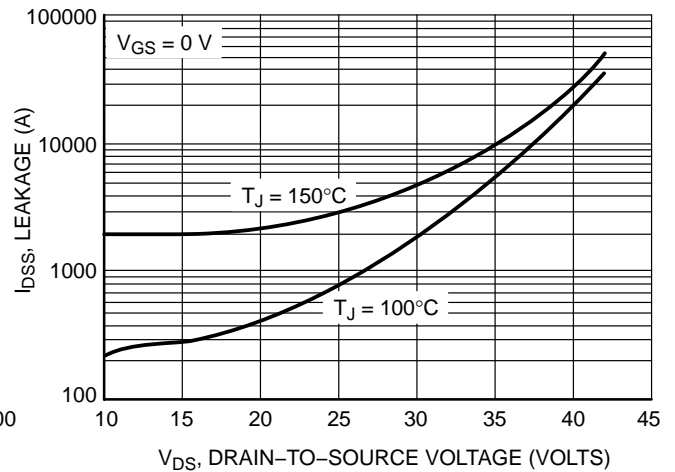

Figure 6. Drain-to-Source Leakage Current vs. Voltage

NID5001N

TYPICAL PERFORMANCE CURVES

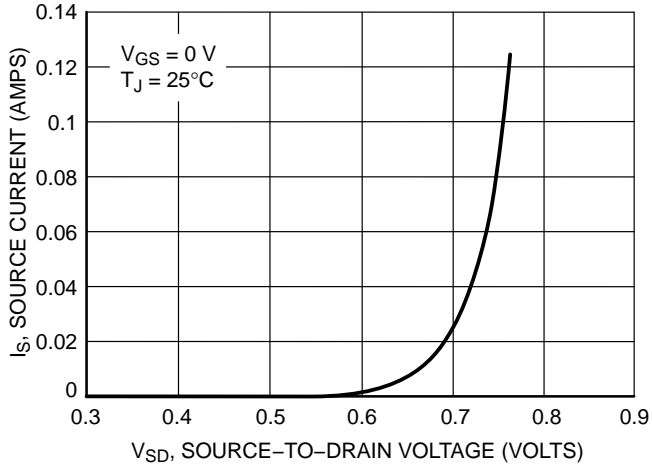

Figure 7. Diode Forward Voltage vs. Current

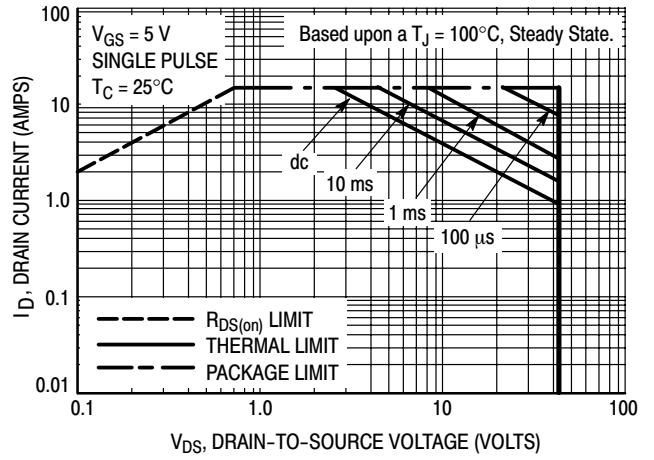

Figure 8. Maximum Rated Forward Biased Safe Operating Area

MECHANICAL CASE OUTLINE PACKAGE DIMENSIONS



DPAK (SINGLE GAUGE) CASE 369C ISSUE F

DATE 21 JUL 2015

SCALE 1:1



NOTES:

1. DIMENSIONING AND TOLERANCING PER ASME Y14.5M, 1994.
2. CONTROLLING DIMENSION: INCHES.
3. THERMAL PAD CONTOUR OPTIONAL WITHIN DIMENSIONS b3, L3 and Z.
4. DIMENSIONS D AND E DO NOT INCLUDE MOLD FLASH, PROTRUSIONS, OR BURRS. MOLD FLASH, PROTRUSIONS, OR GATE BURRS SHALL NOT EXCEED 0.006 INCHES PER SIDE.
5. DIMENSIONS D AND E ARE DETERMINED AT THE OUTERMOST EXTREMES OF THE PLASTIC BODY.
6. DATUMS A AND B ARE DETERMINED AT DATUM PLANE H.
7. OPTIONAL MOLD FEATURE.

DIM	INCHES		MILLIMETERS	
	MIN	MAX	MIN	MAX
A	0.086	0.094	2.18	2.38
A1	0.000	0.005	0.00	0.13
b	0.025	0.035	0.63	0.89
b2	0.028	0.045	0.72	1.14
b3	0.180	0.215	4.57	5.46
c	0.018	0.024	0.46	0.61
c2	0.018	0.024	0.46	0.61
D	0.235	0.245	5.97	6.22
E	0.250	0.265	6.35	6.73
e	0.090	BSC	2.29	BSC
H	0.370	0.410	9.40	10.41
L	0.055	0.070	1.40	1.78
L1	0.114	REF	2.90	REF
L2	0.020	BSC	0.51	BSC
L3	0.035	0.050	0.89	1.27
L4	---	0.040	---	1.01
Z	0.155	---	3.93	---

GENERIC MARKING DIAGRAM*

- | | | | | |
|---|---|--|--|---|
| <p>STYLE 1:
PIN 1. BASE
2. COLLECTOR
3. EMITTER
4. COLLECTOR</p> | <p>STYLE 2:
PIN 1. GATE
2. DRAIN
3. SOURCE
4. DRAIN</p> | <p>STYLE 3:
PIN 1. ANODE
2. CATHODE
3. ANODE
4. CATHODE</p> | <p>STYLE 4:
PIN 1. CATHODE
2. ANODE
3. GATE
4. ANODE</p> | <p>STYLE 5:
PIN 1. GATE
2. ANODE
3. CATHODE
4. ANODE</p> |
| <p>STYLE 6:
PIN 1. MT1
2. MT2
3. GATE
4. MT2</p> | <p>STYLE 7:
PIN 1. GATE
2. COLLECTOR
3. EMITTER
4. COLLECTOR</p> | <p>STYLE 8:
PIN 1. N/C
2. CATHODE
3. ANODE
4. CATHODE</p> | <p>STYLE 9:
PIN 1. ANODE
2. CATHODE
3. RESISTOR ADJUST
4. CATHODE</p> | <p>STYLE 10:
PIN 1. CATHODE
2. ANODE
3. CATHODE
4. ANODE</p> |



- XXXXXX = Device Code
- A = Assembly Location
- L = Wafer Lot
- Y = Year
- WW = Work Week
- G = Pb-Free Package

*This information is generic. Please refer to device data sheet for actual part marking. Pb-Free indicator, "G" or microdot "•", may or may not be present. Some products may not follow the Generic Marking.

SOLDERING FOOTPRINT*



SCALE 3:1 $\left(\frac{\text{mm}}{\text{inches}} \right)$

*For additional information on our Pb-Free strategy and soldering details, please download the ON Semiconductor Soldering and Mounting Techniques Reference Manual, SOLDERRM/D.

DOCUMENT NUMBER:	98AON10527D	Electronic versions are uncontrolled except when accessed directly from the Document Repository. Printed versions are uncontrolled except when stamped "CONTROLLED COPY" in red.
DESCRIPTION:	DPAK (SINGLE GAUGE)	PAGE 1 OF 1

onsemi and ONSEMI are trademarks of Semiconductor Components Industries, LLC dba onsemi or its subsidiaries in the United States and/or other countries. onsemi reserves the right to make changes without further notice to any products herein. onsemi makes no warranty, representation or guarantee regarding the suitability of its products for any particular purpose, nor does onsemi assume any liability arising out of the application or use of any product or circuit, and specifically disclaims any and all liability, including without limitation special, consequential or incidental damages. onsemi does not convey any license under its patent rights nor the rights of others.

onsemi, **Onsemi**, and other names, marks, and brands are registered and/or common law trademarks of Semiconductor Components Industries, LLC dba "**onsemi**" or its affiliates and/or subsidiaries in the United States and/or other countries. **onsemi** owns the rights to a number of patents, trademarks, copyrights, trade secrets, and other intellectual property. A listing of **onsemi**'s product/patent coverage may be accessed at www.onsemi.com/site/pdf/Patent-Marking.pdf. **onsemi** reserves the right to make changes at any time to any products or information herein, without notice. The information herein is provided "as-is" and **onsemi** makes no warranty, representation or guarantee regarding the accuracy of the information, product features, availability, functionality, or suitability of its products for any particular purpose, nor does **onsemi** assume any liability arising out of the application or use of any product or circuit, and specifically disclaims any and all liability, including without limitation special, consequential or incidental damages. Buyer is responsible for its products and applications using **onsemi** products, including compliance with all laws, regulations and safety requirements or standards, regardless of any support or applications information provided by **onsemi**. "Typical" parameters which may be provided in **onsemi** data sheets and/or specifications can and do vary in different applications and actual performance may vary over time. All operating parameters, including "Typicals" must be validated for each customer application by customer's technical experts. **onsemi** does not convey any license under any of its intellectual property rights nor the rights of others. **onsemi** products are not designed, intended, or authorized for use as a critical component in life support systems or any FDA Class 3 medical devices or medical devices with a same or similar classification in a foreign jurisdiction or any devices intended for implantation in the human body. Should Buyer purchase or use **onsemi** products for any such unintended or unauthorized application, Buyer shall indemnify and hold **onsemi** and its officers, employees, subsidiaries, affiliates, and distributors harmless against all claims, costs, damages, and expenses, and reasonable attorney fees arising out of, directly or indirectly, any claim of personal injury or death associated with such unintended or unauthorized use, even if such claim alleges that **onsemi** was negligent regarding the design or manufacture of the part. **onsemi** is an Equal Opportunity/Affirmative Action Employer. This literature is subject to all applicable copyright laws and is not for resale in any manner.

PUBLICATION ORDERING INFORMATION

LITERATURE FULFILLMENT:

Email Requests to: orderlit@onsemi.com

onsemi Website: www.onsemi.com

TECHNICAL SUPPORT

North American Technical Support:

Voice Mail: 1 800-282-9855 Toll Free USA/Canada

Phone: 011 421 33 790 2910

Europe, Middle East and Africa Technical Support:

Phone: 00421 33 790 2910

For additional information, please contact your local Sales Representative