



Is Now Part of



**ON Semiconductor®**

To learn more about ON Semiconductor, please visit our website at  
[www.onsemi.com](http://www.onsemi.com)

Please note: As part of the Fairchild Semiconductor integration, some of the Fairchild orderable part numbers will need to change in order to meet ON Semiconductor's system requirements. Since the ON Semiconductor product management systems do not have the ability to manage part nomenclature that utilizes an underscore (\_), the underscore (\_) in the Fairchild part numbers will be changed to a dash (-). This document may contain device numbers with an underscore (\_). Please check the ON Semiconductor website to verify the updated device numbers. The most current and up-to-date ordering information can be found at [www.onsemi.com](http://www.onsemi.com). Please email any questions regarding the system integration to [Fairchild\\_questions@onsemi.com](mailto:Fairchild_questions@onsemi.com).

ON Semiconductor and the ON Semiconductor logo are trademarks of Semiconductor Components Industries, LLC dba ON Semiconductor or its subsidiaries in the United States and/or other countries. ON Semiconductor owns the rights to a number of patents, trademarks, copyrights, trade secrets, and other intellectual property. A listing of ON Semiconductor's product/patent coverage may be accessed at [www.onsemi.com/site/pdf/Patent-Marking.pdf](http://www.onsemi.com/site/pdf/Patent-Marking.pdf). ON Semiconductor reserves the right to make changes without further notice to any products herein. ON Semiconductor makes no warranty, representation or guarantee regarding the suitability of its products for any particular purpose, nor does ON Semiconductor assume any liability arising out of the application or use of any product or circuit, and specifically disclaims any and all liability, including without limitation special, consequential or incidental damages. Buyer is responsible for its products and applications using ON Semiconductor products, including compliance with all laws, regulations and safety requirements or standards, regardless of any support or applications information provided by ON Semiconductor. "Typical" parameters which may be provided in ON Semiconductor data sheets and/or specifications can and do vary in different applications and actual performance may vary over time. All operating parameters, including "Typicals" must be validated for each customer application by customer's technical experts. ON Semiconductor does not convey any license under its patent rights nor the rights of others. ON Semiconductor products are not designed, intended, or authorized for use as a critical component in life support systems or any FDA Class 3 medical devices or medical devices with a same or similar classification in a foreign jurisdiction or any devices intended for implantation in the human body. Should Buyer purchase or use ON Semiconductor products for any such unintended or unauthorized application, Buyer shall indemnify and hold ON Semiconductor and its officers, employees, subsidiaries, affiliates, and distributors harmless against all claims, costs, damages, and expenses, and reasonable attorney fees arising out of, directly or indirectly, any claim of personal injury or death associated with such unintended or unauthorized use, even if such claim alleges that ON Semiconductor was negligent regarding the design or manufacture of the part. ON Semiconductor is an Equal Opportunity/Affirmative Action Employer. This literature is subject to all applicable copyright laws and is not for resale in any manner.



# FPF34891 / FPF34892 SIDO Over-Voltage Protection Load Switch

## Features

- Single Input Dual Output (SIDO) Switch
  - $V_{BUS}$  to  $V_{OUT}$  Path
  - $V_{BUS}$  to BAT Path
- Surge Protection under IEC 61000-4-5
  - $V_{BUS}$ :  $\pm 100$  V
- Input Voltage Range
  - $V_{BUS}$ : 2.7 V ~ 13.5 V
- Max. Continuous Current Capability
  - $V_{OUT}$  Path: 3.5 A
  - BAT Path: 6 A
- Ultra Low On-Resistance
  - $V_{OUT}$  Path: Typ. 28 m $\Omega$
  - BAT Path: Typ. 33 m $\Omega$
- Selectable OVLO for  $V_{OUT}$  Path
- Programmable OVLO for  $V_{BAT}$
- Over-Voltage Protection (OVP)
  - $V_{OUT}$  Path: 13.9 V  $\pm$  400 mV (FPF34891)
  - $V_{OUT}$  Path: 10.4 V  $\pm$  300 mV (FPF34892)
  - $V_{OUT}$  Path: 5.8 V  $\pm$  200 mV (OVSEL = GND)
  - BAT Path: 5.8 V  $\pm$  200 mV
- Active LOW Control for  $V_{BUS}$  to  $V_{OUT}$  Path
- Active HIGH Control for  $V_{BUS}$  to BAT Path
- CMOS Output PowerGOOD for  $V_{BUS}$  to BAT Path
- RCB for  $V_{BUS}$  to BAT Path
- Over-Temperature Protection (OTP)

## Description

The FPF3489x features a Single Input Dual Output (SIDO) power switch, which offers surge protection and Over-Voltage Protection (OVP), to protect downstream components and enhancing overall system robustness.

Channel one ( $V_{BUS}$  to  $V_{OUT}$ ) is an active-low, 28 V/3.5 A rated, power MOSFET switch with an internal clamp supporting  $\pm 100$  V surge protection, fixed OVP at 5.8V when OVSEL is tied to GND or 13.9V (FPF34891) / 10.4V (FPF34892) when OVSEL is floating.

Channel two ( $V_{BUS}$  to BAT) is an active-high, 5 V/6 A rated, power MOSFET, fixed OVP at  $V_{BUS}$  is 5.8 V ( $\pm 200$  mV) and Reverse Current Blocking (RCB) during its OFF State. OVLO at BAT can be programmed by external resistors. The Over-Voltage status will be latched and FLAG will signal the fault by pulling low. To re-start this channel from OVLO, EN2 need to be toggled from LOW to HIGH.

The FPF3489x is available in a 28-bump, 1.67 mm x 2.96 mm Wafer-Level Chip-Scale Package (WL-CSP) with 0.4 mm pitch.

## Applications

- Mobile Handsets and Tablets
- Wearable Devices

## Ordering Information

Part Number	Operating Temperature Range	Top Mark	Package	Packing Method
FPF34891UCX	-40°C to +85°C	VF	28-Ball, 0.4 mm Pitch WLCSP	Tape & Reel
FPF34892UCX		VG		

### Application Diagram

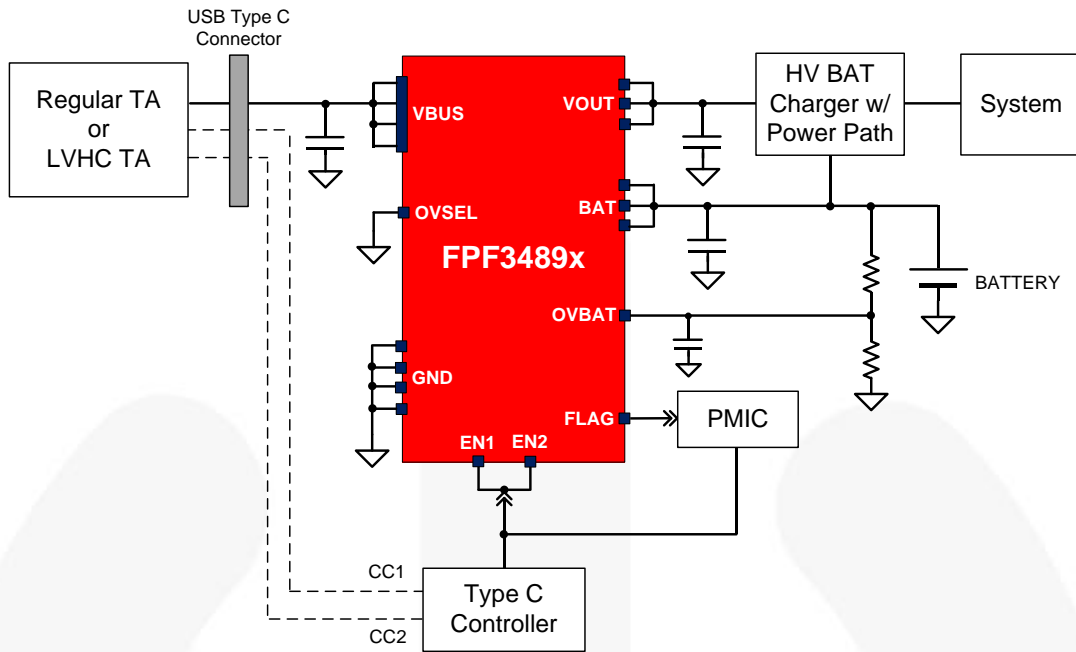

Figure 1. Typical Application

### Block Diagram

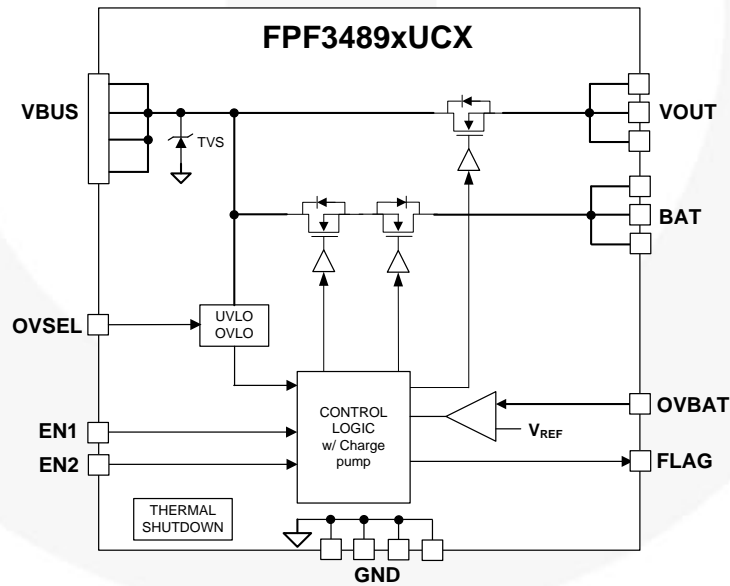

Figure 2. Functional Block Diagram

## Pin Configuration

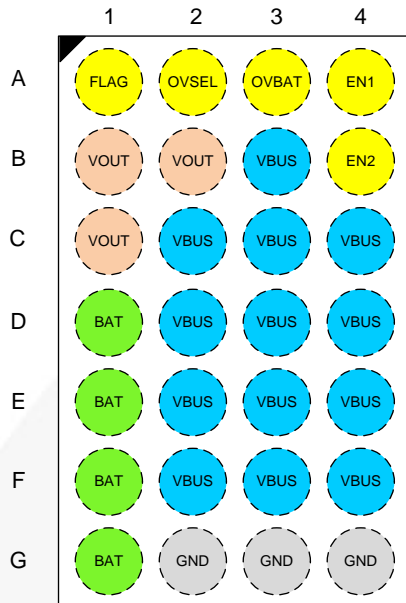

Figure 3. Pin Configuration (Top View)

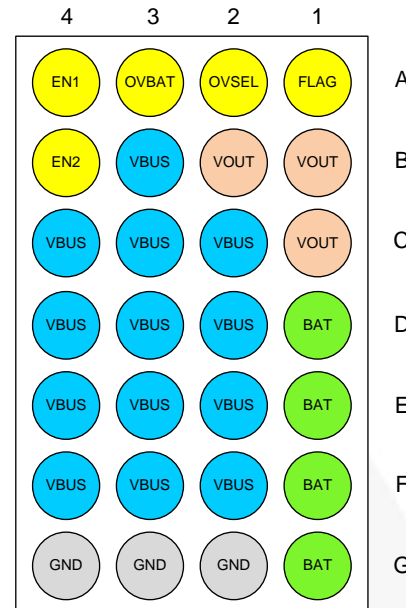

Figure 4. Pin Configuration (Bottom View)

## Pin Definitions

Name	Bump	Type	Description
VBUS	B3, C2, C3, C4, D2, D3, D4, E2, E3, E4, F2, F3, F4	Input/Supply	Power Switch Input and Device Supply
VOUT	B1, B2, C1	Output	Power Switch Output to Load
BAT	D1, E1, F1, G1	Output	Power Switch Output to Battery
OVBAT	A3	Input	Over-Voltage Lockout on BAT Adjustment Pin
EN2	B4	Input	Active HIGH. Channel 2, VBUS to BAT path only. Internal pull-down resistor of 1 MΩ is included.
EN1	A4	Input	Active LOW. Channel 1, VBUS to VOUT path only. Internal pull-down resistor of 1 MΩ is included.
OVSEL	A2	Input	OVSEL Floating, OVP 13.9 V (PPF34891) or 10.4 V (PPF34892); OVSEL = GND, OVP 5.8V.
FLAG	A1	Output	Active HIGH PowerGOOD output for VBUS to BAT path. CMOS output requiring no external bias. HIGH: VBUS to BAT path is ON and in normal state. LOW: VBUS to BAT path is OFF due to EN2=LOW, UVLO, OVLO, thermal shutdown or device shutdown
GND	G2, G3, G4	GND	Ground

## Absolute Maximum Ratings

Stresses exceeding the absolute maximum ratings may damage the device. The device may not function or be operable above the recommended operating conditions and stressing the parts to these levels is not recommended. In addition, extended exposure to stresses above the recommended operating conditions may affect device reliability. The absolute maximum ratings are stress ratings only.

Symbol	Parameters		Min.	Max.	Unit
V <sub>BUS</sub>	VBUS to GND & VBUS to VOUT = GND or Float		-2 <sup>(1)</sup>	28	V
V <sub>OUT</sub>	VOUT to GND		-0.3	V <sub>BUS</sub> +0.3	V
BAT	BAT to GND		-0.3	6.0	V
OVBAT	OVBAT to GND			6	V
V <sub>EN(n)_OVSEL_FLAG</sub>	EN(n), OVSEL or FLAG to GND			6	V
I <sub>IN_VBUS_VOUT</sub>	Continuous VBUS to VOUT Current			3.5	A
	Peak VBUS to VOUT Current (5 ms)			7	A
I <sub>IN_VBUS_BAT</sub>	Continuous VBUS to BAT Current			6	A
	Peak VBUS to BAT Current (5 ms)			12	A
t <sub>PD</sub>	Total Power Dissipation at T <sub>A</sub> =25°C			2.27	W
T <sub>STG</sub>	Storage Junction Temperature		-65	+150	°C
T <sub>J</sub>	Operating Junction Temperature			+150	°C
T <sub>L</sub>	Lead Temperature (Soldering, 10 Seconds)			+260	°C
θ <sub>JA</sub>	Thermal Resistance, Junction-to-Ambient (1in. <sup>2</sup> pad of 2 oz. copper)			55 <sup>(2)</sup>	°C/W
ESD	Electrostatic Discharge Capability	Human Body Model, ANSI/ESDA/JEDEC JS-001	2		kV
		Charged Device Model, JESD22-C101	1		
	IEC61000-4-2 System Level	Air Discharge	15		
		Contact Discharge	8		
Surge	IEC 61000-4-5	V <sub>BUS</sub>	±100		V

### Notes:

1. Pulsed, 50 ms maximum non-repetitive.
2. Measured using 2S2P JEDEC std. PCB.

## Recommended Operating Conditions

The Recommended Operating Conditions table defines the conditions for actual device operation. Recommended operating conditions are specified to ensure optimal performance to the datasheet specifications. Fairchild does not recommend exceeding them or designing to Absolute Maximum Ratings.

Symbol	Parameter	Min.	Max.	Unit
V <sub>BUS</sub>	Supply Voltage	2.7	13.5	V
C <sub>IN</sub> / C <sub>OUT</sub>	Input and Output Capacitance	0.1		μF
C <sub>BAT</sub>	BAT Capacitance	47		μF
T <sub>A</sub>	Operating Temperature	-40	+85	°C

## Electrical Characteristics

Unless otherwise noted,  $V_{BUS} = 2.7$  to  $13.5$  V,  $T_A = -40$  to  $85^\circ\text{C}$ ; Typical values are at  $V_{BUS} = 5$  V,  $I_{IN} \leq 2$  A,  $C_{IN} = 0.1 \mu\text{F}$  and  $T_A = 25^\circ\text{C}$ .

Symbol	Parameter	Conditions	Min.	Typ.	Max.	Unit
<b>Basic Operation</b>						
$I_Q$	Input Quiescent Current	$V_{BUS} = 5$ V, $EN1 = EN2 = \text{LOW}$		145	215	$\mu\text{A}$
$I_{IN\_Q}$	OVLO Supply Current	$V_{BUS} = 15$ V, $V_{OUT} = 0$ V, $EN1 = EN2 = \text{LOW}$		190	290	$\mu\text{A}$
		$V_{BUS} = 5.5$ V, $BAT = 0$ V, $EN1 = EN2 = \text{HIGH}$		150	210	$\mu\text{A}$
$V_{BUS\_CLAMP}$	Input Clamping Voltage	$I_{IN} = 10$ mA		35		V
$V_{BUS\_UVLO}$	Under-Voltage Trip Level	VBUS Rising, $T_A = -40$ to $85^\circ\text{C}$	2.35	2.5	2.65	V
		VBUS Falling, $T_A = -40$ to $85^\circ\text{C}$	2.20	2.35	2.50	V
$T_{SDN}$	Thermal Shutdown <sup>(3)</sup>			150		$^\circ\text{C}$
$T_{SDN\_HYS}$	Thermal Shutdown Hysteresis <sup>(3)</sup>			20		$^\circ\text{C}$
<b>VBUS to VOUT Switch (Channel 1)</b>						
$V_{CH1\_OVP}$	Over-Voltage Trip Level (OVSEL Floating)	VBUS Rising (PPF34891)	13.5	13.9	14.3	V
		VBUS Falling (PPF34891)		13.6		
		VBUS Rising (PPF34892)	10.0	10.4	10.8	
		VBUS Falling (PPF34892)		10.1		
	Over-Voltage Trip Level (OVSEL = GND)	VBUS Rising	5.6	5.8	6.0	
		VBUS Falling		5.65		
$R_{ON\_VOUT}$	On-Resistance	$V_{BUS} = 5$ V, $I_{OUT} = 1$ A, $T_A = 25^\circ\text{C}$		28	39	m $\Omega$
		$V_{BUS} = 12$ V, $I_{OUT} = 1$ A, $T_A = 25^\circ\text{C}$		28	39	m $\Omega$
$t_{DEB\_VOUT}$	Debounce Time	Time from $V_{BUS\_UVLO} < V_{BUS} < V_{BUS\_OVLO}$ to $V_{OUT} = 0.1 \times V_{BUS}$		15		ms
$t_{ON\_VOUT}$	Switch Turn-On Time	$R_L = 100 \Omega$ , $C_L = 10 \mu\text{F}$ , $V_{OUT}$ from $0.1 \times V_{BUS}$ to $0.9 \times V_{BUS}$		2		ms
$t_{OFF\_VOUT}$	Switch Turn-Off Time <sup>(3)</sup>	$R_L = 100 \Omega$ , No $C_L$ , $V_{BUS} > V_{OUT\_OVLO}$ to $V_{OUT} = 0.9 \times V_{BUS}$			150	ns
<b>VBUS to BAT Switch (Channel 2)</b>						
$V_{CH2\_OVP}$	Over-Voltage Trip Level for VBUS monitor	VBUS Rising, $T_A = -40$ to $85^\circ\text{C}$	5.6	5.8	6.0	V
		VBUS Falling, $T_A = -40$ to $85^\circ\text{C}$		5.65		V
$V_{OVLO\_TH}$	BAT OVP set Threshold	$OVBAT = 0$ V to $V_{OVLO}$ , $T_A = 0$ to $85^\circ\text{C}$	1.145	1.155	1.165	V
		$OVBAT = 0$ V to $V_{OVLO}$ , $T_A = -40$ to $85^\circ\text{C}$	1.140	1.155	1.165	
$R_{ON\_BAT}$	On-Resistance	$V_{BUS} = 3$ V, $I_{OUT} = 1$ A, $T_A = 25^\circ\text{C}$		33	40	m $\Omega$
$I_{RCB}$	Reverse Current	$V_{BUS} = 0$ V, $BAT = 4.4$ V			1	$\mu\text{A}$
$t_{DEB\_BAT}$	Debounce Time	Time from $V_{BUS\_UVLO} < V_{BUS} < V_{BUS\_OVLO}$ to $BAT = 0.1 \times V_{BUS}$		15		ms
$t_{BAT\_START}$	Soft-Start Time	Time from $V_{BUS} = V_{BUS\_UVLO}$ to $0.1 \times \text{FLAG}$		30		ms
$t_{ON\_BAT}$	Switch Turn-On Time	$R_L = 100 \Omega$ , $C_L = 10 \mu\text{F}$ , $V_{OUT}$ from $0.1 \times V_{BUS}$ to $0.9 \times V_{BUS}$		2.5		ms

## Electrical Characteristics

Unless otherwise noted,  $V_{BUS} = 2.7$  to  $13.5$  V,  $T_A = -40$  to  $85^\circ\text{C}$ ; Typical values are at  $V_{BUS} = 5$  V,  $I_{IN} \leq 2$  A,  $C_{IN} = 0.1\ \mu\text{F}$  and  $T_A = 25^\circ\text{C}$ .

Symbol	Parameter	Conditions	Min.	Typ.	Max.	Unit
$t_{\text{OFF\_BAT}}$	Switch Turn-Off Time <sup>(3)</sup>	$R_L = 100\ \Omega$ , No $C_L$ , $V_{BUS} > V_{\text{BAT\_OV\text{BAT}}} \text{ to } \text{BAT} = 0.9 \times V_{BUS}$			150	ns
<b>Digital Signals</b>						
$V_{\text{OH}}$	FLAG Output HIGH Voltage	$V_{BUS} = 5$ V, $\text{EN}2 = \text{LOW}$	1.6	1.8	2.0	V
$V_{\text{OL}}$	FLAG Output LOW Voltage	$V_{BUS} = 5$ V, $\text{EN}2 = \text{HIGH}$			0.5	V
$R_{\text{PD\_EN}(n)}$	Internal Pull-Down Resistor at $\text{EN}1$ and $\text{EN}2$			1		$\text{M}\Omega$
$R_{\text{PU\_OVSEL}}$	Internal Pull-Up Resistor at $\text{OVSEL}$			1		$\text{M}\Omega$
$V_{\text{IH\_EN}(n)\_OVSEL}$	Logic Enable HIGH Voltage	$V_{BUS}$ Operating Range	1.2			V
$V_{\text{IL\_EN}(n)\_OVSEL}$	Logic Enable LOW Voltage	$V_{BUS}$ Operating Range			0.5	V
$I_{\text{OVSEL\_EN}(n)\_LEAK}$	$\text{OVSEL}$ and $\text{EN}(n)$ Leakage Current	$V_{BUS} = 5$ V, $V_{\text{OUT}}$ , $\text{BAT} = \text{Floating}$		5	7	$\mu\text{A}$

### Note:

- Guaranteed by characterization and design.

## Timing Diagrams

### VBUS to VOUT Path

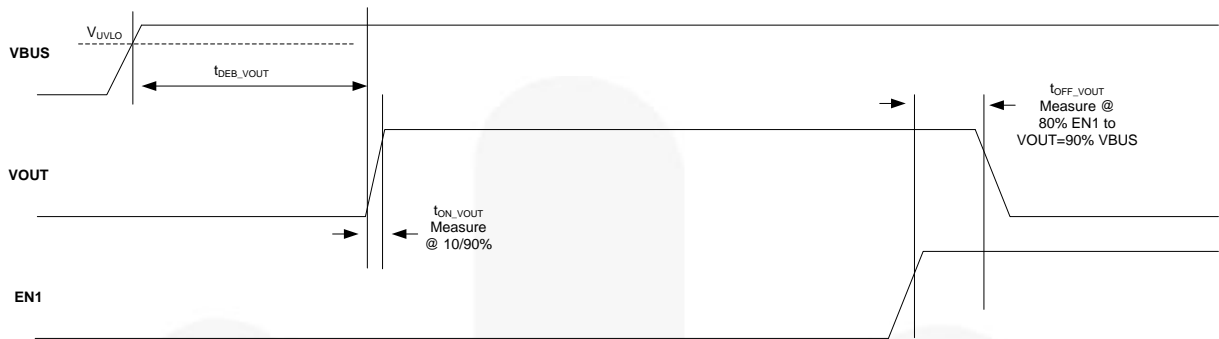

Figure 5. Timing for VBUS to VOUT Power Up/Down and Normal Operation

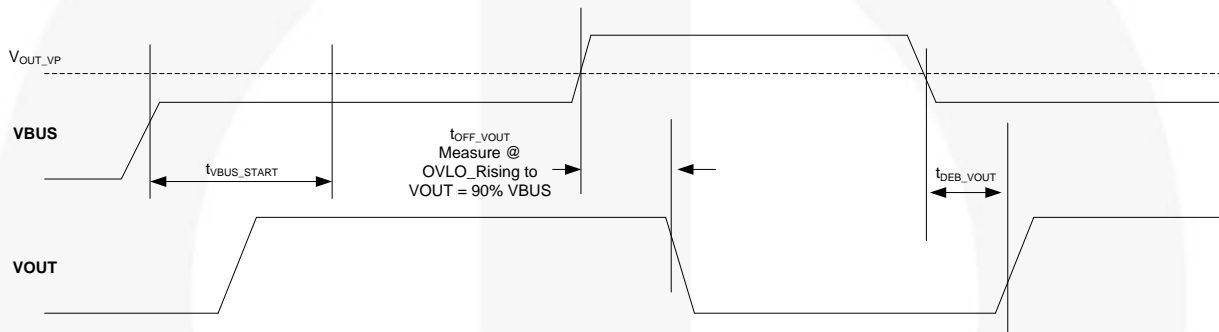

Figure 6. Timing for VBUS to VOUT OVLO Operation (EN1=LOW)

### VBUS to BAT Path

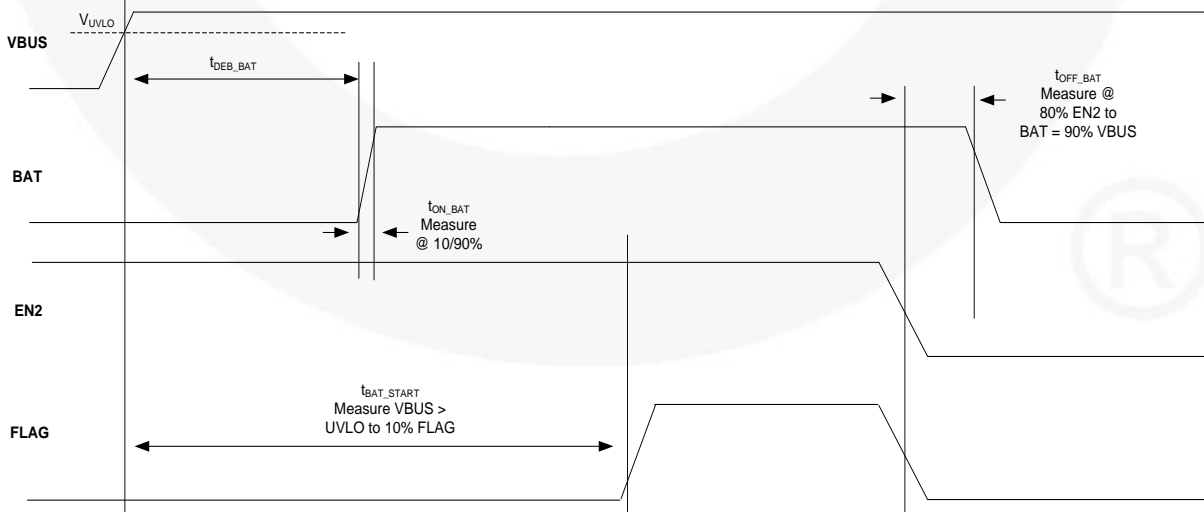

Figure 7. Timing for VBUS to BAT Power Up/Down and Normal Operation



Timing Diagrams (Continued)

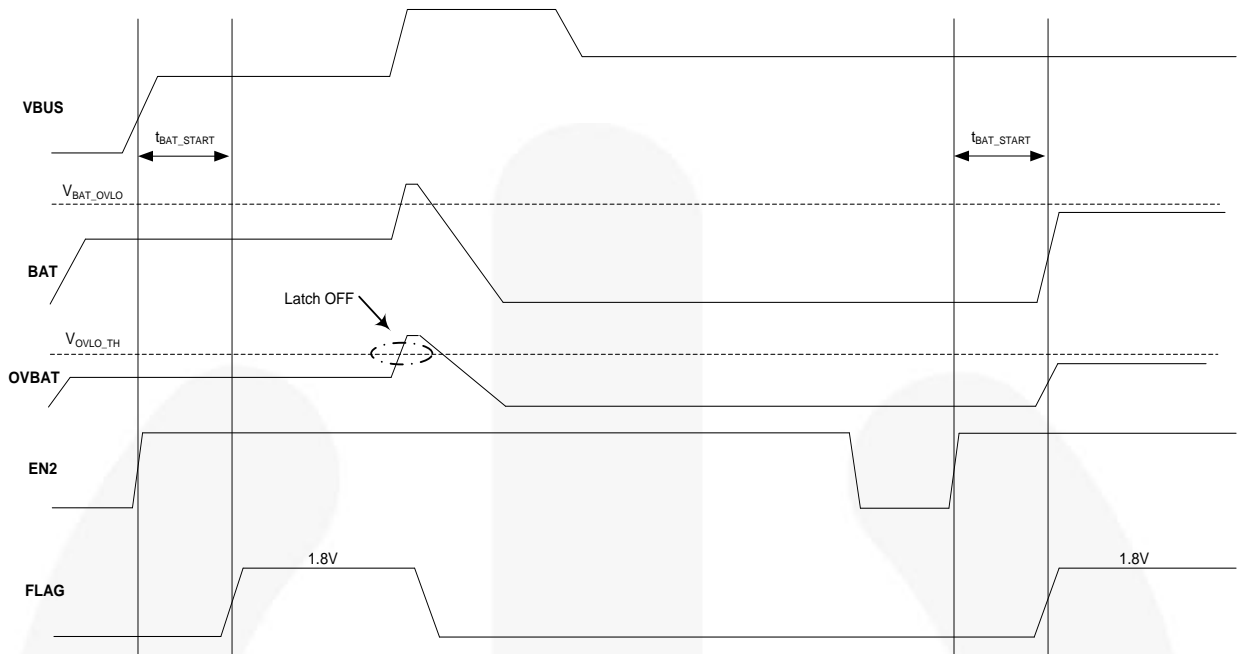

Figure 8. Timing for VBUS to BAT OVLO Operation (EN2=HIGH)

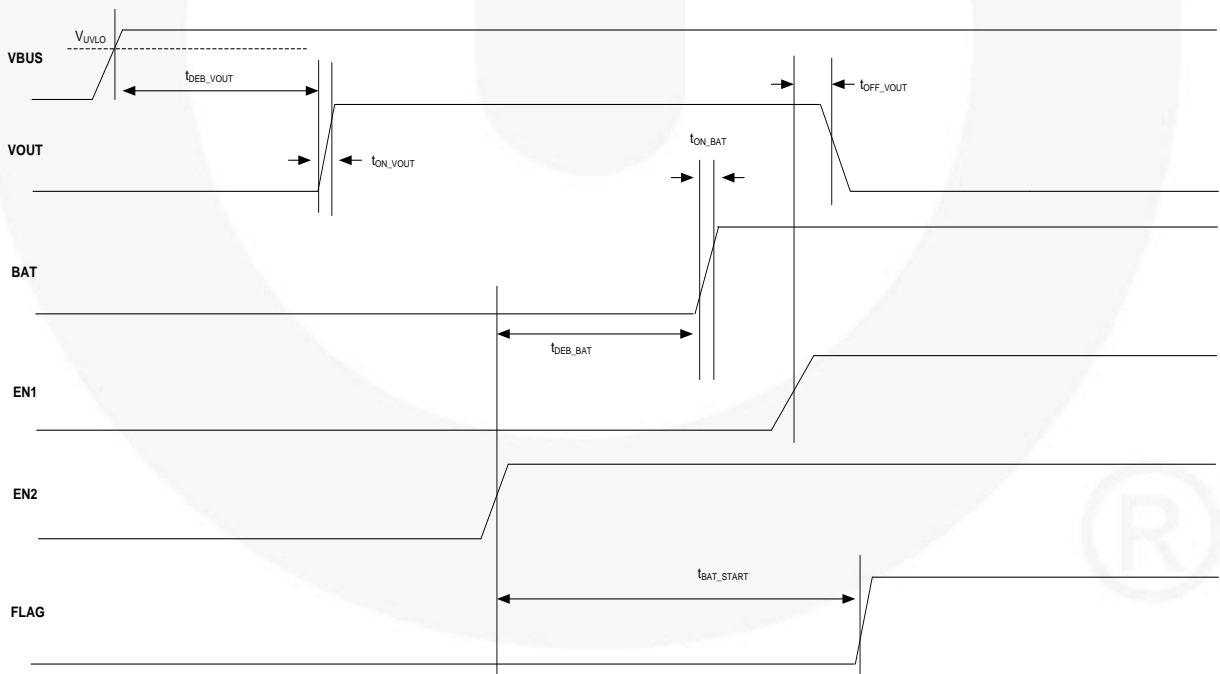

Figure 9. Timing for Overall ON/OFF Operation

## Operation and Application Description

### Input Capacitor

To limit the voltage drop on the input supply caused by transient inrush current when the switches turns, a capacitor must be placed in between the VBUS and GND pins. A high-value capacitor on  $C_{IN}$  can be used to reduce the voltage drop in high-current applications.

### Under-Voltage Lockout (UVLO)

The under-voltage lockout turns the switches off if the input voltage drops below the lockout threshold. With the enable pins, EN1 & EN2, active, the input voltage rising above the UVLO threshold releases the lockout and enables the switches.

### Thermal Shutdown

The thermal shutdown protects the die from internally or externally generated excessive temperature. During an over-temperature condition, the switch is turned off. The switch automatically turns on again if the temperature of the die drops below the threshold temperature.

### FLAG Reporting

To indicate the status of channel 2, push-pull output FLAG signal high (typical 1.8V) when channel 2 is turned on. FLAG will output low when channel 2 is turned off.

### Over-Voltage Lockout

To protect the system, FPF3489x provide multi level over voltage protection.

For channel 1 (VBUS to VOUT), 3 different levels can be chosen. When OVSEL is tied to GND, OVP will be triggered once VBUS voltage is higher than typical 5.8V. With OVSEL floating, OVP will be triggered when VBUS voltage is higher than typical 13.9V (FPF34891) or 10.4V (FPF34892). FLAG voltage will output low until the over voltage condition disappears.

For channel 2 (VBUS to BAT), both VBUS and BAT voltage will be monitored. Once VBUS voltage is higher than typical 5.8V, channel 2 will be turned off and output low at FLAG pin until VBUS drop below 5.65V (typical). Once BAT voltage is higher than pre-set value (set by external resistors), channel 2 will be turned off and output low at FLAG pin. This status will be latched even after BAT voltage drop to lower than OVP value. To re-active the switch, EN2 need to be toggled.

The OVLO level on BAT can be pre-set by connecting external resistor ladder to the OVBAT pin. Equation (1) can produce the desired trip voltage and resistor values.

$$V_{BAT\_OVLO} = V_{OVLO\_TH} \times [1 + R1/R2] \quad (1)$$

Recommended minimum  $R1 = 1 \text{ M}\Omega$  to reduce leakage and screen unexpected glitch.

The following information applies to the WL-CSP package dimensions on the next page:

### Product-Specific Dimensions

D	E	X	Y
2960 $\mu\text{m} \pm 30 \mu\text{m}$	1670 $\mu\text{m} \pm 30 \mu\text{m}$	235 $\mu\text{m} \pm 18 \mu\text{m}$	280 $\mu\text{m} \pm 18 \mu\text{m}$

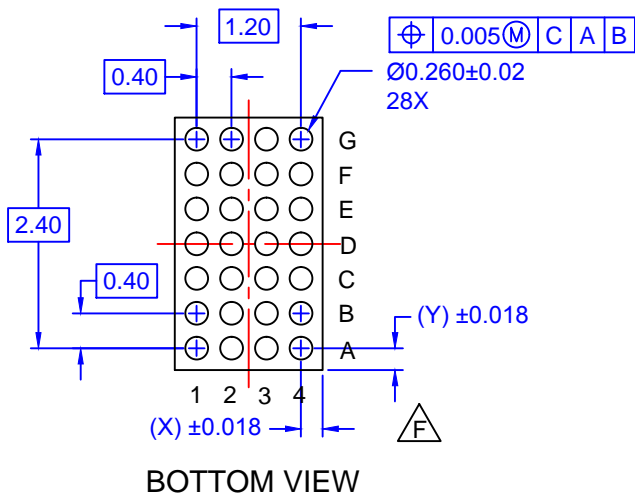
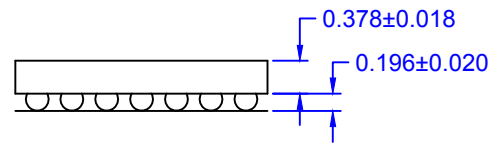
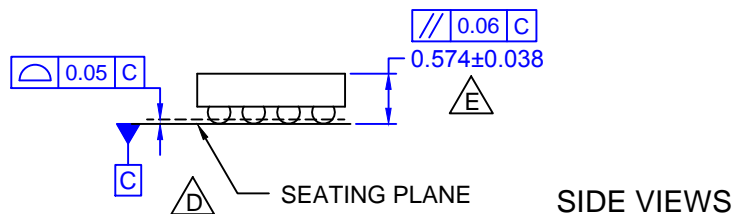
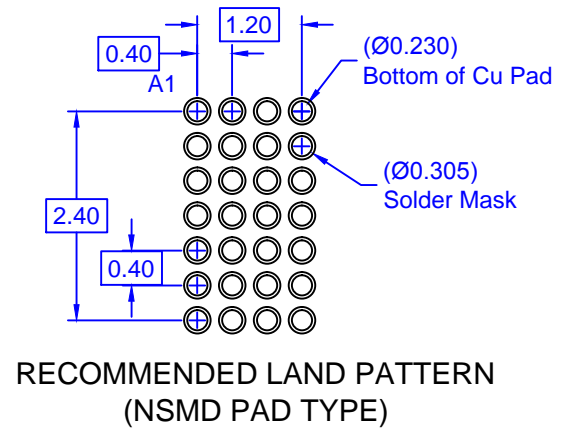
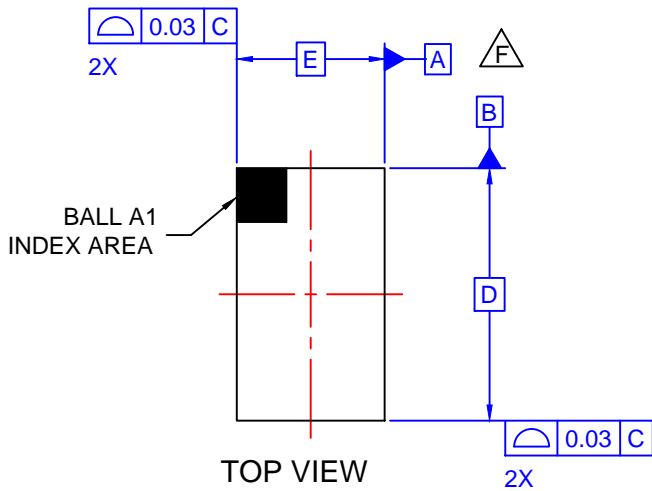

NOTES

- A. NO JEDEC REGISTRATION APPLIES.
- B. DIMENSIONS ARE IN MILLIMETERS.
- C. DIMENSIONS AND TOLERANCE PER ASMEY14.5M, 2009.
- D. DATUM C IS DEFINED BY THE SPHERICAL CROWNS OF THE BALLS.
- E. PACKAGE NOMINAL HEIGHT IS 574 ± 38 MICRONS (536-612 MICRONS).
- F. FOR DIMENSIONS D, E, X, AND Y SEE PRODUCT DATASHEET.
- G. DRAWING FILENAME: MKT-UC028AB REV1.



ON Semiconductor and  are trademarks of Semiconductor Components Industries, LLC dba ON Semiconductor or its subsidiaries in the United States and/or other countries. ON Semiconductor owns the rights to a number of patents, trademarks, copyrights, trade secrets, and other intellectual property. A listing of ON Semiconductor's product/patent coverage may be accessed at [www.onsemi.com/site/pdf/Patent-Marking.pdf](http://www.onsemi.com/site/pdf/Patent-Marking.pdf). ON Semiconductor reserves the right to make changes without further notice to any products herein. ON Semiconductor makes no warranty, representation or guarantee regarding the suitability of its products for any particular purpose, nor does ON Semiconductor assume any liability arising out of the application or use of any product or circuit, and specifically disclaims any and all liability, including without limitation special, consequential or incidental damages. Buyer is responsible for its products and applications using ON Semiconductor products, including compliance with all laws, regulations and safety requirements or standards, regardless of any support or applications information provided by ON Semiconductor. "Typical" parameters which may be provided in ON Semiconductor data sheets and/or specifications can and do vary in different applications and actual performance may vary over time. All operating parameters, including "Typicals" must be validated for each customer application by customer's technical experts. ON Semiconductor does not convey any license under its patent rights nor the rights of others. ON Semiconductor products are not designed, intended, or authorized for use as a critical component in life support systems or any FDA Class 3 medical devices or medical devices with a same or similar classification in a foreign jurisdiction or any devices intended for implantation in the human body. Should Buyer purchase or use ON Semiconductor products for any such unintended or unauthorized application, Buyer shall indemnify and hold ON Semiconductor and its officers, employees, subsidiaries, affiliates, and distributors harmless against all claims, costs, damages, and expenses, and reasonable attorney fees arising out of, directly or indirectly, any claim of personal injury or death associated with such unintended or unauthorized use, even if such claim alleges that ON Semiconductor was negligent regarding the design or manufacture of the part. ON Semiconductor is an Equal Opportunity/Affirmative Action Employer. This literature is subject to all applicable copyright laws and is not for resale in any manner.

## PUBLICATION ORDERING INFORMATION

### LITERATURE FULFILLMENT:

Literature Distribution Center for ON Semiconductor  
19521 E. 32nd Pkwy, Aurora, Colorado 80011 USA  
**Phone:** 303-675-2175 or 800-344-3860 Toll Free USA/Canada  
**Fax:** 303-675-2176 or 800-344-3867 Toll Free USA/Canada  
**Email:** [orderlit@onsemi.com](mailto:orderlit@onsemi.com)

**N. American Technical Support:** 800-282-9855 Toll Free  
USA/Canada  
**Europe, Middle East and Africa Technical Support:**  
Phone: 421 33 790 2910  
**Japan Customer Focus Center**  
Phone: 81-3-5817-1050

**ON Semiconductor Website:** [www.onsemi.com](http://www.onsemi.com)  
**Order Literature:** <http://www.onsemi.com/orderlit>  
For additional information, please contact your local  
Sales Representative