

0.8 V to 2.5 V, 28 mΩ, Slew Rate Controlled Load Switch in WCSP4

DESCRIPTION

The SiP32454 and SiP32455 are slew rate controlled integrated high side load switches that operate in the input voltage range from 0.8 V to 2.5 V. The SiP32454 and SiP32455 are of n-channel MOSFET switching elements that provide 28 mΩ switch on resistance. They have a 1 ms at 1.2 V and 1.5 ms at 2.5 V slow slew rate that limits the in-rush current and minimizes the switching noise. These devices' low voltage logic control threshold can interface with low voltage control I/O directly without extra level shift or driver. A 2 MW pull-down resistor is integrated at logic control EN pin. SiP32454 integrates a switch off output discharge circuit.

Both SiP32454 and SiP32455 are available in compact wafer level CSP package, WCSP4 0.8 mm x 0.8 mm with 0.4 mm pitch.

FEATURES

- Low input voltage, 0.8 V to 2.5 V
- Low R_{ON} , 28 mΩ typical
- Slew rate control
- Low logic control with hysteresis
- Reverse current blocking when disabled
- Integrated output discharge switch for SiP32454
- Integrated pull down resistor at EN pin
- 4 bump WCSP 0.8 mm x 0.8 mm with 0.4 mm pitch package
- Material categorization: for definitions of compliance please see www.vishay.com/doc?99912



APPLICATIONS

- Battery operated devices
- Smart phones
- GPS and PMP
- Computer
- Medical and healthcare equipment
- Industrial and instrument
- Cellular phones and portable media players
- Game consol

TYPICAL APPLICATION CIRCUIT

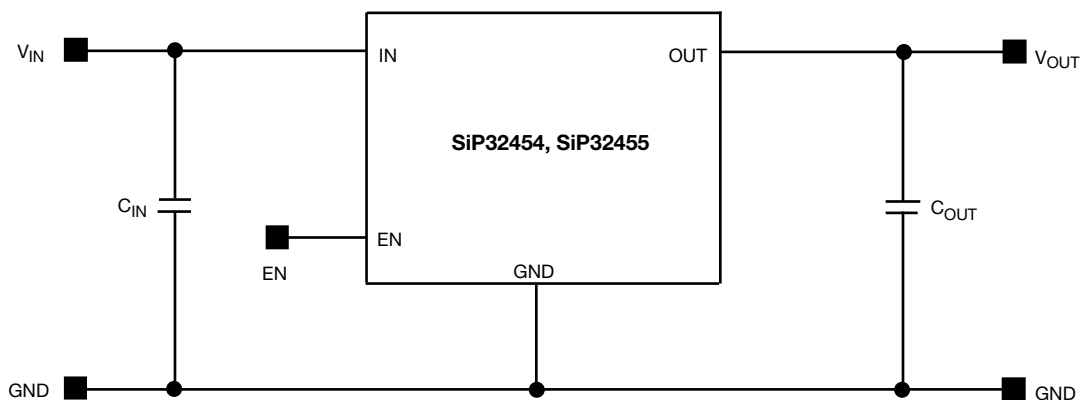

Fig. 1 - SiP32454 and SiP32455 Typical Application Circuit

| ORDERING INFORMATION | | | |
|----------------------|---|---------|-------------------|
| TEMPERATURE RANGE | PACKAGE | MARKING | PART NUMBER |
| -40 °C to +85 °C | WCSP: 4 bumps (2 x 2, 0.4 mm pitch, 208 μm bump height, 0.8 mm x 0.8 mm die size) | AD | SiP32454DB-T2-GE1 |
| | | AE | SiP32455DB-T2-GE1 |

Note

- -GE1 denotes halogen-free and RoHS-compliant



| ABSOLUTE MAXIMUM RATINGS | | |
|---|--------------|------|
| PARAMETER | LIMIT | UNIT |
| Supply input voltage (V_{IN}) | -0.3 to 2.75 | V |
| Enable input voltage (V_{EN}) | -0.3 to 2.75 | |
| Output voltage (V_{OUT}) | -0.3 to 2.75 | |
| Maximum continuous switch current ($I_{max.}$) | 1.2 | A |
| Maximum repetitive pulsed current (I_{DM}) V_{IN} (pulsed at 1 ms, 10 % duty cycle) | 2 | |
| ESD rating (HBM) | 4000 | V |
| Junction temperature (T_J) | -40 to +150 | °C |
| Thermal resistance (θ_{JA}) ^a | 280 | °C/W |
| Power dissipation (P_D) ^a | 196 | mW |

Notes

- a. Device mounted with all leads and power pad soldered or welded to PC board, see PCB layout
- b. Derate 3.6 mW/°C above $T_A = 25$ °C

Stresses beyond those listed under “Absolute Maximum Ratings” may cause permanent damage to the device. These are stress ratings only, and functional operation of the device at these or any other conditions beyond those indicated in the operational sections of the specifications is not implied. Exposure to absolute maximum rating/conditions for extended periods may affect device reliability.

| RECOMMENDED OPERATING RANGE | | |
|--|-------------|------|
| PARAMETER | LIMIT | UNIT |
| Input voltage range (V_{IN}) | 0.8 to 2.5 | V |
| Operating junction temperature range (T_J) | -40 to +125 | °C |

| SPECIFICATIONS | | | | | | |
|------------------------------------|---------------|---|-------------------|-------------------|-------------------|--------|
| PARAMETER | SYMBOL | TEST CONDITIONS UNLESS SPECIFIED $V_{IN} = 1$ V, $T_A = -40$ °C to +85 °C (typical values are at $T_A = 25$ °C) | LIMITS | | | UNIT |
| | | | MIN. ^a | TYP. ^b | MAX. ^a | |
| Operating voltage ^c | V_{IN} | | 0.8 | - | 2.5 | V |
| Quiescent current | I_Q | $V_{IN} = 1.2$ V, $V_{EN} = V_{IN}$, OUT = open | - | 10 | 15 | μA |
| | | $V_{IN} = 2.5$ V, $V_{EN} = V_{IN}$, OUT = open | - | 34 | 60 | |
| Off supply current | $I_{Q(off)}$ | SiP32454 | - | - | 30 | μA |
| | | SiP32455 | - | - | 1 | |
| Off switch current | $I_{DS(off)}$ | EN = GND, OUT = 0 V | - | - | 30 | |
| Reverse blocking current | I_{RB} | $V_{OUT} = 2.5$ V, $V_{IN} = 0.9$ V, $V_{EN} = 0$ V | - | 0.001 | 30 | |
| On-resistance | $R_{DS(on)}$ | $V_{IN} = 1$ V, $I_L = 200$ mA, $T_A = 25$ °C | - | 30 | 35 | mΩ |
| | | $V_{IN} = 1.2$ V, $I_L = 200$ mA, $T_A = 25$ °C | - | 29 | 35 | |
| | | $V_{IN} = 1.8$ V, $I_L = 200$ mA, $T_A = 25$ °C | - | 28 | 35 | |
| | | $V_{IN} = 2.5$ V, $I_L = 200$ mA, $T_A = 25$ °C | - | 28 | 35 | |
| On-resistance temp. coefficient | TC_{RDS} | | - | 4100 | - | ppm/°C |
| Output pull-down resistance | R_{PD} | $V_{EN} = 0$ V, $T_A = 25$ °C (SiP32454 only) | - | 417 | 550 | Ω |
| EN input low voltage ^c | V_{IL} | $V_{IN} = 1$ V | - | - | 0.1 | V |
| EN input high voltage ^c | V_{IH} | $V_{IN} = 2.5$ V | 1.5 | - | - | V |
| EN input leakage | I_{EN} | $V_{IN} = 2.5$ V, $V_{EN} = 0$ V | - | - | 1 | μA |
| | | $V_{IN} = 2.5$ V, $V_{EN} = 2.5$ V | - | 6.5 | 12 | |
| Output turn-on delay time | $t_{d(on)}$ | $V_{IN} = 1.2$ V | - | 0.6 | 1.2 | ms |
| | | $V_{IN} = 2.5$ V | - | 0.6 | 1.2 | |
| Output turn-on rise time | t_r | $V_{IN} = 1.2$ V | 0.4 | 1 | 1.6 | ms |
| | | $V_{IN} = 2.5$ V | 0.5 | 1.5 | 2.5 | |
| Output turn-off delay time | $t_{d(off)}$ | $V_{IN} = 1.2$ V | - | 0.3 | 1 | μs |
| | | $V_{IN} = 2.5$ V | - | 0.1 | 1 | |

Notes

- a. The algebraic convention whereby the most negative value is a minimum and the most positive a maximum
- b. Typical values are for DESIGN AID ONLY, not guaranteed nor subject to production testing
- c. For V_{IN} outside this range consult typical EN threshold curve

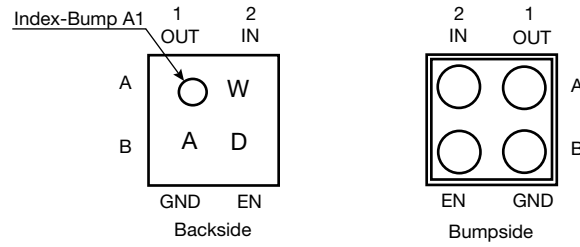
PIN CONFIGURATION

Fig. 2 - WCSP 2 x 2 Package

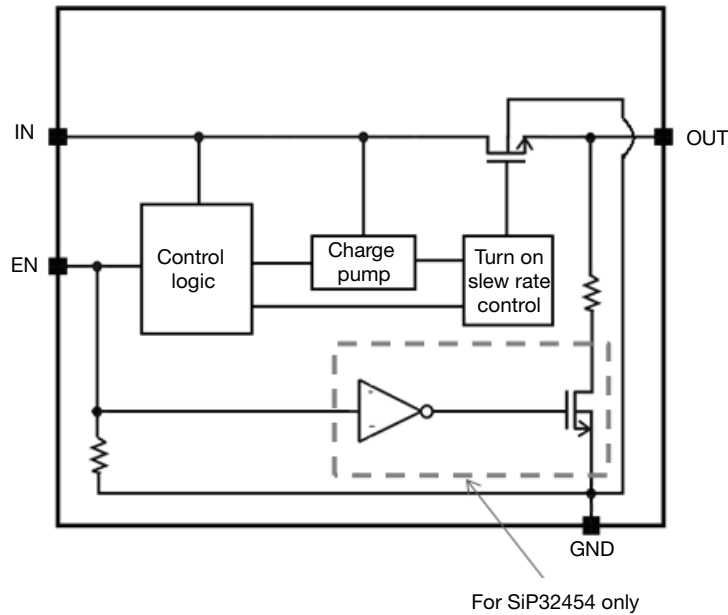
| PIN DESCRIPTION | | |
|-----------------|------|--------------------------------------|
| PIN NUMBER | NAME | FUNCTION |
| A1 | OUT | This is the output pin of the switch |
| A2 | IN | This is the input pin of the switch |
| B1 | GND | Ground connection |
| B2 | EN | Enable input |

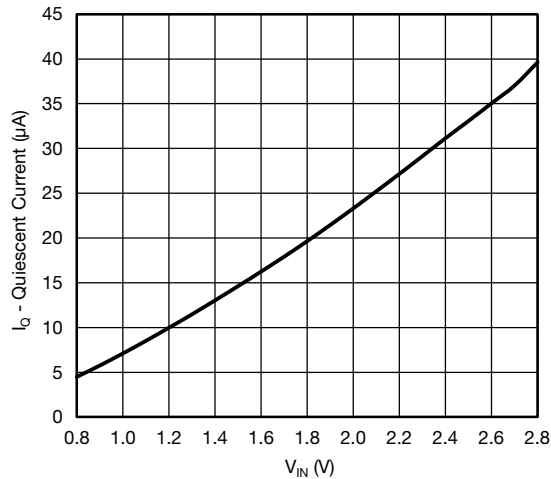
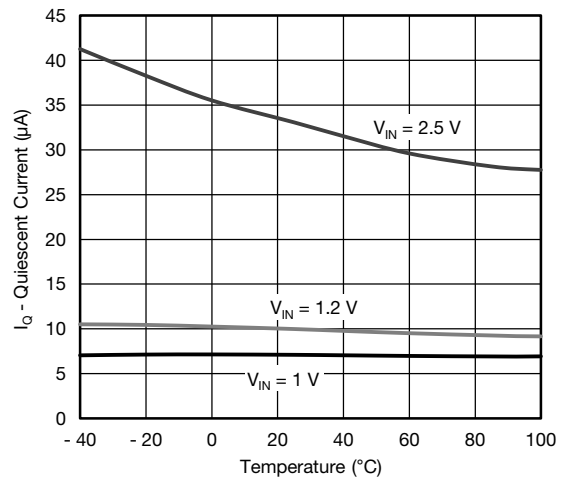
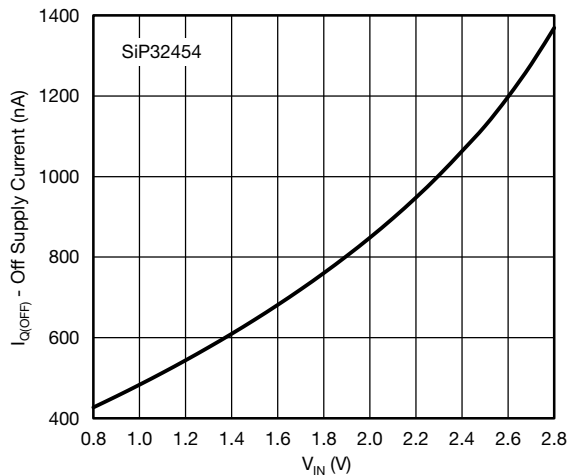
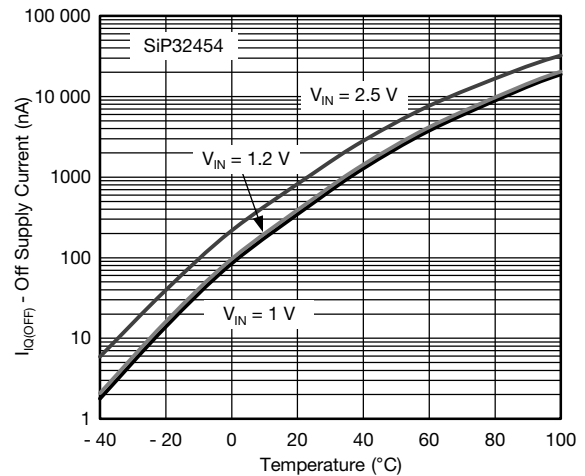
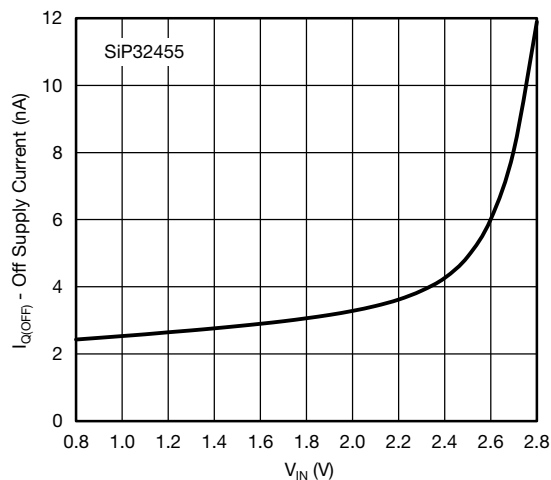
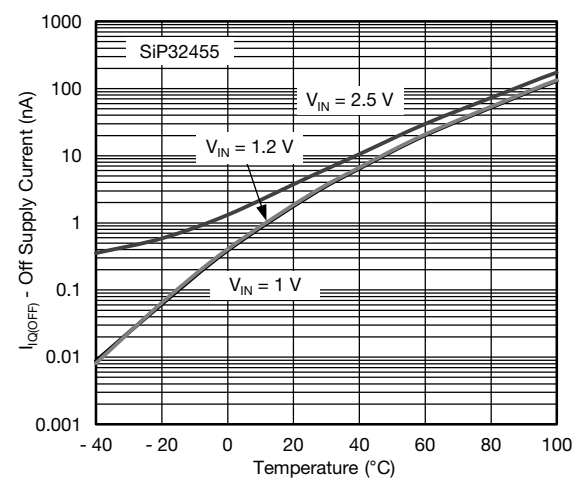
BLOCK DIAGRAM

Fig. 3 - Functional Block Diagram

TYPICAL CHARACTERISTICS (internally regulated, 25 °C, unless otherwise noted)

Fig. 4 - Quiescent vs. Input Voltage

Fig. 7 - Quiescent vs. Temperature

Fig. 5 - Off Supply Current vs. Input Voltage

Fig. 8 - Off Supply Current vs. Temperature

Fig. 6 - Off Supply Current vs. Input Voltage

Fig. 9 - Off Supply Current vs. Temperature

TYPICAL CHARACTERISTICS (internally regulated, 25 °C, unless otherwise noted)

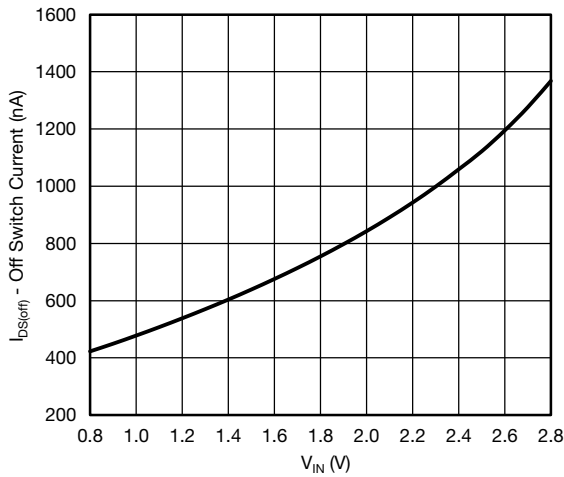

Fig. 10 - Off Switch Current vs. Input Voltage

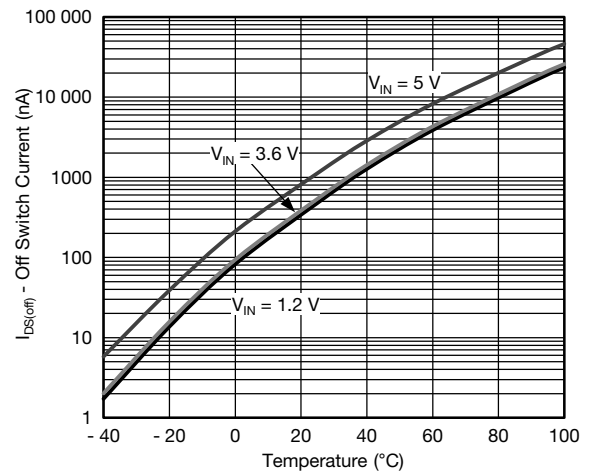

Fig. 13 - Off Switch Current vs. Temperature

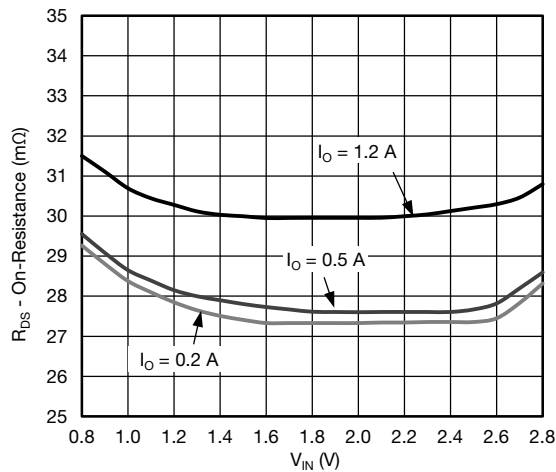

Fig. 11 - On Resistance vs. Input Voltage

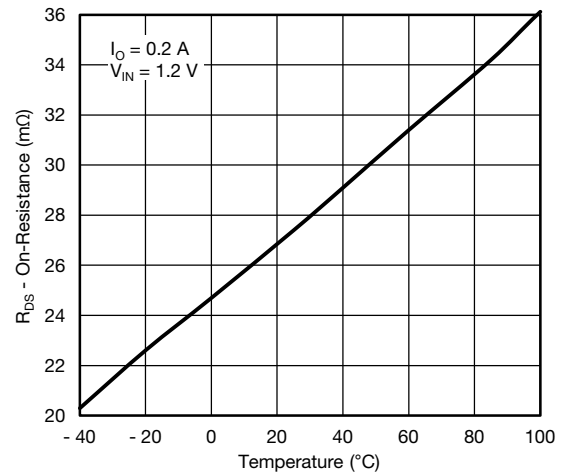

Fig. 14 - On Resistance vs. Temperature

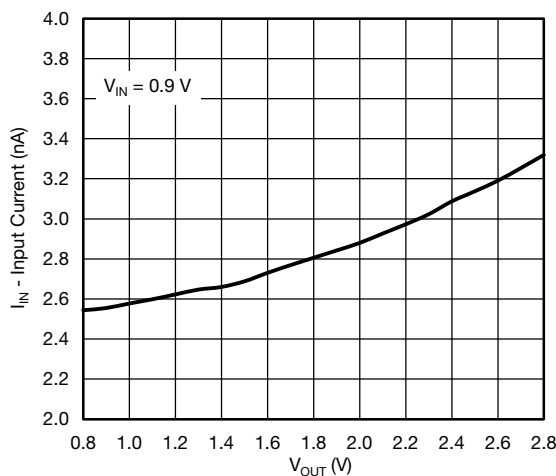

Fig. 12 - Reverse Blocking Current vs. Output Voltage

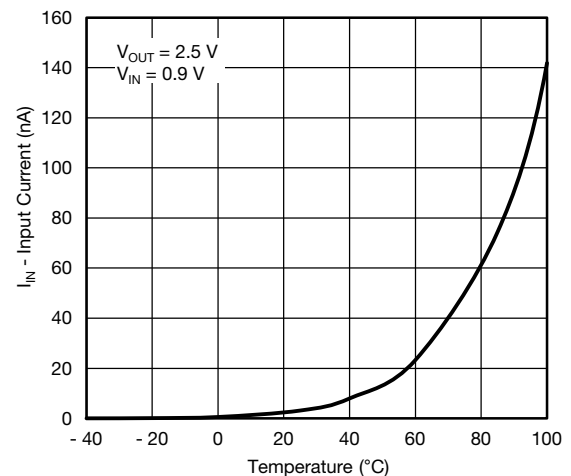
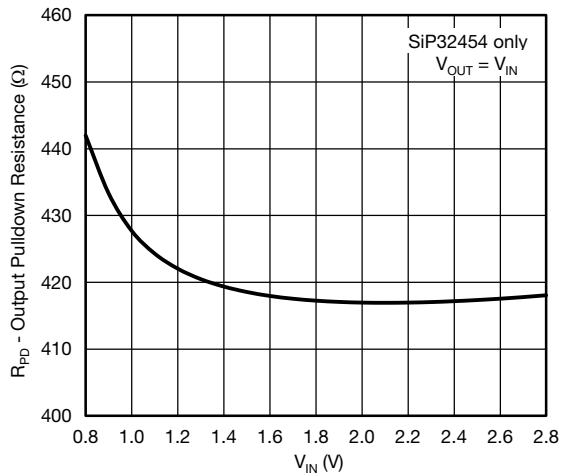
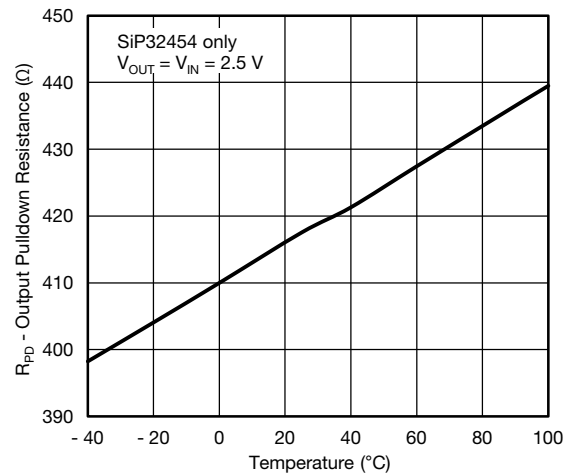
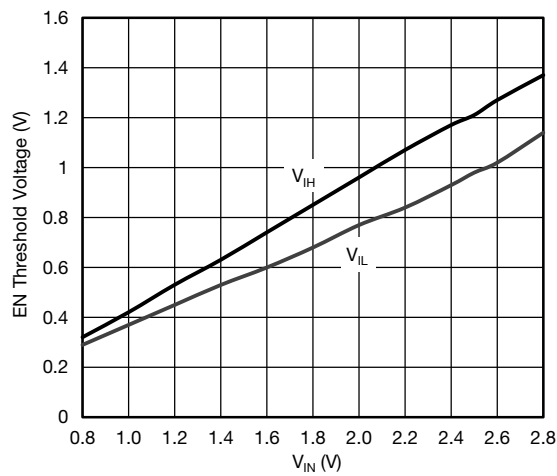
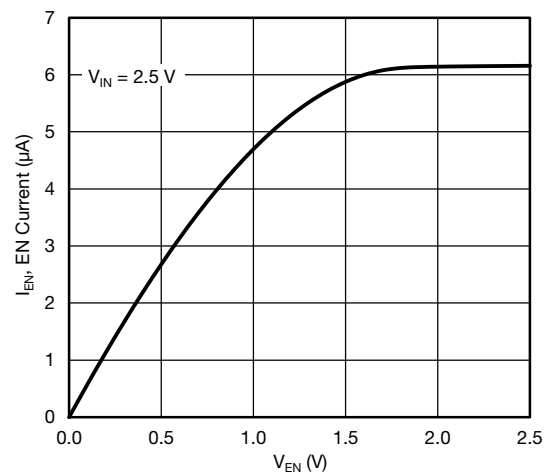
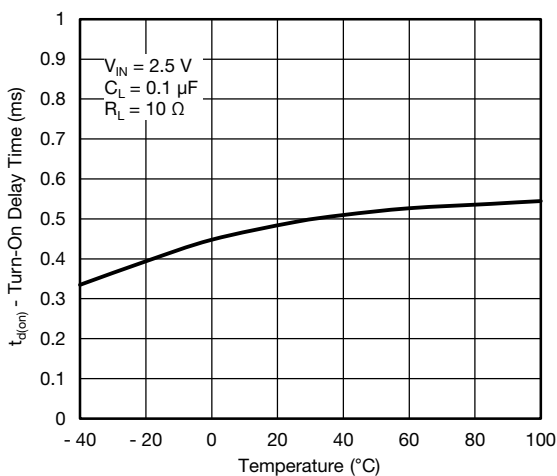
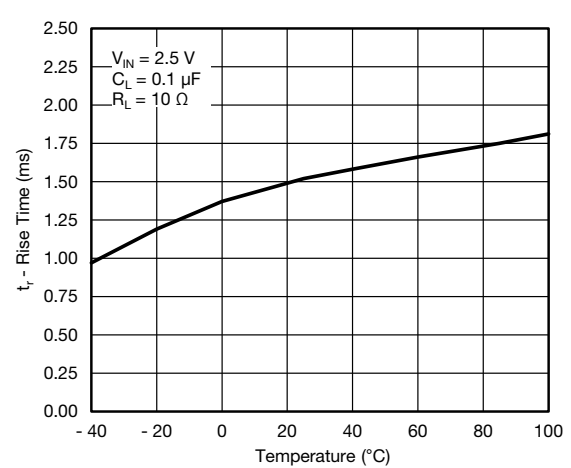

Fig. 15 - Reverse Blocking Current vs. Temperature

TYPICAL CHARACTERISTICS (internally regulated, 25 °C, unless otherwise noted)

Fig. 16 - Output Pull-Down Resistance vs. Input Voltage

Fig. 19 - Output Pull-Down Resistance vs. Temperature

Fig. 17 - EN Threshold Voltage vs. Input Voltage

Fig. 20 - EN Input Leakage vs. V_{EN}

Fig. 18 - Turn-On Delay Time vs. Temperature

Fig. 21 - Rise Time vs. Temperature

ELECTRICAL CHARACTERISTICS

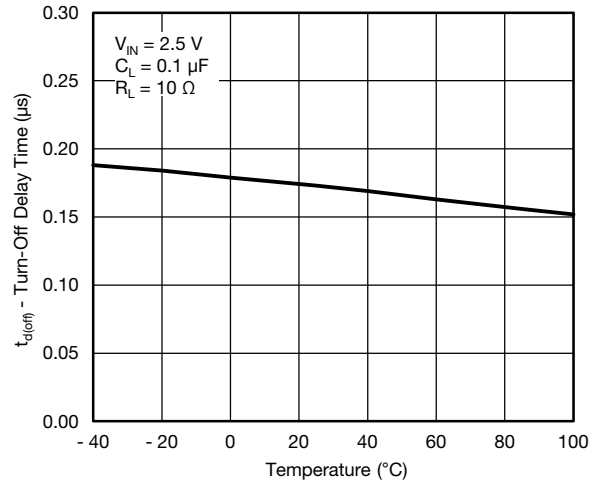

Fig. 22 - Turn-Off Delay Time vs. Temperature

TYPICAL WAVEFORMS

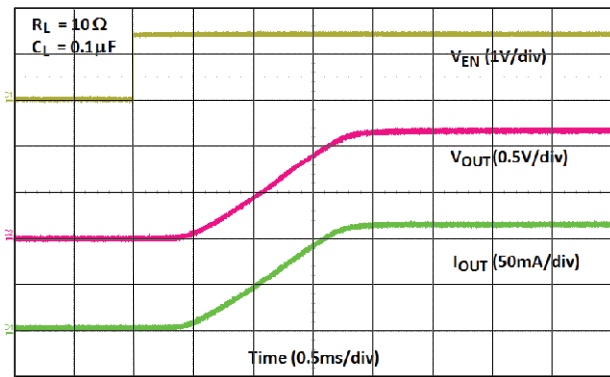

Fig. 23 - Turn-On Time (V_{IN} = 1.2 V)

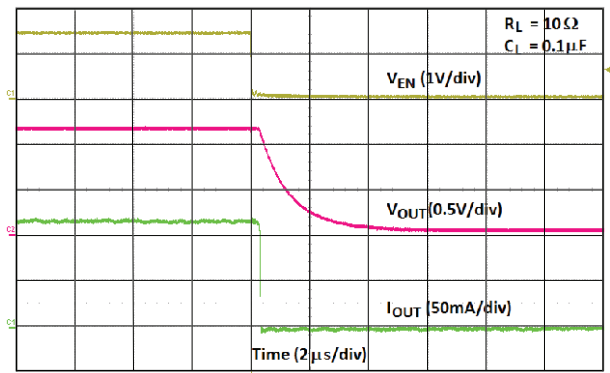

Fig. 25 - Turn-Off Time (V_{IN} = 1.2 V)

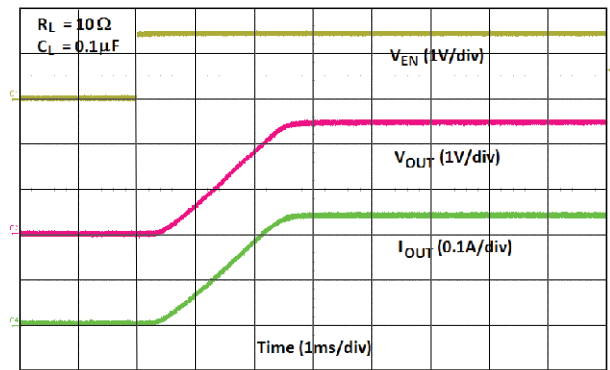

Fig. 24 - Turn-On Time (V_{IN} = 2.5 V)

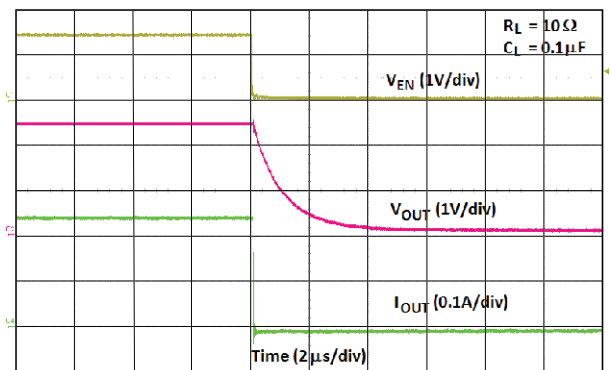

Fig. 26 - Turn-Off Time (V_{IN} = 2.5 V)



DETAILED DESCRIPTION

SiP32454 and SiP32455 are n-channel power MOSFET designed as high side load switch. Once enable the device charge pumps the gate of the power MOSFET to a constant gate to source voltage for fast turn on time. The mostly constant gate to source voltage keeps the on resistance low through out the input voltage range. SiP32454 and SiP32455 are designed with slow slew rate to minimize the inrush current during turn on. Because the body of the output n-channel is always connected to GND, it prevents the current from going back to the input in case the output voltage is higher than the output. The SiP32454 especially incorporates an active output pull-down resistor to discharge output capacitance when the device is off.

APPLICATION INFORMATION

Input Capacitor

While a bypass capacitor on the input is not required, a 4.7 μF or larger capacitor for C_{IN} is recommended in almost all applications. The bypass capacitor should be placed as physically close as possible to the input pin to be effective in minimizing transients on the input. Ceramic capacitors are recommended over tantalum because of their ability to withstand input current surges from low impedance sources such as batteries in portable devices.

Output Capacitor

A 0.1 μF capacitor across V_{OUT} and GND is recommended to insure proper slew operation. There is inrush current through the output MOSFET and the magnitude of the inrush current depends on the output capacitor, the bigger the C_{OUT} the higher the inrush current. There are no ESR or capacitor type requirement.

Enable

The EN pin is compatible with CMOS logic voltage levels. It requires at least 0.1 V or below to fully shut down the device and 1.5 V or above to fully turn on the device.

Protection Against Reverse Voltage Condition

Both the SiP32454 and SiP32455 can block the output current from going to the input in case where the output voltage is higher than the input voltage when the main switch is off.

Thermal Considerations

These devices are designed to maintain a constant output load current. Due to physical limitations of the layout and assembly of the device the maximum switch current is 1.2 A as stated in the Absolute Maximum Ratings table. However, another limiting characteristic for the safe operating load current is the thermal power dissipation of the package. To obtain the highest power dissipation (and a thermal resistance of 280 °C/W) the device should be connected to a heat sink on the printed circuit board.

The maximum power dissipation in any application is dependent on the maximum junction temperature, T_{J(max.)} = 125 °C, the junction-to-ambient thermal resistance, θ_{JA} = 280 °C/W, and the ambient temperature, T_A, which may be formulaically expressed as:

$$P \text{ (max.)} = \frac{T_{J(max.)} - T_A}{\theta_{JA}} = \frac{125 - T_A}{280}$$

It then follows that, assuming an ambient temperature of 70 °C, the maximum power dissipation will be limited to about 196 mW.

So long as the load current is below the 1.2 A limit, the maximum continuous switch current becomes a function two things: the package power dissipation and the R_{DS(on)} at the ambient temperature.

As an example let us calculate the worst case maximum load current at T_A = 70 °C. The worst case R_{DS(on)} at 25 °C is 35 mΩ. The R_{DS(on)} at 70 °C can be extrapolated from this data using the following formula:

$$R_{DS(on)} \text{ (at 70 °C)} = R_{DS(on)} \text{ (at 25 °C)} \times (1 + T_C \times \Delta T)$$

Where T_C is 4100 ppm/°C. Continuing with the calculation we have

$$R_{DS(on)} \text{ (at 70 °C)} = 35 \text{ m}\Omega \times (1 + 0.0041 \times (70 \text{ °C} - 25 \text{ °C})) = 42.2 \text{ m}\Omega$$

The maximum current limit is then determined by

$$I_{LOAD(max.)} < \sqrt{\frac{P \text{ (max.)}}{R_{DS(on)}}}$$

which in this case is 2.1 A. Under the stated input voltage condition, if the 2.1 A current limit is exceeded the internal die temperature will rise and eventually, possibly damage the device.

To avoid possible permanent damage to the device and keep a reasonable design margin, it is recommended to operate the device maximum up to 1.2 A only as listed in the Absolute Maximum Ratings table.



| PRODUCT SUMMARY | | |
|--|---|---|
| Part number | SiP32454 | SiP32455 |
| Description | 0.8 V to 2.5 V, 28 mΩ, 1.5 ms rise time, output discharge | 0.8 V to 2.5 V, 28 mΩ, 1.5 ms rise time |
| Configuration | Single | Single |
| Slew rate time (μs) | 1000 | 1000 |
| On delay time (μs) | 600 | 600 |
| Input voltage min. (V) | 0.8 | 0.8 |
| Input voltage max. (V) | 2.5 | 2.5 |
| On-resistance at input voltage min. (mΩ) | 30 | 30 |
| On-resistance at input voltage max. (mΩ) | 28 | 28 |
| Quiescent current at input voltage min. (μA) | 4 | 4 |
| Quiescent current at input voltage max. (μA) | 32 | 32 |
| Output discharge (yes / no) | Yes | No |
| Reverse blocking (yes / no) | Yes | Yes |
| Continuous current (A) | 1.2 | 1.2 |
| Package type | WCSP4 | WCSP4 |
| Package size (W, L, H) (mm) | 0.8 x 0.8 x 0.5 | 0.8 x 0.8 x 0.5 |
| Status code | 2 | 2 |
| Product type | Slew rate | Slew rate |
| Applications | Computers, consumer, industrial, healthcare, networking, portable | Computers, consumer, industrial, healthcare, networking, portable |

Vishay Siliconix maintains worldwide manufacturing capability. Products may be manufactured at one of several qualified locations. Reliability data for Silicon Technology and Package Reliability represent a composite of all qualified locations. For related documents such as package/tape drawings, part marking, and reliability data, see www.vishay.com/ppg?62531.

WCSP4: 4 Bumps

(2 x 2, 0.4 mm pitch, 208 μm bump height, 0.8 mm x 0.8 mm die size)

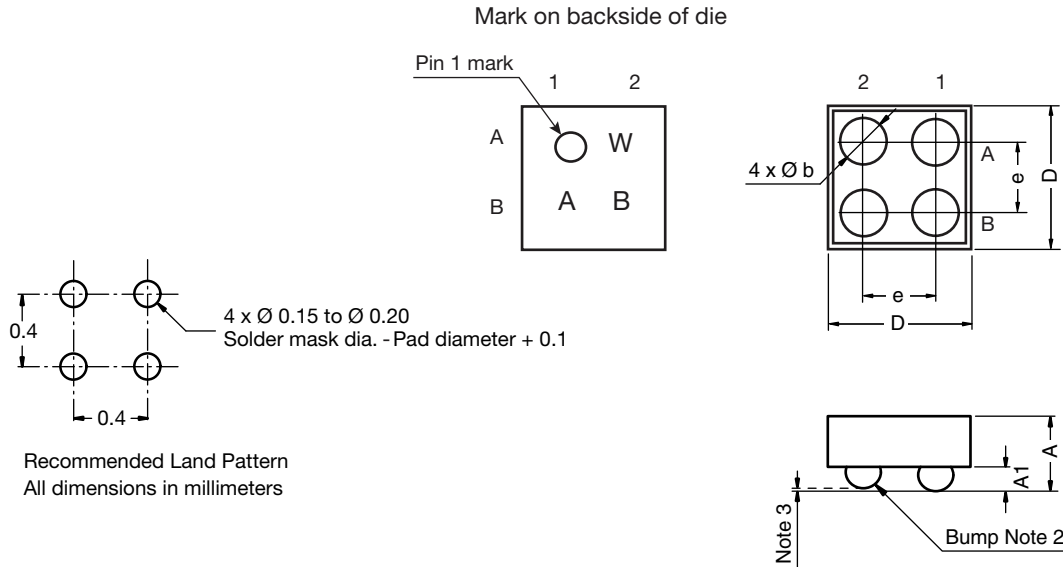

DWG-No: 6004

Notes

- (1) Laser mark on the backside surface of die
- (2) Bumps are SAC396
- (3) 0.05 max. coplanarity

| DIM. | MILLIMETERS ^a | | | INCHES | | |
|------|--------------------------|-------|-------|--------|--------|--------|
| | MIN. | NOM. | MAX. | MIN. | NOM. | MAX. |
| A | 0.515 | 0.530 | 0.545 | 0.0203 | 0.0209 | 0.0215 |
| A1 | 0.208 | | | 0.0082 | | |
| b | 0.250 | 0.260 | 0.270 | 0.0098 | 0.0102 | 0.0106 |
| e | 0.400 | | | 0.0157 | | |
| D | 0.720 | 0.760 | 0.800 | 0.0283 | 0.0299 | 0.0315 |

Note

- a. Use millimeters as the primary measurement



Disclaimer

ALL PRODUCT, PRODUCT SPECIFICATIONS AND DATA ARE SUBJECT TO CHANGE WITHOUT NOTICE TO IMPROVE RELIABILITY, FUNCTION OR DESIGN OR OTHERWISE.

Vishay Intertechnology, Inc., its affiliates, agents, and employees, and all persons acting on its or their behalf (collectively, "Vishay"), disclaim any and all liability for any errors, inaccuracies or incompleteness contained in any datasheet or in any other disclosure relating to any product.

Vishay makes no warranty, representation or guarantee regarding the suitability of the products for any particular purpose or the continuing production of any product. To the maximum extent permitted by applicable law, Vishay disclaims (i) any and all liability arising out of the application or use of any product, (ii) any and all liability, including without limitation special, consequential or incidental damages, and (iii) any and all implied warranties, including warranties of fitness for particular purpose, non-infringement and merchantability.

Statements regarding the suitability of products for certain types of applications are based on Vishay's knowledge of typical requirements that are often placed on Vishay products in generic applications. Such statements are not binding statements about the suitability of products for a particular application. It is the customer's responsibility to validate that a particular product with the properties described in the product specification is suitable for use in a particular application. Parameters provided in datasheets and / or specifications may vary in different applications and performance may vary over time. All operating parameters, including typical parameters, must be validated for each customer application by the customer's technical experts. Product specifications do not expand or otherwise modify Vishay's terms and conditions of purchase, including but not limited to the warranty expressed therein.

Hyperlinks included in this datasheet may direct users to third-party websites. These links are provided as a convenience and for informational purposes only. Inclusion of these hyperlinks does not constitute an endorsement or an approval by Vishay of any of the products, services or opinions of the corporation, organization or individual associated with the third-party website. Vishay disclaims any and all liability and bears no responsibility for the accuracy, legality or content of the third-party website or for that of subsequent links.

Except as expressly indicated in writing, Vishay products are not designed for use in medical, life-saving, or life-sustaining applications or for any other application in which the failure of the Vishay product could result in personal injury or death. Customers using or selling Vishay products not expressly indicated for use in such applications do so at their own risk. Please contact authorized Vishay personnel to obtain written terms and conditions regarding products designed for such applications.

No license, express or implied, by estoppel or otherwise, to any intellectual property rights is granted by this document or by any conduct of Vishay. Product names and markings noted herein may be trademarks of their respective owners.