

# FAN7527

## Power Factor Correction Controller

### Features

- Internal Startup Timer
- Internal R/C Filter Eliminates the Need for an External R/C Filter
- Very Precise Adjustable Output Over Voltage Protection
- Zero Current Detector
- One Quadrant Multiplier
- Trimmed 1.5% Internal Band gap Reference
- Under Voltage Lock Out with 3V of Hysteresis
- Totem Pole Output with High State Clamp
- Low Startup and Operating Current
- 8-Pin DIP or 8-Pin SOP

### Applications

- Electronic Ballast
- SMPS

### Description

The FAN7527 provides simple and high performance active power factor correction. FAN7527 is optimized for electronic ballast and low power, high density power supplies which require minimum board area reduced component count and low power dissipation. Internal R/C filter eliminates the need for an external R/C filter. Internally clamping the error amplifier and multiplier outputs, improves turn on overshoot characteristics and current limiting. Special circuitry has also been added to prevent no load runaway conditions. Independent of supply voltage, the output drive clamping circuit limits overshoot of the power MOSFET gate drive. This greatly enhances the system reliability.

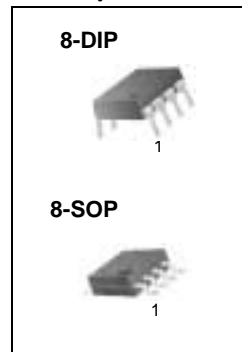

# Internal Block Diagram

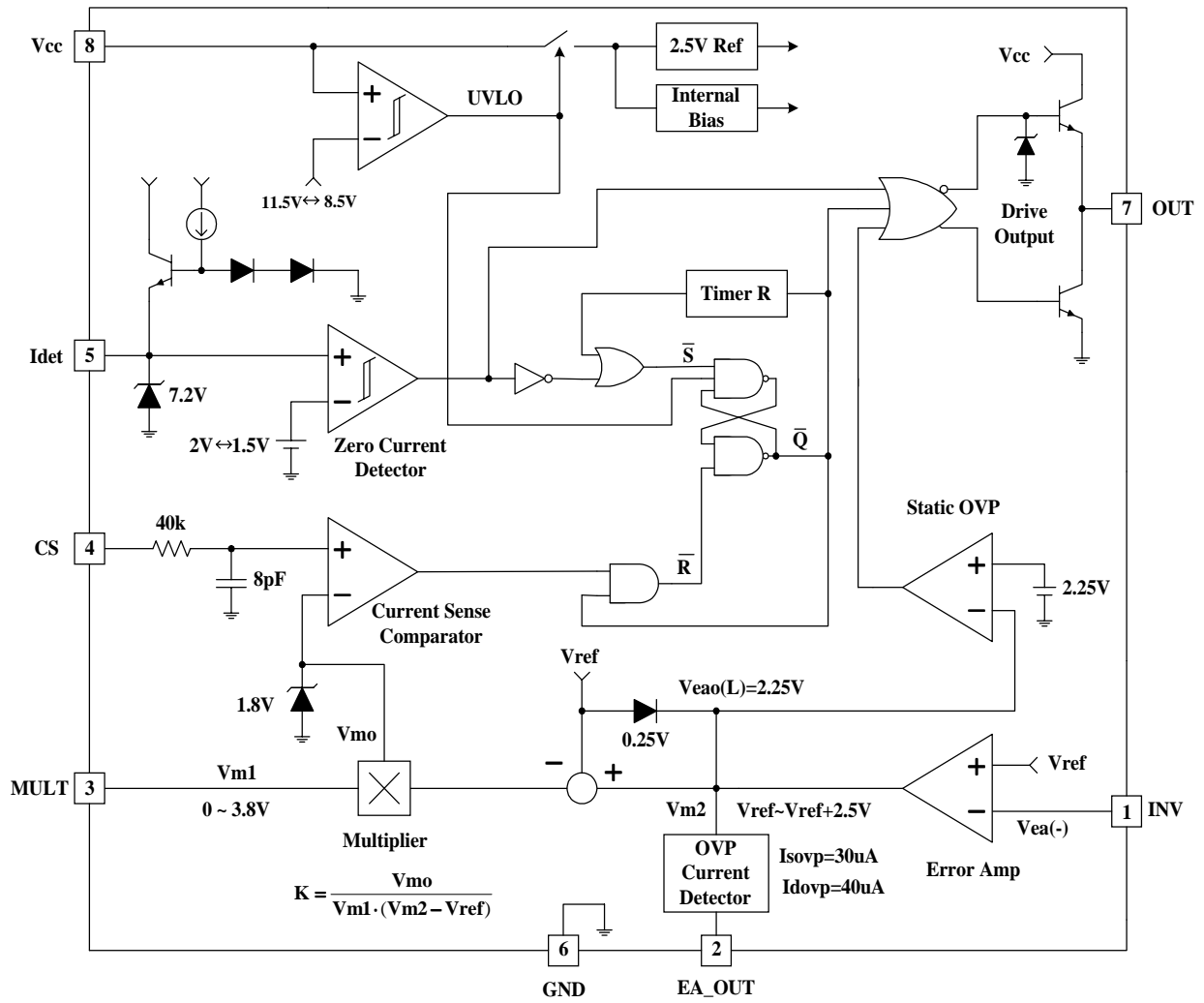

## Pin Description

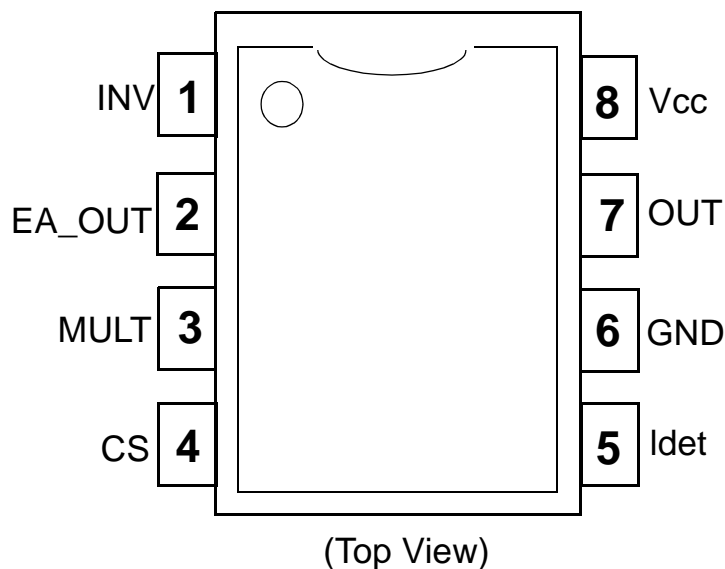

Pin Number	Pin Name	Pin Function Description
1	INV	Inverting input of the error amplifier. The output of the boost converter should be resistively divided to 2.5V and connected to this pin.
2	EA_OUT	The output of the error amplifier. A feedback compensation network is placed between this pin and the INV pin.
3	MULT	Input to the multiplier stage. The full-wave rectified AC is divided to less than 2V and is connected to this pin.
4	CS	Input to the PWM comparator. Current is sensed in the boost stage MOSFET by a resistor in the source lead. An internal leading edge blanking circuitry has been included to reject any high frequency noise present on the current waveform.
5	Idet	The zero current detector senses the inductor current by monitoring when the boost inductor auxiliary winding voltage falls below 1.8V.
6	GND	The ground potential of all the pins.
7	OUT	Gate driver output . A push pull output stage is able to drive the Power MOSFET with peak current of 400mA.
8	Vcc	Supply voltage of driver and control circuits.

## Absolute Maximum Ratings (Ta=25°C)

Characteristics	Symbol	Value	Unit
Supply Voltage	V <sub>CC</sub>	30	V
Peak Drive Output Current	I <sub>OH</sub> , I <sub>OL</sub>	±500	mA
Driver Output Clamping Diodes V <sub>o</sub> > V <sub>CC</sub> or V <sub>o</sub> < -0.3V	I <sub>clamp</sub>	±10	mA
Detector Clamping Diodes	I <sub>det</sub>	±10	mA
Error Amp, Multiplier And Comparator Input Voltages	V <sub>in</sub>	-0.3 to 6	V
Operating Junction Temperature	T <sub>j</sub>	150	°C
Operating Temperature Range	T <sub>opr</sub>	-25 to 125	°C
Storage Temperature Range	T <sub>stg</sub>	-65 to 150	°C
Power Dissipation	P <sub>d</sub>	0.8	W

## Temperature Characteristics (-25°C ≤ Ta ≤ 125°C)

Characteristics	Symbol	Min.	Typ.	Max.	Unit
Temperature Stability for Reference Voltage (V <sub>ref</sub> )	ΔV <sub>ref</sub>	-	20	-	mV
Temperature Stability for Multiplier Gain (K)	ΔK/ΔT	-	0.2	-	%/°C

## Electrical Characteristics

V<sub>CC</sub>= 14V, -25°C ≤ T<sub>a</sub> ≤ 125°C, unless otherwise stated.

Characteristics	Symbol	Test Condition	Min.	Typ.	Max.	Unit
<b>&lt; UNDER VOLTAGE LOCK OUT SECTION &gt;</b>						
Start Threshold Voltage	V <sub>th(st)</sub>	V <sub>CC</sub> Increasing	10.5	11.5	12.5	V
UVLO Hysteresis	HY(st)	-	2	3	4	V
<b>&lt; SUPPLY CURRENT SECTION &gt;</b>						
Start-up Supply Current	I <sub>st</sub>	V <sub>CC</sub> = V <sub>th(st)</sub> - 0.2V	20	60	100	uA
Operating Supply Current	I <sub>CC</sub>	Output not switching	-	3	6	mA
Operating Current at OVP	I <sub>CC(OVP)</sub>	V <sub>inv</sub> = 3V	-	1.7	4	mA
Dynamic Operating Supply Current	I <sub>dCC</sub>	50kHz, C <sub>I</sub> = 1nF	-	4	8	mA
<b>&lt; ERROR AMPLIFIER SECTION &gt;</b>						
Voltage Feedback Input Threshold	V <sub>ref</sub>	I <sub>ref</sub> = 0mA, T <sub>a</sub> = 25°C	2.465	2.5	2.535	V
		-25 ≤ T <sub>a</sub> ≤ 125°C	2.44	2.5	2.56	V
Line Regulation	ΔV <sub>ref1</sub>	14V ≤ V <sub>CC</sub> ≤ 25V	-	0.1	10	mV
Temperature Stability Of V <sub>ref</sub> (Note1)	ΔV <sub>ref3</sub>	-25 ≤ T <sub>a</sub> ≤ 125°C	-	20	-	mV
Input Bias Current	I <sub>b(ea)</sub>	-	-0.5	-	0.5	uA
Output Source Current	I <sub>source</sub>	V <sub>m2</sub> = 4V	-2	-4	-	mA
Output Sink Current	I <sub>sink</sub>	V <sub>m2</sub> = 4V	2	4	-	mA
Output Upper Clamp Voltage (Note2)	V <sub>ea0(H)</sub>	I <sub>source</sub> = 0.1mA	-	6	-	V
Output Lower Clamp Voltage (Note3)	V <sub>ea0(L)</sub>	I <sub>sink</sub> = 0.1mA	-	2.25	-	V
Large Signal Open Loop Gain (Note4)	G <sub>v</sub>	-	60	80	-	dB
Power Supply Rejection Ratio (Note5)	PSRR	14V ≤ V <sub>CC</sub> ≤ 25V	60	80	-	dB
Unity Gain Bandwidth (Note6)	GBW	-	-	1	-	MHz
Slew Rate (Note7)	SR	-	-	0.6	-	V/us
<b>&lt; MULTIPLIER SECTION &gt;</b>						
Input Bias Current (Pin3)	I <sub>b(m)</sub>	-	-0.5	-	0.5	uA
M1 Input Voltage Range (Pin3)	ΔV <sub>m1</sub>	-	0	-	3.8	V
M2 Input Voltage Range (Pin2)	ΔV <sub>m2</sub>	-	V <sub>ref</sub>	-	V <sub>ref</sub> +2.5	V
Multiplier Gain (Note8)	K	V <sub>m1</sub> = 1V, V <sub>m2</sub> = 3.5V	0.36	0.44	0.52	1/V
Maximum Multiplier Output Voltage	V <sub>omax(m)</sub>	V <sub>inv</sub> = 0V, V <sub>m1</sub> = 4V	1.65	1.8	1.95	V
Temperature Stability Of K (Note9)	ΔK/ΔT	-25 ≤ T <sub>a</sub> ≤ 125°C	-	-0.2	-	%/°C

**Electrical Characteristics**(Continued)

(VCC= 14V, -25°C ≤ Ta ≤ 125°C, unless otherwise stated.)

Characteristics	Symbol	Test Condition	Min.	Typ.	Max.	Unit
<b>&lt; CURRENT SENSE SECTION &gt;</b>						
Input Offset Voltage (Note8)	V <sub>io(cs)</sub>	V <sub>m1</sub> =0V , V <sub>m2</sub> = 2.2V	-10	3	10	mV
Input Bias Current	I <sub>b(cs)</sub>	0V ≤ V <sub>cs</sub> ≤ 1.7V	-1	-0.1	1	uA
Current Sense Delay To Output (Note11)	t <sub>d(cs)</sub>	-	-	200	500	ns
<b>&lt; DETECT SECTION &gt;</b>						
Input Voltage Threshold	V <sub>th(det)</sub>	V <sub>det</sub> Increasing	1.7	2	2.3	V
Detect Hysteresis	HY <sub>(det)</sub>	-	0.2	0.5	0.8	V
Input Low Clamp Voltage	V <sub>clamp(l)</sub>	I <sub>det</sub> = -100uA	0.45	0.75	1	V
Input High Clamp Voltage	V <sub>clamp(h)</sub>	I <sub>det</sub> = 3mA	6.5	7.2	7.9	V
Input Bias Current	I <sub>b(det)</sub>	1V ≤ V <sub>det</sub> ≤ 5V	-1	-0.1	1	uA
Input High/Low Clamp Diode Current (Note12)	I <sub>clamp(d)</sub>	-	-	-	±3	mA
<b>&lt; OUTPUT SECTION &gt;</b>						
Output Voltage High	V <sub>oh</sub>	I <sub>o</sub> = -10mA	10.5	11	-	V
Output Voltage Low	V <sub>ol</sub>	I <sub>o</sub> = 10mA	-	0.8	1	V
Rising Time (Note13)	t <sub>r</sub>	CI = 1nF	-	130	200	ns
Falling Time (Note14)	t <sub>f</sub>	CI = 1nF	-	50	120	ns
Maximum Output Voltage	V <sub>omax(o)</sub>	V <sub>cc</sub> = 20V, I <sub>o</sub> = 100uA	12	14	16	V
Output Voltage With UVLO Activated	V <sub>omin(o)</sub>	V <sub>cc</sub> = 5V , I <sub>o</sub> = 100uA	-	-	1	V
<b>&lt; RESTART TIMER SECTION &gt;</b>						
Restart Time Delay	t <sub>d(rst)</sub>	V <sub>m1</sub> = 1V, V <sub>m2</sub> = 3.5V	-	500	-	us
<b>&lt; OVER VOLTAGE PROTECTION SECTION &gt;</b>						
Soft OVP Detecting Current	I <sub>sovp</sub>	-	25	30	35	uA
Dynamic OVP Detecting Current	I <sub>dovp</sub>	-	35	40	45	uA
Static OVP Threshold Voltage	V <sub>ovp</sub>	V <sub>inv</sub> = 2.7V	2.1	2.25	2.4	V

**Note** : 1 ~ 14 These parameters, although guaranteed, are not 100% tested in production.

$$\text{Multiplier Gain: } K = \frac{\text{Pin4\_Threshold}}{V_{m1} \times (V_{m2} - V_{ref})} \dots\dots (V_{m1} = V_{pin3}, V_{m2} = V_{pin2})$$

# Typical Performance Characteristics

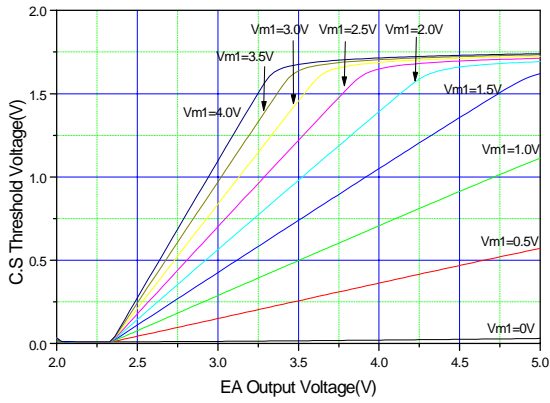

**Figure 1. Error Amplifier Output Voltage vs Current Sensing Threshold**

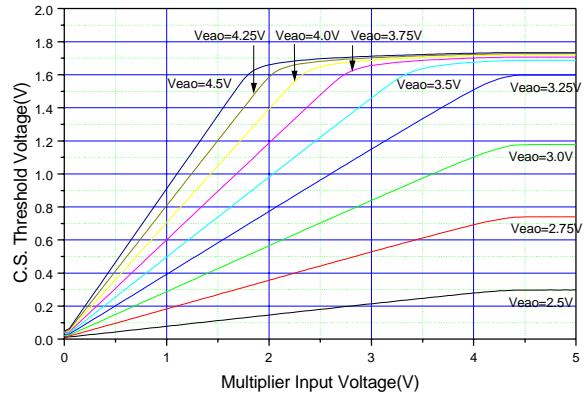

**Figure 2. Multiplier Input Voltage vs Current Sensing Threshold**

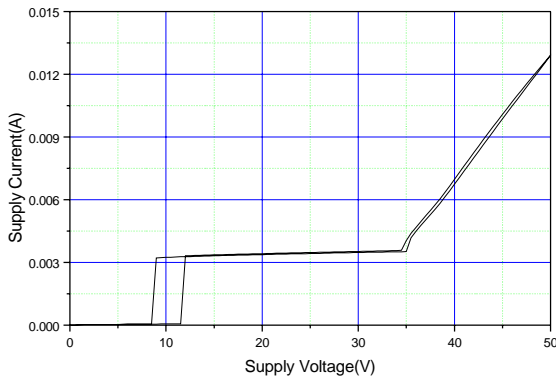

**Figure 3. Supply Current vs Supply Voltage**

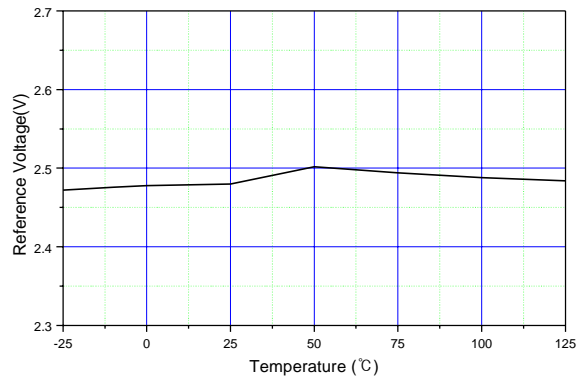

**Figure 4. Reference Voltage vs Temperature**

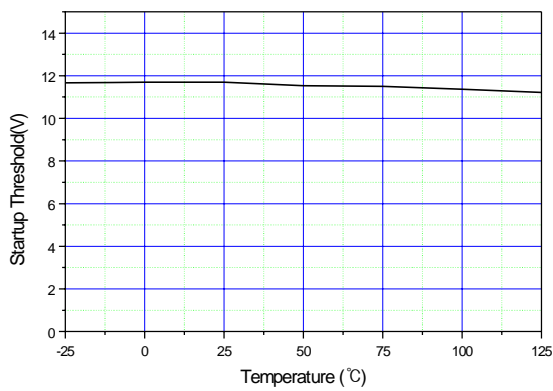

**Figure 5. Start-Up Threshold vs Temperature**

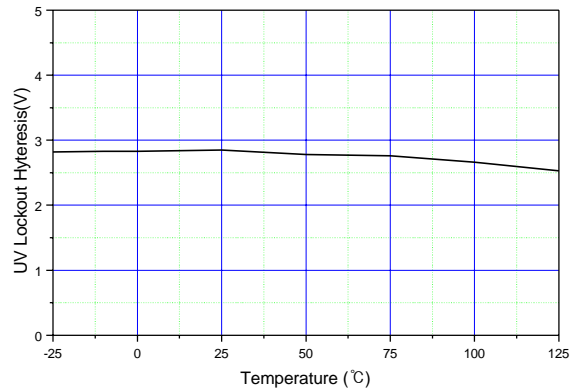

**Figure 6. UV Lockout Hysteresis vs Temperature**

Typical Performance Characteristics (Continued)

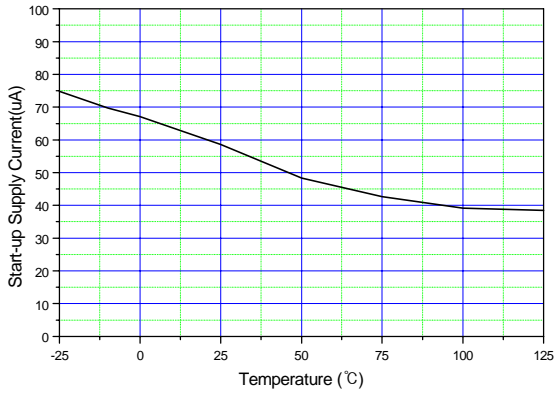

Figure 7. Start-Up Supply Current vs Temperature

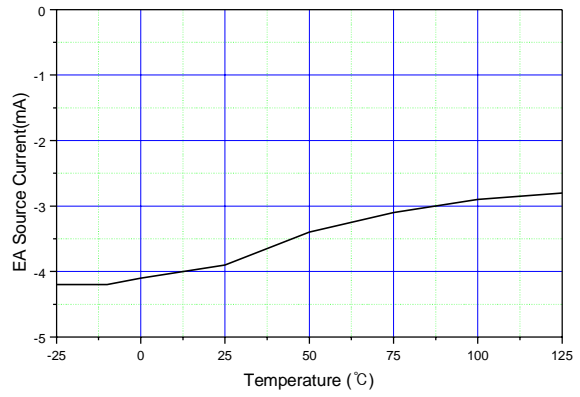

Figure 8. Error Amplifier Source Current vs Temperature

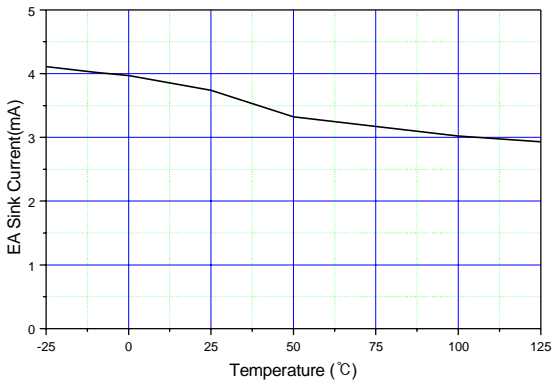

Figure 9. Error Amplifier Sink Current vs Temperature

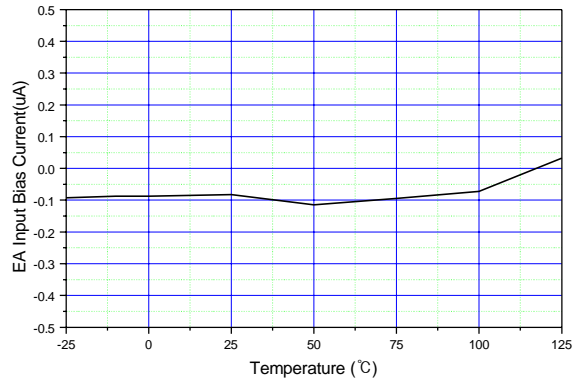

Figure 10. Error Amplifier Input Bias Current vs Temperature

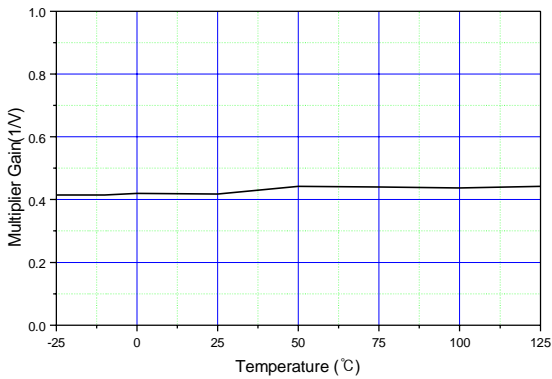

Figure 11. Multiplier Gain vs Temperature

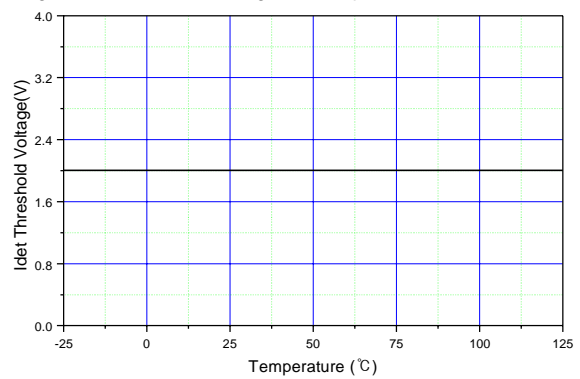
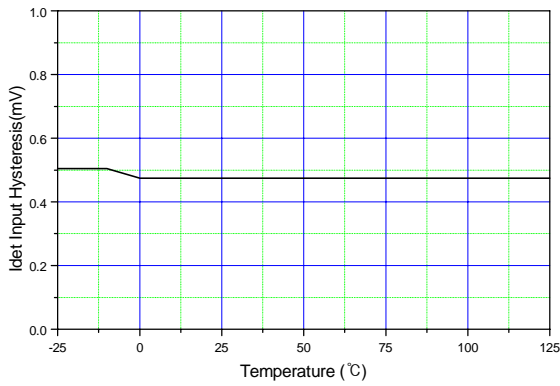

Figure 12. Idet Threshold Voltage vs Temperature



**Typical Performance Characteristics** (Continued)



**Figure 13. Idet Input Hysteresis vs Temperature**

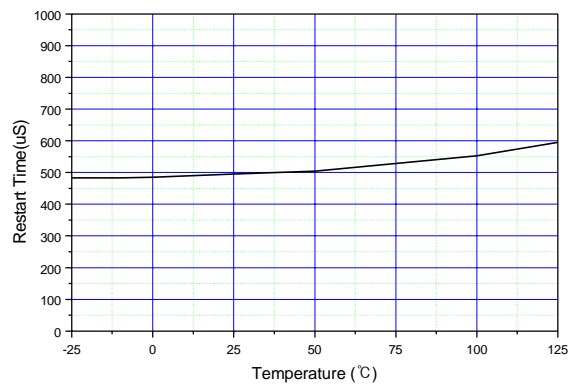

**Figure 14. Restart Time vs Temperature**

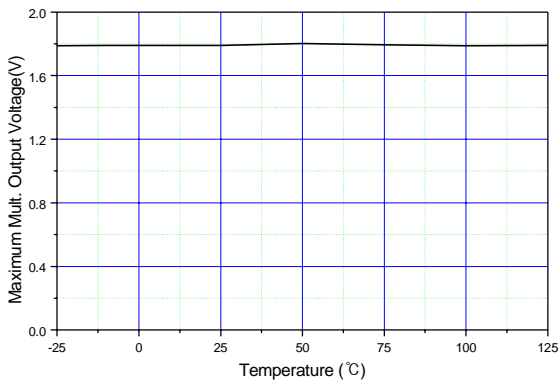

**Figure 15. Max.Mult.Output Voltage vs Temperature**

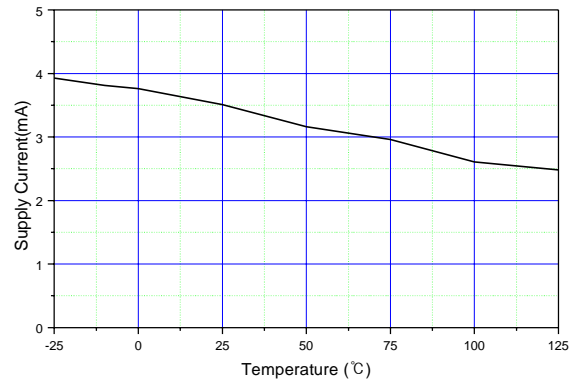

**Figure 16. Supply Current vs Temperature**

# Mechanical Dimensions

## Package

Dimensions in millimeters

### 8-DIP

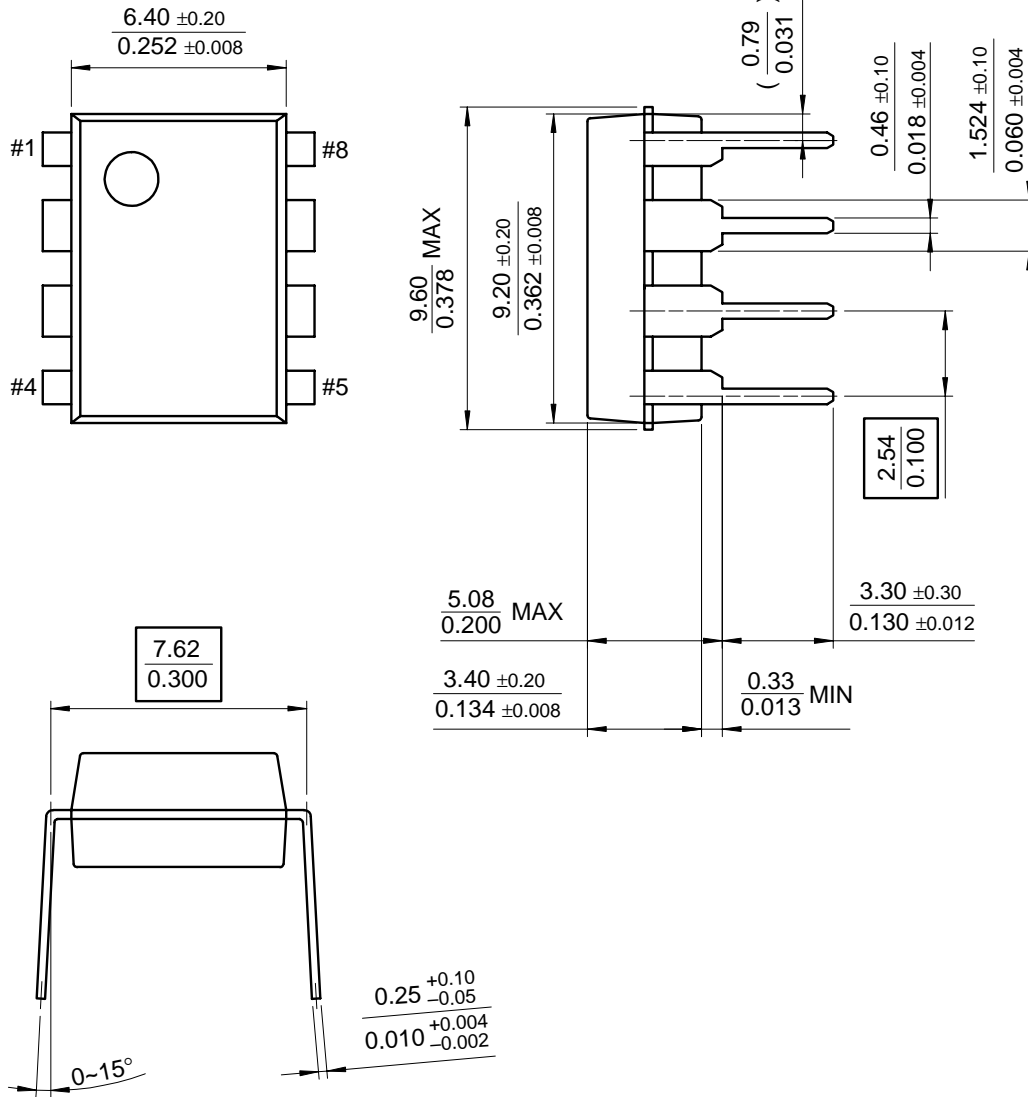

Mechanical Dimensions (Continued)

Package

Dimensions in millimeters

8-SOP

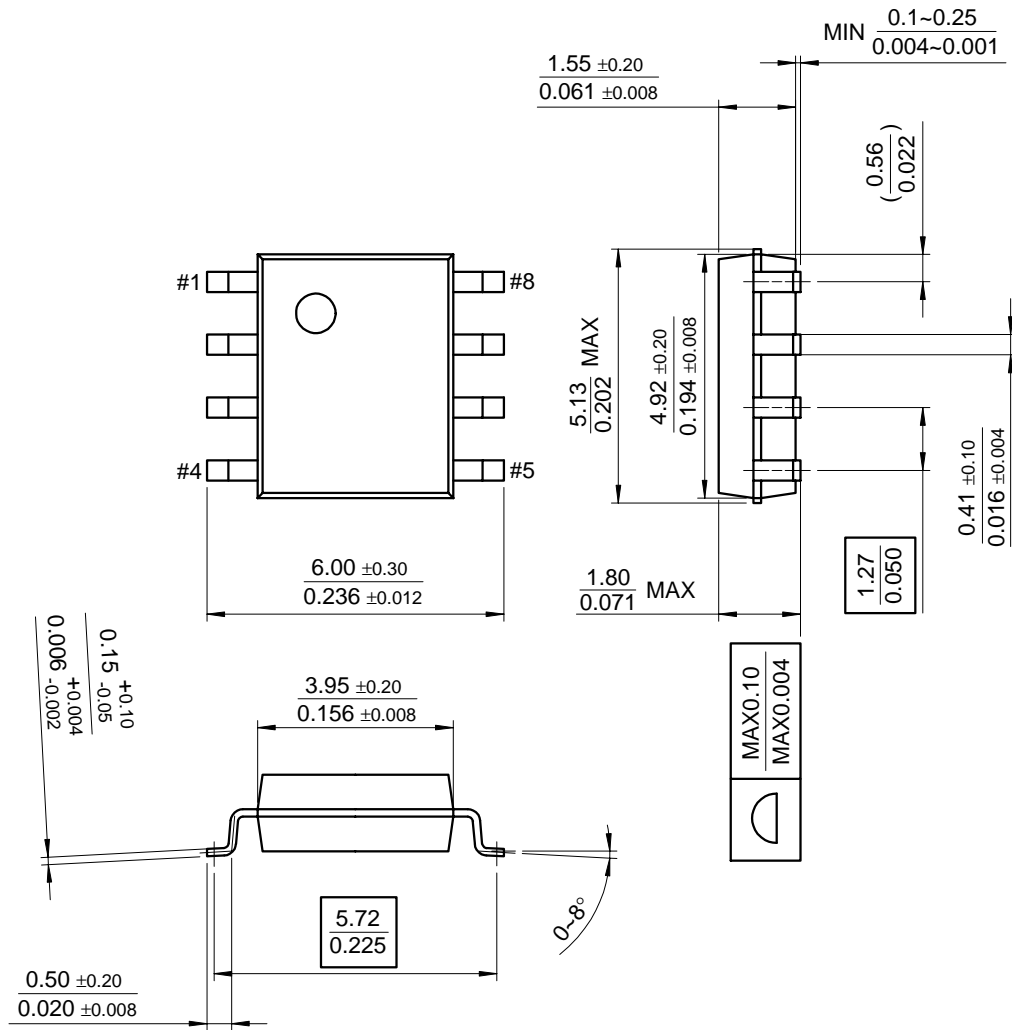

## Ordering Information

Product Number	Package	Operating Temperature
FAN7527	8-DIP	-25 ~ +125°C
FAN7527D	8-SOP	

### DISCLAIMER

FAIRCHILD SEMICONDUCTOR RESERVES THE RIGHT TO MAKE CHANGES WITHOUT FURTHER NOTICE TO ANY PRODUCTS HEREIN TO IMPROVE RELIABILITY, FUNCTION OR DESIGN. FAIRCHILD DOES NOT ASSUME ANY LIABILITY ARISING OUT OF THE APPLICATION OR USE OF ANY PRODUCT OR CIRCUIT DESCRIBED HEREIN; NEITHER DOES IT CONVEY ANY LICENSE UNDER ITS PATENT RIGHTS, NOR THE RIGHTS OF OTHERS.

### LIFE SUPPORT POLICY

FAIRCHILD'S PRODUCTS ARE NOT AUTHORIZED FOR USE AS CRITICAL COMPONENTS IN LIFE SUPPORT DEVICES OR SYSTEMS WITHOUT THE EXPRESS WRITTEN APPROVAL OF THE PRESIDENT OF FAIRCHILD SEMICONDUCTOR CORPORATION. As used herein:

1. Life support devices or systems are devices or systems which, (a) are intended for surgical implant into the body, or (b) support or sustain life, and (c) whose failure to perform when properly used in accordance with instructions for use provided in the labeling, can be reasonably expected to result in a significant injury of the user.
2. A critical component in any component of a life support device or system whose failure to perform can be reasonably expected to cause the failure of the life support device or system, or to affect its safety or effectiveness.