

R2A20133BSP

R03DS0050EJ0300

Rev.3.00

Nov 27, 2012

Critical Conduction Mode PFC Control IC

Description

The R2A20133B controls a boost converter to provide an active power factor correction.

The R2A20133B adopts critical conduction mode for power factor correction and realizes high efficiency and a low switching noise by zero current switching.

Because the zero current is detected by using the GND current, the ZCD Auxiliary winding is unnecessary.

The feedback loop open detection, two mode overvoltage protection, overcurrent protection are built in the R2A20133B, and can constitute a power supply system of high reliability with few external parts.

Features

- Absolute Maximum Ratings
 - Supply voltage V_{cc} : 24 V
 - Operating junction temperature T_{jopr} : -40 to +150°C
- Electrical characteristics
 - UVLO operation start voltage V_H : 12 V \pm 0.8 V
 - UVLO operation shutdown voltage V_L : 9.2 V \pm 0.7 V
 - UVLO hysteresis voltage H_{ysvvl} : 2.8 V \pm 0.7 V
- Functions
 - Boost converter control with critical conduction mode
 - Two mode overvoltage protection and OVP2
 - Mode 1: Dynamic OVP corresponding to a voltage rise by load change
 - Mode 2: Static OVP corresponding to overvoltage in stable.
 - OVP2: OVP2 sense the PFC output voltage by independent pin.
 - Feedback loop open detection
 - Overcurrent protection
 - Dynamic UVP corresponding to a voltage fall by load change
 - Off Time Control function (Frequency Limiter)
 - Package lineup: Pb-free SOP-8 (JEDEC)

Ordering Information

Part No.	Package Name	Package Code	Package Abbreviation	Taping Abbreviation (Quantity)
R2A20133BSP#W5	—	PRSP0008DJ-A	SP	W (2,500 pcs/reel)

Pin Arrangement

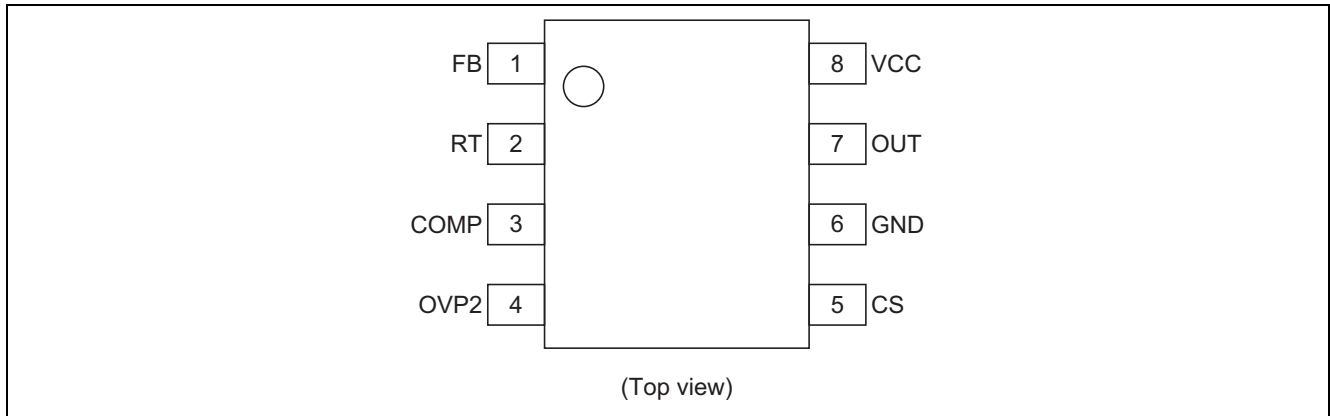

Pin Function

Pin No.	Pin Name	Function
1	FB	Error amplifier input terminal
2	RT	A resistor connection terminal for RAMP current setting
3	COMP	Error amplifier output terminal
4	OVP2	Over voltage detection terminal
5	CS	Zero current detection and overcurrent detection input terminal
6	GND	Ground
7	OUT	Power MOSFET drive terminal
8	VCC	Supply voltage terminal

Block Diagram

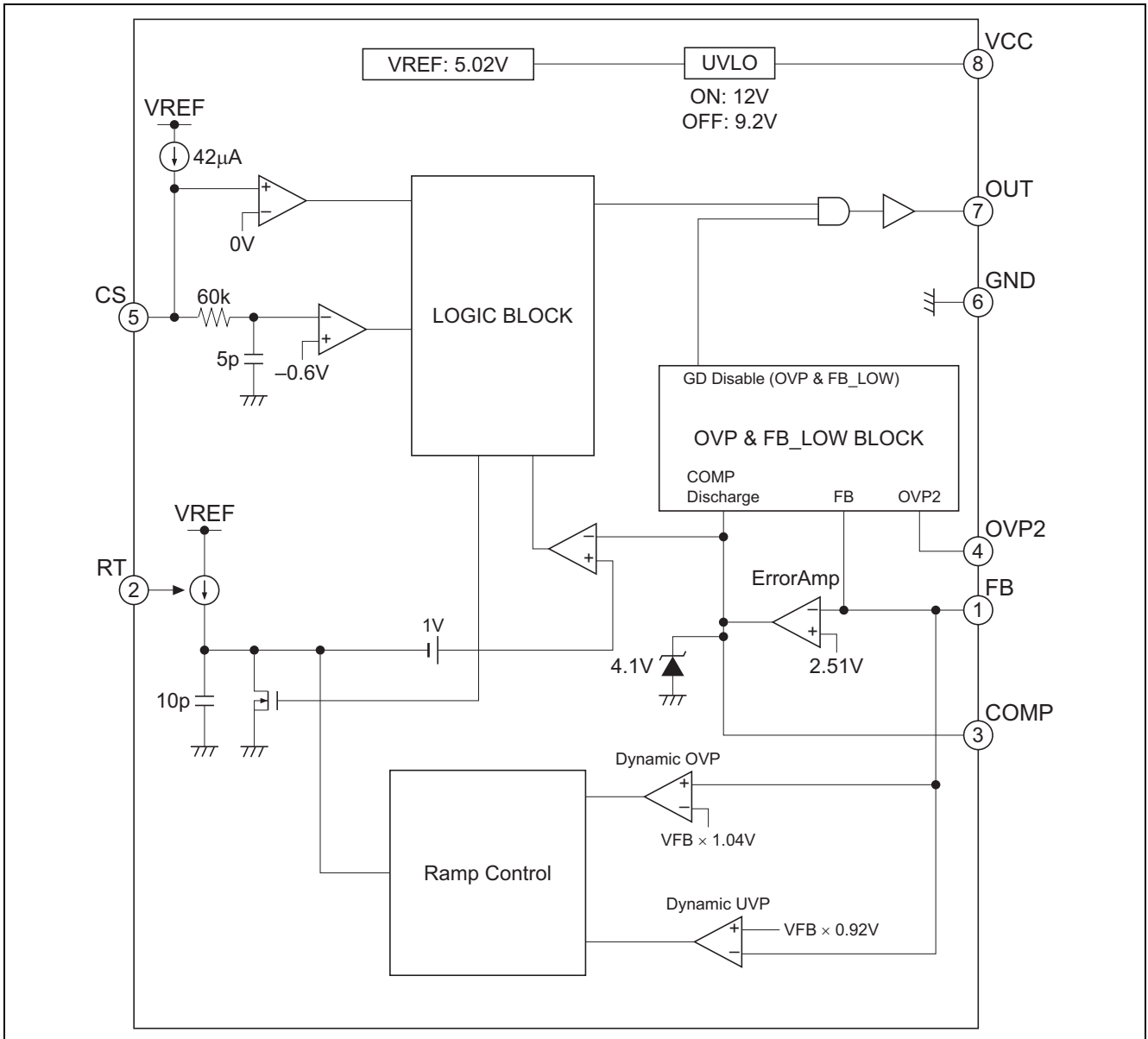

Absolute Maximum Ratings

(Ta = 25°C)

Item	Symbol	Ratings	Unit	Note
Supply Voltage	VCC	-0.3 to +24	V	
OUT terminal peak current	Ipk-snk-out	0.9	A	3
	Ipk-src-out	-0.50		
OUT terminal DC current	Idc-snk-out	100	mA	
	Idc-src-out	-50		
COMP terminal current	Icomp	+1 -1	mA	
RT terminal current	Irt	-60 to -2	μA	
Terminal voltage	Vt-group1	-0.3 to VCC	V	4
	Vt-group2	-0.3 to 5.3		5
CS terminal voltage	Vcs	-5 to +0.3	V	
Power dissipation	Pt	0.68	W	6
Operating junction temperature	Tj-opr	-40 to +150	°C	
Storage temperature	Tstg	-55 to +150	°C	

- Notes:
1. Rated voltages are with reference to the GND terminal.
 2. For rated currents, inflow to the IC is indicated by (+), and outflow by (-).
 3. Shows the transient current when driving a capacitive load.
 4. This is the rated voltage for the following pins:
OUT
 5. This is the rated voltage for the following pins:
FB, COMP, OVP2, RT
 6. In case of R2A20133ASP (SOP): $\theta_{ja} = 120^{\circ}\text{C/W}$
This value is a thing mounting on $40 \times 40 \times 1.6$ [mm], a glass epoxy board of wiring density 10%.

Electrical Characteristics

(Ta = 25°C, VCC = 12 V, CS = 0.1 V, FB = COMP, OVP2 = 0 V, RRT = 200 kΩ)

Item		Symbol	Min	Typ	Max	Unit	Test Conditions
Supply	UVLO turn-on threshold	Vuvlh	11.2	12	12.8	V	
	UVLO turn-off threshold	Vuvll	8.5	9.2	9.9	V	
	UVLO hysteresis	Hysuvl	2.1	2.8	3.5	V	
	Standby current	Istby	—	130	250	μA	VCC = Vuvlh – 0.2 V
	Operating current	Icc	—	1.8	2.6	mA	
Error amplifier	Feedback voltage	Vfb	2.472	2.510	2.548	V	FB-COMP short
	Temperature stability	dVfb	—	±80	—	ppm/°C	Ta = –40 to +125°C * ¹
	Input bias current	Ifb	–0.40	–0.15	–0.05	μA	Measured pin: FB
	Open loop gain	Av	—	65	—	dB	* ¹
	Upper clamp voltage	Vclamp-comp	3.65	4.10	4.3	V	FB = 2.0 V COMP: Open
	Low voltage	Vl-comp	—	0.1	0.3	V	FB = 3.0 V COMP: Open
	Source current1	Isrc-comp1	–13.5	–10	–6	μA	FB = 1.7 V COMP = 2.5 V
	Source current2	Isrc-comp2	Isrc-comp1 ×3.3	Isrc-comp1 ×3.0	Isrc-comp1 ×2.7	μA	FB = 1.5 V COMP = 2.5 V
	Sink current	Isnk-comp	6	10	13.5	μA	FB = 3.5 V COMP = 2.5 V
Transconductance	gm	25	46	75	μS	FB = 2.45V ↔ 2.55 V COMP = 2.5 V	
RT	RAMP offset voltage	Voff_ramp	—	1.0	—	V	* ¹
	RAMP amplitude	dVramp	2.90	3.1	3.3	V	* ²
	RT voltage	V-rt	1.9	2.0	2.1	V	
Zero current detector	ZCD threshold voltage	Vzcd	–4	0	4	mV	
	Input bias current	Ics	–58	–42	–25	μA	Vcs = 0 V
Restart	Restart time delay	Tstart	75	150	330	μS	FB = 2.0 V, COMP = 2.5 V
Off time control	Minimum off time	Toff-min	1.0	1.4	1.8	μS	

Notes: *¹ Design spec*² dVramp = Vclamp_comp – Voff_ramp

Electrical Characteristics (cont.)

(Ta = 25°C, VCC = 12 V, CS = 0.1 V, FB = COMP, OVP2 = 0 V, RRT = 200 kΩ)

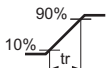
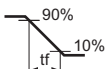
Item		Symbol	Min	Typ	Max	Unit	Test Conditions
Out	Rise time	tr-out	—	35	100	ns	CL = 1000 pF 
	Fall time	tf-out	—	35	100	ns	CL = 1000 pF 
	Out low voltage	Vol1-out	—	0.08	0.2	V	Isink = 20 mA
		Vol2-out	—	0.05	0.7	V	Isink = 10 mA, VCC = 5 V
Out high voltage	Voh-out	11.5	11.8	—	V	Isource = -20 mA	
Over current protection	OCP threshold voltage	Vocp	-0.63	-0.6	-0.57	V	
Over & Under voltage protection	Dynamic OVP threshold voltage	Vdovp	—	Vfb× 1.040	—	V	*1
	Dynamic UVP threshold voltage	Vduvp	—	Vfb× 0.920	—	V	*1
	Static OVP threshold voltage	Vsovp	Vfb× 1.075	Vfb× 1.090	Vfb× 1.105	V	
	Static OVP hysteresis	Hys-sovp	50	100	150	mV	
	FB low detect threshold voltage	Vfblow	0.25	0.3	0.35	V	
	FB low detect hysteresis	Hysfblow	0.16	0.20	0.24	V	
	OVP2 threshold voltage	Vovp2	Vfb× 1.075	Vfb× 1.090	Vfb× 1.105	V	
	OVP2 source current	Isrc-ovp2	-0.40	-0.15	-0.05	μA	

Note: *1 Design spec

Waveforms

1. Start-up

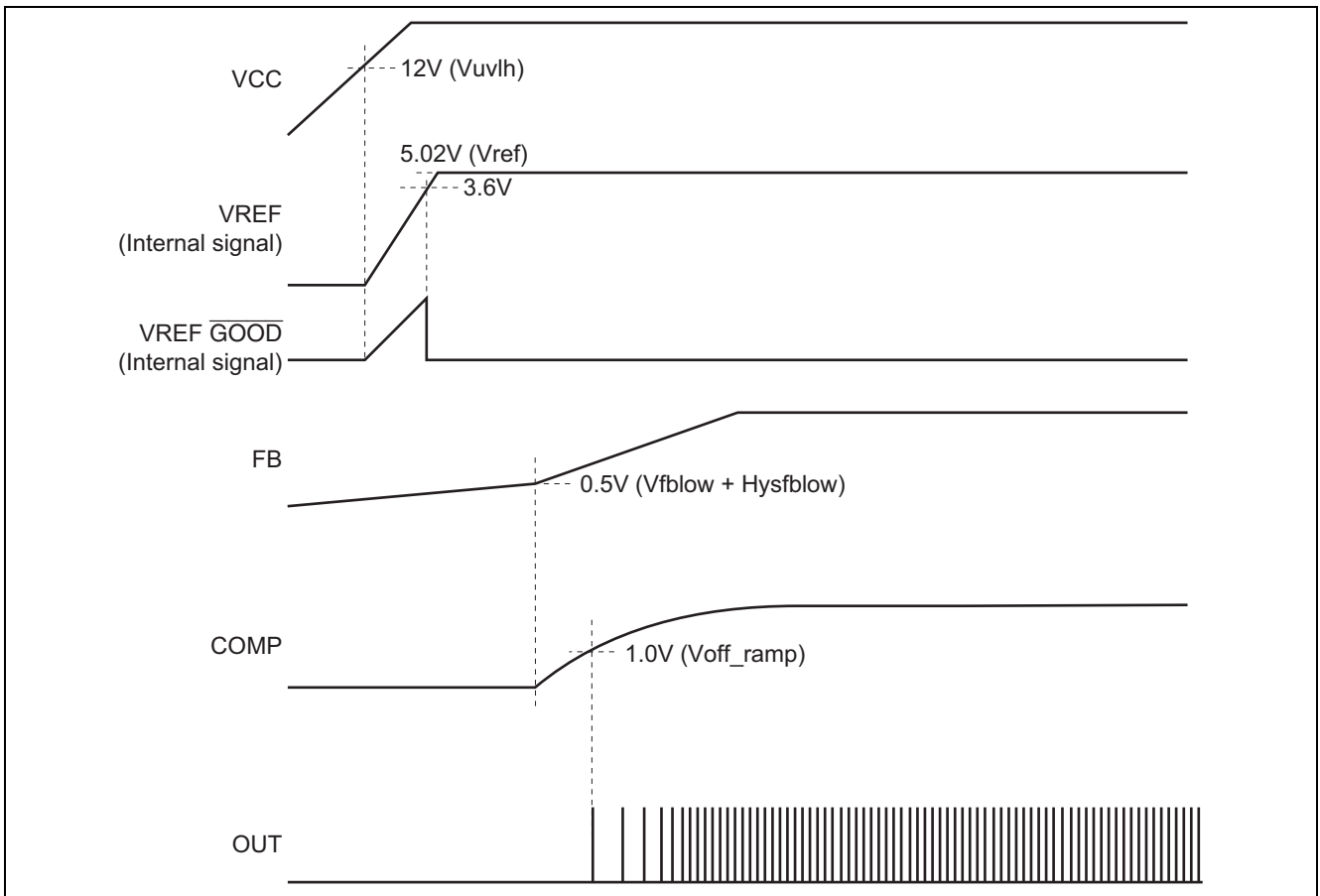

2. Shut-down

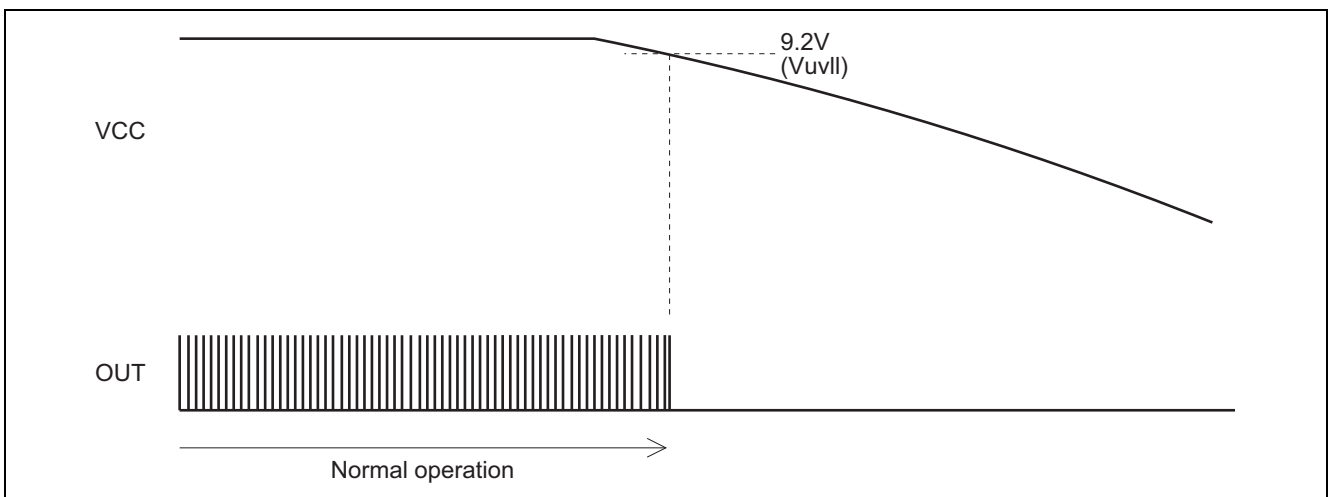

3. Gate Drive Output

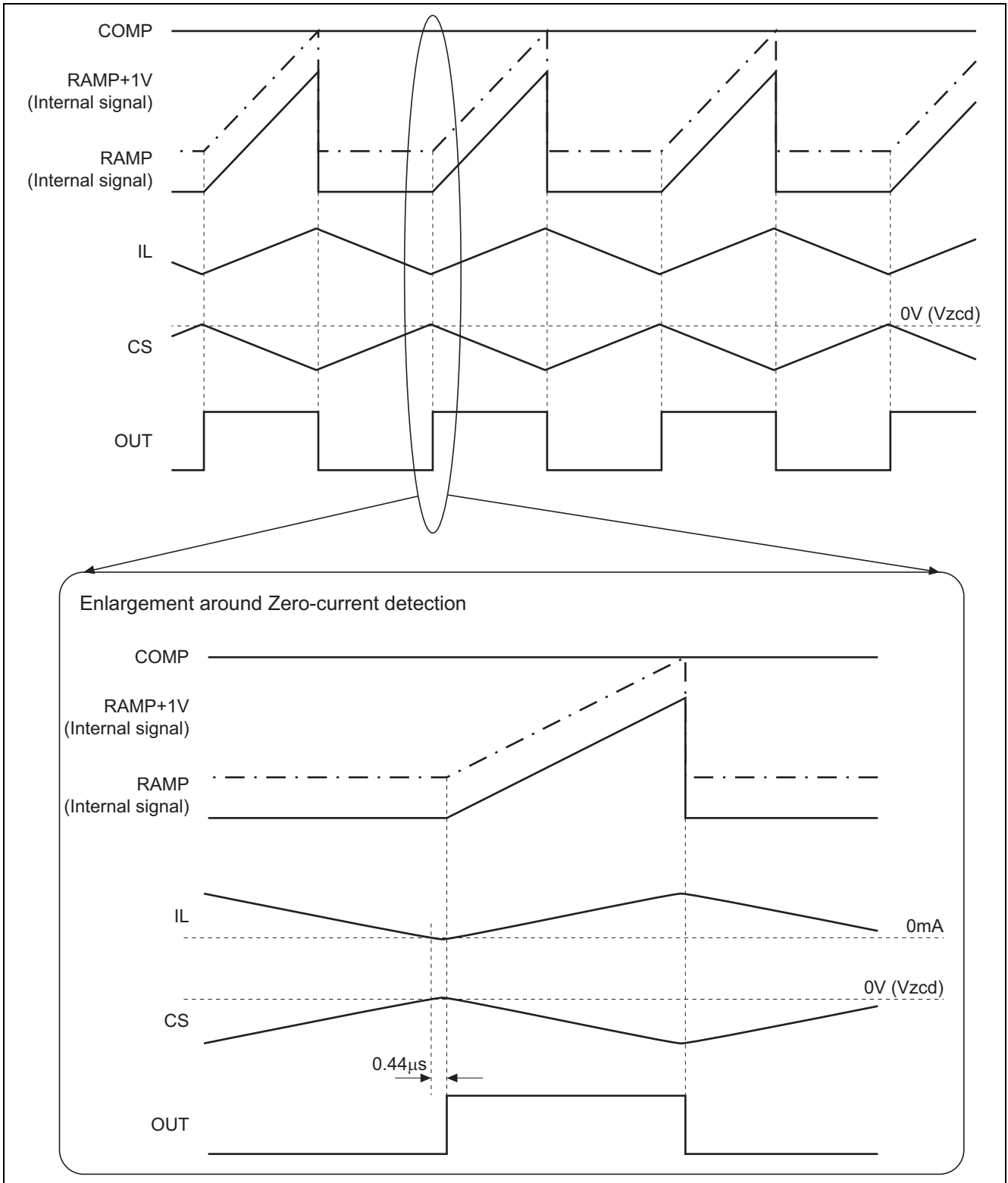

4. Overvoltage Protection (OVP)

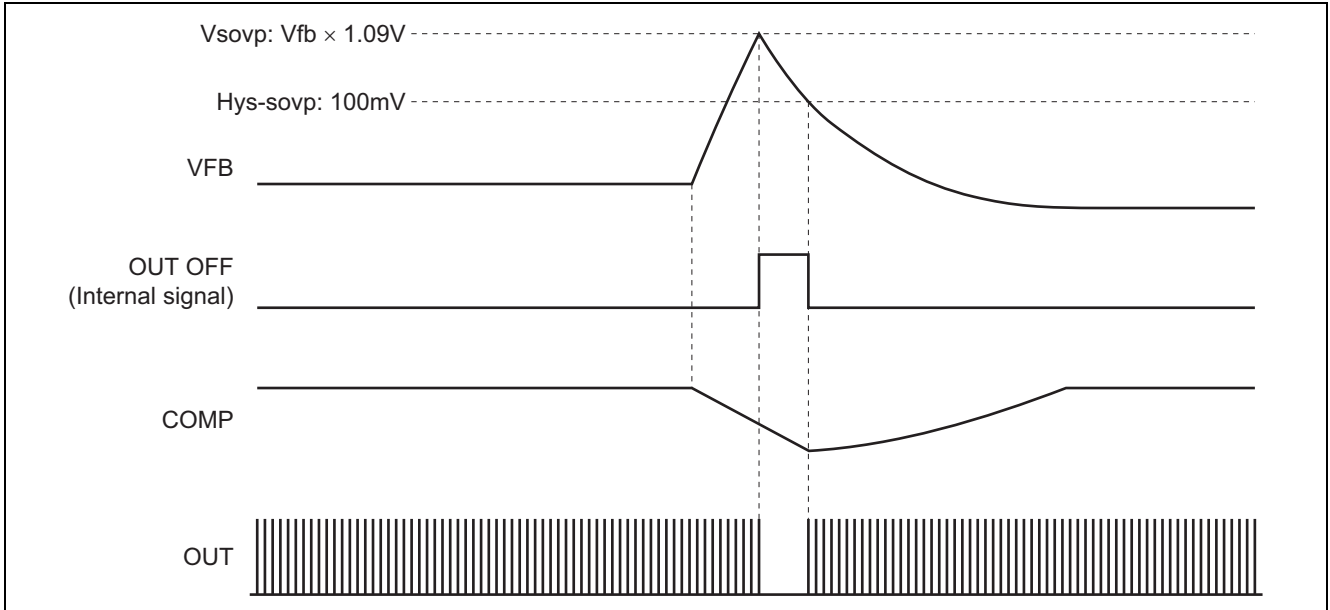

5. FB Low Detection

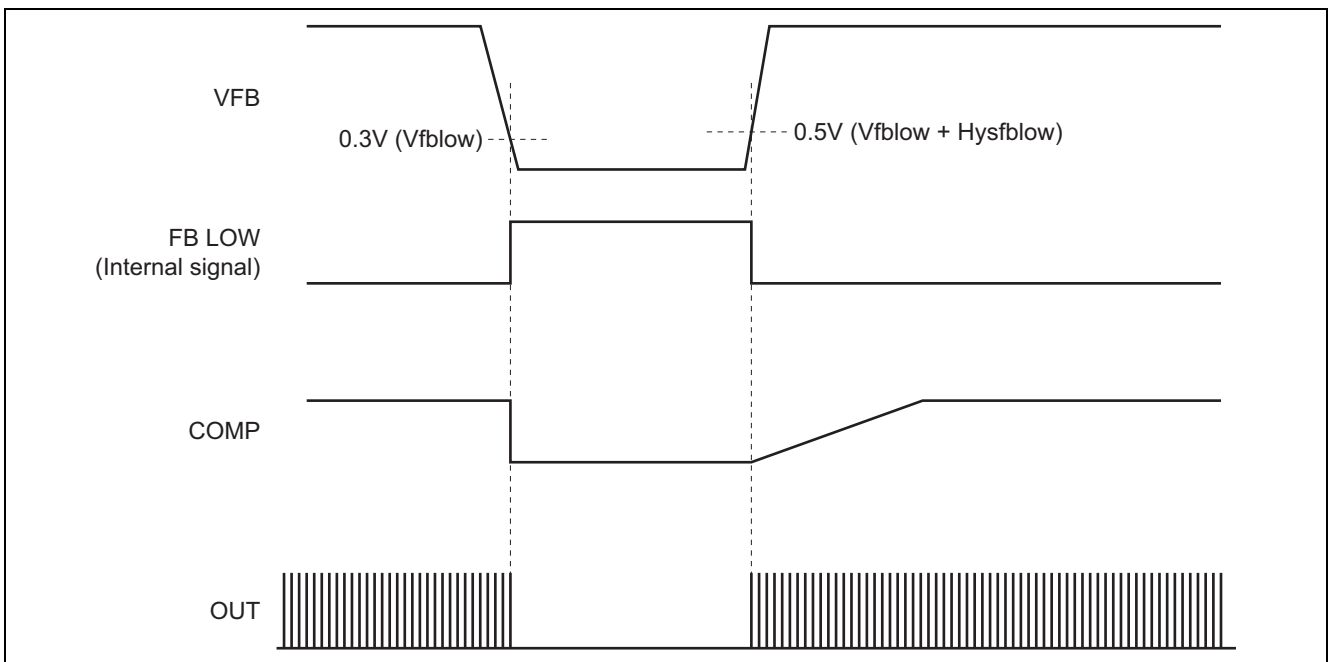

6. Overcurrent Protection (OCP)

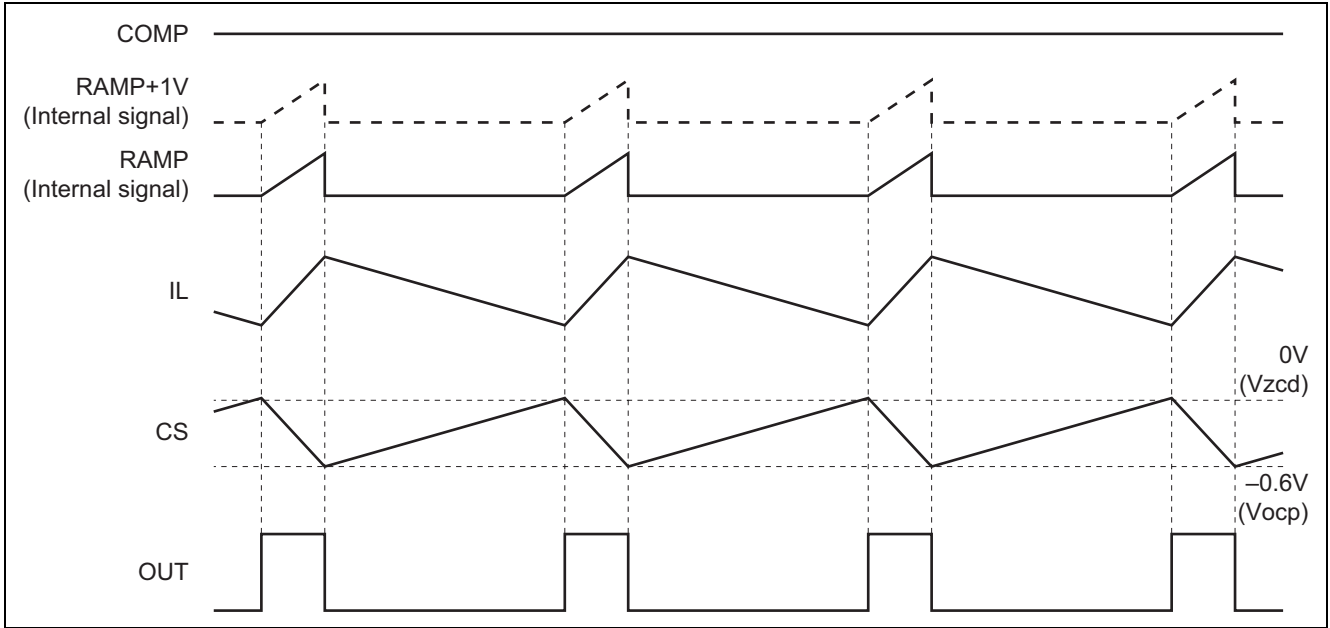

7. Off Time Control (Frequency Limiter)

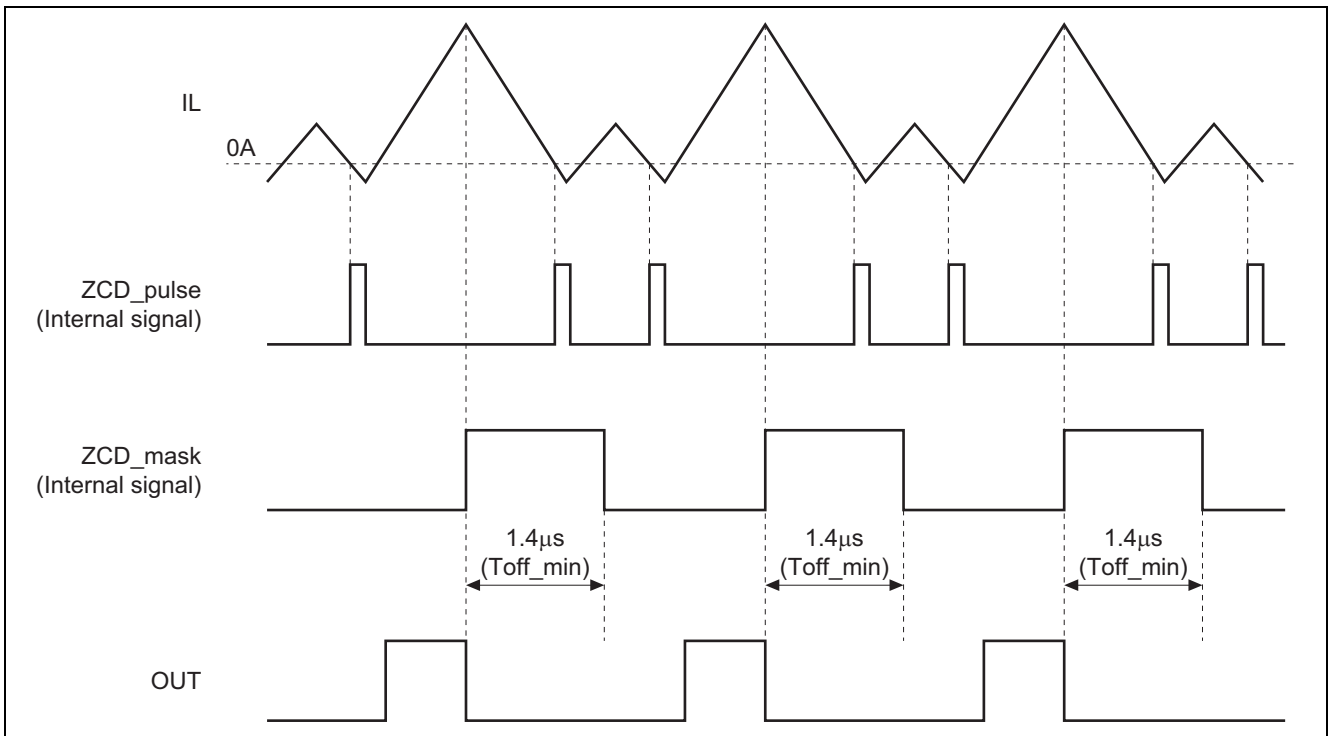

8. Overvoltage Protection 2 (OVP2)

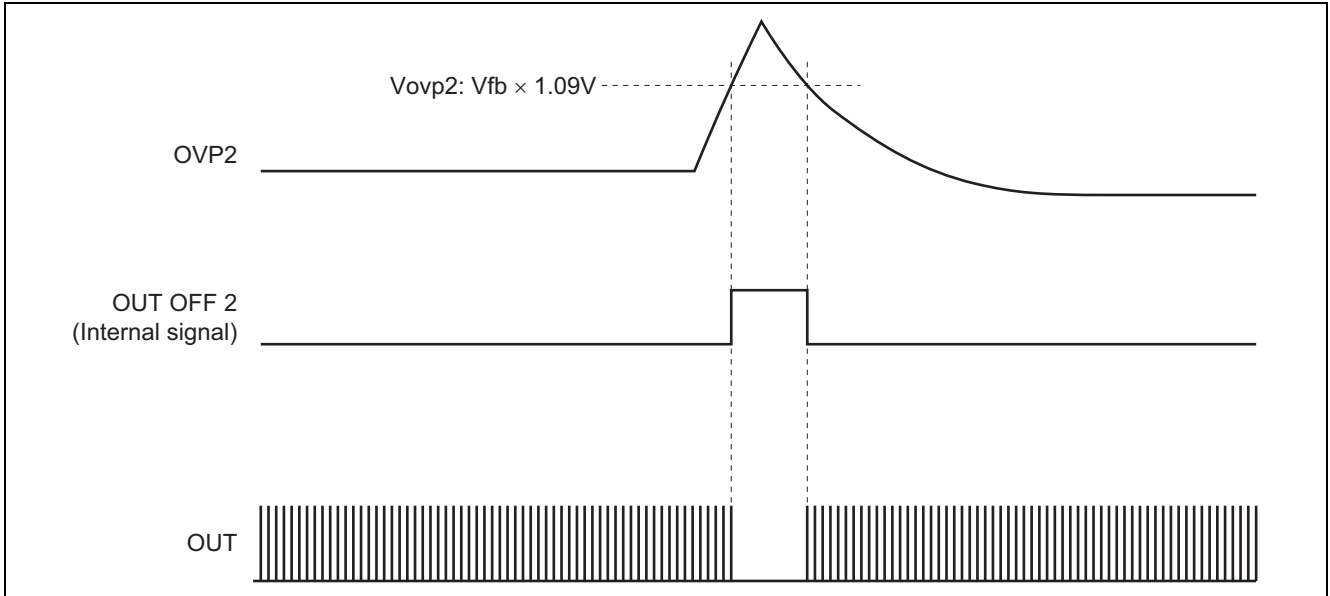

System Diagram

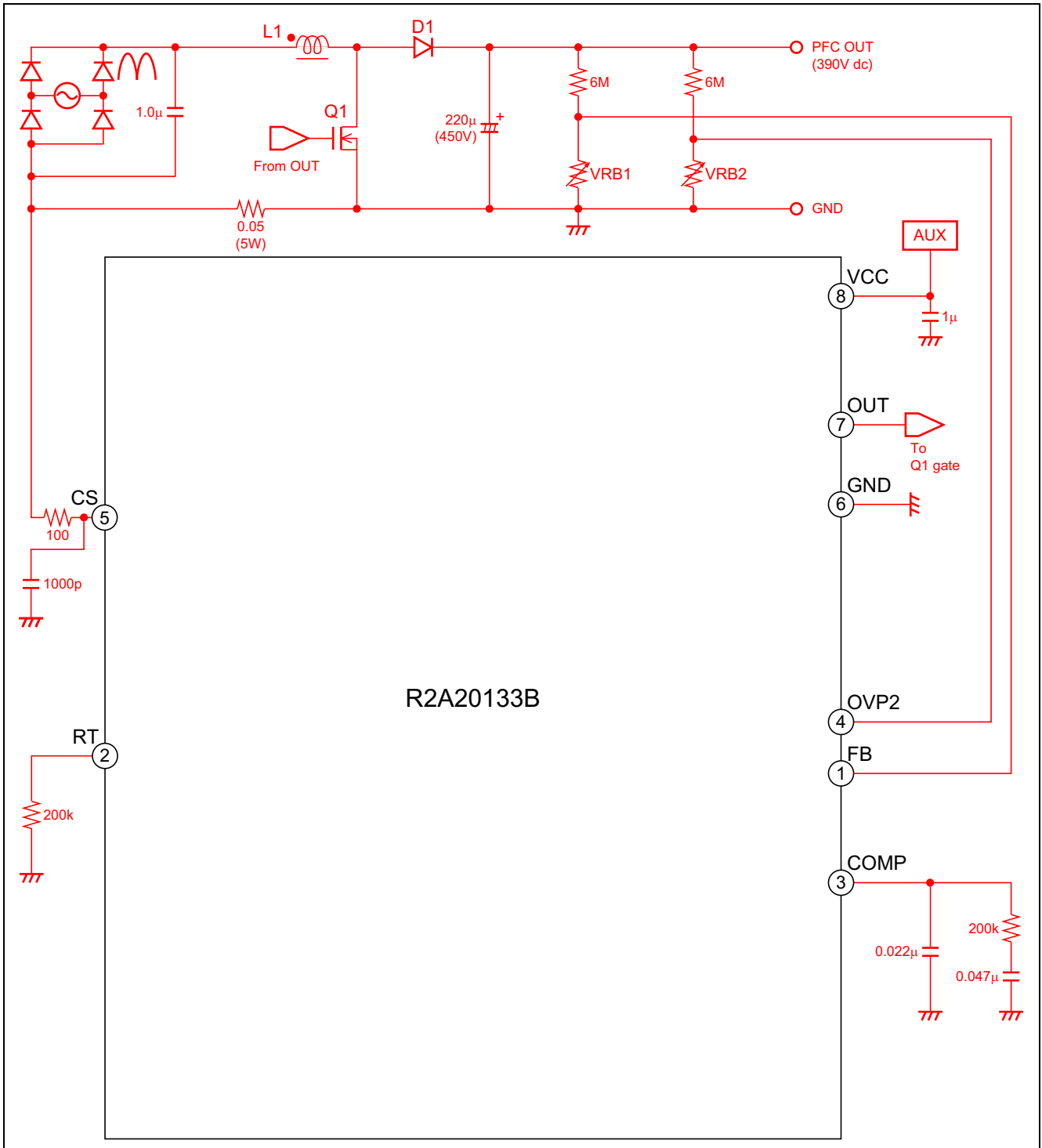

Package Dimensions

JEITA Package Code	RENESAS Code	Previous Code	MASS[Typ.]
P-SOP8-3.94x4.93-1.27	PRSP0008DJ-A	—	0.073g

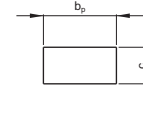
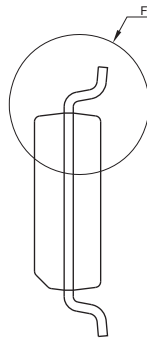
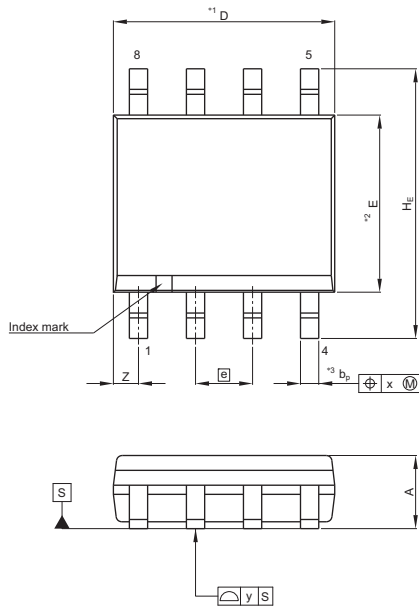

Terminal cross section
(Ni/Pd/Au plating)

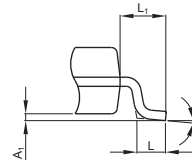

Detail F

NOTE)
1. DIMENSIONS*1 (Nom)*AND*2*
DO NOT INCLUDE MOLD FLASH.
2. DIMENSION*3*DOES NOT
INCLUDE TRIM OFFSET.

Reference Symbol	Dimension in Millimeters		
	Min	Nom	Max
D	4.80	4.93	4.98
E	3.81	3.94	3.99
A ₂	—	1.47	—
A ₁	0.10	0.15	0.25
A	—	—	1.73
b _p	0.35	0.41	0.49
b ₁	—	—	—
c	0.19	0.20	0.25
c ₁	—	—	—
θ	0°	—	8°
H _E	5.84	5.99	6.20
e	—	1.27	—
x	—	—	0.25
y	—	—	0.10
Z	—	0.56	—
L	0.41	0.64	0.89
L ₁	—	1.03	—

Notice

1. Descriptions of circuits, software and other related information in this document are provided only to illustrate the operation of semiconductor products and application examples. You are fully responsible for the incorporation of these circuits, software, and information in the design of your equipment. Renesas Electronics assumes no responsibility for any losses incurred by you or third parties arising from the use of these circuits, software, or information.
 2. Renesas Electronics has used reasonable care in preparing the information included in this document, but Renesas Electronics does not warrant that such information is error free. Renesas Electronics assumes no liability whatsoever for any damages incurred by you resulting from errors in or omissions from the information included herein.
 3. Renesas Electronics does not assume any liability for infringement of patents, copyrights, or other intellectual property rights of third parties by or arising from the use of Renesas Electronics products or technical information described in this document. No license, express, implied or otherwise, is granted hereby under any patents, copyrights or other intellectual property rights of Renesas Electronics or others.
 4. You should not alter, modify, copy, or otherwise misappropriate any Renesas Electronics product, whether in whole or in part. Renesas Electronics assumes no responsibility for any losses incurred by you or third parties arising from such alteration, modification, copy or otherwise misappropriation of Renesas Electronics product.
 5. Renesas Electronics products are classified according to the following two quality grades: "Standard" and "High Quality". The recommended applications for each Renesas Electronics product depends on the product's quality grade, as indicated below.
"Standard": Computers; office equipment; communications equipment; test and measurement equipment; audio and visual equipment; home electronic appliances; machine tools; personal electronic equipment; and industrial robots etc.
"High Quality": Transportation equipment (automobiles, trains, ships, etc.); traffic control systems; anti-disaster systems; anti-crime systems; and safety equipment etc.
Renesas Electronics products are neither intended nor authorized for use in products or systems that may pose a direct threat to human life or bodily injury (artificial life support devices or systems, surgical implantations etc.), or may cause serious property damages (nuclear reactor control systems, military equipment etc.). You must check the quality grade of each Renesas Electronics product before using it in a particular application. You may not use any Renesas Electronics product for any application for which it is not intended. Renesas Electronics shall not be in any way liable for any damages or losses incurred by you or third parties arising from the use of any Renesas Electronics product for which the product is not intended by Renesas Electronics.
 6. You should use the Renesas Electronics products described in this document within the range specified by Renesas Electronics, especially with respect to the maximum rating, operating supply voltage range, movement power voltage range, heat radiation characteristics, installation and other product characteristics. Renesas Electronics shall have no liability for malfunctions or damages arising out of the use of Renesas Electronics products beyond such specified ranges.
 7. Although Renesas Electronics endeavors to improve the quality and reliability of its products, semiconductor products have specific characteristics such as the occurrence of failure at a certain rate and malfunctions under certain use conditions. Further, Renesas Electronics products are not subject to radiation resistance design. Please be sure to implement safety measures to guard them against the possibility of physical injury, and injury or damage caused by fire in the event of the failure of a Renesas Electronics product, such as safety design for hardware and software including but not limited to redundancy, fire control and malfunction prevention, appropriate treatment for aging degradation or any other appropriate measures. Because the evaluation of microcomputer software alone is very difficult, please evaluate the safety of the final products or systems manufactured by you.
 8. Please contact a Renesas Electronics sales office for details as to environmental matters such as the environmental compatibility of each Renesas Electronics product. Please use Renesas Electronics products in compliance with all applicable laws and regulations that regulate the inclusion or use of controlled substances, including without limitation, the EU RoHS Directive. Renesas Electronics assumes no liability for damages or losses occurring as a result of your noncompliance with applicable laws and regulations.
 9. Renesas Electronics products and technology may not be used for or incorporated into any products or systems whose manufacture, use, or sale is prohibited under any applicable domestic or foreign laws or regulations. You should not use Renesas Electronics products or technology described in this document for any purpose relating to military applications or use by the military, including but not limited to the development of weapons of mass destruction. When exporting the Renesas Electronics products or technology described in this document, you should comply with the applicable export control laws and regulations and follow the procedures required by such laws and regulations.
 10. It is the responsibility of the buyer or distributor of Renesas Electronics products, who distributes, disposes of, or otherwise places the product with a third party, to notify such third party in advance of the contents and conditions set forth in this document, Renesas Electronics assumes no responsibility for any losses incurred by you or third parties as a result of unauthorized use of Renesas Electronics products.
 11. This document may not be reproduced or duplicated in any form, in whole or in part, without prior written consent of Renesas Electronics.
 12. Please contact a Renesas Electronics sales office if you have any questions regarding the information contained in this document or Renesas Electronics products, or if you have any other inquiries.
- (Note 1) "Renesas Electronics" as used in this document means Renesas Electronics Corporation and also includes its majority-owned subsidiaries.
(Note 2) "Renesas Electronics product(s)" means any product developed or manufactured by or for Renesas Electronics.



SALES OFFICES

Renesas Electronics Corporation

<http://www.renesas.com>

Refer to "<http://www.renesas.com/>" for the latest and detailed information.

Renesas Electronics America Inc.
2880 Scott Boulevard Santa Clara, CA 95050-2554, U.S.A.
Tel: +1-408-588-6000, Fax: +1-408-588-6130

Renesas Electronics Canada Limited
1101 Nicholson Road, Newmarket, Ontario L3Y 9C3, Canada
Tel: +1-905-898-5441, Fax: +1-905-898-3220

Renesas Electronics Europe Limited
Dukes Meadow, Millboard Road, Bourne End, Buckinghamshire, SL8 5FH, U.K.
Tel: +44-1628-651-700, Fax: +44-1628-651-804

Renesas Electronics Europe GmbH
Arcadiastrasse 10, 40472 Düsseldorf, Germany
Tel: +49-211-65030, Fax: +49-211-6503-1327

Renesas Electronics (China) Co., Ltd.
7th Floor, Quantum Plaza, No.27 ZhiChunLu Haidian District, Beijing 100083, P.R.China
Tel: +86-10-8235-1155, Fax: +86-10-8235-7679

Renesas Electronics (Shanghai) Co., Ltd.
Unit 204, 205, AZIA Center, No.1233 Lujiazui Ring Rd., Pudong District, Shanghai 200120, China
Tel: +86-21-5877-1818, Fax: +86-21-6887-7858 / -7898

Renesas Electronics Hong Kong Limited
Unit 1601-1613, 16/F., Tower 2, Grand Century Place, 193 Prince Edward Road West, Mongkok, Kowloon, Hong Kong
Tel: +852-2886-9318, Fax: +852 2886-9022/9044

Renesas Electronics Taiwan Co., Ltd.
13F, No. 363, Fu Shing North Road, Taipei, Taiwan
Tel: +886-2-8175-9600, Fax: +886 2-8175-9670

Renesas Electronics Singapore Pte. Ltd.
80 Bendemeer Road, Unit #06-02 Hyflux Innovation Centre Singapore 339949
Tel: +65-6213-0200, Fax: +65-6213-0300

Renesas Electronics Malaysia Sdn.Bhd.
Unit 906, Block B, Menara Amcorp, Amcorp Trade Centre, No. 18, Jln Persiaran Barat, 46050 Petaling Jaya, Selangor Darul Ehsan, Malaysia
Tel: +60-3-7955-3390, Fax: +60-3-7955-9510

Renesas Electronics Korea Co., Ltd.
11F., Samik Laved. or Bldg., 720-2 Yeoksam-Dong, Kangnam-Ku, Seoul 135-080, Korea
Tel: +82-2-558-3737, Fax: +82-2-558-5141