

# DATA SHEET



## **TEA6886HL**

**Up-level Car radio Analog Signal  
Processor (CASP)**

Product specification  
Supersedes data of 2000 Nov 21

2003 Feb 04

# Up-level Car radio Analog Signal Processor (CASP)

## TEA6886HL

<b>CONTENTS</b>	12	INTERNAL CIRCUITRY	
1	FEATURES	13	TEST CIRCUIT
1.1	General	14	PACKAGE OUTLINE
1.2	Stereo decoder and noise blanking	15	SOLDERING
1.3	Weak signal processing	15.1	Introduction to soldering surface mount packages
1.4	Audio pre-amplifier	15.2	Reflow soldering
2	GENERAL DESCRIPTION	15.3	Wave soldering
3	ORDERING INFORMATION	15.4	Manual soldering
4	QUICK REFERENCE DATA	15.5	Suitability of surface mount IC packages for wave and reflow soldering methods
5	BLOCK DIAGRAM	16	DATA SHEET STATUS
6	PINNING	17	DEFINITIONS
7	FUNCTIONAL DESCRIPTION	18	DISCLAIMERS
7.1	Stereo decoder	19	PURCHASE OF PHILIPS I <sup>2</sup> C COMPONENTS
7.2	FM noise blanker		
7.3	AM noise blanker		
7.4	Multipath/fading detection and weak signal control		
7.5	Tone/volume control		
7.5.1	Source selector		
7.5.2	Loudness		
7.5.3	Volume 1		
7.5.4	Treble		
7.5.5	Bass		
7.5.6	Volume 2		
7.5.7	RSA selector		
7.5.8	Chime adder		
8	LIMITING VALUES		
9	THERMAL CHARACTERISTICS		
10	CHARACTERISTICS		
11	I <sup>2</sup> C-BUS PROTOCOL		
11.1	Read mode: 1st data byte		
11.2	Read mode: 2nd data byte		
11.3	Subaddress byte for write		
11.4	Write mode: subaddress 0H		
11.5	Write mode: subaddress 1H		
11.6	Write mode: subaddress 2H		
11.7	Write mode: subaddress 3H		
11.8	Write mode: subaddress 4H		
11.9	Write mode: subaddress 5H		
11.10	Write mode: subaddress 6H		
11.11	Write mode: subaddress 7H		
11.12	Write mode: subaddress 8H		
11.13	Write mode: subaddress 9H		
11.14	Write mode: subaddress AH		
11.15	Write mode: subaddress BH		
11.16	Write mode: subaddress CH		

# Up-level Car radio Analog Signal Processor (CASP)

TEA6886HL

## 1 FEATURES

### 1.1 General

- I<sup>2</sup>C-bus compatible
- Digital alignment/adjustment via I<sup>2</sup>C-bus:
  - FM noise blanker sensitivity
  - FM stereo noise canceller
  - FM High Cut Control (HCC)
  - FM stereo separation.
- FM audio processing hold for RDS updating; holds the detectors for the FM weak signal processing in their present state
- FM bandwidth limiting; limits the bandwidth of the FM audio signal with external capacitors
- AM stereo input; AM stereo audio can be fed in at the pins for the de-emphasis capacitors; this will provide 8 dB of gain to the AM audio.

### 1.2 Stereo decoder and noise blanking

- FM stereo decoder
- Accepts FM multiplex signal and AM audio at input
- Pilot detector and pilot canceller
- De-emphasis selectable between 75 and 50  $\mu$ s
- AM noise blanker: impulse noise detector and an audio hold.

### 1.3 Weak signal processing

- FM weak signal processing: six signal condition detectors, soft mute, stereo noise canceller (blend) and high cut control (roll-off).

### 1.4 Audio pre-amplifier

- Source selector for 6 sources: 2 stereo inputs external (A and B), 1 symmetrical stereo input (C), 1 symmetrical mono input (D), 1 internal stereo input (AM or FM) and 1 chime/diagnostic mono input



- Volume 1 control from +20 to –56 dB in 1 dB steps; programmable 20 dB loudness control included
- Volume 2 control from 0 to –56 dB in 1 dB steps, –56, –58.5, –62, –68 dB and mute
- Programmable loudness control with bass boost as well as bass and treble boost
- Treble control from –14 to +14 dB in 2 dB steps
- Bass control from –18 to +18 dB in 2 dB steps with selectable characteristic
- Analog Step Interpolation (ASI) minimizes pops by smoothing out the transitions in the audio signal when a switch is made
- Audio Blend Control (ABC) minimizes pops by automatically incrementing the volume and loudness controls through each step between their present settings and the new settings
- Rear Seat Audio (RSA) can select different sources for the front and rear speakers
- Chime input: can be sent to any audio output, at any volume level
- Chime adder circuit: chime input can also be summed with left front and/or right front audio, or be turned off.

## 2 GENERAL DESCRIPTION

The TEA6886HL is a monolithic bipolar integrated circuit providing the stereo decoder function and ignition noise blanking facility combined with source selector and tone/volume control for AM/FM car radio applications. The device operates with a power supply voltage range from 7.8 to 9.2 V and a typical current consumption of 40 mA.

## 3 ORDERING INFORMATION

TYPE NUMBER	PACKAGE		
	NAME	DESCRIPTION	VERSION
TEA6886HL	LQFP80	plastic low profile quad flat package; 80 leads; body 12 × 12 × 1.4 mm	SOT315-1

# Up-level Car radio Analog Signal Processor (CASP)

TEA6886HL

## 4 QUICK REFERENCE DATA

SYMBOL	PARAMETER	CONDITIONS	MIN.	TYP.	MAX.	UNIT
$V_{CC}$	supply voltage		7.8	8.5	9.2	V
$I_{CC}$	supply current		32	40	48	mA
<b>Stereo decoder path</b>						
S/N	signal-to-noise ratio		–	78	–	dB
THD	total harmonic distortion		–	0.1	–	%
$\alpha_{CS}$	channel separation		40	–	–	dB
$V_{o(rms)}$	output voltage level at pins ROPO and LOPO (RMS value)	FM: 91% modulation; AM: 100% modulation; $f_{mod} = 400$ Hz	840	950	1060	mV
<b>Tone/volume control</b>						
$V_{o(max)(rms)}$	maximum output voltage level at pins LF, LR, RF and RR (RMS value)	$V_{CC} = 8.5$ V; THD $\leq 0.1\%$	2000	–	–	mV
$G_V$	voltage gain	1 dB steps	–112	–	+20	dB
$G_{step(vol)}$	step resolution (volume)		–	1	–	dB
$G_{bass}$	bass control		–18	–	+18	dB
$G_{treble}$	treble control		–14	–	+14	dB
$G_{step(treble, bass)}$	step resolution (bass and treble)		–	2	–	dB
(S+N)/N	signal-plus-noise to noise ratio	$V_o = 2.0$ V; $G_V = 0$ dB; unweighted	–	107	–	dB
THD	total harmonic distortion	$V_{o(rms)} = 1.0$ V; $G_V = 0$ dB	–	0.01	–	%
RR <sub>100</sub>	ripple rejection	$V_{ripple(rms)} < 200$ mV; $f = 100$ Hz; $G_V = 0$ dB	–	70	–	dB
CMRR	common mode rejection ratio differential stereo input		48	53	–	dB

# Up-level Car radio Analog Signal Processor (CASP)

# TEA6886HL

## 5 BLOCK DIAGRAM

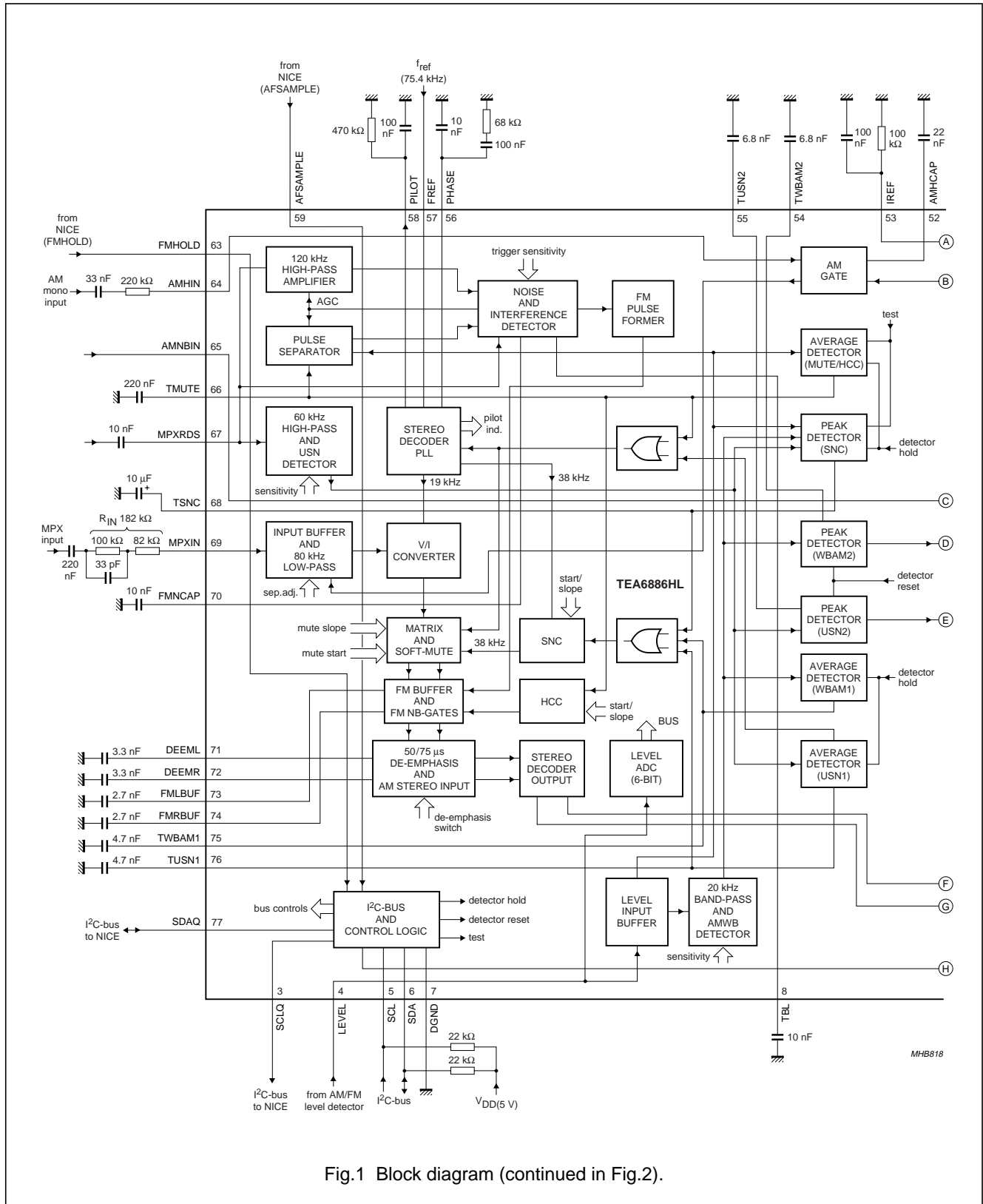

Fig.1 Block diagram (continued in Fig.2).

# Up-level Car radio Analog Signal Processor (CASP)

## TEA6886HL

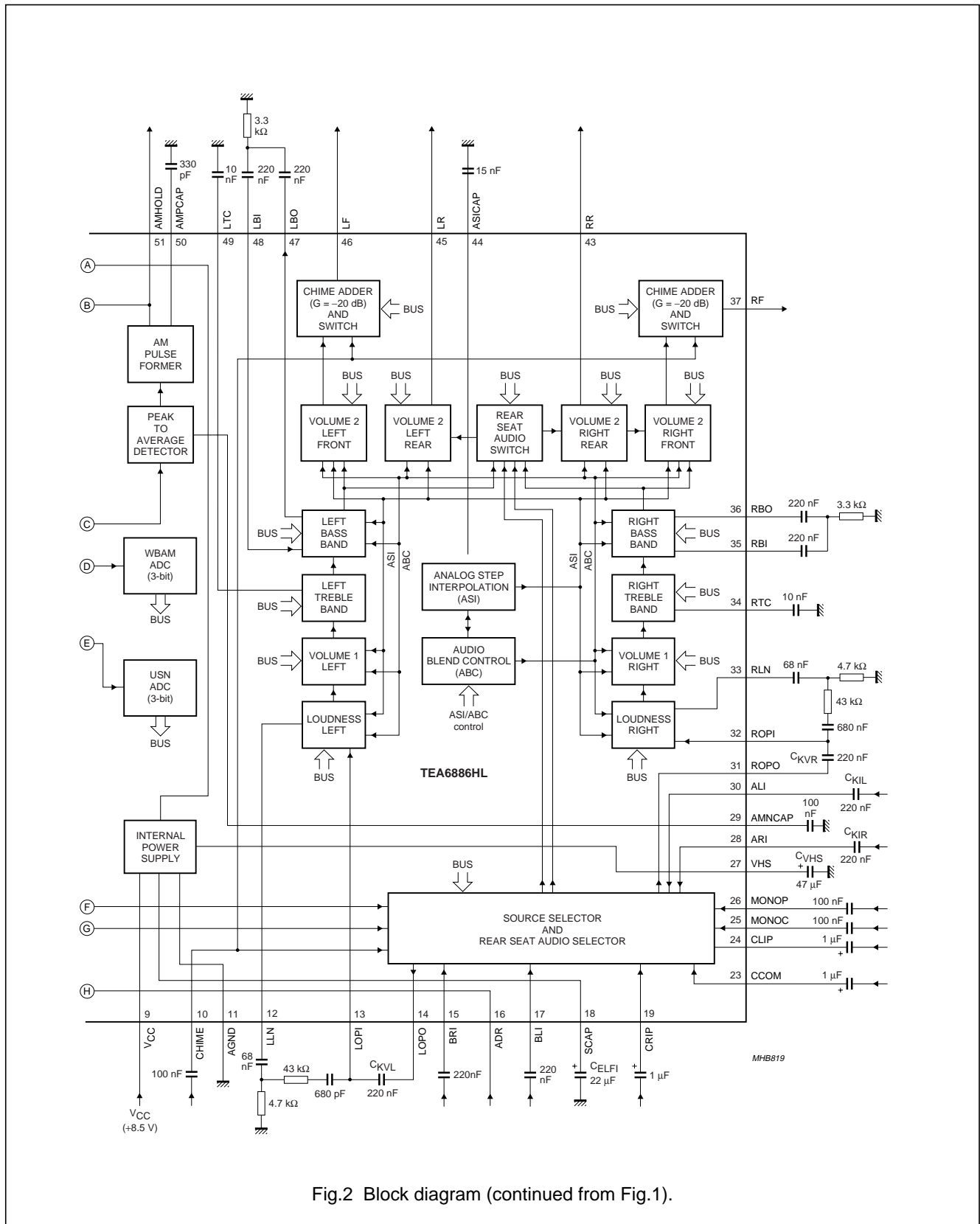

Fig.2 Block diagram (continued from Fig.1).

# Up-level Car radio Analog Signal Processor (CASP)

TEA6886HL

## 6 PINNING

SYMBOL	PIN	DESCRIPTION
n.c.	1	not connected
n.c.	2	not connected
SCLQ	3	clock output (to TEA6840H)
LEVEL	4	FM and AM level input (from TEA6840H)
SCL	5	I <sup>2</sup> C-bus clock input
SDA	6	I <sup>2</sup> C-bus data input/output
DGND	7	digital ground
TBL	8	time constant for FM modulation detector
V <sub>CC</sub>	9	supply voltage
CHIME	10	chime tone input
AGND	11	analog ground
LLN	12	loudness left network
LOPI	13	left option port input (terminal impedance typical 100 kΩ)
LOPO	14	left option port output
BRI	15	channel B right stereo input (terminal impedance typical 100 kΩ)
ADR	16	address select input
BLI	17	channel B left stereo input (terminal impedance typical 100 kΩ)
SCAP	18	supply filter capacitor
CRIP	19	channel C right symmetrical input (terminal impedance typical 30 kΩ)
n.c.	20	not connected
n.c.	21	not connected
n.c.	22	not connected
CCOM	23	channel C common input (terminal impedance typical 30 kΩ)
CLIP	24	channel C left symmetrical input (terminal impedance typical 30 kΩ)
MONOC	25	mono common input (terminal impedance typical 30 kΩ)
MONOP	26	mono symmetrical input (terminal impedance typical 30 kΩ)
VHS	27	half supply filter capacitor
ARI	28	channel A right stereo input (terminal impedance typical 100 kΩ)
AMNCAP	29	peak-to-average detector capacitor for AM noise blanker
ALI	30	channel A left stereo input (terminal impedance typical 100 kΩ)
ROPO	31	right option port output
ROPI	32	right option port input (terminal impedance typical 100 kΩ)
RLN	33	loudness right network
RTC	34	right treble capacitor
RBI	35	right bass network input
RBO	36	right bass network output
RF	37	right front output
n.c.	38	not connected
n.c.	39	not connected
n.c.	40	not connected

## Up-level Car radio Analog Signal Processor (CASP)

TEA6886HL

SYMBOL	PIN	DESCRIPTION
n.c.	41	not connected
n.c.	42	not connected
RR	43	right rear output
ASICAP	44	analog step interpolate capacitor
LR	45	left rear output
LF	46	left front output
LBO	47	left bass network output
LBI	48	left bass network input
LTC	49	left treble capacitor
AMPCAP	50	AM blanking time capacitor
AMHOLD	51	AM noise blanker flag
AMHCAP	52	AM noise blanker hold capacitor
IREF	53	temperature independent reference current
TWBAM2	54	time constant for AM wideband peak detector
TUSN2	55	time constant for ultrasonic noise peak detector
PHASE	56	phase detector
FREF	57	frequency reference input (75.4 kHz from TEA6840H)
PILOT	58	pilot on/off output
AFSAMPLE	59	reset for multipath detector (from TEA6840H for RDS update)
n.c.	60	not connected
n.c.	61	not connected
n.c.	62	not connected
FMHOLD	63	FM audio processing hold input (from TEA6840H for RDS update)
AMHIN	64	AM signal input (from TEA6840H)
AMNBIN	65	AM noise blanker input (from TEA6840H)
TMUTE	66	time constant for soft mute
MPXRDS	67	unmuted MPX input (from TEA6840H for RDS update)
TSNC	68	time constant for stereo noise canceller
MPXIN	69	MPX input (from TEA6840H)
FMNCAP	70	FM noise detector capacitor
DEEML	71	left de-emphasis capacitor
DEEMR	72	right de-emphasis capacitor
FMLBUF	73	left AM/FM audio buffer capacitor
FMRBUF	74	right AM/FM audio buffer capacitor
TWBAM1	75	time constant for AM wideband average detector
TUSN1	76	time constant for ultrasonic noise average detector
SDAQ	77	data input/output (to TEA6840H)
n.c.	78	not connected
n.c.	79	not connected
n.c.	80	not connected



Up-level Car radio Analog Signal Processor (CASP)

TEA6886HL

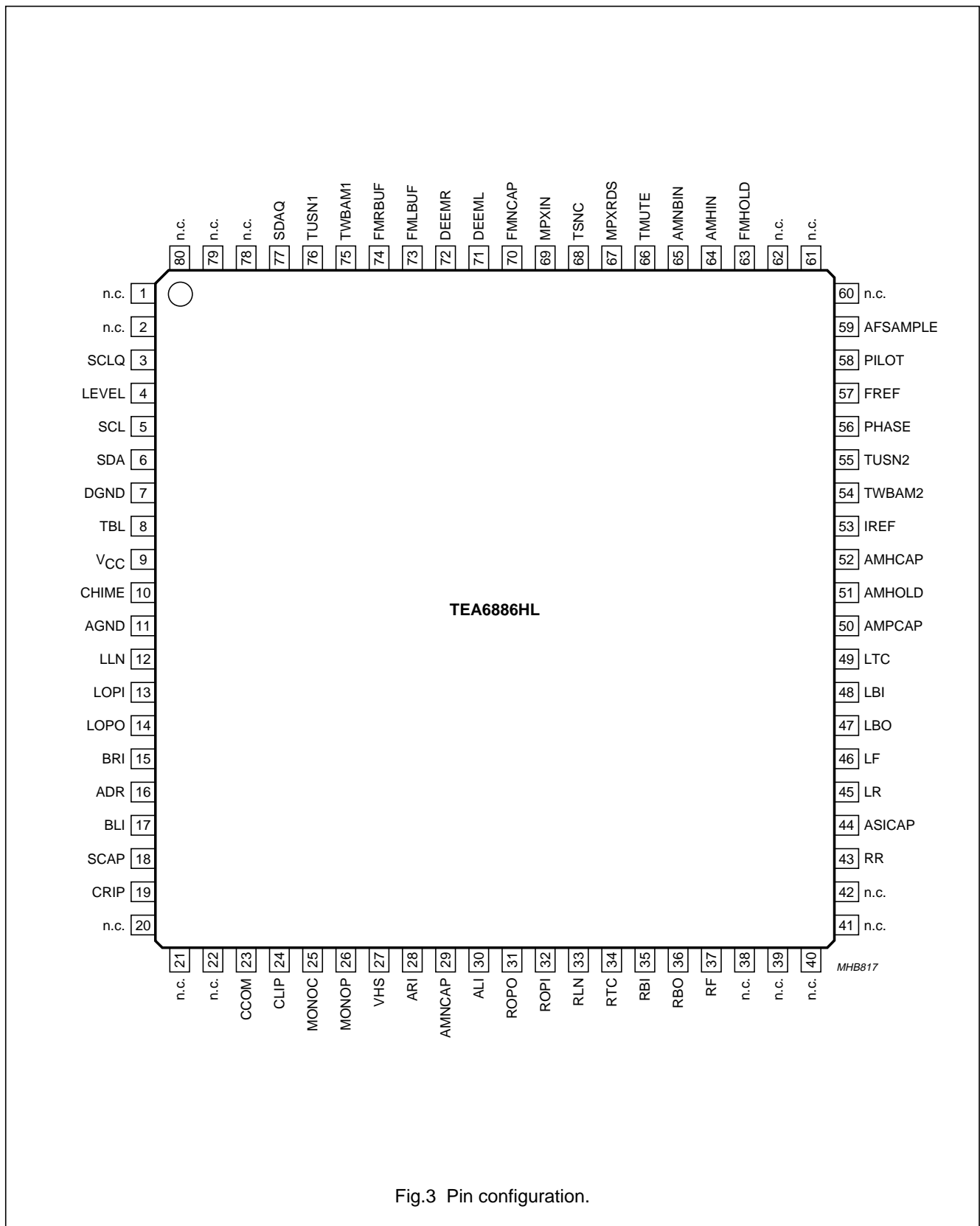

Fig.3 Pin configuration.

## Up-level Car radio Analog Signal Processor (CASP)

TEA6886HL

### 7 FUNCTIONAL DESCRIPTION

#### 7.1 Stereo decoder

The MPX input is the null-node of an operational amplifier with internal feedback resistor. Adapting the stereo decoder input to the level of the MPX signal, coming from the FM demodulator output, is realized by the value of the input series resistor  $R_{IN}$ . To this input a second source (AM detector output) can be fed by current addition.

The input amplifier is followed by an integrated 4th-order Bessel low-pass filter with a cut-off frequency of 80 kHz. It provides the necessary signal delay for FM noise blanking and damping of high frequency interference at the stereo decoder input.

The output signal of this filter is fed to the soft mute control circuitry, the output is voltage-to-current converted and then fed to the phase detector, pilot detector and pilot canceller circuits, contained in the stereo decoder PLL block. A PLL is used for regeneration of the 38 kHz subcarrier. The fully integrated oscillator is adjusted by means of a digital auxiliary PLL into the capture range of the main PLL. The auxiliary PLL needs an external reference frequency (75.4 kHz) which is provided by the TEA6840H. The required 19 and 38 kHz signals are generated by division of the oscillator output signal in a logic circuit. The 19 kHz quadrature phase signal is fed to the 19 kHz phase detector, where it is compared with the incoming pilot tone. The DC output signal of the phase detector controls the oscillator (PLL).

The pilot present detector is driven by an internally generated in-phase 19 kHz signal. Its pilot dependent DC output voltage is fed to a threshold switch, which activates the pilot indicator bit and switches the stereo decoder to stereo operation. The same DC voltage is used to control the amplitude of an anti-phase internally generated 19 kHz signal. The pilot tone is compensated by this anti-phase 19 kHz signal in the pilot canceller.

The pilot cancelled signal is fed to the matrix. There, the side signal is demodulated and combined with the main signal to the left and right audio channels. Compensation for roll-off in the incoming MPX signal caused by the IF filters and the FM demodulator is typically realized by an external compensation network at pin MPXIN, individual alignment is achieved by I<sup>2</sup>C-bus controlled amplification of the side signal (DAA). A smooth mono-to-stereo takeover is achieved by controlling the efficiency of the matrix with the help of the SNC peak detector.

The matrix is followed by the FM noise suppression gates, which are combined with FM single poles and High Cut Control (HCC).

The single pole is defined by internal resistors and external capacitors. Audio is fed from the gate circuits to the switchable de-emphasis, where the demodulated AM stereo signal can be fed in. After de-emphasis the signal passes to the output buffers and is fed to the radio input of the source selector. For HCC, the time constant of the single pole contained in the output buffer can be changed to higher values. This function is controlled by an average detector contained in the multipath and fading detector.

#### 7.2 FM noise blanker

The input of the ignition noise blanker is coupled to the MPXRDS input signal and to the LEVEL input. Both signals are fed via separate 120 kHz filters and rectifiers to an adder circuit. The output signal of the adder circuit is fed in parallel to the noise detector and the interference detector. The noise detector is a negative peak detector. Its output controls the trigger sensitivity (prevention of false triggering at noisy input signals) and the gain of the MPX high-pass filter. The output of the interference detector, when receiving a steep pulse, fires a single-shot trigger circuit, contained in the pulse former circuitry. The time constant of the single-shot trigger circuit is defined by an internal capacitor, and its output activates the blanking gates in the audio.

#### 7.3 AM noise blanker

The AM noise blanking pulse is derived from the AM audio signal which is fed into pin AMNBIN with the help of a peak-to-average comparator. The blanking time is set by a pulse former with external capacitor. The blanking pulse is fed to the gate in the AM audio path and out at pin AMHOLD to operate the gate built into the external AM stereo processor.

#### 7.4 Multipath/fading detection and weak signal control

For FM signal quality dependent controls there is a built-in combination of six detectors. These detectors are driven by the level information direct, by the AC components on the level via a 20 kHz band-pass filter (AM wideband) or by the high notes present at the FM demodulator output via a 60 kHz high-pass filter (ultrasonic noise). The relationship between the DC level and the AC components is programmable by the I<sup>2</sup>C-bus (2 bits each). The output of the level buffer, AM wideband detector and ultrasonic noise detector are analog-to-digital converted and readable by the I<sup>2</sup>C-bus.

## Up-level Car radio Analog Signal Processor (CASP)

TEA6886HL

For the period of fast RDS updating soft mute, SNC and HCC can be put on hold. The AM wideband peak detector and the ultrasonic noise peak detector are reset by a switch signal delivered from the TEA6840H via pin FMHOLD.

The six separate detecting circuits are as follows:

1. The AM wideband noise peak detector is driven from a 20 kHz band-pass filter connected to the level buffer output. The time constant is defined by an external capacitor connected to pin TWBAM2. The output voltage of the detector is analog-to-digital converted by a 3-bit ADC.
2. The AM wideband noise average detector is driven from a 20 kHz band-pass filter connected to the level buffer output. The time constant is defined by an external capacitor connected to pin TWBAM1. The output of the detector is connected to the Stereo Noise Control (SNC) circuit.
3. The ultrasonic noise peak detector is driven from a 60 kHz high-pass filter connected to the MPX signal from pin MPXRDS. The time constant is defined by an external capacitor connected to pin TUSN2. The output voltage of the detector is analog-to-digital converted by a 3-bit ADC.
4. The ultrasonic noise average detector is driven from a 60 kHz high-pass filter connected to the MPX signal from pin MPXRDS. The time constant is defined by an external capacitor connected to pin TUSN1. The output of the detector is connected to soft mute control and stereo noise control circuits.
5. For soft mute and high cut control purposes an average detector with an externally defined time constant (TMUTE) is provided. The detector is driven by level output only. Soft mute and high cut control can be switched off via the I<sup>2</sup>C-bus.
6. The stereo noise control peak detector with an externally defined time constant (TSNC) is driven by DC level output, AM wideband and ultrasonic noise outputs. It provides the stereo blend facility (SNC). The starting point and slope of the stereo blend can be chosen via the I<sup>2</sup>C-bus controlled reference voltage.

### 7.5 Tone/volume control

The tone/volume control part consists of the following functions:

- Source selector
- Loudness
- Volume 1
- Treble
- Bass
- Volume 2
- Rear Seat Audio (RSA) selector
- Chime adder
- Analog step interpolation
- Audio blend control.

The stages loudness, volume 1, bass and volume 2 include the Analog Step Interpolation (ASI) function. This minimizes pops by smoothing out the transitions in the audio signal during switching. The transition time is I<sup>2</sup>C-bus programmable in a range of 1 : 24 in four steps.

The stages loudness, volume 1 and volume 2 also have the Audio Blend Control (ABC) function. This minimizes pops by automatically incrementing the volume and loudness controls through each step between their present settings and the new settings. The speed of the ABC function is correlated with the transition time of the ASI function.

All stages are controlled via the I<sup>2</sup>C-bus.

## Up-level Car radio Analog Signal Processor (CASP)

TEA6886HL

### 7.5.1 SOURCE SELECTOR

The source selector allows the selection between 6 sources:

- 2 external stereo inputs (ALI, ARI, BLI and BRI)
- 1 external symmetrical stereo input (CLIP, CRIP and CCOM)
- 1 external symmetrical mono input (MONOP and MONON)
- 1 internal stereo input (AM/FM)
- 1 chime/diagnostic mono input (CHIME).

A chime input signal can be sent to any audio output, at any volume level, via the chime/diagnostic mono input.

### 7.5.2 LOUDNESS

The output of the source selector is fed into the loudness circuit via the external capacitor  $C_{KVL}$  (between pins LOPO and LOPI) and  $C_{KVR}$  (between pins ROPO and ROPI). Depending on the external circuits for the left and the right channel, only a bass boost or bass and treble boost is available. The external circuits illustrated in Figs 13 and 15 will produce the curves illustrated in Figs 14 and 16 (without the influence of  $C_{KVL}$  and  $C_{KVR}$  respectively).

### 7.5.3 VOLUME 1

The volume 1 control circuit follows the loudness circuit. The control range of volume 1 is between +20 and -36 dB in steps of 1 dB.

### 7.5.4 TREBLE

The output signal of the volume 1 control circuit is fed into the treble control stage. The control range is between +14 and -14 dB in steps of 2 dB. Fig.20 shows the control characteristic with external capacitors of 10 nF.

### 7.5.5 BASS

The bass control is the next stage. The characteristic of the bass curves depends upon the external circuits connected to pins LBO and LBI (left channel) and pins RBO and RBI (right channel) and also upon the setting of bit BSYM (MSB of the bass control byte). When BSYM = 1, an equalizer characteristic is obtained and when BSYM = 0, a shelving characteristic is obtained.

Figures 17 and 18 show the bass curves with an external circuit of  $2 \times 220$  nF capacitors and a resistor of 3.3 k $\Omega$  for each channel with different values for BSYM. Figure 19 shows the bass curves with an external capacitor of 47 nF for each channel and BSYM = 0, for boost and cut.

### 7.5.6 VOLUME 2

The four volume 2 blocks are located at the end of the tone/volume control. In addition to volume control (same settings as volume 2) the balance and fader functions are also performed by individual attenuation offsets for the four attenuators. The control range of these attenuators is 56 dB in steps of 1 dB and the additional steps of -58.5 dB, -62 dB, -68 dB and a mute step.

### 7.5.7 RSA SELECTOR

The RSA selector provides the possibility to select an alternative source for the rear channels. In this event rear channels are only controlled by the volume 2 function.

### 7.5.8 CHIME ADDER

The chime adder circuit enables the chime input signal to be summed with the left front and/or right front audio, or be turned off.

# Up-level Car radio Analog Signal Processor (CASP)

TEA6886HL

## 8 LIMITING VALUES

In accordance with the Absolute Maximum Rating System (IEC 60134).

SYMBOL	PARAMETER	CONDITIONS	MIN.	MAX.	UNIT
$V_{CC}$	supply voltage		-0.3	+10	V
$V_i$	voltage at all pins (except SCL and SDA)	$V_{CC} \leq 10$ V	$V_{SS} - 0.3$	$V_{CC}$	V
	voltage at pins SCL and SDA		$V_{SS} - 0.3$	9.7	V
$P_{tot}$	total power dissipation		-	480	mW
$T_{stg}$	storage temperature		-65	+150	°C
$T_{amb}$	ambient temperature		-40	+85	°C
$V_{es}$	electrostatic handling voltage for all pins	note 1	-200	+200	V
		note 2	-2000	+2000	V

### Notes

1. Machine model ( $R = 0 \Omega$ ,  $C = 200$  pF).
2. Human body model ( $R = 1.5$  k $\Omega$ ,  $C = 100$  pF).

## 9 THERMAL CHARACTERISTICS

SYMBOL	PARAMETER	CONDITIONS	VALUE	UNIT
$R_{th(j-a)}$	thermal resistance from junction to ambient	in free air	54	K/W

## Up-level Car radio Analog Signal Processor (CASP)

TEA6886HL

### 10 CHARACTERISTICS

FM part: input signal  $V_{i(\text{MPX})(\text{p-p})} = 1.89 \text{ V}$ ;  $m = 100\%$  ( $\Delta f = \pm 75 \text{ kHz}$ ,  $f_{\text{mod}} = 400 \text{ Hz}$ ); de-emphasis of  $75 \mu\text{s}$  and series resistor at input  $R_{\text{IN}} = 182 \text{ k}\Omega$ ; FM audio measurements are taken at pins LOPO and ROPO.

Tone part:  $R_{\text{S}} = 600 \Omega$ ;  $R_{\text{L}} = 10 \text{ k}\Omega$ , AC-coupled;  $C_{\text{L}} = 2.5 \text{ nF}$ ; CLK = square wave (5 to 0 V) at 100 kHz; stereo source = A channel input; volume 1 attenuator = 0 dB; loudness = 0 dB, off; volume 2 attenuators = 0 dB; bass linear; treble linear; input voltage = 1 V,  $f = 1 \text{ kHz}$ . Tone part audio measurements are taken at pins RF and LF.  $V_{\text{CC}} = 8.3 \text{ to } 8.7 \text{ V}$ ;  $V_{\text{SS}} = 0 \text{ V}$ ;  $T_{\text{amb}} = 25 \text{ }^\circ\text{C}$ ; unless otherwise specified.

This IC shall not radiate noise in the audio system such that it disturbs any other circuit. This IC shall also not be susceptible to the radiation of any other circuit.

SYMBOL	PARAMETER	CONDITIONS	MIN.	TYP.	MAX.	UNIT
$V_{\text{CC}}$	supply voltage		7.8	8.5	9.2	V
$I_{\text{CC}}$	supply current	$V_{\text{CC}} = 8.5 \text{ V}$	32	40	48	mA
$V_{\text{HS}}$	half supply voltage	$V_{\text{CC}} = 8.5 \text{ V}$	3.75	4.25	4.75	V
$I_{\text{IREF}}$	reference current	$V_{\text{CC}} = 8.5 \text{ V}$ ; $R_{\text{IREF}} = 100 \text{ k}\Omega$	35	37	39	$\mu\text{A}$
<b>FM signal path</b>						
$V_{i(\text{MPX})(\text{p-p})}$	MPX input signal (peak-to-peak value)	$R_{\text{i}} = 182 \text{ k}\Omega$	–	1.89	–	V
$\Delta V_{i(\text{MPX})}$	overdrive margin of MPX input signal	THD = 1%	6	–	–	dB
$I_{\text{i}}$	AF input current		–	3.66	–	$\mu\text{A}$
$I_{\text{i(max)}}$	maximum AF input current	THD = 1%	7.32	–	–	$\mu\text{A}$
$V_{\text{o(rms)}}$	AF mono output signal (RMS value)	91% modulation without pilot	890	1000	1110	mV
$\Delta V_{\text{out}}$	AF mono channel balance	without pilot; $V_{\text{LOPO}}/V_{\text{ROPO}}$	–1	–	+1	dB
$\alpha_{\text{cs}}$	channel separation	aligned setting of data byte 1, bit 0 to bit 3; $m = 30\%$ modulation plus 9% pilot				
		$L = 1$ ; $R = 0$	40	47	70	dB
		$L = 0$ ; $R = 1$	40	47	70	dB
THD	total harmonic distortion	$V_{i(\text{MPX})(\text{p-p})} = 1.89 \text{ V}$ ; $f_{\text{mod}} = 1 \text{ kHz}$ without pilot	–	0.1	0.3	%
		$V_{i(\text{MPX})(\text{p-p})} = 1.89 \text{ V}$ ; $f_{\text{mod}} = 5 \text{ kHz}$	–	0.1	0.3	%
		$L = 1$ ; $R = 0$	–	0.1	0.3	%
		$L = 0$ ; $R = 1$	–	0.1	0.3	%
S/N	signal-to-noise ratio	$f = 20 \text{ Hz to } 15 \text{ kHz}$	75	78	–	dB
$\alpha_{19}$	pilot signal suppression	$f = 19 \text{ kHz}$	40	50	–	dB
$\alpha_{38}$	subcarrier suppression	$f = 38 \text{ kHz}$	35	50	–	dB
$\alpha_{57}$		$f = 57 \text{ kHz}$	40	–	–	dB
$\alpha_{76}$		$f = 76 \text{ kHz}$	50	60	–	dB

## Up-level Car radio Analog Signal Processor (CASP)

TEA6886HL

SYMBOL	PARAMETER	CONDITIONS	MIN.	TYP.	MAX.	UNIT
IM2	second order intermodulation for $f_{spur} = 1$ kHz	$f_{mod} = 10$ kHz; note 1	–	60	–	dB
IM3	third order intermodulation for $f_{spur} = 1$ kHz	$f_{mod} = 13$ kHz; note 1	–	58	–	dB
$\alpha_{57(RDS)}$	traffic radio (RDS)	$f = 57$ kHz; note 2	–	70	–	dB
$\alpha_{67}$	Subsidiary Communication Authorization (SCA)	$f = 67$ kHz; note 3	70	–	–	dB
$\alpha_{114}$	Adjacent Channel Interference (ACI)	$f = 114$ kHz; note 4	–	80	–	dB
$\alpha_{190}$		$f = 190$ kHz; note 4	–	70	–	dB
PSRR	power supply ripple rejection	$f = 100$ Hz; $V_{ripple(rms)} = 100$ mV	–	30	–	dB
$R_{SDEEML}$ ; $R_{SDEEMR}$	de-emphasis output source resistance	data byte 3, bit 5 = 1; 75 $\mu$ s	20	22.7	25.4	k $\Omega$
		data byte 3, bit 5 = 0; 50 $\mu$ s	13.4	15.2	17	k $\Omega$
$I_{FMLBUF}$ ; $I_{FMRBUF}$	current capacity of FM buffer	$V_{FMLBUF,FMRBUF} = 5.5 \pm 1$ V	50	–	200	$\mu$ A
<b>PLL VCO</b>						
$f_{osc}$	oscillator frequency		–	228	–	kHz
	frequency range of free running oscillator		190	–	270	kHz
$f_{ref}$	reference frequency at pin FREF		–	75.4	–	kHz
$V_{i(FREF)}$	reference frequency input voltage		30	100	500	mV
$Z_{i(FREF)}$	input impedance		100	–	–	k $\Omega$
<b>PLL pilot detector</b>						
$V_{i(pilot)(rms)}$	pilot threshold voltage for automatic switching by pilot input voltage (RMS value)	stereo on; STIN = 1	–	27	37	mV
		stereo off; STIN = 0	9	22	–	mV
$h_{ys(pilot)}$	hysteresis of pilot threshold voltage		–	2	–	dB
$V_{PILOT}$	switching voltage for external mono control (PILOT)		0.3	–	0.7	V
<b>AM signal path</b>						
$V_{LOPO}$ ; $V_{ROPO}$	AC output voltage at pins LOPO and ROPO	AMON = 1 and AMST = 0; $R_i = 220$ k $\Omega$ ; $V_{iAM(mono)} = 250$ mV	195	245	295	mV
$G_v$	AM stereo audio buffer voltage gain	subaddress 0H: AMON = 1 and AMST = 1; input signal at pins DEEML or DEEMR; coupled with 220 nF; $V_{i(DEEML,DEEMR)} = 200$ mV; $f_i = 1$ kHz; note 5	7	8	9	dB
$R_{i(DEEML)}$ ; $R_{i(DEEMR)}$	input resistance for AM stereo left and right	AMON = 1 and AMST = 1; note 6	80	100	120	k $\Omega$

## Up-level Car radio Analog Signal Processor (CASP)

### TEA6886HL

SYMBOL	PARAMETER	CONDITIONS	MIN.	TYP.	MAX.	UNIT
<b>Noise blanker</b>						
FM PART						
$t_{sup}$	interference suppression time		20	30	40	$\mu$ s
$I_{offset}$	gate input offset current at pins during suppression pulse duration	during AF suppression time	–	20	50	nA
$I_{ch(FMNCAP)}$	charge current (into 4 V)	no input signal; $V_{FMNCAP} = V_{FMNCAP(int)} - 0.7$ V	–16	–12.5	–9.5	$\mu$ A
$I_{dch(FMNCAP)}$	discharge current (from 5.5 V)	no input signal; $V_{FMNCAP} = V_{FMNCAP(int)} + 0.7$ V	45	70	100	$\mu$ A
<i>Trigger Threshold Control (TTC), dependency on MPX signal at MPXRDS input</i>						
$V_{FMNCAP}$	trigger threshold variation voltage	$V_{i(MPXRDS)} = 0$ V	4.5	5	5.5	V
$\Delta V_{FMNCAP}$	trigger threshold voltage	$V_{i(MPXRDS)} = 10$ mV; $f = 120$ kHz	15	40	80	mV
		$V_{i(MPXRDS)} = 100$ mV; $f = 120$ kHz	75	100	200	mV
$\Delta V_{TBL}$	trigger threshold variation with audio frequency $f = 15$ kHz	$V_{i(MPXRDS)} = 670$ mV	–	500	–	mV
<i>Trigger Threshold Control (TTC), dependency on level detector input signal</i>						
$V_{FMNCAP}$	trigger threshold voltage	$V_{LEVEL(AC)} = 0$ V	4.5	5	5.5	V
$\Delta V_{FMNCAP}$	trigger threshold voltage as a function of $V_{LEVEL(AC)}$	$V_{LEVEL(AC)} = 10$ mV; $f = 120$ kHz	–	0	–	mV
		$V_{LEVEL(AC)} = 200$ mV; $f = 120$ kHz	–	40	–	mV
<i>Trigger sensitivity measurement with pulse (on MPX signal) at MPXRDS input</i>						
$V_{pulse}$	trigger sensitivity	$t_{pulse} = 10$ $\mu$ s; write mode; data byte 3, bits 6 and 7: NBS1 = 0; NBS0 = 0	–	60	–	mV
		NBS1 = 0; NBS0 = 1	–	100	–	mV
		NBS1 = 1; NBS0 = 0	–	150	–	mV
		NBS1 = 1; NBS0 = 1	–	200	–	mV
<i>Trigger sensitivity measurement with pulse (on level signal) at AM/FM level input</i>						
$V_{pulse}$	trigger sensitivity	$t_{pulse} = 10$ $\mu$ s; $V_{LEVEL} = 0.5$ V; write mode; data byte 3, bits 6 and 7: NBS1 = 0; NBS0 = 0	–	250	–	mV
		NBS1 = 0; NBS0 = 1	–	275	–	mV
		NBS1 = 1; NBS0 = 0	–	300	–	mV
		NBS1 = 1; NBS0 = 1	–	320	–	mV



## Up-level Car radio Analog Signal Processor (CASP)

TEA6886HL

SYMBOL	PARAMETER	CONDITIONS	MIN.	TYP.	MAX.	UNIT
<b>AM PART</b>						
$m_{\text{mod}}$	trigger threshold		–	140	–	%
$V_{\text{AMPCAP(AC)}}$	AF voltage at AMHCAP	$V_{\text{iAM(mono)}} = 50 \text{ mV (RMS)}$ ; $f = 1 \text{ kHz}$	16	22	30	mV
$\alpha_{\text{AMGATE}}$	attenuation of blanking gate	$V_{\text{iAM(mono)}} = 50 \text{ mV (RMS)}$ ; gate open: internal voltage; gate closed: $V_{\text{AMHOLD(DC)}} = 4 \text{ V}$ ; note 7	–60	–70	–80	dB
$t_{\text{sup(AMHOLD)}}$	suppression time at AMHOLD	$t_{\text{pulse}} = 10 \text{ }\mu\text{s}$ ; repetition rate = 50 Hz; $V_{\text{pulse}} = 1.7 \text{ V}$ (AMNBIN); $V_{\text{LEVEL}} = 0.5 \text{ V}$	400	500	600	$\mu\text{s}$
$V_{\text{AMNCAP(DC)}}$	detector voltage; $V_{\text{ext(AMNBIN)DC}} - 0.7 \text{ V}$	$V_{\text{AMNBIN(AC)}} = 0 \text{ V}$ ; $V_{\text{LEVEL(DC)}} = 3.5 \text{ V}$	3	3.5	4	V
$f_{\text{AMHOLD}}$	trigger sensitivity	$t_{\text{pulse}} = 10 \text{ }\mu\text{s}$ ; repetition rate = 50 Hz; $V_{\text{pulse}} = 1.7 \text{ V}$ (AMNBIN); $V_{\text{LEVEL}} = 4 \text{ V}$	45	50	55	Hz
$I_{\text{offset}}$	gate input offset current at pins during suppression pulse duration	during AF suppression time	–50	0	+50	nA
<b>Muting average detector (TMUTE); see Fig.12</b>						
$V_{\text{i(LEVEL)}}$	input voltage on LEVEL		0.5	–	4	V
$G_{\text{v}}$	voltage gain LEVEL to TMUTE		–	0	–	dB
$\Delta V_{\text{TMUTE}}$	offset between TMUTE and LEVEL		–	1.5	–	V
$\Delta V_{\text{TMUTE/K}}$	temperature dependence at TMUTE		–	3.3	–	mV/K
<b>MUTING AVERAGE DETECTOR TIME CONSTANT</b>						
$I_{\text{ch(TMUTE)}}$	TMUTE charge current		–	–0.2	–	$\mu\text{A}$
$I_{\text{dch(TMUTE)}}$	TMUTE discharge current		–	0.2	–	$\mu\text{A}$
$V_{\text{O}}$	DC output voltage		2	–	5	V
<b>TEST CONDITION</b>						
$I_{\text{ch(test)}}$	capacitor charge current	data byte 6, bit 7 = 1	–	–12	–	$\mu\text{A}$
$I_{\text{dch(test)}}$	capacitor discharge current	data byte 6, bit 7 = 1	–	12	–	$\mu\text{A}$

## Up-level Car radio Analog Signal Processor (CASP)

### TEA6886HL

SYMBOL	PARAMETER	CONDITIONS	MIN.	TYP.	MAX.	UNIT
<b>AM wideband average detector (TWBAM1); see Fig.6</b>						
$V_{TWBAM1}$	DC voltage at TWBAM1 with respect to AGND	$V_{LEVEL(AC)} = 400 \text{ mV}$ ; $V_{LEVEL(DC)} = 3.5 \text{ V}$ ; $f_i = 24 \text{ kHz}$ ; write mode; data byte 1, bits 4 and 5: AWS1 = 1; AWS0 = 1	–	4.10	–	V
		AWS1 = 1; AWS0 = 0	–	3.60	–	V
		AWS1 = 0; AWS0 = 1	–	3.00	–	V
		AWS1 = 0; AWS0 = 0	–	2.35	–	V
$VC_{TWBAM1}$	DC voltage coefficient	$V_{LEVEL(AC)} = 400 \text{ mV}$ ; $V_{LEVEL(DC)} = 3.5 \text{ V}$ ; $f_i = 24 \text{ kHz}$ ; write mode; note 8; data byte 1, bits 4 and 5: AWS1 = 1; AWS0 = 1	0.69	0.82	0.98	
		AWS1 = 1; AWS0 = 0	0.60	0.72	0.86	
		AWS1 = 0; AWS0 = 1	0.50	0.60	0.71	
		AWS1 = 0; AWS0 = 0	0.40	0.47	0.56	
$V_O$	DC output voltage		1.5	–	5.5	V
<b>AM WIDEBAND AVERAGE DETECTOR TIME CONSTANT</b>						
$I_{ch(TWBAM1)}$	TWBAM1 charge current		–19.5	–15	–11.5	$\mu\text{A}$
$I_{dch(TWBAM1)}$	TWBAM1 discharge current		11.5	15	19.5	$\mu\text{A}$
<b>Ultrasonic noise average detector (TUSN1); see Fig.5</b>						
$V_{TUSN1}$	DC voltage at TUSN1 with respect to AGND	$V_{MPXRDS(AC)} = 350 \text{ mV}$ ; $V_{LEVEL(DC)} = 3.5 \text{ V}$ ; $f_i = 80 \text{ kHz}$ ; write mode; data byte 1, bits 6 and 7: USS1 = 1; USS0 = 1	–	4.25	–	V
		USS1 = 1; USS0 = 0	–	4.00	–	V
		USS1 = 0; USS0 = 1	–	3.50	–	V
		USS1 = 0; USS0 = 0	–	2.60	–	V
$VC_{TUSN1}$	DC voltage coefficient	$V_{MPXRDS(AC)} = 350 \text{ mV}$ ; $V_{LEVEL(DC)} = 3.5 \text{ V}$ ; $f_i = 80 \text{ kHz}$ ; write mode; note 9; data byte 1, bits 6 and 7: USS1 = 1; USS0 = 1	0.71	0.85	1.00	
		USS1 = 1; USS0 = 0	0.67	0.80	0.95	
		USS1 = 0; USS0 = 1	0.60	0.70	0.85	
		USS1 = 0; USS0 = 0	0.44	0.52	0.62	
$V_O$	DC output voltage		1.5	–	5.5	V

## Up-level Car radio Analog Signal Processor (CASP)

TEA6886HL

SYMBOL	PARAMETER	CONDITIONS	MIN.	TYP.	MAX.	UNIT
ULTRASONIC NOISE AVERAGE DETECTOR TIME CONSTANT						
$I_{ch}(TUSN1)$	TUSN1 charge current		-19.5	-15	-11.5	$\mu\text{A}$
$I_{dch}(TUSN1)$	TUSN1 discharge current		11.5	15	19.5	$\mu\text{A}$
<b>Peak detector for stereo noise control (TSNC)</b>						
DEPENDENCY ON LEVEL VOLTAGE; see Fig.12						
$V_{LEVEL}$	input voltage		0.5	-	4.75	V
G	gain LEVEL to TSNC		-	0	-	dB
$V_{TSNC}$	DC voltage at TSNC referred to DC level voltage at LEVEL	without MPXRDS and LEVEL (AC) input $V_{LEVEL(DC)} = 0.5 \text{ V}$ $V_{LEVEL(DC)} = 3.5 \text{ V}$	1.75 4.50	2.00 5.00	2.25 5.50	V V
$\Delta V_{TSNC/K}$	temperature dependence at TSNC		-	3.3	-	mV/K
DEPENDENCY ON ULTRASONIC NOISE; see Fig.5						
$V_{TSNC}$	DC voltage at TSNC with respect to AGND	$V_{MPXRDS(AC)} = 350 \text{ mV}$ ; $V_{LEVEL(DC)} = 3.5 \text{ V}$ ; $f_i = 80 \text{ kHz}$ ; write mode; data byte 1, bits 6 and 7: USS1 = 1; USS0 = 1 USS1 = 1; USS0 = 0 USS1 = 0; USS0 = 1 USS1 = 0; USS0 = 0	- - - -	4.25 4.00 3.50 2.60	- - - -	V V V V
$V_{C_{TSNC}}$	DC voltage coefficient	$V_{MPXRDS(AC)} = 350 \text{ mV}$ ; $V_{LEVEL(DC)} = 3.5 \text{ V}$ ; $f_i = 80 \text{ kHz}$ ; write mode; note 10; data byte 1, bits 6 and 7: USS1 = 1; USS0 = 1 USS1 = 1; USS0 = 0 USS1 = 0; USS0 = 1 USS1 = 0; USS0 = 0	0.71 0.67 0.60 0.44	0.85 0.80 0.70 0.52	1.00 0.95 0.85 0.62	
$V_O$	DC output voltage		2	-	5	V

## Up-level Car radio Analog Signal Processor (CASP)

TEA6886HL

SYMBOL	PARAMETER	CONDITIONS	MIN.	TYP.	MAX.	UNIT
DEPENDENCY ON AM WIDEBAND NOISE; see Fig.6						
V <sub>TSNC</sub>	DC voltage at TSNC	V <sub>LEVEL(AC)</sub> = 400 mV; V <sub>LEVEL(DC)</sub> = 3.5 V; f <sub>i</sub> = 24 kHz; write mode; data byte 1, bits 4 and 5: AWS1 = 1; AWS0 = 1	–	4.10	–	V
		AWS1 = 1; AWS0 = 0	–	3.60	–	V
		AWS1 = 0; AWS0 = 1	–	3.00	–	V
		AWS1 = 0; AWS0 = 0	–	2.35	–	V
V <sub>C<sub>TSNC</sub></sub>	DC voltage coefficient	V <sub>LEVEL(AC)</sub> = 400 mV; V <sub>LEVEL(DC)</sub> = 3.5 V; f <sub>i</sub> = 24 kHz; write mode; note 11; data byte 1, bits 4 and 5: AWS1 = 1; AWS0 = 1	0.69	0.82	0.98	
		AWS1 = 1; AWS0 = 0	0.60	0.72	0.86	
		AWS1 = 0; AWS0 = 1	0.50	0.60	0.71	
		AWS1 = 0; AWS0 = 0	0.40	0.47	0.56	
V <sub>O</sub>	DC output voltage		1.5	–	5.5	V
DETECTOR TIME CONSTANT						
I <sub>ch(TSNC)</sub>	TSNC charge current		–	–2.5	–	μA
I <sub>dch(TSNC)</sub>	TSNC discharge current		–	65	–	μA
TEST CONDITION						
I <sub>ch(test)</sub>	charge current for testing	data byte 6, bit 7 = 1; V <sub>LEVEL(DC)</sub> = 2 V; V <sub>TSNC(DC)</sub> = 2.8 V	–	–1.5	–	mA
I <sub>dch(test)</sub>	discharge current for testing	data byte 6, bit 7 = 1; V <sub>LEVEL(DC)</sub> = 2 V; V <sub>TSNC(DC)</sub> = 4.2 V	–	200	–	μA

## Up-level Car radio Analog Signal Processor (CASP)

### TEA6886HL

SYMBOL	PARAMETER	CONDITIONS	MIN.	TYP.	MAX.	UNIT
<b>Ultrasonic noise peak detector (TUSN2); see Fig.5</b>						
V <sub>TUSN2</sub>	DC voltage at TUSN2 with respect to AGND	V <sub>MPXRDS(AC)</sub> = 350 mV; V <sub>LEVEL(DC)</sub> = 3.5 V; f <sub>i</sub> = 80 kHz; write mode; data byte 1, bits 6 and 7: USS1 = 1; USS0 = 1	–	4.25	–	V
		USS1 = 1; USS0 = 0	–	4.00	–	V
		USS1 = 0; USS0 = 1	–	3.50	–	V
		USS1 = 0; USS0 = 0	–	2.60	–	V
V <sub>CTUSN2</sub>	DC voltage coefficient	V <sub>MPXRDS(AC)</sub> = 350 mV; V <sub>LEVEL(DC)</sub> = 3.5 V; f <sub>i</sub> = 80 kHz; write mode; note 12; data byte 1, bits 6 and 7: USS1 = 1; USS0 = 1	0.71	0.85	1.00	
		USS1 = 1; USS0 = 0	0.67	0.80	0.95	
		USS1 = 0; USS0 = 1	0.60	0.70	0.85	
		USS1 = 0; USS0 = 0	0.44	0.52	0.62	
V <sub>O</sub>	DC output voltage		1.5	–	5.5	V
<b>DETECTOR TIME CONSTANT</b>						
I <sub>ch(TUSN2)</sub>	TUSN2 charge current		–	–1.6	–	μA
I <sub>dch(TUSN2)</sub>	TUSN2 discharge current		–	21	–	μA
<b>AM wideband peak detector (TWBAM2); see Fig.6</b>						
V <sub>TWBAM2</sub>	DC voltage at TWBAM2 with respect to AGND	V <sub>LEVEL(AC)</sub> = 400 mV; V <sub>LEVEL(DC)</sub> = 3.5 V; f <sub>i</sub> = 24 kHz; write mode; data byte 1, bits 4 and 5: AWS1 = 1; AWS0 = 1	–	4.10	–	V
		AWS1 = 1; AWS0 = 0	–	3.60	–	V
		AWS1 = 0; AWS0 = 1	–	3.00	–	V
		AWS1 = 0; AWS0 = 0	–	2.35	–	V
V <sub>CTWBAM2</sub>	DC voltage coefficient	V <sub>LEVEL(AC)</sub> = 400 mV; V <sub>LEVEL(DC)</sub> = 3.5 V; f <sub>i</sub> = 24 kHz; write mode; note 13; data byte 1, bits 4 and 5: AWS1 = 1; AWS0 = 1	0.69	0.82	0.98	
		AWS1 = 1; AWS0 = 0	0.60	0.72	0.86	
		AWS1 = 0; AWS0 = 1	0.50	0.60	0.71	
		AWS1 = 0; AWS0 = 0	0.40	0.47	0.56	
V <sub>O</sub>	DC output voltage		2	–	5	V

## Up-level Car radio Analog Signal Processor (CASP)

TEA6886HL

SYMBOL	PARAMETER	CONDITIONS	MIN.	TYP.	MAX.	UNIT
DETECTOR TIME CONSTANT						
$I_{ch(TWBAM2)}$	TWBAM2 charge current		–	–1.6	–	$\mu\text{A}$
$I_{dch(TWBAM2)}$	TWBAM2 discharge current		–	21	–	$\mu\text{A}$
<b>Soft mute;</b> see Figs 7 and 4						
$\alpha_{0dB}$	attenuation at LOPO and ROPO	$V_{TMUTE} = 3.5\text{ V}; V_{TUSN1} = 3.5\text{ V}$	–0.5	0	+0.5	dB
$\alpha_{6dB}$	start of muting; AC attenuation at LOPO and ROPO	see Fig.4; write mode; MSL0 = 1; MSL1 = 1				
		MST1 = 0; MST0 = 0; $V_{TMUTE} = 0.42V_{TUSN1}$ without AC	3	6	9	dB
		MST1 = 0; MST0 = 1; $V_{TMUTE} = 0.45V_{TUSN1}$ without AC	3	6	9	dB
		MST1 = 1; MST0 = 0; $V_{TMUTE} = 0.47V_{TUSN1}$ without AC	3	6	9	dB
		MST1 = 1; MST0 = 1; $V_{TMUTE} = 0.49V_{TUSN1}$ without AC	3	6	9	dB
$\alpha_{10dB}$	AC attenuation for setting of mute slope at LOPO and ROPO	MST1 = 0; MST0 = 0; see Fig.7				
		MSL1 = 0; MSL0 = 0; $V_{TMUTE(DC)} = 0.35V_{TUSN1}$ without AC	7	10	13	dB
		MSL1 = 0; MSL0 = 1; $V_{TMUTE(DC)} = 0.38V_{TUSN1}$ without AC	7	10	13	dB
		MSL1 = 1; MSL0 = 0; $V_{TMUTE(DC)} = 0.39V_{TUSN1}$ without AC	7	10	13	dB
		MSL1 = 1; MSL0 = 1; $V_{TMUTE(DC)} = 0.395V_{TUSN1}$ without AC	7	10	13	dB

## Up-level Car radio Analog Signal Processor (CASP)

TEA6886HL

SYMBOL	PARAMETER	CONDITIONS	MIN.	TYP.	MAX.	UNIT
<b>Stereo Noise Control (SNC)</b>						
$\alpha_{cs(start)}$	start of channel separation	aligned at L = 1 and R = 0; data byte 2, SST[3:0] = 1111; $V_{TSNC}$ or $V_{TUSN1}$ or $V_{TWBAM1} = 0.63V_{TUSN1}$ without AC; see note 14 and Fig.9	4.5	6	7.5	dB
		aligned at L = 1 and R = 0; data byte 2, SST[3:0] = 1000; $V_{TSNC}$ or $V_{TUSN1}$ or $V_{TWBAM1} = 0.70V_{TUSN1}$ without AC; see note 14 and Fig.9	4.5	6	7.5	dB
		aligned at L = 1 and R = 0; data byte 2, SST[3:0] = 0000; $V_{TSNC}$ or $V_{TUSN1}$ or $V_{TWBAM1} = 0.74V_{TUSN1}$ without AC; see note 14 and Fig.9	4.5	6	7.5	dB
$\alpha_{cs(slope)}$	slope of channel separation	aligned at L = 1 and R = 0; data byte 2, SST[3:0] = 1000; $V_{TSNC} = 0.72V_{TUSN1}$ without AC; see note 15 and Fig.8; data byte 2, bits 4 and 5:				
		SSL1 = 0; SSL0 = 0	3	5	7	dB
		SSL1 = 0; SSL0 = 1	5	7	9	dB
		SSL1 = 1; SSL0 = 0	11	13	15	dB
		SSL1 = 1; SSL0 = 1 (not defined)				

## Up-level Car radio Analog Signal Processor (CASP)

TEA6886HL

SYMBOL	PARAMETER	CONDITIONS	MIN.	TYP.	MAX.	UNIT
<b>High Cut Control (HCC)</b>						
$\alpha_{\text{HCC(start)}}$	AC attenuation for start of HCC	AF = 10 kHz; $V_{\text{MPXIN}} = 200$ mV; HSL1 = 1; HSL0 = 0; data byte 0, SMUT = 0 and MONO = 1; write mode; see note 16 and Fig.10; data byte 3, bits 2 and 3: HST1 = 1; HST0 = 1; $V_{\text{LEVEL(DC)}} = 1.00$ V HST1 = 1; HST0 = 0; $V_{\text{LEVEL(DC)}} = 1.25$ V HST1 = 0; HST0 = 1; $V_{\text{LEVEL(DC)}} = 1.50$ V HST1 = 0; HST0 = 0; $V_{\text{LEVEL(DC)}} = 1.75$ V	1.5	3	4.5	dB
			1.5	3	4.5	dB
			1.5	3	4.5	dB
			1.5	3	4.5	dB
$\alpha_{\text{HCC(slope)}}$	AC attenuation for slope of HCC	AF = 10 kHz; $V_{\text{MPXIN}} = 200$ mV; $C_{\text{FMLBUF}}, C_{\text{FMRBUF}} = 2.7$ nF; HST1 = 1; HST0 = 1; data byte 0, SMUT = 0 and MONO = 1; see note 16 and Fig.11; data byte 3, bits 0 and 1: HSL1 = 1; HSL0 = 1 HSL1 = 1; HSL0 = 0 HSL1 = 0; HSL0 = 1 HSL1 = 0; HSL0 = 0	5.5	7.5	9.5	dB
			4	6	8	dB
			2	4	6	dB
			1	3	5	dB
$\alpha_{\text{HCC(max)}}$	maximum HCC attenuation	AF = 10 kHz; $V_{\text{TMUTE}} = 2$ V; data byte 0, SMUT = 0 and MONO = 1; data byte 3, bit 1 = bit 0 = 1 $C_{\text{FMLBUF}}, C_{\text{FMRBUF}} = 2.7$ nF; data byte 3, bit 4 = 1 $C_{\text{FMLBUF}}, C_{\text{FMRBUF}} = 680$ pF; data byte 3, bit 4 = 0	8	10	14.5	dB
			8	10	14.5	dB



## Up-level Car radio Analog Signal Processor (CASP)

### TEA6886HL

SYMBOL	PARAMETER	CONDITIONS	MIN.	TYP.	MAX.	UNIT
<b>Analog-to-digital converters</b>						
LEVEL ANALOG-TO-DIGITAL CONVERTER (6-BIT)						
$V_{LEVEL(min)}$	lower limit of conversion range		–	740	–	mV
$V_{LEVEL(max)}$	upper limit of conversion range		–	3.4	–	V
$\Delta V_{LEVEL}$	bit resolution		–	42.5	–	mV
ULTRASONIC NOISE ANALOG-TO-DIGITAL CONVERTER (3-BIT)						
$V_{TUSN(min)}$	lower limit of conversion range		–	2.1	–	V
$V_{TUSN(max)}$	upper limit of conversion range		–	4	–	V
$\Delta V_{TUSN}$	bit resolution		–	320	–	mV
AM WIDEBAND NOISE ANALOG-TO-DIGITAL CONVERTER (3-BIT)						
$V_{TWBAM(min)}$	lower limit of conversion range		–	2.1	–	V
$V_{TWBAM(max)}$	upper limit of conversion range		–	4	–	V
$\Delta V_{TWBAM}$	bit resolution		–	320	–	mV
<b>Tone/volume control</b>						
$G_{v(max)}$	maximum voltage gain	$R_S \leq 10 \Omega$ ; $R_L \geq 10 M\Omega$	19	20	21	dB
$G_{v(signal)}$	signal voltage gain	$T_{amb} = 25 \text{ }^\circ\text{C}$	–0.75	0	+0.75	dB
		$T_{amb} = -40 \text{ to } +85 \text{ }^\circ\text{C}$	–1	0	+1	dB
$V_{o(rms)}$	output voltage level	THD $\leq 0.5\%$	–	2000	–	mV
		THD = 1%; $G_v = 3 \text{ dB}$	2300	–	–	mV
		$R_L = 2 \text{ k}\Omega$ ; $C_L = 10 \text{ nF}$ ; THD = 1%	2000	–	–	mV
$V_{i(rms)}$	input sensitivity	$V_o = 500 \text{ mV}$ ; $G_v = 20 \text{ dB}$	–	50	–	mV
$f_{ro}$	roll-off frequency	high frequency (–1 dB)	20000	–	–	Hz
		input A; $C_{KIL} = C_{KIR} = 100 \text{ nF}$ ; $C_{KVL} = C_{KVR} = 220 \text{ nF}$				
		low frequency (–1 dB)	–	35	45	Hz
		low frequency (–3 dB)	–	20	25	Hz
		input C; $C_{KICL} = C_{KICR} = 1 \text{ }\mu\text{F}$ ; $C_{KVL} = C_{KVR} = 220 \text{ nF}$				
low frequency (–1 dB)	–	18	23	Hz		
low frequency (–3 dB)	–	10	13	Hz		
$\alpha_{cs}$	channel separation	$V_i = 1 \text{ V}$ ; frequency range 250 Hz to 20 kHz	74	80	–	dB

## Up-level Car radio Analog Signal Processor (CASP)

TEA6886HL

SYMBOL	PARAMETER	CONDITIONS	MIN.	TYP.	MAX.	UNIT
THD	total harmonic distortion	valid for input channel A, B or C; same for all 4 outputs refer to inputs				
		$V_{i(rms)} = 1\text{ V}$ ; $f = 1\text{ kHz}$ ; volume 1 attenuator: $-6\text{ dB}$ ; equalizer bands flat	–	0.05	0.1	%
		$V_{i(rms)} = 2\text{ V}$ ; $f = 1\text{ kHz}$ ; $V_{CC} = 8.3\text{ V}$ ; volume 1 attenuator: $-13\text{ dB}$ ; equalizer bands flat	–	0.1	0.3	%
		$V_{i(rms)} = 2\text{ V}$ ; $f = 1\text{ kHz}$ ; $V_{CC} = 8.5\text{ V}$ ; volume 1 attenuator: $0\text{ dB}$ ; equalizer bands flat	–	0.05	0.1	%
		$V_{i(rms)} = 1\text{ V}$ ; $f = 1\text{ kHz}$ ; $V_{CC} = 8.3\text{ V}$ ; volume 1 attenuator: $0\text{ dB}$ ; equalizer bands flat	–	0.01	0.1	%
		$V_{i(rms)} = 2.3\text{ V}$ ; $f = 1\text{ kHz}$ ; $V_{CC} = 9\text{ V}$ ; volume 1 attenuator: $-13\text{ dB}$ ; equalizer bands flat	–	0.13	0.3	%
		$V_{i(rms)} = 1\text{ V}$ ; $f = 20\text{ Hz to }20\text{ kHz}$ ; volume 1 attenuator: $-6\text{ dB}$ ; equalizer bands flat	–	0.05	0.2	%
		$V_{i(rms)} = 2\text{ V}$ ; $f = 20\text{ Hz to }20\text{ kHz}$ ; $V_{CC} = 8.3\text{ V}$ ; volume 1 attenuator: $-13\text{ dB}$ ; equalizer bands flat	–	0.1	0.3	%
		$V_{i(rms)} = 2.3\text{ V}$ ; $f = 20\text{ Hz to }20\text{ kHz}$ ; $V_{CC} = 9\text{ V}$ ; volume 1 attenuator: $-13\text{ dB}$ ; equalizer bands flat	–	0.1	0.3	%
		$V_{i(rms)} = 0.5\text{ V}$ ; $f = 25\text{ Hz}$ ; volume 1 attenuator: $0\text{ dB}$ ; equalizer bass boost: $+8\text{ dB}$	–	0.1	0.2	%
$V_{i(rms)} = 0.5\text{ V}$ ; $f = 4\text{ kHz}$ ; volume 1 attenuator: $0\text{ dB}$ ; equalizer treble boost: $+8\text{ dB}$	–	0.15	0.3	%		
	chime adder total harmonic distortion	$V_{i(rms)} = 0.5\text{ V}$ ; $f = 1\text{ kHz}$ ; $V_{CC} = 8.5\text{ V}$ ; no input signal at input A	–	0.04	0.1	%
PSRR	power supply ripple rejection $C_{VHS} = 47\text{ }\mu\text{F}$ ; $C_{SCAP} = 22\text{ }\mu\text{F}$	stereo source: A, B, C or mono; $V_{CC} = 8.5\text{ V} + 0.2\text{ V (RMS)}$				
		$f = 20\text{ to }100\text{ Hz}$	35	46	–	dB
		$f = 1\text{ to }20\text{ kHz}$	50	65	–	dB
		$f = 1\text{ kHz}$	50	75	–	dB

## Up-level Car radio Analog Signal Processor (CASP)

TEA6886HL

SYMBOL	PARAMETER	CONDITIONS	MIN.	TYP.	MAX.	UNIT
$V_{\text{noise(rms)}}$	noise voltage CCIR-ARM weighted (RMS value) without input signal and shorted AF inputs	volume 1 attenuator: +20 dB	–	65	100	$\mu\text{V}$
		volume 1 attenuator: +20 dB; symmetrical input	–	100	140	$\mu\text{V}$
		volume 1 attenuator: 0 dB	–	10	14	$\mu\text{V}$
		volume 1 attenuator: 0 dB; symmetrical input	–	12.5	18	$\mu\text{V}$
		volume 1 attenuator: 0 dB; bass and treble boost: 6 dB	–	16	25	$\mu\text{V}$
		volume 1 attenuator: 0 dB; bass and treble boost: 6 dB; symmetrical input	–	22	32	$\mu\text{V}$
		volume 1 attenuator: –9 dB	–	9	14	$\mu\text{V}$
		minimum volume; volume 1 attenuator: –18 dB; loudness: –20 dB; volume 2 attenuator: –22 dB	–	5	8	$\mu\text{V}$
		mute selected: data byte 8, AMUT = 1	–	3.5	5	$\mu\text{V}$
		volume setting: –20 dB; volume 1 attenuator: –10 dB; loudness: –10 dB; A-weighted	–	5.7	8	$\mu\text{V}$
CMRR	input common mode rejection	C channel input; $V_{i(\text{rms})} = 1 \text{ V}$ ; $f = 20 \text{ Hz to } 20 \text{ kHz}$ on CLIP, CRIP and CCOM	48	53	–	dB
		C channel input; $V_{i(\text{rms})} = 1 \text{ V}$ ; $f = 1 \text{ kHz}$ on CLIP, CRIP and CCOM	48	53	–	dB
		C channel input; $V_{i(\text{rms})} = 1 \text{ V}$ ; $f = 20 \text{ Hz to } 20 \text{ kHz}$ on CLIP, CRIP and CCOM; volume attenuator: –15 dB	63	68	–	dB
$\text{CMRR}_{\text{mono}}$	mono input common mode rejection	source = mono input	40	45	–	dB
$\alpha_{\text{ct}}$	crosstalk between bus inputs and signal outputs	clock frequency = 50 kHz; repetition burst rate = 300 Hz; total initialization; note 17	–	110	–	dB
$t_{\text{ABC}}$	Audio Blend Control (ABC) step time	$C_{\text{ASICAP}} = 22 \text{ nF}$ ; write mode; data byte 4, bits 6 and 7:				
		ASI1 = 0; ASI0 = 0	–	0.83	–	ms
		ASI1 = 0; ASI0 = 1	–	3.33	–	ms
		ASI1 = 1; ASI0 = 0	–	8.33	–	ms
		ASI1 = 1; ASI0 = 1	–	20	–	ms

## Up-level Car radio Analog Signal Processor (CASP)

TEA6886HL

SYMBOL	PARAMETER	CONDITIONS	MIN.	TYP.	MAX.	UNIT
<b>Source selector</b>						
$Z_{i(\text{stereo})}$	stereo input impedance (A and B input)		80	100	120	k $\Omega$
$Z_{i(\text{sym})}$	symmetrical input impedance (C and mono input)		24	30	36	k $\Omega$
$Z_{i(\text{CHIME})}$	CHIME input impedance (chime input)		80	100	120	k $\Omega$
$Z_o$	output impedance at ROPO and LOPO		–	80	100	$\Omega$
$R_L$	output load resistance at ROPO and LOPO		10	–	–	k $\Omega$
$C_L$	output load capacitance at ROPO and LOPO		0	–	2500	pF
$G_V$	source selector voltage gain		–0.2	0	+0.2	dB
$\alpha_S$	input isolation of one selected source to any other input	$f = 1 \text{ kHz}$	90	105	–	dB
		$f = 12.5 \text{ kHz}$	80	95	–	dB
		$f = 20 \text{ Hz to } 20 \text{ kHz}$	75	90	–	dB
$V_{i(\text{rms})}$	maximum input voltage (RMS value)	THD < 0.5%; $V_{CC} = 8.5 \text{ V}$	2.0	2.15	–	V
		THD < 0.5%; $V_{CC} = 7.8 \text{ V}$	1.8	1.9	–	V
<b>Loudness control</b>						
$Z_i$	input impedance at ROPI and LOPI		80	100	120	k $\Omega$
$G_{\text{loudness}}$	loudness control, maximum gain	$f = 1 \text{ kHz}$ ; loudness on/off	–0.2	0	+0.2	dB
	loudness control, minimum gain	$f = 1 \text{ kHz}$ ; loudness on/off	–18.5	–20	–21.5	dB
$\Delta G_{\text{loudness}}$	gain, loudness on referred to loudness off	$f = 1 \text{ kHz}$ ; $G_{\text{loudness}} = -20 \text{ dB}$	–1.5	0	+1.5	dB
$G_{\text{step}}$	step resolution gain	$f = 1 \text{ kHz}$	–	1	–	dB
	step error between any adjoining step	$f = 1 \text{ kHz}$	–	–	0.5	dB
$L_{B(\text{max})}$	maximum loudness boost; without influence of coupling capacitors	compared to 1 kHz; loudness on				
		$f = 30 \text{ Hz}$	17	18.5	19	dB
		$f = 10 \text{ kHz}$	4	5	6	dB
		compared to 1 kHz; loudness off				
		$f = 30 \text{ Hz}$	–1	–	0	dB
		$f = 10 \text{ kHz}$	–1	–	0	dB
	$f_{\text{ref}} = 30 \text{ Hz}$ ; $f_{\text{meas}} = 300 \text{ Hz}$ ; bass boost only	12.5	14	15.5	dB	
	$f_{\text{ref}} = 30 \text{ Hz}$ ; $f_{\text{meas}} = 300 \text{ Hz}$ ; bass and treble boost	12	13.5	15	dB	

## Up-level Car radio Analog Signal Processor (CASP)

### TEA6886HL

SYMBOL	PARAMETER	CONDITIONS	MIN.	TYP.	MAX.	UNIT
<b>Volume 1 control</b>						
$G_v$	voltage gain		-36	-	+20	dB
$G_{\text{step}}$	step resolution gain		-	1	-	dB
	step error between any adjoining step		-	-	0.5	dB
$\Delta G_a$	attenuator gain set error	$G_v = +20$ to $-36$ dB	-1	0	+1	dB
$\Delta G_{\text{track}}$	gain tracking error	$G_v = +20$ to $-36$ dB	-	0	1	dB
<b>Treble control</b>						
$G_{\text{treble}}$	treble gain control, maximum boost	$f = 10$ kHz; $V_{i(\text{rms})} = 200$ mV	13	14	15	dB
	maximum attenuation	$f = 10$ kHz	13	14	15	dB
$G_{\text{step}}$	step resolution gain	$f = 10$ kHz	-	2	-	dB
	step error between any adjoining step	$f = 10$ kHz	-	-	0.5	dB
<b>Bass control</b>						
$G_{\text{bass}}$	bass gain control, maximum boost	external T-filter; $f = 60$ Hz; BSYB = 1; $V_{i(\text{rms})} = 200$ mV	16	18	20	dB
	maximum attenuation	external T-filter; $f = 60$ Hz; BSYC = 0	16	18	20	dB
		external T-filter; $f = 60$ Hz; BSYC = 1	13	14.4	15.5	dB
$G_{\text{step}}$	step resolution gain	$f = 60$ Hz; boost; BSYB = 1	-	2	-	dB
		$f = 60$ Hz; cut; BSYC = 0	-	2	-	dB
		$f = 60$ Hz; cut; BSYC = 1	1.2	1.6	1.9	dB
	step error between any adjoining step	$f = 60$ Hz	-	-	0.5	dB
$f_c$	centre frequency	$C_{\text{bass}} = 2 \times 220$ nF; $R_{\text{bass}} = 3.3$ k $\Omega$	50	60	70	Hz
$Q_e$	equalizer quality factor	$V_{i(\text{rms})} = 200$ mV; boost = 12 dB	0.8	0.9	1.1	
$EQ_{\text{bow}}$	equalizer bowing	$V_{i(\text{rms})} = 200$ mV; bass and treble boost = 12 dB; reference flat frequency response	-	2.1	3.3	dB
<b>Volume 2 control</b>						
$G_v$	voltage gain		-68	-	0	dB
$G_{\text{step}}$	step resolution	$G_v = 0$ to $-56$ dB	-	1	-	dB
	step error between any adjoining step	$G_v = 0$ to $-56$ dB	-	-	0.5	dB
	additional steps		-	-58.5	-	dB
			-	-62	-	dB
		-	-68	-	dB	

## Up-level Car radio Analog Signal Processor (CASP)

TEA6886HL

SYMBOL	PARAMETER	CONDITIONS	MIN.	TYP.	MAX.	UNIT
$\alpha_{\text{mute}}$	mute attenuation		100	110	–	dB
		$f = 20 \text{ Hz to } 20 \text{ kHz}$	75	85	–	dB
$\Delta G_a$	attenuator gain set error	$G_v = 0 \text{ to } -32 \text{ dB}$	–1	–	+1	dB
		$G_v = -32 \text{ to } -68 \text{ dB}$	–2	–	+2	dB
$\Delta G_{\text{track}}$	gain tracking error	$G_v = 0 \text{ to } -56 \text{ dB}$	–	0	1	dB
$Z_o$	output impedance		–	80	120	$\Omega$
$R_L$	output load resistance		2	–	–	$k\Omega$
$C_{o(L)}$	output load capacitance		0	–	10	nF
$R_{o(L)}$	DC load resistance at output to ground		4.7	–	–	$k\Omega$
<b>Chime adder</b>						
$G_{v(\text{CHIME})}$	chime adder voltage gain	$V_{i(\text{rms})} = 1 \text{ V}$ ; chime input; chime adder on	–21	–20	–19	dB
$V_{i(\text{CHIME})(\text{rms})}$	maximum chime input voltage (sine wave)	main output voltage $V_{o(\text{rms})} < 1.5 \text{ V}$ ; chime input; chime adder on	2.0	–	–	V
k	factor for $V_{i(\text{CHIME})}$ to avoid internal clipping	$k \times V_{i(\text{CHIME})(\text{p-p})} < 5.7 \text{ V} - V_{o(\text{p-p})}$	0.22	0.25	0.28	
<b>Digital part (SDA, SDAQ, SCL, SCLQ, FMHOLD, AFSAMPLE); note 18</b>						
$V_{IH}$	HIGH-level input voltage		3	5	9.7	V
$V_{IL}$	LOW-level input voltage		–0.3	+0.3	+1.5	V
$I_{IH}$	HIGH-level input current	$V_{CC} = 0 \text{ to } 9.5 \text{ V}$	–10	–	+10	$\mu\text{A}$
$I_{IL}$	LOW-level input current		–10	–	+10	$\mu\text{A}$
$V_{OL}$	LOW-level output voltage SDA	$I_L = 3 \text{ mA}$	–	–	0.4	V
<b>Digital part (SDAQ and SCLQ); note 18</b>						
$I_{o(\text{sink})}$	output sink current		–	–	600	$\mu\text{A}$
$R_{pu}$	pull-up resistance		–	–	22	$k\Omega$
$C_L$	load capacitance		–	–	20	pF
<b>Digital part (ADR); note 18</b>						
$V_{IH}$	HIGH-level input voltage		3	–	$V_{CC}$	V
$V_{IL}$	LOW-level input voltage		–0.3	–	+1.5	V
$I_{IH}$	HIGH-level input current		–	–	150	$\mu\text{A}$
$I_{IL}$	LOW-level input current		–80	–	–	$\mu\text{A}$

## Up-level Car radio Analog Signal Processor (CASP)

TEA6886HL

### Notes to the characteristics

1. Intermodulation suppression; Beat Frequency Components (BFC):

$$IM2 = \frac{V_{o(\text{signal})}(\text{at } 1 \text{ kHz})}{V_{o(\text{spurious})}(\text{at } 1 \text{ kHz})}; f_s = (2 \times 10 \text{ kHz}) - 19 \text{ kHz}$$

$$IM3 = \frac{V_{o(\text{signal})}(\text{at } 1 \text{ kHz})}{V_{o(\text{spurious})}(\text{at } 1 \text{ kHz})}; f_s = (3 \times 13 \text{ kHz}) - 38 \text{ kHz}$$

measured with 91% mono signal;  $f_{\text{mod}} = 10 \text{ kHz}$  or  $13 \text{ kHz}$ ; 9% pilot signal.

2. RDS suppression:

$$\alpha_{57(\text{RDS})} = \frac{V_{o(\text{signal})}(\text{at } 1 \text{ kHz})}{V_{o(\text{spurious})}(\text{at } 1 \text{ kHz} \pm 23 \text{ Hz})}$$

measured with 91% stereo signal;  $f_{\text{mod}} = 1 \text{ kHz}$ ; 9% pilot signal; 5% RDS subcarrier ( $f_s = 57 \text{ kHz}$ ;  $f_{\text{mod}} = 23 \text{ Hz}$ ; AM  $m = 0.6$ ).

3. Subsidiary Communication Authorization (SCA):

$$\alpha_{67} = \frac{V_{o(\text{signal})}(\text{at } 1 \text{ kHz})}{V_{o(\text{spurious})}(\text{at } 9 \text{ kHz})}; f_s = (2 \times 38 \text{ kHz}) - 67 \text{ kHz}$$

measured with 81% mono signal;  $f_{\text{mod}} = 1 \text{ kHz}$ ; 9% pilot signal; 10% SCA subcarrier ( $f_s = 67 \text{ kHz}$ , unmodulated).

4. Adjacent Channel Interference (ACI):

$$\alpha_{114} = \frac{V_{o(\text{signal})}(\text{at } 1 \text{ kHz})}{V_{o(\text{spurious})}(\text{at } 4 \text{ kHz})}; f_s = 110 \text{ kHz} - (3 \times 38 \text{ kHz})$$

$$\alpha_{190} = \frac{V_{o(\text{signal})}(\text{at } 1 \text{ kHz})}{V_{o(\text{spurious})}(\text{at } 4 \text{ kHz})}; f_s = 186 \text{ kHz} - (5 \times 38 \text{ kHz})$$

measured with 90% mono signal;  $f_{\text{mod}} = 1 \text{ kHz}$ ; 9% pilot signal; 1% spurious signal ( $f_s = 110 \text{ kHz}$  or  $186 \text{ kHz}$ , unmodulated).

5. AM stereo audio buffer gain:

$$G = 20 \log \frac{V_{\text{LOPO}}}{V_{\text{DEEML}}}; G = 20 \log \frac{V_{\text{ROPO}}}{V_{\text{DEEMR}}}$$

6. Input resistance for AM stereo left and right:

$$R_{i(\text{DEEML})} = \frac{\Delta V_{\text{DEEML}}}{\Delta I_{i(\text{DEEML})}}; R_{i(\text{DEEMR})} = \frac{\Delta V_{\text{DEEMR}}}{\Delta I_{i(\text{DEEMR})}}$$

7. Attenuation of blanking gate:

$$\alpha_{\text{AMGATE}} = 20 \log \frac{V_{\text{AMPCAP}} \text{ at gate open}}{V_{\text{AMPCAP}} \text{ at gate close}}$$

8. TWBAM1 DC voltage coefficient:

$$VC_{\text{TWBAM1}} = \frac{V_{\text{TWBAM1}} \text{ with AC voltage at LEVEL}}{V_{\text{TWBAM1}} \text{ without AC voltage}}$$

9. TUSN1 DC voltage coefficient:

$$VC_{\text{TUSN1}} = \frac{V_{\text{TUSN1}} \text{ with AC voltage at MPXRDS}}{V_{\text{TUSN1}} \text{ without AC voltage}}$$

10. TSNC DC voltage coefficient:

$$VC_{\text{TSNC}} = \frac{V_{\text{TSNC}} \text{ with AC voltage at MPXRDS}}{V_{\text{TSNC}} \text{ without AC voltage}}$$

## Up-level Car radio Analog Signal Processor (CASP)

TEA6886HL

11. TSNC DC voltage coefficient:

$$VC_{TSNC} = \frac{V_{TSNC} \text{ with AC voltage at LEVEL}}{V_{TSNC} \text{ without AC voltage}}$$

12. TUSN2 DC voltage coefficient:

$$VC_{TUSN2} = \frac{V_{TUSN2} \text{ with AC voltage at MPXRDS}}{V_{TUSN2} \text{ without AC voltage}}$$

13. TWBAM2 DC voltage coefficient:

$$VC_{TWBAM2} = \frac{V_{TWBAM2} \text{ with AC voltage at LEVEL}}{V_{TWBAM2} \text{ without AC voltage}}$$

14. Start of channel separation:

$$\alpha_{cs(start)} = \left| 20 \log \frac{V_{LOPO(AC)}}{V_{ROPO(AC)}} \right|$$

15. Slope of channel separation:

$$\alpha_{cs(slope)} = \left| 20 \log \frac{V_{LOPO(AC)}}{V_{ROPO(AC)}} \right|$$

16. AC attenuation for start and slope of HCC:

$$\alpha_{HCC(10 \text{ kHz})} = 20 \log \frac{V_{LOPO,ROPO}}{V_{LOPO,ROPO} \text{ without High Cut active}}$$

17. Crosstalk between bus inputs and signal outputs:

$$\alpha_{ct} = 20 \log \frac{V_{bus(p-p)}}{V_{o(rms)}}$$

18. The characteristics are in accordance with the I<sup>2</sup>C-bus specification, with the exception that the data hold time  $t_{HD, DAT}$  must be at least 1  $\mu$ s. This specification, "The I<sup>2</sup>C-bus and how to use it", can be ordered using the code 9398 393 40011.



# Up-level Car radio Analog Signal Processor (CASP)

TEA6886HL

## 11 I<sup>2</sup>C-BUS PROTOCOL

**Table 1** Write mode

S <sup>(1)</sup>	CHIP ADDRESS (write)	A <sup>(2)</sup>	SUBADDRESS	A <sup>(2)</sup>	DATA BYTE(S)	A <sup>(2)</sup>	P <sup>(3)</sup>
------------------	----------------------	------------------	------------	------------------	--------------	------------------	------------------

**Notes**

1. S = START condition.
2. A = acknowledge.
3. P = STOP condition.

**Table 2** Read mode

S <sup>(1)</sup>	CHIP ADDRESS (read)	A <sup>(2)</sup>	DATA BYTE 1	A <sup>(2)</sup>	DATA BYTE 2	A <sup>(2)</sup>	P <sup>(3)</sup>
------------------	---------------------	------------------	-------------	------------------	-------------	------------------	------------------

**Notes**

1. S = START condition.
2. A = acknowledge.
3. P = STOP condition.

**Table 3** Chip address byte

CHIP ADDRESS							READ/WRITE
0	0	1	1	0	0	0/1 <sup>(1)</sup>	R/ $\overline{W}$ <sup>(2)</sup>

**Notes**

1. Defined by address pin ADR.
2. 0 = receiver and 1 = transmitter.

## Up-level Car radio Analog Signal Processor (CASP)

TEA6886HL

### 11.1 Read mode: 1st data byte

**Table 4** Format of 1st data byte

7	6	5	4	3	2	1	0
STIN	RDSU	LVL5	LVL4	LVL3	LVL2	LVL1	LVL0

**Table 5** Description of 1st data byte bits

BIT	SYMBOL	DESCRIPTION
7	STIN	<b>Stereo indicator.</b> This bit indicates if a pilot signal has been detected. If STIN = 0, then no pilot signal has been detected. If STIN = 1, then a pilot signal has been detected.
6	RDSU	<b>Measure mode.</b> This bit selects the measure mode for the RDS flags. If RDSU = 0, then continuous mode is selected. If RDSU = 1, then RDS update mode is selected.
5 to 0	LVL[5:0]	<b>ADC voltage level.</b> These 6 bits determine the ADC voltage level; see Table 6.

**Table 6** Level setting ADC

V <sub>LEVEL</sub> (V)	LVL5	LVL4	LVL3	LVL2	LVL1	LVL0
3.600	1	1	1	1	1	1
3.553	1	1	1	1	1	0
3.506	1	1	1	1	0	1
3.460	1	1	1	1	0	0
3.413	1	1	1	0	1	1
3.366	1	1	1	0	1	0
3.319	1	1	1	0	0	1
3.272	1	1	1	0	0	0
3.225	1	1	0	1	1	1
3.179	1	1	0	1	1	0
3.132	1	1	0	1	0	1
3.085	1	1	0	1	0	0
3.038	1	1	0	0	1	1
2.991	1	1	0	0	1	0
2.944	1	1	0	0	0	1
2.898	1	1	0	0	0	0
2.851	1	0	1	1	1	1
2.804	1	0	1	1	1	0
2.757	1	0	1	1	0	1
2.710	1	0	1	1	0	0
2.663	1	0	1	0	1	1
2.617	1	0	1	0	1	0
2.570	1	0	1	0	0	1
2.523	1	0	1	0	0	0
2.476	1	0	0	1	1	1
2.429	1	0	0	1	1	0
2.383	1	0	0	1	0	1

# Up-level Car radio Analog Signal Processor (CASP)

TEA6886HL

V <sub>LEVEL</sub> (V)	LVL5	LVL4	LVL3	LVL2	LVL1	LVL0
2.336	1	0	0	1	0	0
2.289	1	0	0	0	1	1
2.242	1	0	0	0	1	0
2.195	1	0	0	0	0	1
2.148	1	0	0	0	0	0
2.102	0	1	1	1	1	1
2.055	0	1	1	1	1	0
2.008	0	1	1	1	0	1
1.961	0	1	1	1	0	0
1.914	0	1	1	0	1	1
1.867	0	1	1	0	1	0
1.821	0	1	1	0	0	1
1.774	0	1	1	0	0	0
1.727	0	1	0	1	1	1
1.680	0	1	0	1	1	0
1.633	0	1	0	1	0	1
1.587	0	1	0	1	0	0
1.540	0	1	0	0	1	1
1.493	0	1	0	0	1	0
1.446	0	1	0	0	0	1
1.399	0	1	0	0	0	0
1.352	0	0	1	1	1	1
1.306	0	0	1	1	1	0
1.259	0	0	1	1	0	1
1.212	0	0	1	1	0	0
1.165	0	0	1	0	1	1
1.118	0	0	1	0	1	0
1.071	0	0	1	0	0	1
1.025	0	0	1	0	0	0
0.978	0	0	0	1	1	1
0.931	0	0	0	1	1	0
0.884	0	0	0	1	0	1
0.837	0	0	0	1	0	0
0.790	0	0	0	0	1	1
0.744	0	0	0	0	1	0
0.697	0	0	0	0	0	1
0.650	0	0	0	0	0	0

# Up-level Car radio Analog Signal Processor (CASP)

TEA6886HL

## 11.2 Read mode: 2nd data byte

**Table 7** Format of 2nd data byte

7	6	5	4	3	2	1	0
–	USN2	USN1	USN0	–	WBA2	WBA1	WBA0

**Table 8** Description of 2nd data byte

BIT	SYMBOL	DESCRIPTION
7	–	This bit is not used and must be set to logic 1.
6	USN2	<b>Ultrasonic noise ADC.</b> These 3 bits select the voltage level for the ultrasonic noise ADC; see Table 9.
5	USN1	
4	USN0	
3	–	This bit is not used and must be set to logic 1.
2	WBA2	<b>AM wideband noise ADC.</b> These 3 bits select the voltage level for the AM wideband ADC; see Table 10.
1	WBA1	
0	WBA0	

**Table 9** Ultrasonic noise ADC

$V_{TUSN2}$ (V)	USN2	USN1	USN0
4.500	1	1	1
4.157	1	1	0
3.814	1	0	1
3.471	1	0	0
3.129	0	1	1
2.786	0	1	0
2.443	0	0	1
2.100	0	0	0

**Table 10** AM wideband noise ADC

$V_{TWBAM2}$ (V)	WBA2	WBA1	WBA0
4.500	1	1	1
4.157	1	1	0
3.814	1	0	1
3.471	1	0	0
3.129	0	1	1
2.786	0	1	0
2.443	0	0	1
2.100	0	0	0

## Up-level Car radio Analog Signal Processor (CASP)

TEA6886HL

### 11.3 Subaddress byte for write

**Table 11** Format for subaddress byte

<b>7</b>	<b>6</b>	<b>5</b>	<b>4</b>	<b>3</b>	<b>2</b>	<b>1</b>	<b>0</b>
AIOF	BOUT	–	–	SAD3	SAD2	SAD1	SAD0

**Table 12** Description of subaddress byte

BIT	SYMBOL	DESCRIPTION
7	AIOF	<b>Auto-increment control.</b> This bit controls the auto-increment function. If AIOF = 0, then the auto-increment is on. If AIOF = 1, then auto-increment is off.
6	BOUT	<b>I<sup>2</sup>C-bus output control.</b> This bit enables/disables the I <sup>2</sup> C-bus output SDAQ and SCLQ to the TEA6840H. If BOUT = 0, then the I <sup>2</sup> C-bus output is disabled. If BOUT = 1, then the I <sup>2</sup> C-bus output is enabled.
5	–	These 2 bits are not used; both must be set to logic 0.
4	–	
3	SAD3	<b>Data byte select.</b> These 4 bits select which data byte is to be addressed; see Table 13.
2	SAD2	
1	SAD1	
0	SAD0	

**Table 13** Selection of data byte

ADDRESSED DATA BYTE	MNEMONIC	SAD3	SAD2	SAD1	SAD0
Alignment 0	ALGN0	0	0	0	0
Alignment 1	ALGN1	0	0	0	1
Alignment 2	ALGN2	0	0	1	0
Alignment 3	ALGN3	0	0	1	1
ASI time source selector	SSEL	0	1	0	0
Bass control	BASS	0	1	0	1
Treble control	TRBL	0	1	1	0
Loudness control	LOUD	0	1	1	1
Volume 1	VOLU1	1	0	0	0
Volume 2, left front	VOL2_LF	1	0	0	1
Volume 2, right front	VOL2_RF	1	0	1	0
Volume 2, left rear	VOL2_LR	1	0	1	1
Volume 2, right rear	VOL2_RR	1	1	0	0
Not used <sup>(1)</sup>	–	1	1	0	1
Not used <sup>(1)</sup>	–	1	1	1	0
Not used <sup>(1)</sup>	–	1	1	1	1

#### Note

1. Not tested; function not guaranteed.

## Up-level Car radio Analog Signal Processor (CASP)

TEA6886HL

### 11.4 Write mode: subaddress 0H

**Table 14** Format of data byte Alignment 0 (ALGN0)

7	6	5	4	3	2	1	0
AMON	AMST	SEAR	SMUT	MMUT	MONO	MST1	MST0

**Table 15** Description of ALGN0 bits

BIT	SYMBOL	DESCRIPTION
7	AMON	<b>AM/FM mode selection.</b> These 2 bits select the AM/FM mode and source; see Table 16.
6	AMST	
5	SEAR	<b>Search mode selection.</b> If SEAR = 0, then mute and SNC detectors normal. If SEAR = 1, then mute and SNC detectors fast.
4	SMUT	<b>Soft mute enable.</b> If SMUT = 0, then soft mute off. If SMUT = 1, then soft mute enabled.
3	MMUT	<b>Muting of MPX output.</b> If MMUT = 0, then MPX output not muted. If MMUT = 1, then MPX output muted.
2	MONO	<b>Stereo decoder mode selection.</b> If MONO = 0, then Stereo mode selected. If MONO = 1, then Mono mode selected.
1	MST1	<b>Start of muting.</b> These 2 bits determine the value of $V_{TMUTE}$ ; see Table 17 and Fig.4.
0	MST0	

**Table 16** Setting of AM/FM mode

SELECTED MODE	AMON	AMST
AM stereo mode, note 1	1	1
AM mode, active input AMHIN	1	0
Not allowed	0	1
FM mode, active input MPXIN	0	0

#### Note

- MPX input (MPXIN) and AM input (AMHIN) muted, stereo decoder in mono mode and de-emphasis terminals (DEEML and DEEMR) are audio signal inputs.

**Table 17** Setting of start of muting ( $\alpha_{MUTE} = 6$  dB)

$V_{TMUTE}$ (V)	MST1	MST0
2.45	1	1
2.30	1	0
2.15	0	1
2.00	0	0

Up-level Car radio Analog Signal Processor (CASP)

TEA6886HL

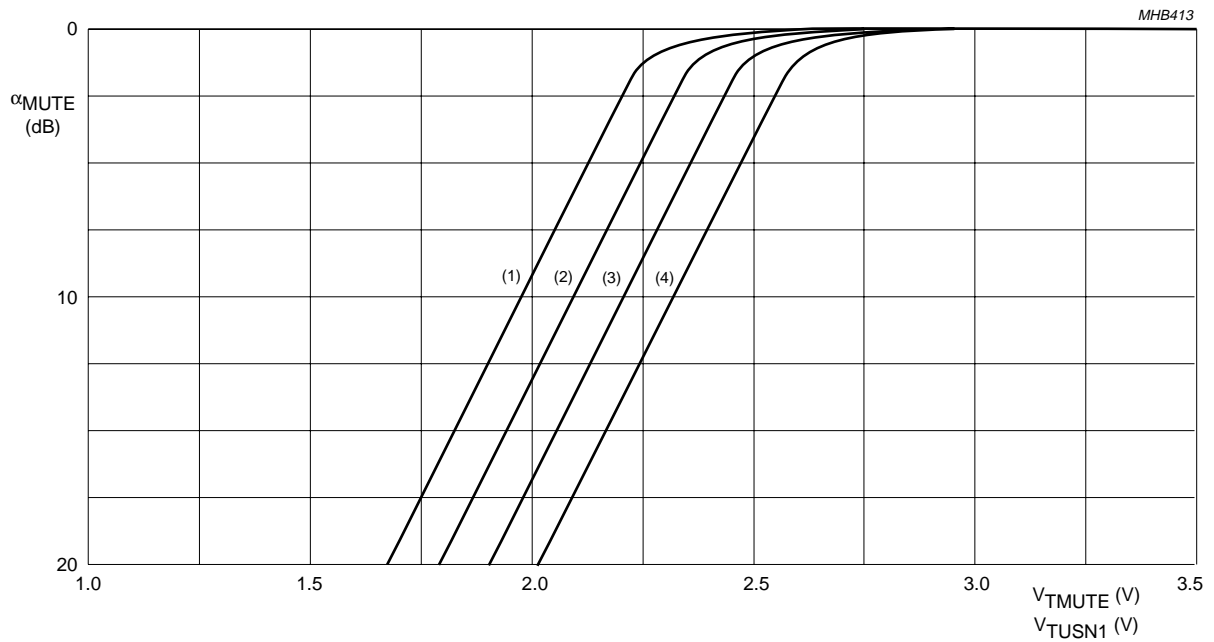

**Data byte ALGN2:** MSL0 = 1, MSL1 = 1

**Data byte ALGN0**

CURVE	MST1	MST0
(1)	0	0
(2)	0	1
(3)	1	0
(4)	1	1

Fig.4 Soft mute attenuation as a function of  $V_{TMUTE}$  and  $V_{TUSN1}$  input voltage (fixed slope).

## Up-level Car radio Analog Signal Processor (CASP)

TEA6886HL

### 11.5 Write mode: subaddress 1H

**Table 18** Format of data byte Alignment 1 (ALGN1)

7	6	5	4	3	2	1	0
USS1	USS0	AWS1	AWS0	CHS3	CHS2	CHS1	CHS0

**Table 19** Description of ALGN1 bits

BIT	SYMBOL	DESCRIPTION
7	USS1	<b>Ultrasonic noise sensitivity.</b> These 2 bits determine the ultrasonic noise sensitivity levels; see Table 20 and Fig.5.
6	USS0	
5	AWS1	<b>AM wideband sensitivity.</b> These 2 bits determine the AM wideband sensitivity levels; see Table 21 and Fig.6.
4	AWS0	
3	CHS3	<b>Channel separation alignment.</b> These 4 bits select the channel separation alignment; see Table 22.
2	CHS2	
1	CHS1	
0	CHS0	

**Table 20** Setting of ultrasonic noise sensitivity ( $V_{MPXRDS(AC)} = 350$  mV)

SLOPE (V/V)	USS1	USS0
-2.1	1	1
-2.9	1	0
-4.4	0	1
-6.8	0	0



Up-level Car radio Analog Signal Processor (CASP)

TEA6886HL

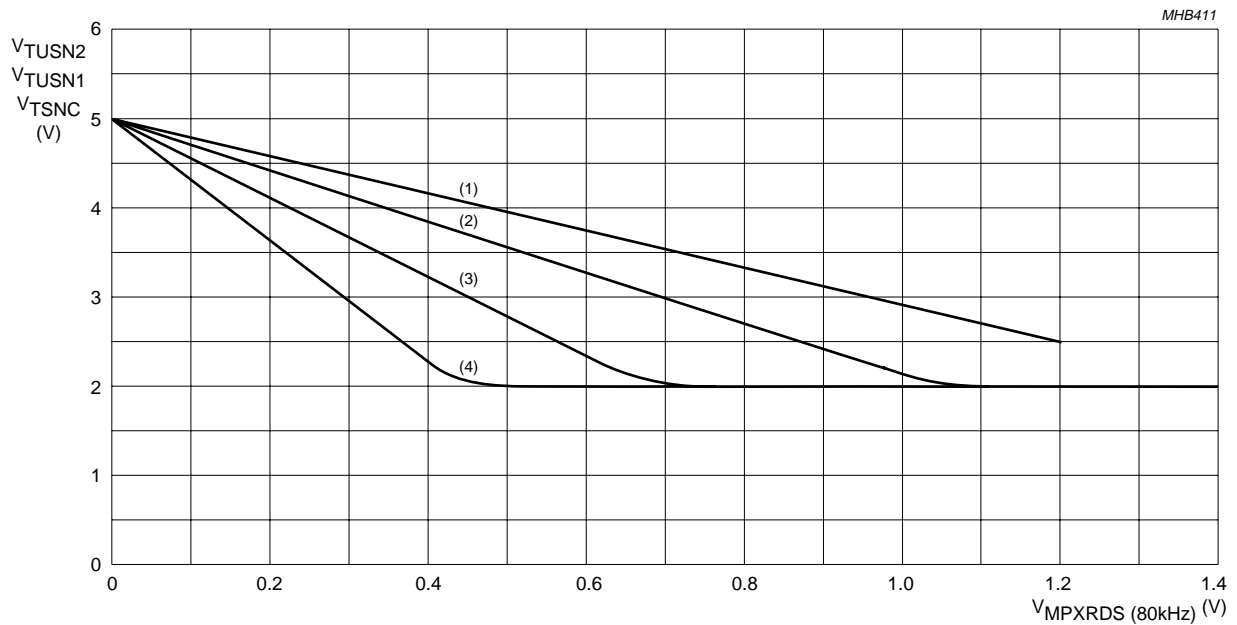

Data byte ALGN1

CURVE	USS1	USS0
(1)	1	1
(2)	1	0
(3)	0	1
(4)	0	0

Fig.5 Ultrasonic noise peak and average detector output voltage as a function of MPX signal input, and stereo noise control peak detector output voltage as a function of MPX signal input.

Up-level Car radio Analog Signal Processor (CASP)

TEA6886HL

**Table 21** Setting of AM wideband sensitivity ( $V_{LEVEL(AC)} = 400 \text{ mV}$ )

SLOPE (V/V)	AWS1	AWS0
-2.2	1	1
-3.3	1	0
-4.9	0	1
-6.5	0	0

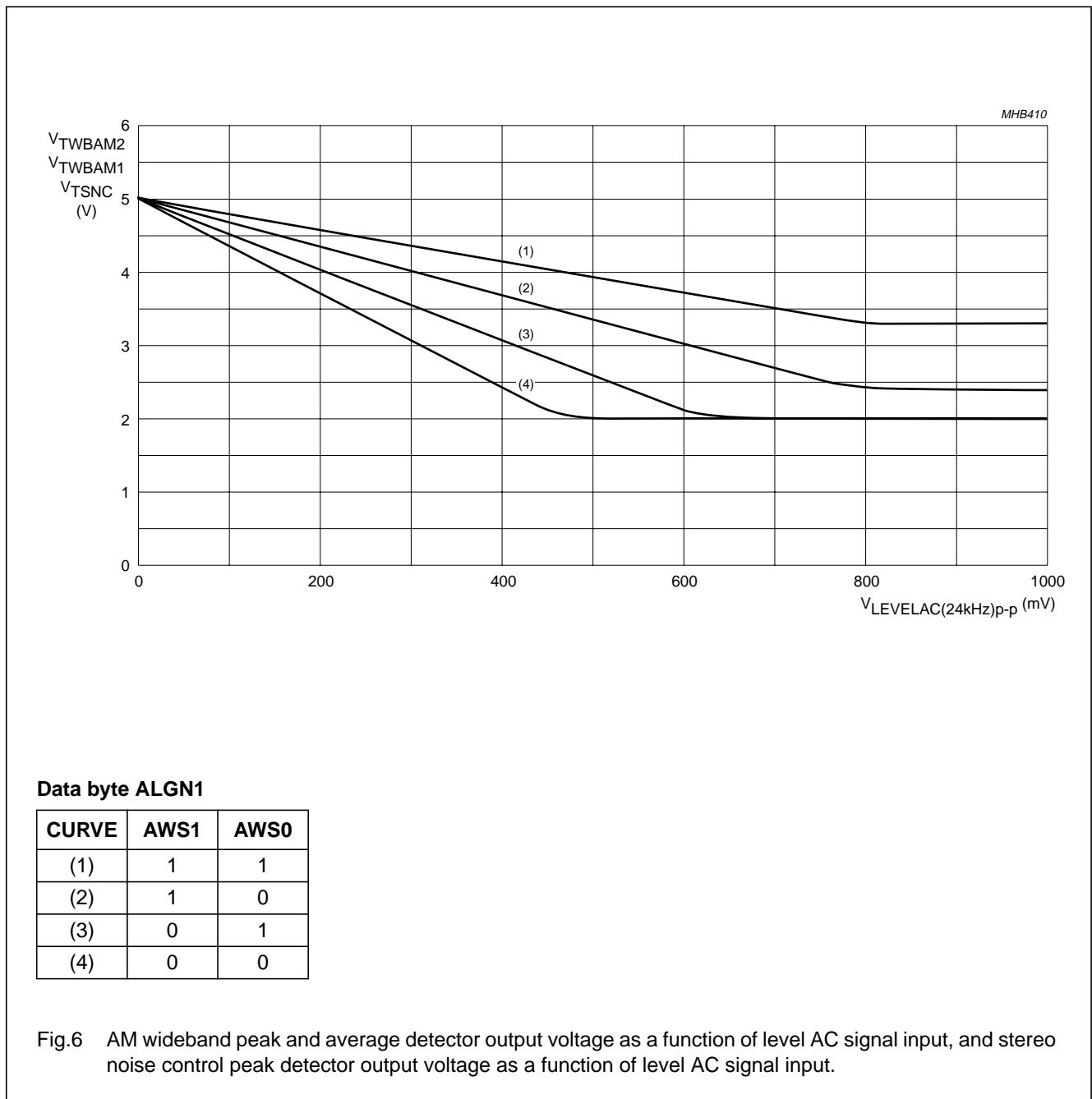

# Up-level Car radio Analog Signal Processor (CASP)

TEA6886HL

**Table 22** Setting of channel separation alignment

CHANNEL SEPARATION ALIGNMENT	CHS3	CHS2	CHS1	CHS0
Not used <sup>(1)</sup>	1	1	1	1
Not used <sup>(1)</sup>	1	1	1	0
Not used <sup>(1)</sup>	1	1	0	1
Not used <sup>(1)</sup>	1	1	0	0
Not used <sup>(1)</sup>	1	0	1	1
Not used <sup>(1)</sup>	1	0	1	0
Setting 9, minimum gain of side signal	1	0	0	1
Setting 8	1	0	0	0
Setting 7	0	1	1	1
Setting 6	0	1	1	0
Setting 5	0	1	0	1
Setting 4	0	1	0	0
Setting 3	0	0	1	1
Setting 2	0	0	1	0
Setting 1	0	0	0	1
Setting 0, maximum gain of side signal	0	0	0	0

**Note**

1. Not tested; function not guaranteed.

**11.6 Write mode: subaddress 2H****Table 23** Format of data byte Alignment 2 (ALGN2)

7	6	5	4	3	2	1	0
MSL1	MSL0	SSL1	SSL0	SST3	SST2	SST1	SST0

**Table 24** Description of ALGN2 bits

BIT	SYMBOL	DESCRIPTION
7	MSL1	<b>Soft mute slope alignment.</b> These 2 bits determine the value of $V_{TMUTE(DC)}$ ; see Table 25 and Fig.7.
6	MSL0	
5	SSL1	<b>Stereo noise control slope alignment.</b> These 2 bits determine the value of $\alpha_{CS}$ ; see Table 26 and Fig.8.
4	SSL0	
3	SST3	<b>Stereo noise control start alignment.</b> These 4 bits determine the stereo noise control start alignment; see Table 27 and Fig.9.
2	SST2	
1	SST1	
0	SST0	

Up-level Car radio Analog Signal Processor (CASP)

TEA6886HL

**Table 25** Setting of soft mute slope alignment

$V_{TMUTE(DC)}$	MSL1	MSL0
$0.395V_{TUSN1}$ without AC	1	1
$0.390V_{TUSN1}$ without AC	1	0
$0.380V_{TUSN1}$ without AC	0	1
$0.350V_{TUSN1}$ without AC	0	0

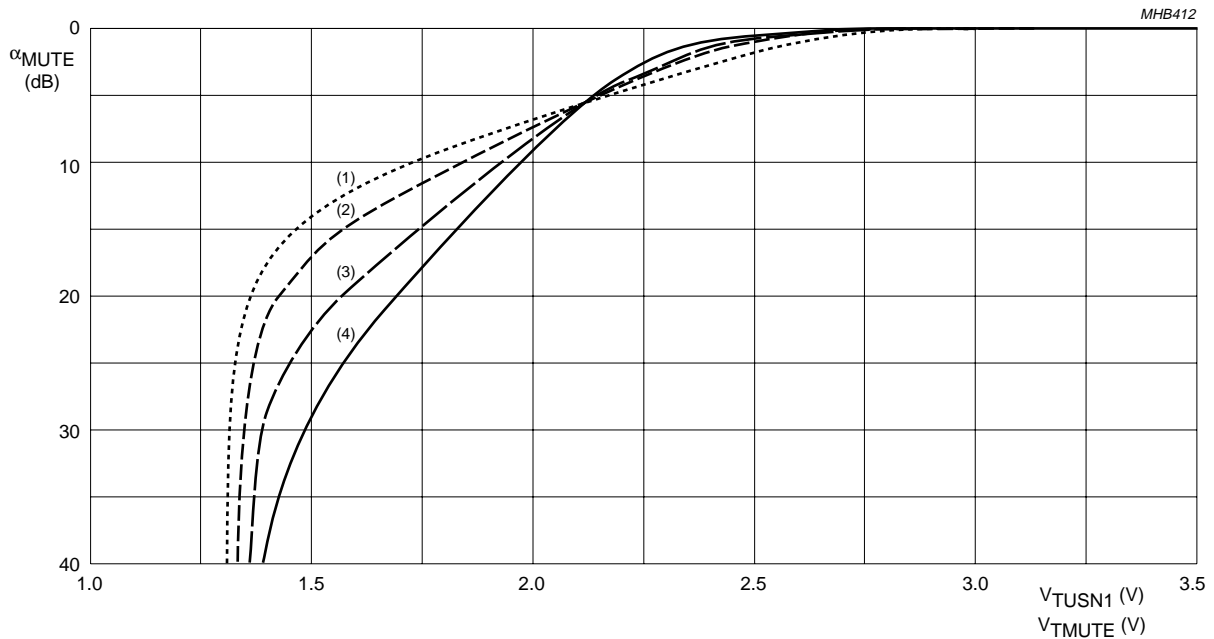

**Data byte ALGN0:** MST0 = 0, MST1 = 0

**Data byte ALGN2**

CURVE	MSL1	MSL0
(1)	0	0
(2)	0	1
(3)	1	0
(4)	1	1

Fig.7 Soft mute attenuation as a function of input voltages  $V_{TUSN1}$  and  $V_{TMUTE}$  (fixed start).

Up-level Car radio Analog Signal Processor (CASP)

TEA6886HL

**Table 26** Setting of stereo noise control slope alignment ( $V_{TSNC} = 0.72V_{TUSN1}$  without AC)

$\alpha_{cs}$ (dB)	SSL1	SSL0
Not defined	1	1
13	1	0
7	0	1
5	0	0

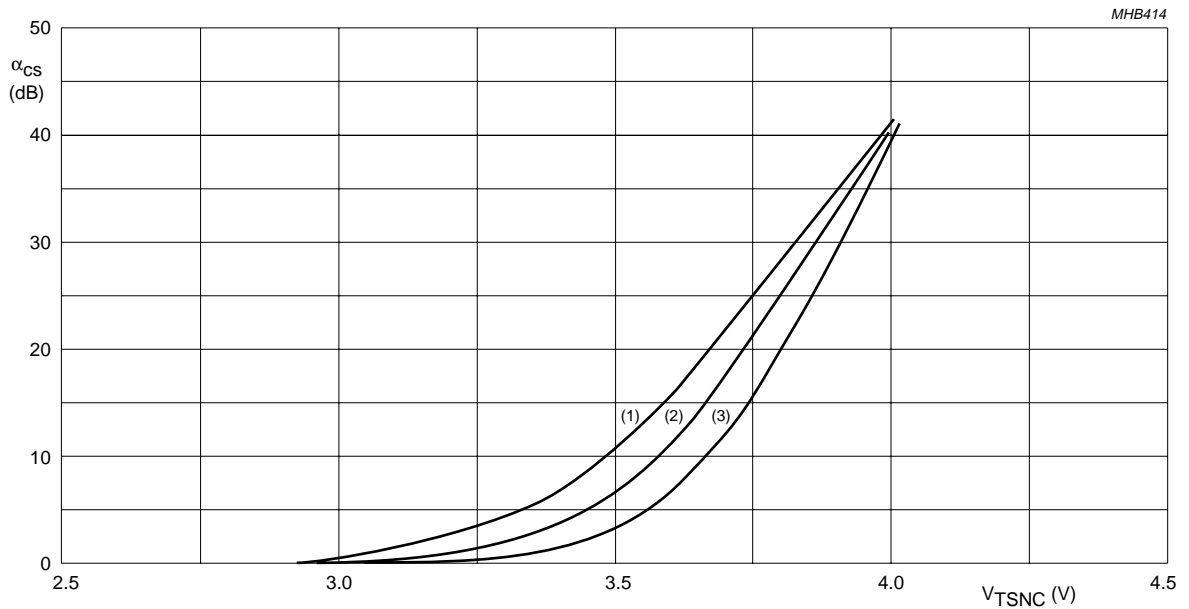

**Data byte ALGN2:** SST = 1000

**Data byte ALGN2**

CURVE	SSL0	SSL1
(1)	0	1
(2)	1	0
(3)	0	0

Fig.8 Channel separation as a function of voltage at pins TSNC, TWBAM1 and TUSN1 (fixed start).

# Up-level Car radio Analog Signal Processor (CASP)

TEA6886HL

**Table 27** Setting of stereo noise control start alignment ( $\alpha_{cs} = 6$  dB)

START ALIGNMENT	SST3	SST2	SST1	SST0
$V_{TSNC} = 0.63V_{TUSN1}$ without AC	1	1	1	1
$V_{TSNC}$	1	1	1	0
$V_{TSNC}$	1	1	0	1
$V_{TSNC}$	1	1	0	0
$V_{TSNC}$	1	0	1	1
$V_{TSNC}$	1	0	1	0
$V_{TSNC}$	1	0	0	1
$V_{TSNC} = 0.70V_{TUSN1}$ without AC	1	0	0	0
$V_{TSNC}$	0	1	1	1
$V_{TSNC}$	0	1	1	0
$V_{TSNC}$	0	1	0	1
$V_{TSNC}$	0	1	0	0
$V_{TSNC}$	0	0	1	1
$V_{TSNC}$	0	0	1	0
$V_{TSNC}$	0	0	0	1
$V_{TSNC} = 0.74V_{TUSN1}$ without AC	0	0	0	0

Up-level Car radio Analog Signal Processor (CASP)

TEA6886HL

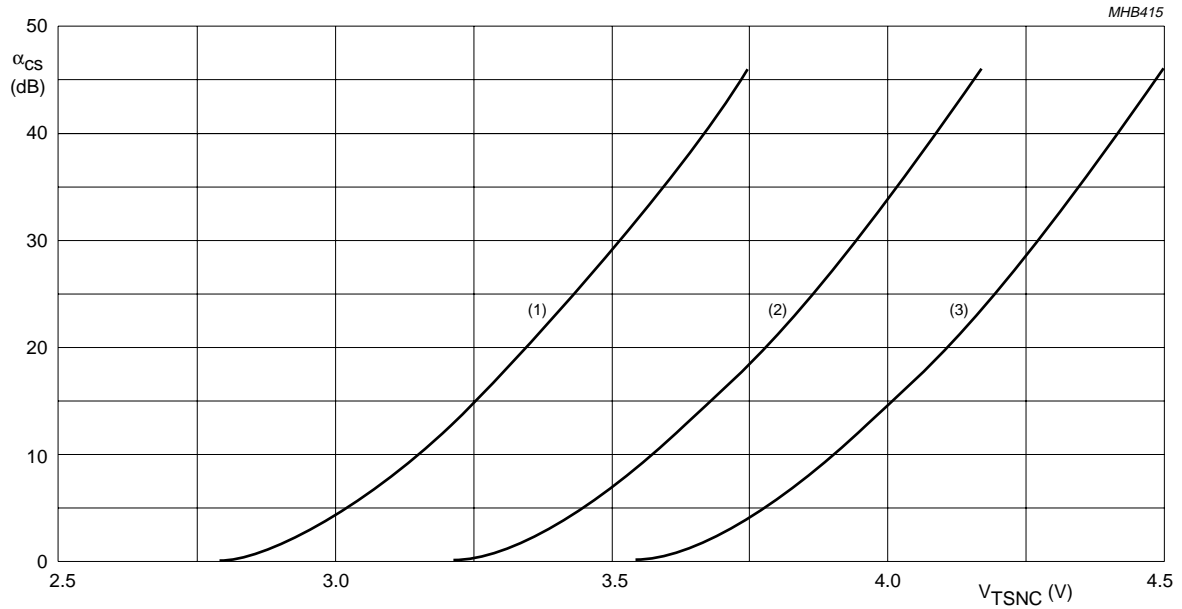

**Data byte ALGN2:** SSL1 = 0, SSL0 = 1

**Data byte ALGN2**

CURVE	SST3	SST2	SST1	SST0
(1)	0	0	0	0
(2)	1	0	0	0
(3)	1	1	1	1

Fig.9 Channel separation as a function of voltage at pins TSNC, TWBAM1 and TUSN1 (fixed slope).

## Up-level Car radio Analog Signal Processor (CASP)

TEA6886HL

### 11.7 Write mode: subaddress 3H

**Table 28** Format of data byte Alignment 3 (ALGN3)

7	6	5	4	3	2	1	0
NBS1	NBS0	DE75	HCCS	HST1	HST0	HSL1	HSL0

**Table 29** Description of ALGN3 bits

BIT	SYMBOL	DESCRIPTION
7	NBS1	<b>Noise blanker sensitivity.</b> These 2 bits determine the noise blanker sensitivity levels; see Table 30.
6	NBS0	
5	DE75	<b>De-emphasis.</b> If DE75 = 1, then de-emphasis is 75 $\mu$ s. If DE75 = 0, then de-emphasis is 50 $\mu$ s.
4	HCCS	<b>HCC control switch.</b> With static roll-off: HCCS = 1, $C_{FMLBUF} = C_{FMRBUF} = 2.7$ nF. Without static roll-off: HCCS = 0, $C_{FMLBUF} = C_{FMRBUF} = 680$ pF.
3	HST1	<b>HCC start alignment.</b> These 2 bits determine the alignment for the start of high cut control; see Table 31 and Fig.10.
2	HST0	
1	HSL1	<b>HCC slope alignment.</b> These 2 bits determine the alignment for the slope of high cut control; see Table 32 and Fig.11.
0	HSL0	

**Table 30** Setting of noise blanker sensitivity

$V_{\text{pulse(p)}(\text{MPX})}$ (mV)	$V_{\text{pulse(p)}(\text{level})}$ (mV)	NBS1	NBS0
12	110	1	1
24	120	1	0
60	150	0	1
120	200	0	0

**Table 31** Setting of alignment for start of high cut control ( $\alpha_{10\text{kHz}} = 3$  dB)

$V_{\text{LEVEL(DC)}}$ (V)	HST1	HST0
1.30	1	1
1.45	1	0
1.90	0	1
2.10	0	0



Up-level Car radio Analog Signal Processor (CASP)

TEA6886HL

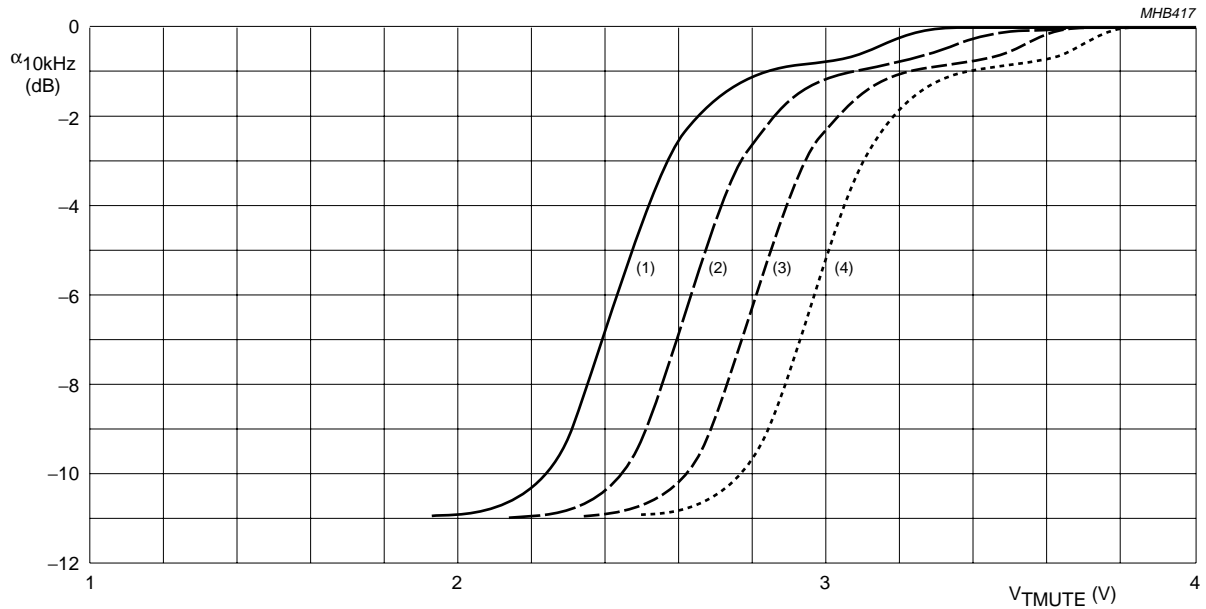

Data byte ALGN3: HSL1 = 1, HSL0 = 0

Data byte ALGN3

CURVE	HST1	HST0
(1)	1	1
(2)	1	0
(3)	0	1
(4)	0	0

Fig.10 High cut control as a function of  $V_{TMUTE}$  (fixed slope).

Up-level Car radio Analog Signal Processor (CASP)

TEA6886HL

**Table 32** Setting of alignment for slope of high cut control ( $V_{TMUTE} = 2.4\text{ V}$ )

$\alpha_{10\text{kHz}}$ (dB)	HSL1	HSL0
7.5	1	1
6.0	1	0
4.0	0	1
3.0	0	0

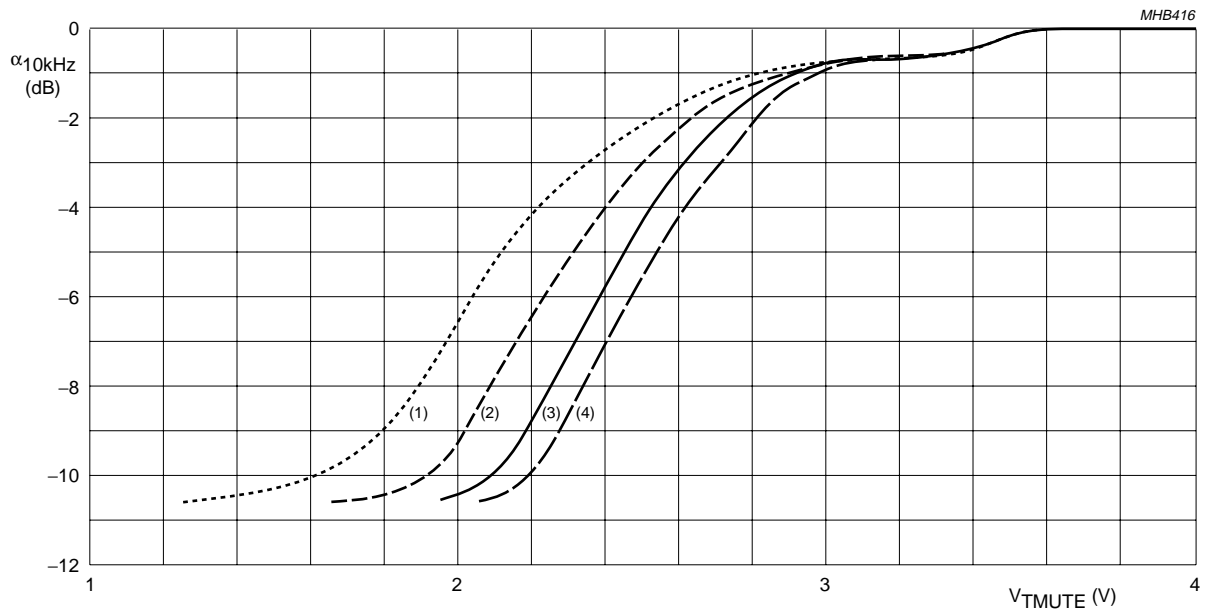

Data byte ALGN3: HST1 = 1, HST0 = 1

Data byte ALGN3

CURVE	HSL1	HSL0
(1)	0	0
(2)	0	1
(3)	1	0
(4)	1	1

Fig.11 High cut control as a function of  $V_{TMUTE}$  (fixed start).

# Up-level Car radio Analog Signal Processor (CASP)

TEA6886HL

## 11.8 Write mode: subaddress 4H

**Table 33** Format of data byte Source Selector (SSEL)

7	6	5	4	3	2	1	0
ASI1	ASI0	RSA2	RSA1	RSA0	MSS2	MSS1	MSS0

**Table 34** Description of SSEL bits

BIT	SYMBOL	DESCRIPTION
7	ASI1	<b>ASI/ABC speed selection.</b> These 2 bits select the ASI/ABC speed (time per step); see Table 35.
6	ASI0	
5	RSA2	<b>Rear seat audio selector.</b> These 3 bits select the source for the rear outputs; see Table 36.
4	RSA1	
3	RSA0	
2	MSS2	<b>Main source selector.</b> These 3 bits select the source for the main control part; see Table 37.
1	MSS1	
0	MSS0	

**Table 35** ASI/ABC speed selection ( $C_{ASICAP} = 15 \text{ nF}$ )

ASI/ABC SPEED (ms)	ASI1	ASI0
20	1	1
8.33	1	0
3.33	0	1
0.83	0	0

**Table 36** Selected source for rear outputs

SELECTED SOURCE	RSA2	RSA1	RSA0
Internal, main channel <sup>(1)</sup>	1	1	1
Internal, main channel <sup>(1)</sup>	1	1	0
Internal, main channel <sup>(1)</sup>	1	0	1
Internal, main channel	1	0	0
AM/FM (internal)	0	1	1
Input A (stereo)	0	1	0
Input B (stereo)	0	0	1
Input C (stereo, symmetrical)	0	0	0

### Note

1. Not tested; function not guaranteed.

# Up-level Car radio Analog Signal Processor (CASP)

TEA6886HL

**Table 37** Selected source for main control part

SELECTED SOURCE	MSS2	MSS1	MSS0
Chime input <sup>(1)</sup>	1	1	1
Chime input <sup>(1)</sup>	1	1	0
Chime input	1	0	1
Input D (mono, symmetrical)	1	0	0
AM/FM (internal)	0	1	1
Input A (stereo)	0	1	0
Input B (stereo)	0	0	1
Input C (stereo, symmetrical)	0	0	0

**Note**

1. Not tested; function not guaranteed.

**11.9 Write mode: subaddress 5H****Table 38** Format of data byte Bass control (BASS)

7	6	5	4	3	2	1	0
BSYC	–	BSYB	BAS4	BAS3	BAS2	BAS1	BAS0

**Table 39** Description of BASS bits

BIT	SYMBOL	DESCRIPTION
7	BSYC	<b>Bass filter mode for cut.</b> If BSYC = 0, then shelving characteristic selected. If BSYC = 1, then band-pass filter characteristic selected.
6	–	This bit is not used and must be set to logic 0.
5	BSYB	<b>Bass filter mode for boost.</b> If BSYB = 0, then shelving characteristic selected. If BSYB = 1, then band-pass filter characteristic selected.
4	BAS4	<b>Bass control.</b> These 5 bits determine the bass control level; see Table 40.
3	BAS3	
2	BAS2	
1	BAS1	
0	BAS0	

# Up-level Car radio Analog Signal Processor (CASP)

TEA6886HL

**Table 40** Setting of bass control level

BASS CONTROL (dB)	BAS4	BAS3	BAS2	BAS1	BAS0
+18 <sup>(1)</sup>	1	1	1	1	1
+18 <sup>(1)</sup>	1	1	1	1	0
+18 <sup>(1)</sup>	1	1	1	0	1
+18 <sup>(1)</sup>	1	1	1	0	0
+18 <sup>(1)</sup>	1	1	0	1	1
+18	1	1	0	1	0
+16	1	1	0	0	1
+14	1	1	0	0	0
+12	1	0	1	1	1
+10	1	0	1	1	0
+8	1	0	1	0	1
+6	1	0	1	0	0
+4	1	0	0	1	1
+2	1	0	0	1	0
+0	1	0	0	0	1
-0	1	0	0	0	0
-2 (-1.8)	0	1	1	1	1
-4 (-3.6)	0	1	1	1	0
-6 (-5.4)	0	1	1	0	1
-8 (-7.1)	0	1	1	0	0
-10 (-8.7)	0	1	0	1	1
-12 (-10.3)	0	1	0	1	0
-14 (-11.7)	0	1	0	0	1
-16 (-13.1)	0	1	0	0	0
-18 (-14.4)	0	0	1	1	1
-18 (-14.4) <sup>(1)</sup>	0	0	1	1	0
-18 (-14.4) <sup>(1)</sup>	0	0	1	0	1
-18 (-14.4) <sup>(1)</sup>	0	0	1	0	0
-18 (-14.4) <sup>(1)</sup>	0	0	0	1	1
-18 (-14.4) <sup>(1)</sup>	0	0	0	1	0
-18 (-14.4) <sup>(1)</sup>	0	0	0	0	1
-18 (-14.4) <sup>(1)</sup>	0	0	0	0	0

**Note**

1. Not tested; function not guaranteed.

# Up-level Car radio Analog Signal Processor (CASP)

TEA6886HL

## 11.10 Write mode: subaddress 6H

**Table 41** Format of data byte Treble control (TRBL)

7	6	5	4	3	2	1	0
HSTM	–	–	–	TRE3	TRE2	TRE1	TRE0

**Table 42** Description of TRBL bits

BIT	SYMBOL	DESCRIPTION
7	HSTM	<b>Test mode muting average and SNC peak detector.</b> If HSTM = 0, then normal operation. If HSTM = 1, then increased detector currents.
6	–	These 3 bits are not used; each must be set to logic 0.
5	–	
4	–	
3	TRE3	<b>Treble control.</b> These 4 bits determine the treble control level; see Table 43.
2	TRE2	
1	TRE1	
0	TRE0	

**Table 43** Setting of treble control level

TREBLE CONTROL (dB)	TRE3	TRE2	TRE1	TRE0
+14	1	1	1	1
+12	1	1	1	0
+10	1	1	0	1
+8	1	1	0	0
+6	1	0	1	1
+4	1	0	1	0
+2	1	0	0	1
+0	1	0	0	0
–0	0	1	1	1
–2	0	1	1	0
–4	0	1	0	1
–6	0	1	0	0
–8	0	0	1	1
–10	0	0	1	0
–12	0	0	0	1
–14	0	0	0	0

## Up-level Car radio Analog Signal Processor (CASP)

TEA6886HL

### 11.11 Write mode: subaddress 7H

**Table 44** Format of data byte Loudness control (LOUD)

<b>7</b>	<b>6</b>	<b>5</b>	<b>4</b>	<b>3</b>	<b>2</b>	<b>1</b>	<b>0</b>
LOFF	–	–	LSN4	LSN3	LSN2	LSN1	LSN0

**Table 45** Description of LOUD bits

BIT	SYMBOL	DESCRIPTION
7	LOFF	<b>Loudness switch control.</b> If LOFF = 0, then the loudness switch is on. If LOFF = 1, then loudness switch is off.
6	–	These 2 bits are not used, each must be set to logic 0.
5	–	
4	LSN4	<b>Loudness control.</b> These 5 bits determine the attenuation of the loudness block; see Table 46.
3	LSN3	
2	LSN2	
1	LSN1	
0	LSN0	

**Table 46** Attenuation of loudness block

ATTENUATION (dB)	LSN4	LSN3	LSN2	LSN1	LSN0
0	1	1	1	1	1
–1	1	1	1	1	0
–2	1	1	1	0	1
–3	1	1	1	0	0
–4	1	1	0	1	1
–5	1	1	0	1	0
–6	1	1	0	0	1
–7	1	1	0	0	0
–8	1	0	1	1	1
–9	1	0	1	1	0
–10	1	0	1	0	1
–11	1	0	1	0	0
–12	1	0	0	1	1
–13	1	0	0	1	0
–14	1	0	0	0	1
–15	1	0	0	0	0
–16	0	1	1	1	1
–17	0	1	1	1	0
–18	0	1	1	0	1
–19	0	1	1	0	0
–20	0	1	0	1	1
–20 <sup>(1)</sup>	0	1	0	1	0
–20 <sup>(1)</sup>	0	1	0	0	1

---

**Up-level Car radio Analog Signal  
Processor (CASP)**

---

**TEA6886HL**

<b>ATTENUATION (dB)</b>	<b>LSN4</b>	<b>LSN3</b>	<b>LSN2</b>	<b>LSN1</b>	<b>LSN0</b>
-20 <sup>(1)</sup>	0	1	0	0	0
-20 <sup>(1)</sup>	0	0	1	1	1
-20 <sup>(1)</sup>	0	0	1	1	0
-20 <sup>(1)</sup>	0	0	1	0	1
-20 <sup>(1)</sup>	0	0	1	0	0
-20 <sup>(1)</sup>	0	0	0	1	1
-20 <sup>(1)</sup>	0	0	0	1	0
-20 <sup>(1)</sup>	0	0	0	0	1
-20 <sup>(1)</sup>	0	0	0	0	0

**Note**

1. Not tested; function not guaranteed.



## Up-level Car radio Analog Signal Processor (CASP)

TEA6886HL

### 11.12 Write mode: subaddress 8H

**Table 47** Format of data byte Volume 1 control (VOLUME1)

7	6	5	4	3	2	1	0
AMUT	–	VOL5	VOL4	VOL3	VOL2	VOL1	VOL0

**Table 48** Description of VOLUME1 bits

BIT	SYMBOL	DESCRIPTION
7	AMUT	<b>Audio mute switch.</b> If AMUT = 0, then there is no audio mute. If AMUT = 1, then audio mute on.
6	–	This bit is not used and must be set to logic 0.
5 to 0	VOL[5:0]	<b>Volume 1 control.</b> These 6 bits determine the attenuation of volume 1 block; see Table 49.

**Table 49** Attenuation of volume 1 block

ATTENUATION (dB)	VOL5	VOL4	VOL3	VOL2	VOL1	VOL0
+20 <sup>(1)</sup>	1	1	1	1	1	1
+20 <sup>(1)</sup>	1	1	1	1	1	0
+20 <sup>(1)</sup>	1	1	1	1	0	1
+20	1	1	1	1	0	0
+19	1	1	1	0	1	1
+18	1	1	1	0	1	0
+17	1	1	1	0	0	1
+16	1	1	1	0	0	0
+15	1	1	0	1	1	1
+14	1	1	0	1	1	0
+13	1	1	0	1	0	1
+12	1	1	0	1	0	0
+11	1	1	0	0	1	1
+10	1	1	0	0	1	0
+9	1	1	0	0	0	1
+8	1	1	0	0	0	0
+7	1	0	1	1	1	1
+6	1	0	1	1	1	0
+5	1	0	1	1	0	1
+4	1	0	1	1	0	0
+3	1	0	1	0	1	1
+2	1	0	1	0	1	0
+1	1	0	1	0	0	1
0	1	0	1	0	0	0
–1	1	0	0	1	1	1
–2	1	0	0	1	1	0
–3	1	0	0	1	0	1

# Up-level Car radio Analog Signal Processor (CASP)

TEA6886HL

ATTENUATION (dB)	VOL5	VOL4	VOL3	VOL2	VOL1	VOL0
-4	1	0	0	1	0	0
-5	1	0	0	0	1	1
-6	1	0	0	0	1	0
-7	1	0	0	0	0	1
-8	1	0	0	0	0	0
-9	0	1	1	1	1	1
-10	0	1	1	1	1	0
-11	0	1	1	1	0	1
-12	0	1	1	1	0	0
-13	0	1	1	0	1	1
-14	0	1	1	0	1	0
-15	0	1	1	0	0	1
-16	0	1	1	0	0	0
-17	0	1	0	1	1	1
-18	0	1	0	1	1	0
-19	0	1	0	1	0	1
-20	0	1	0	1	0	0
-21	0	1	0	0	1	1
-22	0	1	0	0	1	0
-23	0	1	0	0	0	1
-24	0	1	0	0	0	0
-25	0	0	1	1	1	1
-26	0	0	1	1	1	0
-27	0	0	1	1	0	1
-28	0	0	1	1	0	0
-29	0	0	1	0	1	1
-30	0	0	1	0	1	0
-31	0	0	1	0	0	1
-32	0	0	1	0	0	0
-33	0	0	0	1	1	1
-34	0	0	0	1	1	0
-35	0	0	0	1	0	1
-36	0	0	0	1	0	0
-36 <sup>(1)</sup>	0	0	0	0	1	1
-36 <sup>(1)</sup>	0	0	0	0	1	0
-36 <sup>(1)</sup>	0	0	0	0	0	1
-36 <sup>(1)</sup>	0	0	0	0	0	0

**Note**

1. Not tested; function not guaranteed.

## Up-level Car radio Analog Signal Processor (CASP)

TEA6886HL

### 11.13 Write mode: subaddress 9H

**Table 50** Format of data byte Volume 2, left front (VOL2\_LF)

<b>7</b>	<b>6</b>	<b>5</b>	<b>4</b>	<b>3</b>	<b>2</b>	<b>1</b>	<b>0</b>
CHML	–	VLF5	VLF4	VLF3	VLF2	VLF1	VLF0

**Table 51** Description of VOL2\_LF bits

BIT	SYMBOL	DESCRIPTION
7	CHML	<b>Chime adder left front select.</b> If CHML = 1, then chime on. If CHML = 0, then chime off.
6	–	This bit is not used and must be set to logic 0.
5 to 0	VLF[5:0]	<b>Left front volume 2, balance and fader control.</b> These 6 bits determine the attenuation of volume 2 left front; see Table 52.

**Table 52** Attenuation of volume 2 left front

ATTENUATION (dB)	VLF5	VLF4	VLF3	VLF2	VLF1	VLF0
0	1	1	1	1	1	1
–1	1	1	1	1	1	0
–2	1	1	1	1	0	1
–3	1	1	1	1	0	0
–4	1	1	1	0	1	1
–5	1	1	1	0	1	0
–6	1	1	1	0	0	1
–7	1	1	1	0	0	0
–8	1	1	0	1	1	1
–9	1	1	0	1	1	0
–10	1	1	0	1	0	1
–11	1	1	0	1	0	0
–12	1	1	0	0	1	1
–13	1	1	0	0	1	0
–14	1	1	0	0	0	1
–15	1	1	0	0	0	0
–16	1	0	1	1	1	1
–17	1	0	1	1	1	0
–18	1	0	1	1	0	1
–19	1	0	1	1	0	0
–20	1	0	1	0	1	1
–21	1	0	1	0	1	0
–22	1	0	1	0	0	1
–23	1	0	1	0	0	0
–24	1	0	0	1	1	1
–25	1	0	0	1	1	0
–26	1	0	0	1	0	1

# Up-level Car radio Analog Signal Processor (CASP)

TEA6886HL

ATTENUATION (dB)	VLF5	VLF4	VLF3	VLF2	VLF1	VLF0
-27	1	0	0	1	0	0
-28	1	0	0	0	1	1
-29	1	0	0	0	1	0
-30	1	0	0	0	0	1
-31	1	0	0	0	0	0
-32	0	1	1	1	1	1
-33	0	1	1	1	1	0
-34	0	1	1	1	0	1
-35	0	1	1	1	0	0
-36	0	1	1	0	1	1
-37	0	1	1	0	1	0
-38	0	1	1	0	0	1
-39	0	1	1	0	0	0
-40	0	1	0	1	1	1
-41	0	1	0	1	1	0
-42	0	1	0	1	0	1
-43	0	1	0	1	0	0
-44	0	1	0	0	1	1
-45	0	1	0	0	1	0
-46	0	1	0	0	0	1
-47	0	1	0	0	0	0
-48	0	0	1	1	1	1
-49	0	0	1	1	1	0
-50	0	0	1	1	0	1
-51	0	0	1	1	0	0
-52	0	0	1	0	1	1
-53	0	0	1	0	1	0
-54	0	0	1	0	0	1
-55	0	0	1	0	0	0
-56	0	0	0	1	1	1
-58.5	0	0	0	1	1	0
-62	0	0	0	1	0	1
-68	0	0	0	1	0	0
Mute left front	0	0	0	0	1	1
Mute left front <sup>(1)</sup>	0	0	0	0	1	0
Mute left front <sup>(1)</sup>	0	0	0	0	0	1
Mute left front <sup>(1)</sup>	0	0	0	0	0	0

**Note**

1. Not tested; function not guaranteed.

## Up-level Car radio Analog Signal Processor (CASP)

TEA6886HL

### 11.14 Write mode: subaddress AH

**Table 53** Format of data byte Volume 2, right front (VOL2\_RF)

<b>7</b>	<b>6</b>	<b>5</b>	<b>4</b>	<b>3</b>	<b>2</b>	<b>1</b>	<b>0</b>
CHMR	–	VRF5	VRF4	VRF3	VRF2	VRF1	VRF0

**Table 54** Description of VOL2\_RF bits

BIT	SYMBOL	DESCRIPTION
7	CHMR	<b>Chime adder right front select.</b> If CHMR = 1, then chime on. If CHMR = 0, then chime off.
6	–	This bit is not used and must be set to logic 0.
5 to 0	VRF[5:0]	<b>Right front volume 2, balance and fader control.</b> These 6 bits determine the attenuation of volume 2 right front; see Table 55.

**Table 55** Attenuation of volume 2 right front

ATTENUATION (dB)	VRF5	VRF4	VRF3	VRF2	VRF1	VRF0
0	1	1	1	1	1	1
–1	1	1	1	1	1	0
–2	1	1	1	1	0	1
–3	1	1	1	1	0	0
–4	1	1	1	0	1	1
–5	1	1	1	0	1	0
–6	1	1	1	0	0	1
–7	1	1	1	0	0	0
–8	1	1	0	1	1	1
–9	1	1	0	1	1	0
–10	1	1	0	1	0	1
–11	1	1	0	1	0	0
–12	1	1	0	0	1	1
–13	1	1	0	0	1	0
–14	1	1	0	0	0	1
–15	1	1	0	0	0	0
–16	1	0	1	1	1	1
–17	1	0	1	1	1	0
–18	1	0	1	1	0	1
–19	1	0	1	1	0	0
–20	1	0	1	0	1	1
–21	1	0	1	0	1	0
–22	1	0	1	0	0	1
–23	1	0	1	0	0	0
–24	1	0	0	1	1	1
–25	1	0	0	1	1	0
–26	1	0	0	1	0	1

# Up-level Car radio Analog Signal Processor (CASP)

TEA6886HL

ATTENUATION (dB)	VRF5	VRF4	VRF3	VRF2	VRF1	VRF0
-27	1	0	0	1	0	0
-28	1	0	0	0	1	1
-29	1	0	0	0	1	0
-30	1	0	0	0	0	1
-31	1	0	0	0	0	0
-32	0	1	1	1	1	1
-33	0	1	1	1	1	0
-34	0	1	1	1	0	1
-35	0	1	1	1	0	0
-36	0	1	1	0	1	1
-37	0	1	1	0	1	0
-38	0	1	1	0	0	1
-39	0	1	1	0	0	0
-40	0	1	0	1	1	1
-41	0	1	0	1	1	0
-42	0	1	0	1	0	1
-43	0	1	0	1	0	0
-44	0	1	0	0	1	1
-45	0	1	0	0	1	0
-46	0	1	0	0	0	1
-47	0	1	0	0	0	0
-48	0	0	1	1	1	1
-49	0	0	1	1	1	0
-50	0	0	1	1	0	1
-51	0	0	1	1	0	0
-52	0	0	1	0	1	1
-53	0	0	1	0	1	0
-54	0	0	1	0	0	1
-55	0	0	1	0	0	0
-56	0	0	0	1	1	1
-58.5	0	0	0	1	1	0
-62	0	0	0	1	0	1
-68	0	0	0	1	0	0
Mute right front	0	0	0	0	1	1
Mute right front <sup>(1)</sup>	0	0	0	0	1	0
Mute right front <sup>(1)</sup>	0	0	0	0	0	1
Mute right front <sup>(1)</sup>	0	0	0	0	0	0

**Note**

1. Not tested; function not guaranteed.

## Up-level Car radio Analog Signal Processor (CASP)

TEA6886HL

### 11.15 Write mode: subaddress BH

**Table 56** Format of data byte Volume 2, left rear (VOL2\_LR)

<b>7</b>	<b>6</b>	<b>5</b>	<b>4</b>	<b>3</b>	<b>2</b>	<b>1</b>	<b>0</b>
–	–	VLR5	VLR4	VLR3	VLR2	VLR1	VLR0

**Table 57** Description of VOL2\_LR bits

BIT	SYMBOL	DESCRIPTION
7	–	These 2 bits are not used, each must be set to logic 0.
6	–	
5 to 0	VLR[5:0]	<b>Left rear volume 2, balance and fader control.</b> These 6 bits determine the attenuation of volume 2 left rear; see Table 58.

**Table 58** Attenuation of volume 2 left rear

ATTENUATION (dB)	VLR5	VLR4	VLR3	VLR2	VLR1	VLR0
0	1	1	1	1	1	1
–1	1	1	1	1	1	0
–2	1	1	1	1	0	1
–3	1	1	1	1	0	0
–4	1	1	1	0	1	1
–5	1	1	1	0	1	0
–6	1	1	1	0	0	1
–7	1	1	1	0	0	0
–8	1	1	0	1	1	1
–9	1	1	0	1	1	0
–10	1	1	0	1	0	1
–11	1	1	0	1	0	0
–12	1	1	0	0	1	1
–13	1	1	0	0	1	0
–14	1	1	0	0	0	1
–15	1	1	0	0	0	0
–16	1	0	1	1	1	1
–17	1	0	1	1	1	0
–18	1	0	1	1	0	1
–19	1	0	1	1	0	0
–20	1	0	1	0	1	1
–21	1	0	1	0	1	0
–22	1	0	1	0	0	1
–23	1	0	1	0	0	0
–24	1	0	0	1	1	1
–25	1	0	0	1	1	0
–26	1	0	0	1	0	1
–27	1	0	0	1	0	0

# Up-level Car radio Analog Signal Processor (CASP)

TEA6886HL

ATTENUATION (dB)	VLR5	VLR4	VLR3	VLR2	VLR1	VLR0
-28	1	0	0	0	1	1
-29	1	0	0	0	1	0
-30	1	0	0	0	0	1
-31	1	0	0	0	0	0
-32	0	1	1	1	1	1
-33	0	1	1	1	1	0
-34	0	1	1	1	0	1
-35	0	1	1	1	0	0
-36	0	1	1	0	1	1
-37	0	1	1	0	1	0
-38	0	1	1	0	0	1
-39	0	1	1	0	0	0
-40	0	1	0	1	1	1
-41	0	1	0	1	1	0
-42	0	1	0	1	0	1
-43	0	1	0	1	0	0
-44	0	1	0	0	1	1
-45	0	1	0	0	1	0
-46	0	1	0	0	0	1
-47	0	1	0	0	0	0
-48	0	0	1	1	1	1
-49	0	0	1	1	1	0
-50	0	0	1	1	0	1
-51	0	0	1	1	0	0
-52	0	0	1	0	1	1
-53	0	0	1	0	1	0
-54	0	0	1	0	0	1
-55	0	0	1	0	0	0
-56	0	0	0	1	1	1
-58.5	0	0	0	1	1	0
-62	0	0	0	1	0	1
-68	0	0	0	1	0	0
Mute left rear	0	0	0	0	1	1
Mute left rear <sup>(1)</sup>	0	0	0	0	1	0
Mute left rear <sup>(1)</sup>	0	0	0	0	0	1
Mute left rear <sup>(1)</sup>	0	0	0	0	0	0

**Note**

1. Not tested; function not guaranteed.



Up-level Car radio Analog Signal Processor (CASP)

TEA6886HL

11.16 Write mode: subaddress CH

Table 59 Format of data byte Volume 2, right rear (VOL2\_RR)

7	6	5	4	3	2	1	0
–	–	VRR5	VRR4	VRR3	VRR2	VRR1	VRR0

Table 60 Description of VOL2\_RR bits

BIT	SYMBOL	DESCRIPTION
7	–	These 2 bits are not used, each must be set to logic 0.
6	–	
5 to 0	VRR[5:0]	<b>Right rear volume 2, balance and fader control.</b> These 6 bits determine the attenuation of volume 2 right rear, see Table 61.

Table 61 Attenuation of volume 2 right rear

ATTENUATION (dB)	VRR5	VRR4	VRR3	VRR2	VRR1	VRR0
0	1	1	1	1	1	1
-1	1	1	1	1	1	0
-2	1	1	1	1	0	1
-3	1	1	1	1	0	0
-4	1	1	1	0	1	1
-5	1	1	1	0	1	0
-6	1	1	1	0	0	1
-7	1	1	1	0	0	0
-8	1	1	0	1	1	1
-9	1	1	0	1	1	0
-10	1	1	0	1	0	1
-11	1	1	0	1	0	0
-12	1	1	0	0	1	1
-13	1	1	0	0	1	0
-14	1	1	0	0	0	1
-15	1	1	0	0	0	0
-16	1	0	1	1	1	1
-17	1	0	1	1	1	0
-18	1	0	1	1	0	1
-19	1	0	1	1	0	0
-20	1	0	1	0	1	1
-21	1	0	1	0	1	0
-22	1	0	1	0	0	1
-23	1	0	1	0	0	0
-24	1	0	0	1	1	1
-25	1	0	0	1	1	0
-26	1	0	0	1	0	1
-27	1	0	0	1	0	0

# Up-level Car radio Analog Signal Processor (CASP)

TEA6886HL

ATTENUATION (dB)	VRR5	VRR4	VRR3	VRR2	VRR1	VRR0
-28	1	0	0	0	1	1
-29	1	0	0	0	1	0
-30	1	0	0	0	0	1
-31	1	0	0	0	0	0
-32	0	1	1	1	1	1
-33	0	1	1	1	1	0
-34	0	1	1	1	0	1
-35	0	1	1	1	0	0
-36	0	1	1	0	1	1
-37	0	1	1	0	1	0
-38	0	1	1	0	0	1
-39	0	1	1	0	0	0
-40	0	1	0	1	1	1
-41	0	1	0	1	1	0
-42	0	1	0	1	0	1
-43	0	1	0	1	0	0
-44	0	1	0	0	1	1
-45	0	1	0	0	1	0
-46	0	1	0	0	0	1
-47	0	1	0	0	0	0
-48	0	0	1	1	1	1
-49	0	0	1	1	1	0
-50	0	0	1	1	0	1
-51	0	0	1	1	0	0
-52	0	0	1	0	1	1
-53	0	0	1	0	1	0
-54	0	0	1	0	0	1
-55	0	0	1	0	0	0
-56	0	0	0	1	1	1
-58.5	0	0	0	1	1	0
-62	0	0	0	1	0	1
-68	0	0	0	1	0	0
Mute right rear	0	0	0	0	1	1
Mute right rear <sup>(1)</sup>	0	0	0	0	1	0
Mute right rear <sup>(1)</sup>	0	0	0	0	0	1
Mute right rear <sup>(1)</sup>	0	0	0	0	0	0

**Note**

1. Not tested; function not guaranteed.

Up-level Car radio Analog Signal Processor (CASP)

TEA6886HL

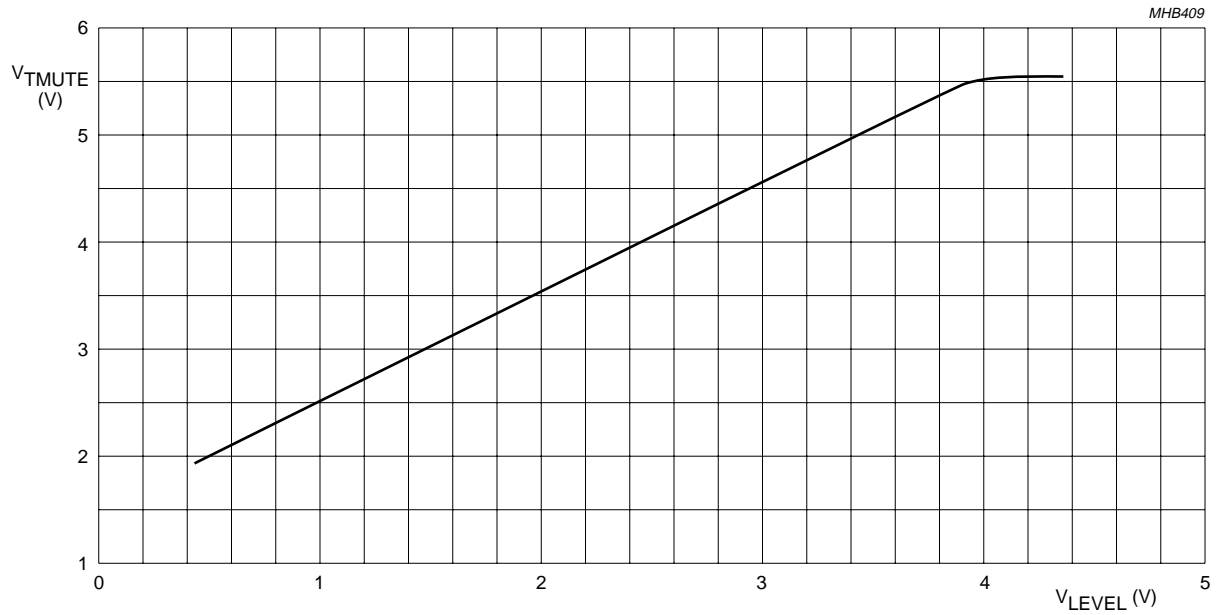

Fig.12 Muting average detector (TMUTE) dependency on level (LEVEL) and stereo noise control peak detector (TSNC) dependency on level (LEVEL).

Up-level Car radio Analog Signal Processor (CASP)

TEA6886HL

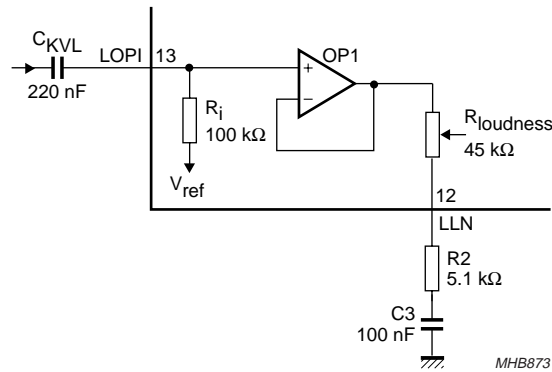

Fig.13 External circuit for loudness with bass boost only.

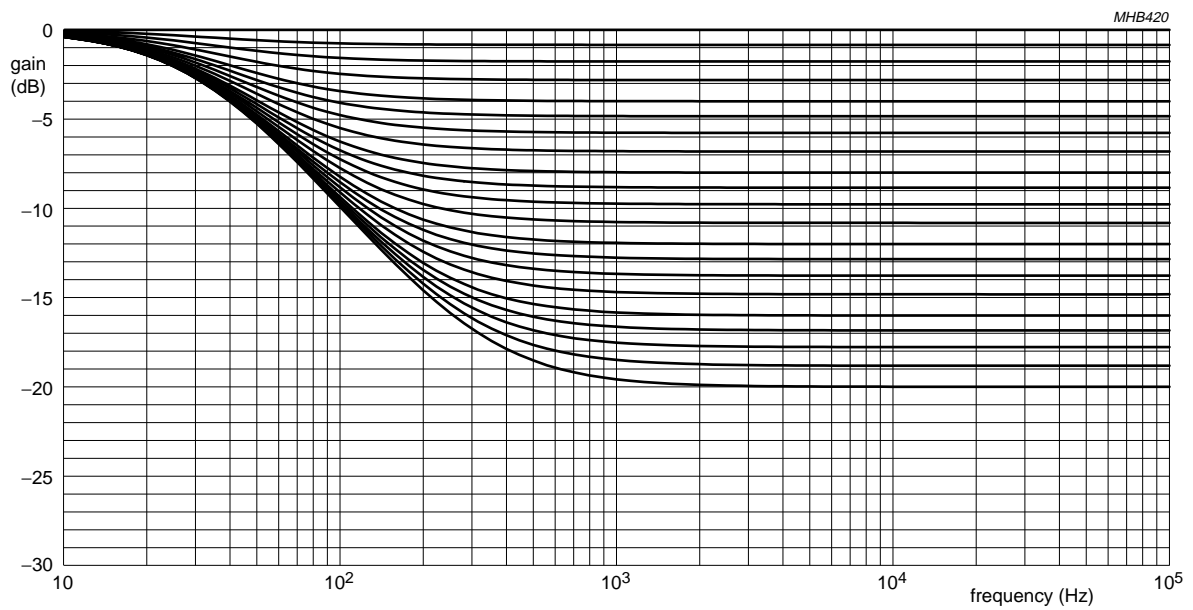

Fig.14 Loudness with bass boost only without influence of coupling capacitors  $C_{KVL}$  and  $C_{KVR}$ .

Up-level Car radio Analog Signal Processor (CASP)

TEA6886HL

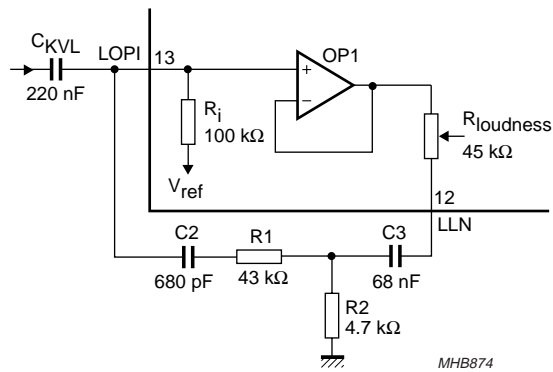

Fig.15 External circuit for loudness with bass and treble boost.

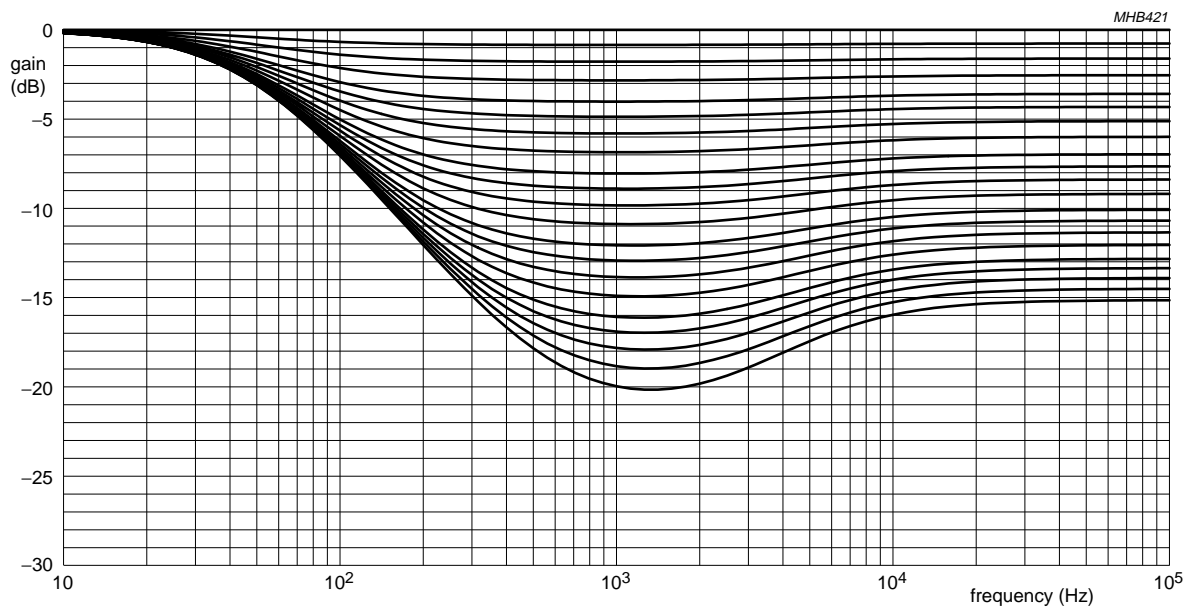

Fig.16 Loudness with bass and treble boost without influence of coupling capacitors CKVL and CKVR.

# Up-level Car radio Analog Signal Processor (CASP)

TEA6886HL

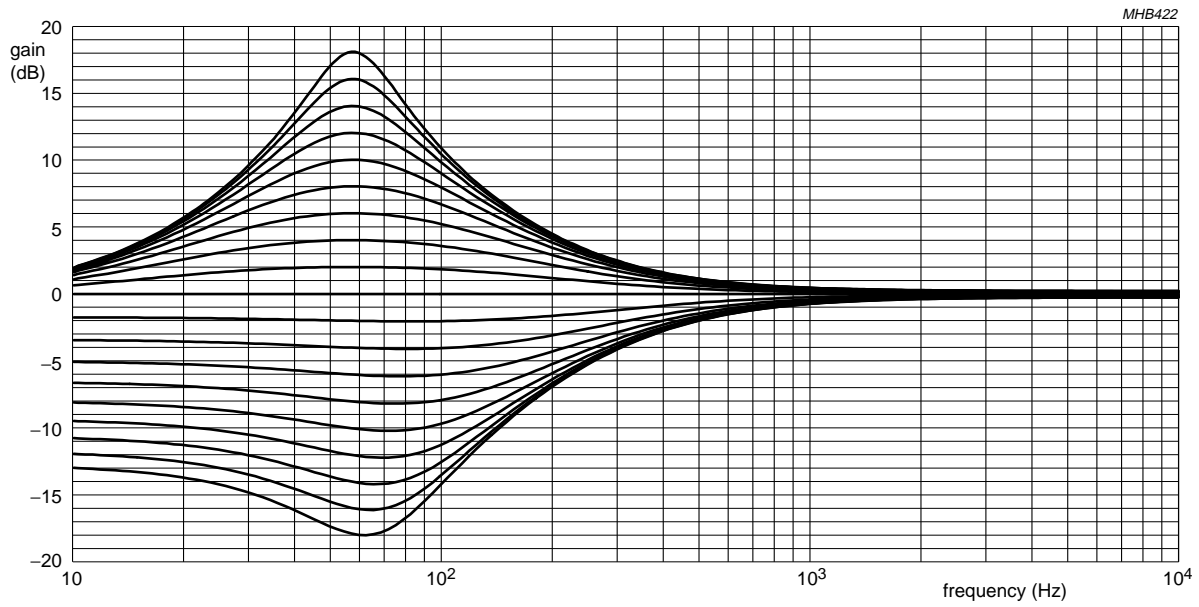

Fig.17 Bass curve with  $2 \times 220$  nF and  $R = 3.3$  k $\Omega$  external, BSYB = 1 for gain and BSYC = 0 for cut.

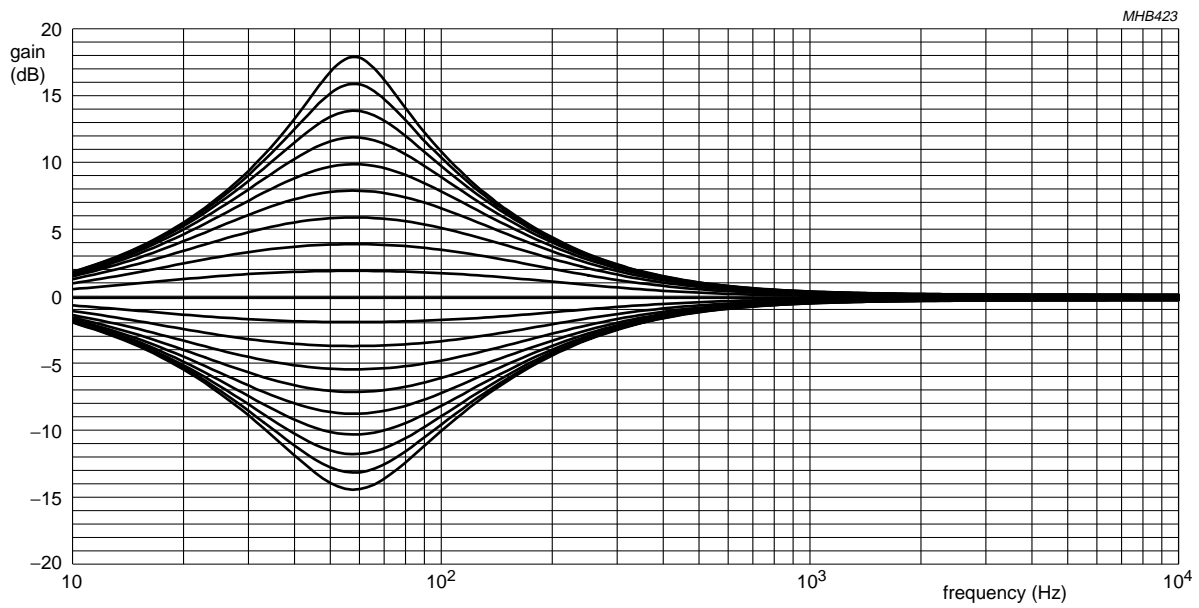

Fig.18 Bass curve with  $2 \times 220$  nF and  $R = 3.3$  k $\Omega$  external, BSYB = 1 and BSYC = 1.

# Up-level Car radio Analog Signal Processor (CASP)

## TEA6886HL

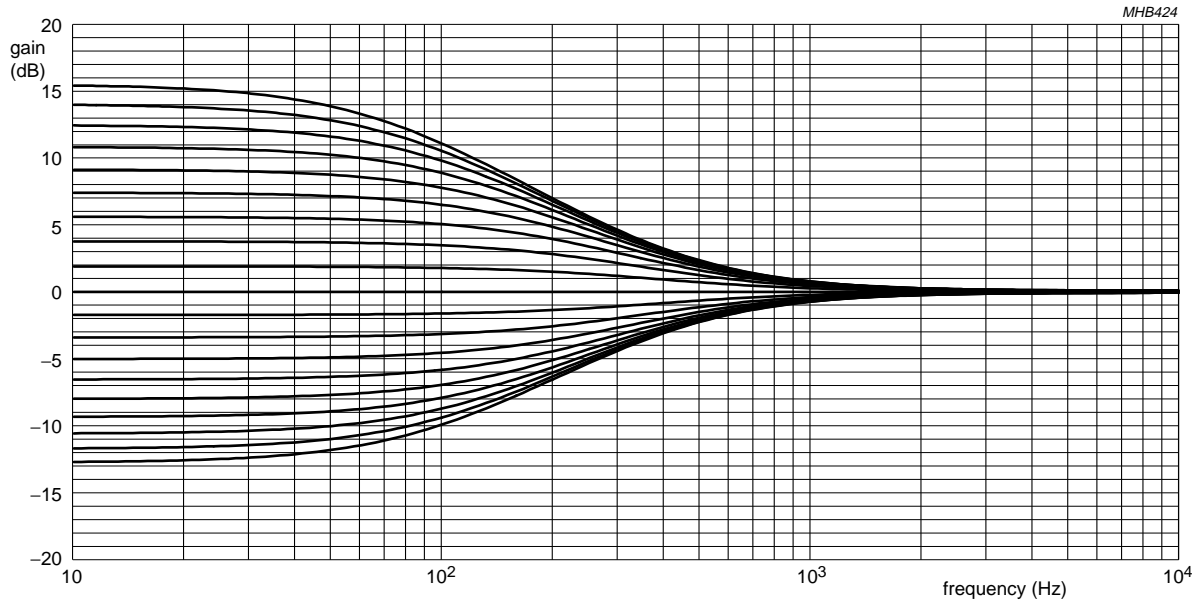

Fig.19 Bass curve with 1 × 47 nF external, between RBI and RBO, BSYB = 0 and BSYC = 0.

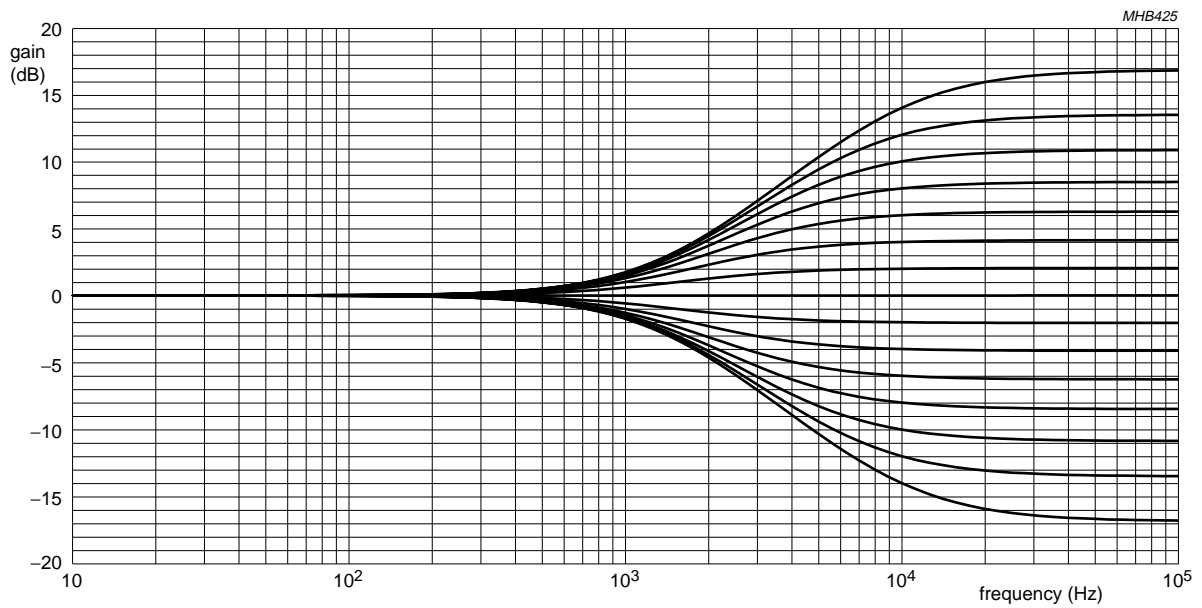

Fig.20 Treble control characteristic.

Up-level Car radio Analog Signal Processor (CASP)

TEA6886HL

12 INTERNAL CIRCUITRY

Table 62 Equivalent pin circuits

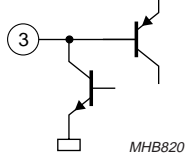
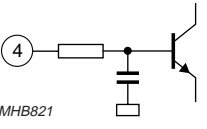
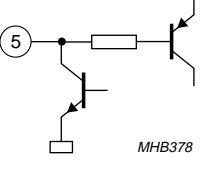
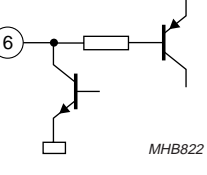
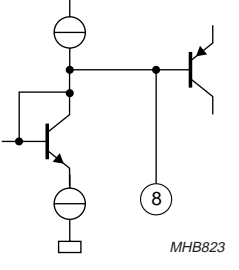
PIN	SYMBOL	EQUIVALENT CIRCUIT
1	n.c.	
2	n.c.	
3	SCLQ	
4	LEVEL	
5	SCL	
6	SDA	
7	DGND	
8	TBL	
9	V <sub>CC</sub>	



Up-level Car radio Analog Signal Processor (CASP)

TEA6886HL

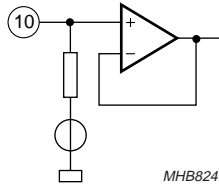
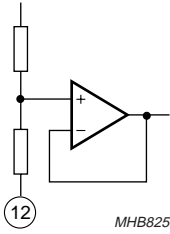
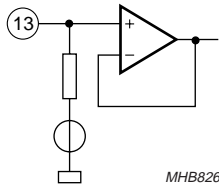
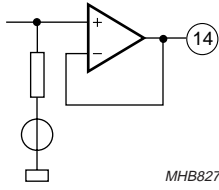
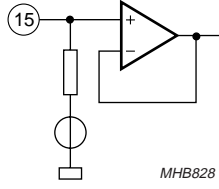
PIN	SYMBOL	EQUIVALENT CIRCUIT
10	CHIME	 <p>MHB824</p>
11	AGND	
12	LLN	 <p>MHB825</p>
13	LOPI	 <p>MHB826</p>
14	LOPO	 <p>MHB827</p>
15	BRI	 <p>MHB828</p>

Up-level Car radio Analog Signal Processor (CASP)

TEA6886HL

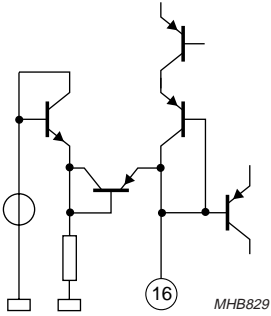
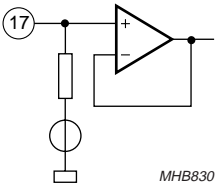
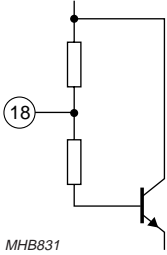
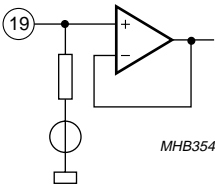
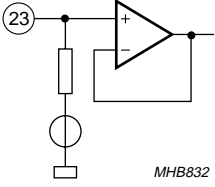
PIN	SYMBOL	EQUIVALENT CIRCUIT
16	ADR	 <p>MHB829</p>
17	BLI	 <p>MHB830</p>
18	SCAP	 <p>MHB831</p>
19	CRIP	 <p>MHB354</p>
20	n.c.	
21	n.c.	
22	n.c.	
23	CCOM	 <p>MHB832</p>

Up-level Car radio Analog Signal Processor (CASP)

TEA6886HL

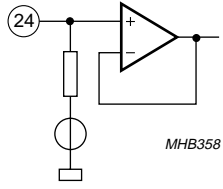
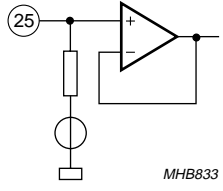
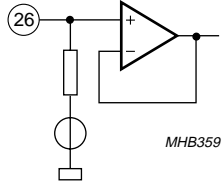
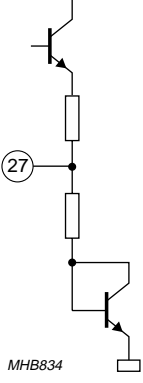
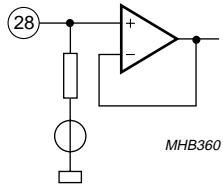
PIN	SYMBOL	EQUIVALENT CIRCUIT
24	CLIP	 <p>MHB358</p>
25	MONOC	 <p>MHB833</p>
26	MONOP	 <p>MHB359</p>
27	VHS	 <p>MHB834</p>
28	ARI	 <p>MHB360</p>

Up-level Car radio Analog Signal Processor (CASP)

TEA6886HL

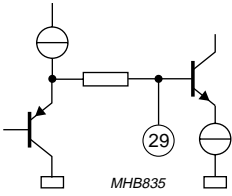
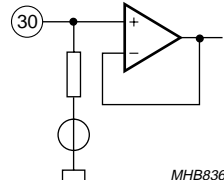
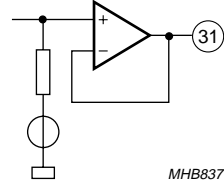
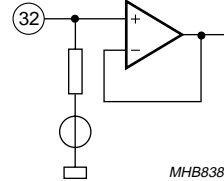
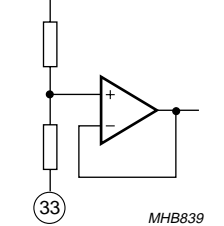
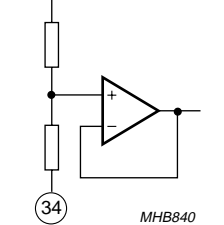
PIN	SYMBOL	EQUIVALENT CIRCUIT
29	AMNCAP	 <p>MHB835</p>
30	ALI	 <p>MHB836</p>
31	ROPO	 <p>MHB837</p>
32	ROPI	 <p>MHB838</p>
33	RLN	 <p>MHB839</p>
34	RTC	 <p>MHB840</p>

Up-level Car radio Analog Signal Processor (CASP)

TEA6886HL

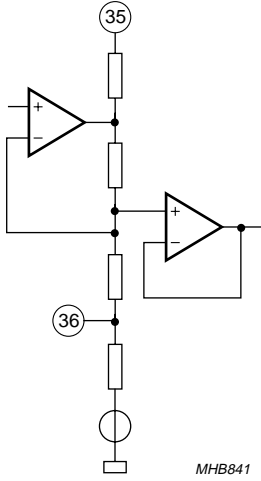
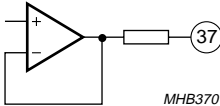
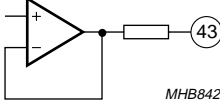
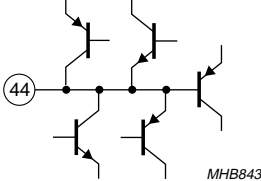
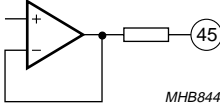
PIN	SYMBOL	EQUIVALENT CIRCUIT
35	RBI	
36	RBO	
37	RF	
38	n.c.	
39	n.c.	
40	n.c.	
41	n.c.	
42	n.c.	
43	RR	
44	ASICAP	
45	LR	

Up-level Car radio Analog Signal Processor (CASP)

TEA6886HL

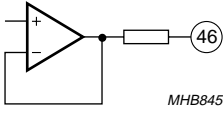
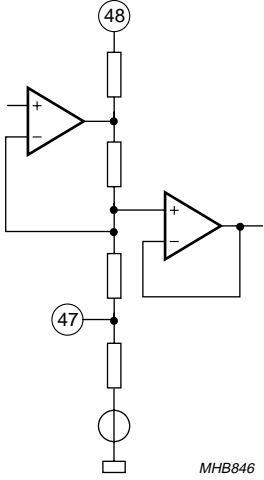
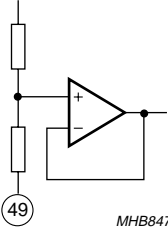
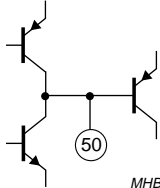
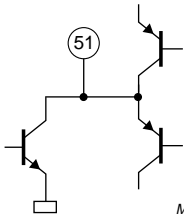
PIN	SYMBOL	EQUIVALENT CIRCUIT
46	LF	 <p>MHB845</p>
47	LBO	 <p>MHB846</p>
48	LBI	
49	LTC	 <p>MHB847</p>
50	AMPCAP	 <p>MHB848</p>
51	AMHOLD	 <p>MHB849</p>

Up-level Car radio Analog Signal Processor (CASP)

TEA6886HL

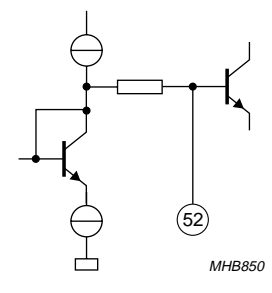
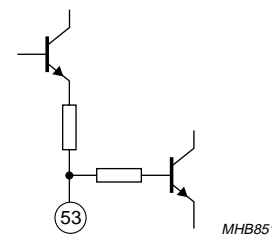
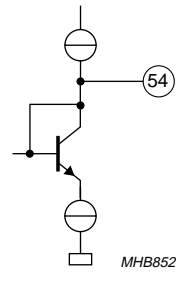
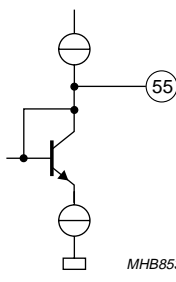
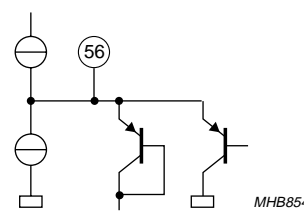
PIN	SYMBOL	EQUIVALENT CIRCUIT
52	AMHCAP	
53	IREF	
54	TWBAM2	
55	TUSN2	
56	PHASE	

Up-level Car radio Analog Signal Processor (CASP)

TEA6886HL

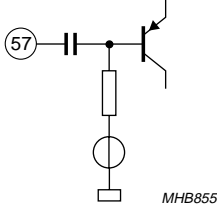
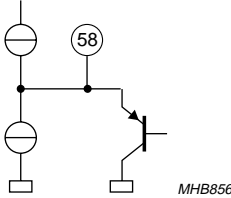
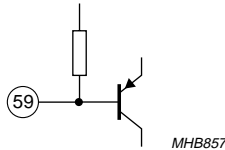
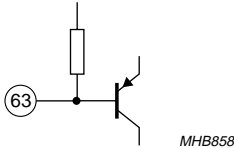
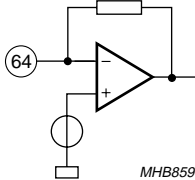
PIN	SYMBOL	EQUIVALENT CIRCUIT
57	FREF	 <p>MHB855</p>
58	PILOT	 <p>MHB856</p>
59	AFSAMPLE	 <p>MHB857</p>
60	n.c.	
61	n.c.	
62	n.c.	
63	FMHOLD	 <p>MHB858</p>
64	AMHIN	 <p>MHB859</p>



Up-level Car radio Analog Signal Processor (CASP)

TEA6886HL

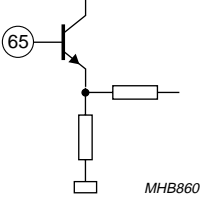
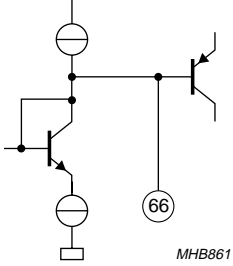
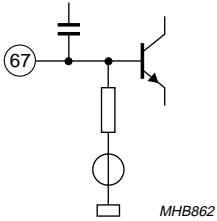
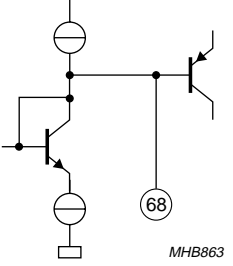
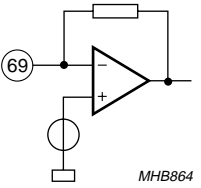
PIN	SYMBOL	EQUIVALENT CIRCUIT
65	AMNBIN	 <p>MHB860</p>
66	TMUTE	 <p>MHB861</p>
67	MPXRDS	 <p>MHB862</p>
68	TSNC	 <p>MHB863</p>
69	MPXIN	 <p>MHB864</p>

Up-level Car radio Analog Signal Processor (CASP)

TEA6886HL

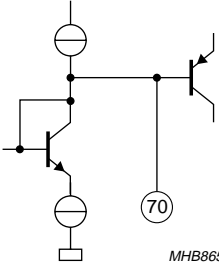
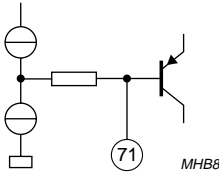
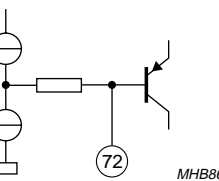
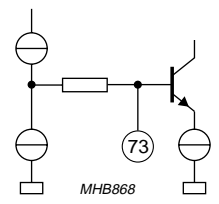
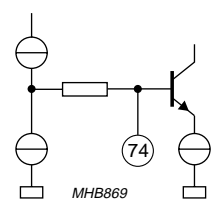
PIN	SYMBOL	EQUIVALENT CIRCUIT
70	FMNCAP	
71	DEEML	
72	DEEMR	
73	FMLBUF	
74	FMRBUF	

Up-level Car radio Analog Signal Processor (CASP)

TEA6886HL

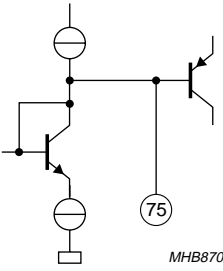
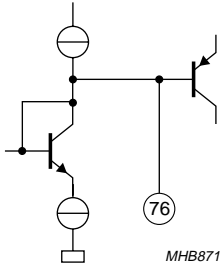
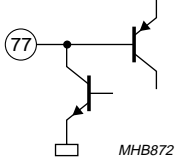
PIN	SYMBOL	EQUIVALENT CIRCUIT
75	TWBAM1	
76	TUSN1	
77	SDAQ	
78	n.c.	
79	n.c.	
80	n.c.	

# Up-level Car radio Analog Signal Processor (CASP)

## TEA6886HL

### 13 TEST CIRCUIT

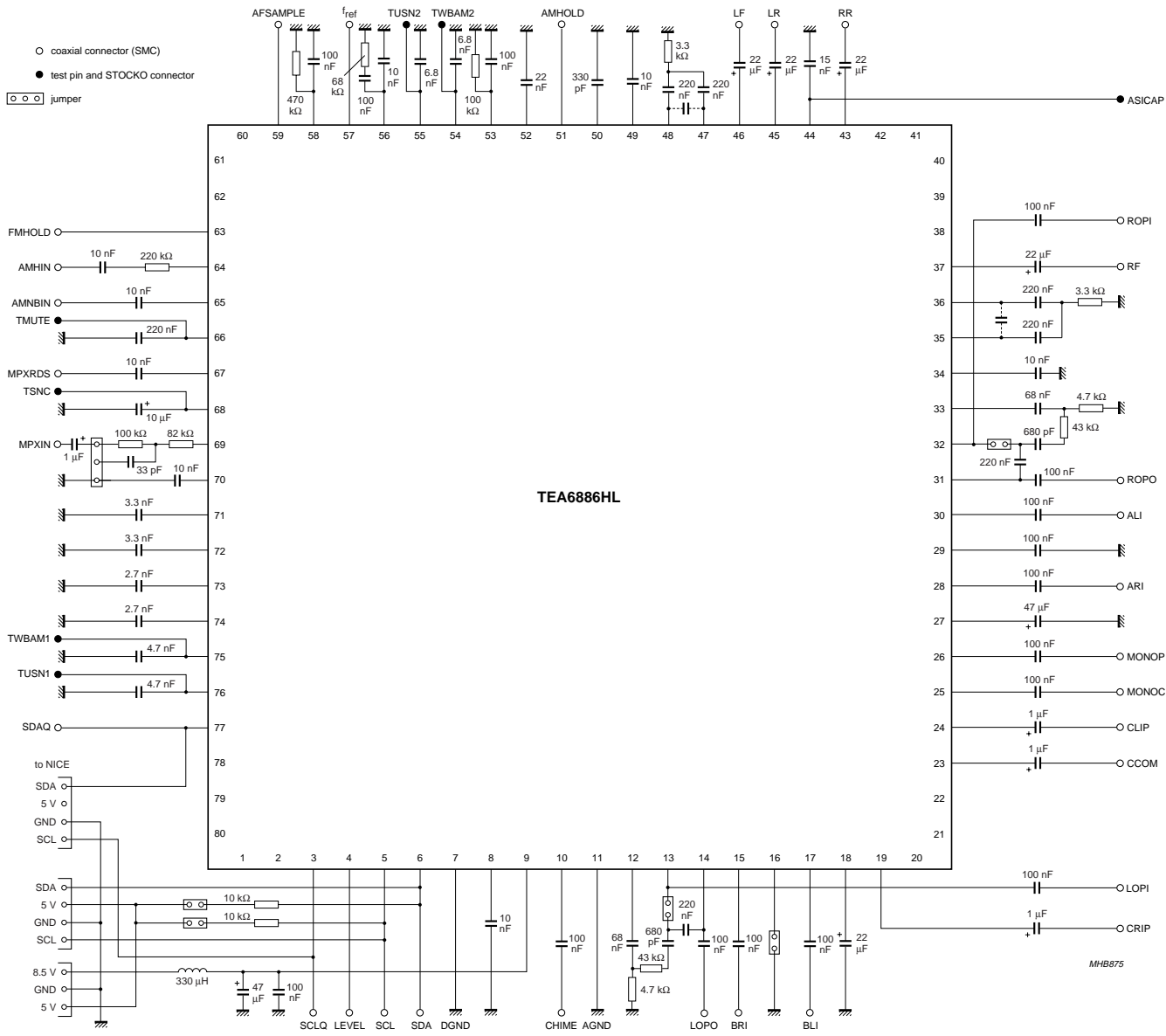

Fig.21 Test circuit.

# Up-level Car radio Analog Signal Processor (CASP)

## TEA6886HL

### 14 PACKAGE OUTLINE

LQFP80: plastic low profile quad flat package; 80 leads; body 12 x 12 x 1.4 mm

SOT315-1

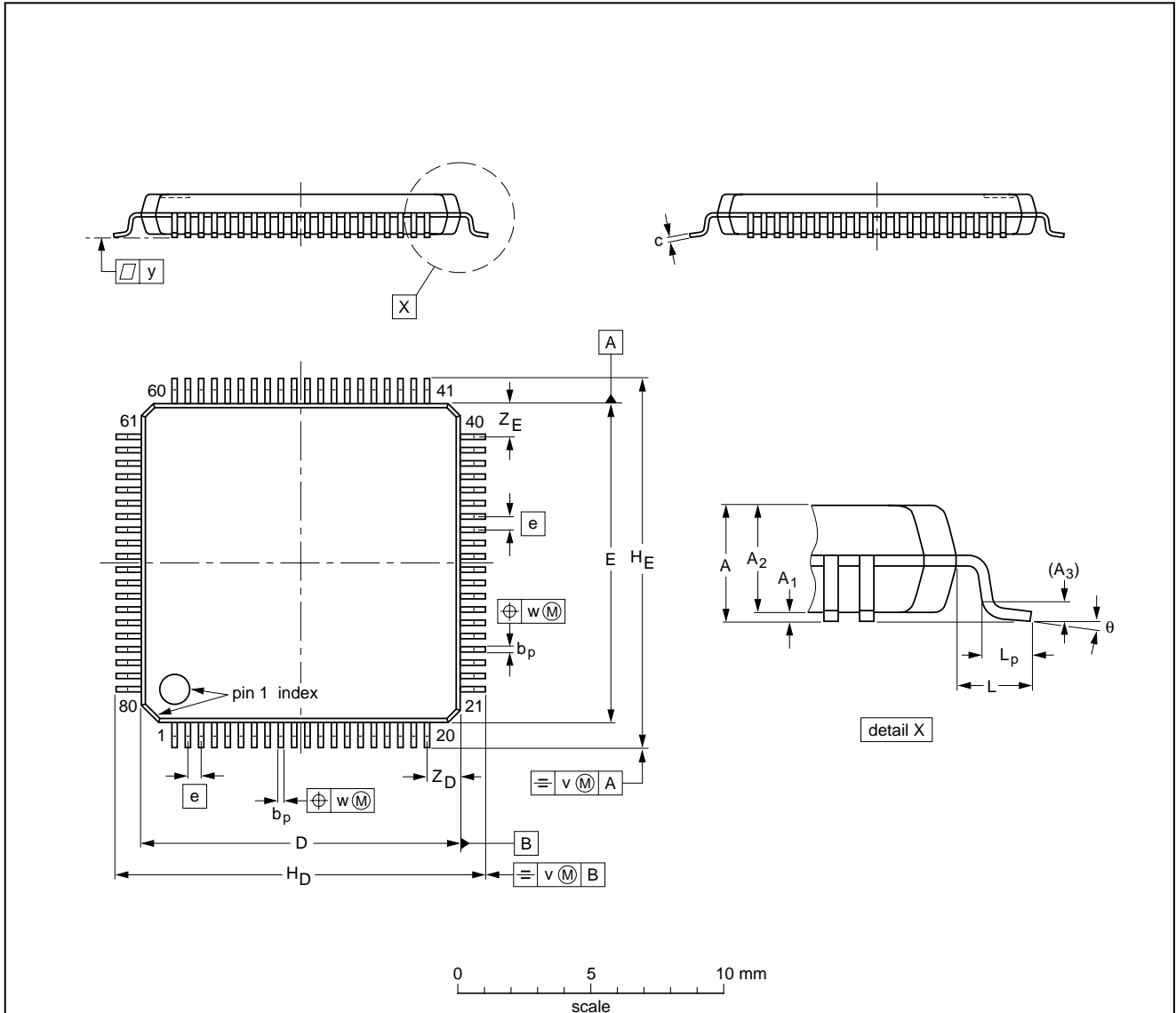

**DIMENSIONS (mm are the original dimensions)**

UNIT	A max.	A <sub>1</sub>	A <sub>2</sub>	A <sub>3</sub>	b <sub>p</sub>	c	D <sup>(1)</sup>	E <sup>(1)</sup>	e	H <sub>D</sub>	H <sub>E</sub>	L	L <sub>p</sub>	v	w	y	Z <sub>D</sub> <sup>(1)</sup>	Z <sub>E</sub> <sup>(1)</sup>	θ
mm	1.6	0.16 0.04	1.5 1.3	0.25	0.27 0.13	0.18 0.12	12.1 11.9	12.1 11.9	0.5	14.15 13.85	14.15 13.85	1.0	0.75 0.30	0.2	0.15	0.1	1.45 1.05	1.45 1.05	7° 0°

**Note**

1. Plastic or metal protrusions of 0.25 mm maximum per side are not included.

OUTLINE VERSION	REFERENCES				EUROPEAN PROJECTION	ISSUE DATE
	IEC	JEDEC	EIAJ			
SOT315-1	136E15	MS-026				99-12-27 00-01-19

## Up-level Car radio Analog Signal Processor (CASP)

TEA6886HL

### 15 SOLDERING

#### 15.1 Introduction to soldering surface mount packages

This text gives a very brief insight to a complex technology. A more in-depth account of soldering ICs can be found in our *"Data Handbook IC26; Integrated Circuit Packages"* (document order number 9398 652 90011).

There is no soldering method that is ideal for all surface mount IC packages. Wave soldering can still be used for certain surface mount ICs, but it is not suitable for fine pitch SMDs. In these situations reflow soldering is recommended.

#### 15.2 Reflow soldering

Reflow soldering requires solder paste (a suspension of fine solder particles, flux and binding agent) to be applied to the printed-circuit board by screen printing, stencilling or pressure-syringe dispensing before package placement.

Several methods exist for reflowing; for example, convection or convection/infrared heating in a conveyor type oven. Throughput times (preheating, soldering and cooling) vary between 100 and 200 seconds depending on heating method.

Typical reflow peak temperatures range from 215 to 250 °C. The top-surface temperature of the packages should preferably be kept below 220 °C for thick/large packages, and below 235 °C for small/thin packages.

#### 15.3 Wave soldering

Conventional single wave soldering is not recommended for surface mount devices (SMDs) or printed-circuit boards with a high component density, as solder bridging and non-wetting can present major problems.

To overcome these problems the double-wave soldering method was specifically developed.

If wave soldering is used the following conditions must be observed for optimal results:

- Use a double-wave soldering method comprising a turbulent wave with high upward pressure followed by a smooth laminar wave.
- For packages with leads on two sides and a pitch (e):
  - larger than or equal to 1.27 mm, the footprint longitudinal axis is **preferred** to be parallel to the transport direction of the printed-circuit board;
  - smaller than 1.27 mm, the footprint longitudinal axis **must** be parallel to the transport direction of the printed-circuit board.

The footprint must incorporate solder thieves at the downstream end.

- For packages with leads on four sides, the footprint must be placed at a 45° angle to the transport direction of the printed-circuit board. The footprint must incorporate solder thieves downstream and at the side corners.

During placement and before soldering, the package must be fixed with a droplet of adhesive. The adhesive can be applied by screen printing, pin transfer or syringe dispensing. The package can be soldered after the adhesive is cured.

Typical dwell time is 4 seconds at 250 °C.

A mildly-activated flux will eliminate the need for removal of corrosive residues in most applications.

#### 15.4 Manual soldering

Fix the component by first soldering two diagonally-opposite end leads. Use a low voltage (24 V or less) soldering iron applied to the flat part of the lead. Contact time must be limited to 10 seconds at up to 300 °C.

When using a dedicated tool, all other leads can be soldered in one operation within 2 to 5 seconds between 270 and 320 °C.

## Up-level Car radio Analog Signal Processor (CASP)

TEA6886HL

### 15.5 Suitability of surface mount IC packages for wave and reflow soldering methods

PACKAGE <sup>(1)</sup>	SOLDERING METHOD	
	WAVE	REFLOW <sup>(2)</sup>
BGA, LBGA, LFBGA, SQFP, TFBGA, VFBGA	not suitable	suitable
DHVQFN, HBCC, HBGA, HLQFP, HSQFP, HSOP, HTQFP, HTSSOP, HVQFN, HVSON, SMS	not suitable <sup>(3)</sup>	suitable
PLCC <sup>(4)</sup> , SO, SOJ	suitable	suitable
LQFP, QFP, TQFP	not recommended <sup>(4)(5)</sup>	suitable
SSOP, TSSOP, VSO	not recommended <sup>(6)</sup>	suitable

#### Notes

- For more detailed information on the BGA packages refer to the “(LF)BGA Application Note” (AN01026); order a copy from your Philips Semiconductors sales office.
- All surface mount (SMD) packages are moisture sensitive. Depending upon the moisture content, the maximum temperature (with respect to time) and body size of the package, there is a risk that internal or external package cracks may occur due to vaporization of the moisture in them (the so called popcorn effect). For details, refer to the Drypack information in the “Data Handbook IC26; Integrated Circuit Packages; Section: Packing Methods”.
- These packages are not suitable for wave soldering. On versions with the heatsink on the bottom side, the solder cannot penetrate between the printed-circuit board and the heatsink. On versions with the heatsink on the top side, the solder might be deposited on the heatsink surface.
- If wave soldering is considered, then the package must be placed at a 45° angle to the solder wave direction. The package footprint must incorporate solder thieves downstream and at the side corners.
- Wave soldering is suitable for LQFP, TQFP and QFP packages with a pitch (e) larger than 0.8 mm; it is definitely not suitable for packages with a pitch (e) equal to or smaller than 0.65 mm.
- Wave soldering is suitable for SSOP and TSSOP packages with a pitch (e) equal to or larger than 0.65 mm; it is definitely not suitable for packages with a pitch (e) equal to or smaller than 0.5 mm.

# Up-level Car radio Analog Signal Processor (CASP)

TEA6886HL

## 16 DATA SHEET STATUS

LEVEL	DATA SHEET STATUS <sup>(1)</sup>	PRODUCT STATUS <sup>(2)(3)</sup>	DEFINITION
I	Objective data	Development	This data sheet contains data from the objective specification for product development. Philips Semiconductors reserves the right to change the specification in any manner without notice.
II	Preliminary data	Qualification	This data sheet contains data from the preliminary specification. Supplementary data will be published at a later date. Philips Semiconductors reserves the right to change the specification without notice, in order to improve the design and supply the best possible product.
III	Product data	Production	This data sheet contains data from the product specification. Philips Semiconductors reserves the right to make changes at any time in order to improve the design, manufacturing and supply. Relevant changes will be communicated via a Customer Product/Process Change Notification (CPCN).

### Notes

1. Please consult the most recently issued data sheet before initiating or completing a design.
2. The product status of the device(s) described in this data sheet may have changed since this data sheet was published. The latest information is available on the Internet at URL <http://www.semiconductors.philips.com>.
3. For data sheets describing multiple type numbers, the highest-level product status determines the data sheet status.

## 17 DEFINITIONS

**Short-form specification** — The data in a short-form specification is extracted from a full data sheet with the same type number and title. For detailed information see the relevant data sheet or data handbook.

**Limiting values definition** — Limiting values given are in accordance with the Absolute Maximum Rating System (IEC 60134). Stress above one or more of the limiting values may cause permanent damage to the device. These are stress ratings only and operation of the device at these or at any other conditions above those given in the Characteristics sections of the specification is not implied. Exposure to limiting values for extended periods may affect device reliability.

**Application information** — Applications that are described herein for any of these products are for illustrative purposes only. Philips Semiconductors make no representation or warranty that such applications will be suitable for the specified use without further testing or modification.

## 18 DISCLAIMERS

**Life support applications** — These products are not designed for use in life support appliances, devices, or systems where malfunction of these products can reasonably be expected to result in personal injury. Philips Semiconductors customers using or selling these products for use in such applications do so at their own risk and agree to fully indemnify Philips Semiconductors for any damages resulting from such application.

**Right to make changes** — Philips Semiconductors reserves the right to make changes in the products - including circuits, standard cells, and/or software - described or contained herein in order to improve design and/or performance. When the product is in full production (status 'Production'), relevant changes will be communicated via a Customer Product/Process Change Notification (CPCN). Philips Semiconductors assumes no responsibility or liability for the use of any of these products, conveys no licence or title under any patent, copyright, or mask work right to these products, and makes no representations or warranties that these products are free from patent, copyright, or mask work right infringement, unless otherwise specified.



---

**Up-level Car radio Analog Signal  
Processor (CASP)**

---

**TEA6886HL****19 PURCHASE OF PHILIPS I<sup>2</sup>C COMPONENTS**

Purchase of Philips I<sup>2</sup>C components conveys a license under the Philips' I<sup>2</sup>C patent to use the components in the I<sup>2</sup>C system provided the system conforms to the I<sup>2</sup>C specification defined by Philips. This specification can be ordered using the code 9398 393 40011.

---

Up-level Car radio Analog Signal  
Processor (CASP)

---

TEA6886HL

**NOTES**

---

Up-level Car radio Analog Signal  
Processor (CASP)

---

TEA6886HL

**NOTES**

# *Philips Semiconductors – a worldwide company*

## **Contact information**

For additional information please visit <http://www.semiconductors.philips.com>. Fax: +31 40 27 24825

For sales offices addresses send e-mail to: [sales.addresses@www.semiconductors.philips.com](mailto:sales.addresses@www.semiconductors.philips.com).

© Koninklijke Philips Electronics N.V. 2003

SCA75

All rights are reserved. Reproduction in whole or in part is prohibited without the prior written consent of the copyright owner.

The information presented in this document does not form part of any quotation or contract, is believed to be accurate and reliable and may be changed without notice. No liability will be accepted by the publisher for any consequence of its use. Publication thereof does not convey nor imply any license under patent- or other industrial or intellectual property rights.

Printed in The Netherlands

753503/02/pp92

Date of release: 2003 Feb 04

Document order number: 9397 750 10542

*Let's make things better.*

**Philips  
Semiconductors**



**PHILIPS**