maXTouch 448-node Touchscreen Controller

Functional Safety

- UL/IEC 60730 Class B support
- Self diagnostics at power-on and as periodic tests during operation
- Heartbeat (alive) signal output to host

maXTouch[®] Adaptive Sensing Technology

- Up to 32 X (transmit) lines and 20 Y (receive) lines for use by a touchscreen and/or key array (see [Section 4.3 “Permitted Configurations”](#))
- A maximum of 448 nodes can be allocated to the touch sensor
- Touchscreen size of 8.3 inches (16:9 aspect ratio), assuming a sensor electrode pitch of 6.5 mm. Other sizes are possible with different electrode pitches and appropriate sensor material
- Multiple touch support with up to 16 concurrent touches tracked in real time

Keys

- Up to 32 nodes can be allocated as mutual capacitance sensor keys in addition to the touchscreen, defined as 1 key array (subject to availability of X and Y lines and other configurations)
- Support for up to 3 mutual capacitance Generic Keys as an alternative to the touchscreen key array (subject to other configurations)
- Adjacent Key Suppression (AKS) technology is supported for false key touch prevention

Touch Sensor Technology

- Discrete/out-cell support including glass and PET film-based sensors
- On-cell/touch-on display support including TFT, LCD (ITPS, IPS) and OLED
- Synchronization with display refresh timing capability
- Support for standard (for example, Diamond) and proprietary sensor patterns (review of designs by Microchip or a Microchip-qualified touch sensor module partner is recommended)

Front Panel Material and Design

- Works with PET or glass, including curved profiles (configuration and stack-up to be approved by Microchip or a Microchip-qualified touch sensor module partner)

- 10 mm glass (or 5 mm PMMA) with bare finger (dependent on sensor size, touch size, configuration and stack-up)
- 6 mm glass (or 3 mm PMMA) with multi-finger 5 mm glove (2.7 mm PMMA equivalent) (dependent on sensor size, touch size, configuration and stack-up)
- Support for non-rectangular sensor designs (for example, circular, rounded or with cutouts)

Touch Performance

- Moisture/Water Compensation
 - No false touch with condensation or water drop up to 22 mm diameter
 - One-finger tracking with condensation or water drop up to 22 mm diameter
- Mutual capacitance and self capacitance measurements supported for robust touch detection
- P2P mutual capacitance measurements supported for extra sensitive multi-touch sensing
- Noise suppression technology to combat ambient and power-line noise
 - Up to 240 V_{PP} between 1 Hz and 1 kHz sinusoidal waveform (no touches)
 - IEC 61000-4-6, 10 V_{rms}, Class A (normal touch operation) conducted noise immunity
- Stylus Support
 - Supports passive stylus with 1.5 mm contact diameter, subject to configuration, stack-up, and sensor design
- Burst Frequency
 - Flexible and dynamic Tx burst frequency selection to reduce EMC disturbance
 - Configurable Tx waveform shaping to reduce emissions
- Scan Speed
 - Typical report rate for 10 touches ≥ 90 Hz (subject to configuration)
 - Initial touch latency <25 ms for first touch from idle (subject to configuration)
 - Configurable to allow for power and speed optimization

On-chip Gestures

- Reports one-touch and two-touch gestures

mXT448UD-CCUBHA1 1.0

Enhanced Algorithms

- Lens bending algorithms to remove display noise
- Touch suppression algorithms to remove unintentional large touches, such as palm
- Palm Recovery Algorithm for quick restoration to normal state

Data Store

- Up to 64 bytes of user's custom data (not CRC checksummed)

Power Saving

- Programmable timeout for automatic transition from Active to Idle state
- Pipelined analog sensing detection and digital processing to optimize system power efficiency

Application Interfaces

- I²C client interface for main communication with the device, with support for Standard mode (up to 100 kHz), Fast mode (up to 400 kHz), Fast-mode Plus (up to 1 MHz), High Speed mode (up to 3.4 MHz)
- Optional secondary SPI interface for separate messaging (up to 8 MHz)
- Two separate interrupts to indicate when messages are available on the corresponding interfaces
- Additional Hardware Debug Interface to read the raw data for tuning and debugging purposes

Power Supply

- Digital (V_{dd}) 3.3V nominal
- Digital I/O (V_{ddIO}) 3.3V nominal
- Analog (AV_{dd}) 3.3V nominal
- High voltage internal X line drive (XV_{dd}) 6.6V or 9.9V with internal voltage pump

Package

- 88-ball UFBGA 6 × 6 × 0.6 mm, 0.5 mm pitch

Operating Temperature

- -40°C to +105°C

Design Services

- Review of device configuration, stack-up and sensor patterns

PIN CONFIGURATION

88-ball UFBGA

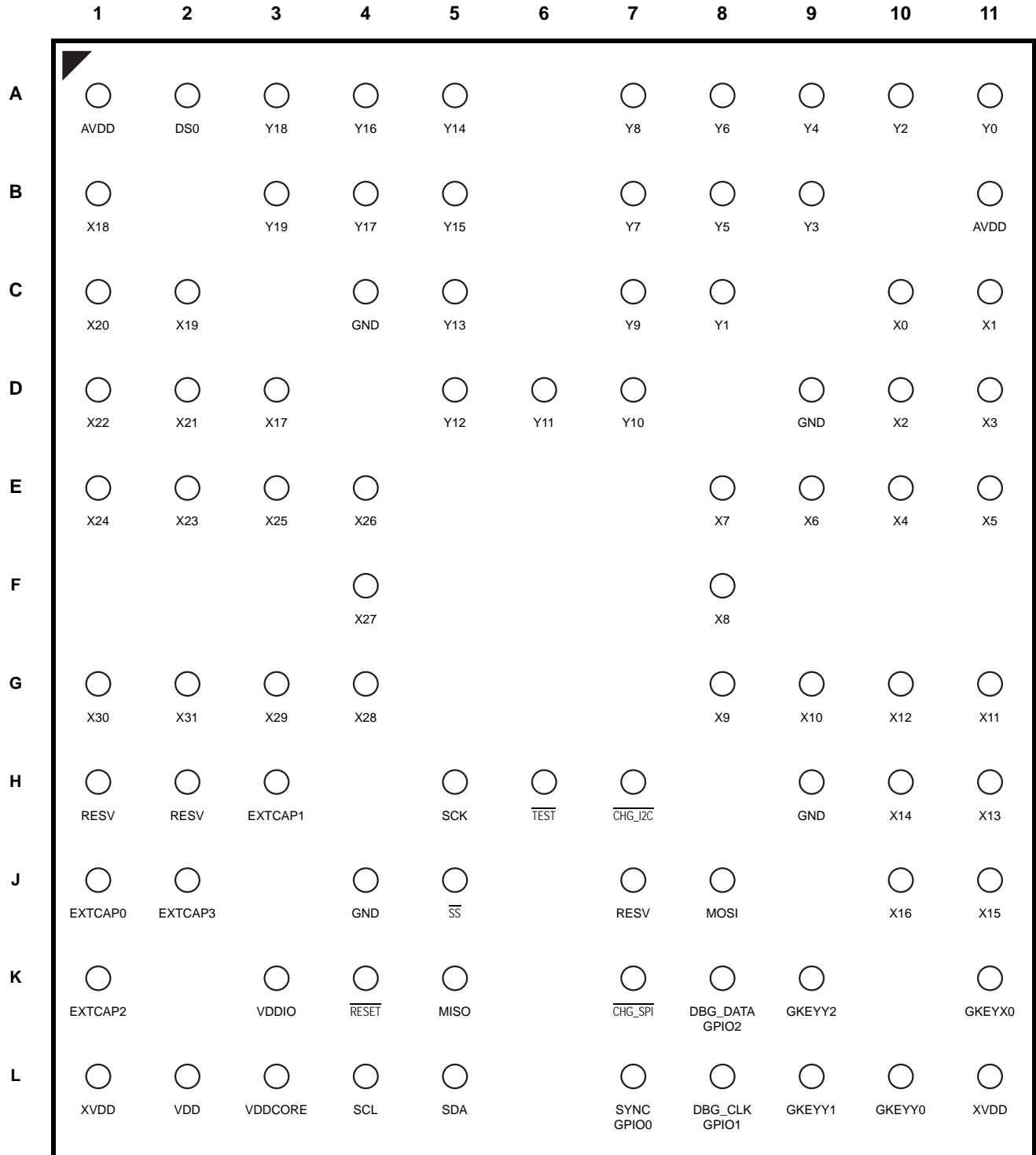

Top View

mXT448UD-CCUBHA1 1.0

TABLE 1: PIN LISTING – 88-BALL UFBGA

Ball	Name	Type	Supply	Comments	If Unused...
A1	AVDD	P	–	Analog power	–
A2	DS0	S	AVdd	Driven Shield signal; used as guard track between X/Y signals and ground	Leave open
A3	Y18	S	AVdd	Y line connection	Leave open
A4	Y16	S	AVdd	Y line connection	Leave open
A5	Y14	S	AVdd	Y line connection	Leave open
–					
A7	Y8	S	AVdd	Y line connection	Leave open
A8	Y6	S	AVdd	Y line connection	Leave open
A9	Y4	S	AVdd	Y line connection	Leave open
A10	Y2	S	AVdd	Y line connection	Leave open
A11	Y0	S	AVdd	Y line connection	Leave open
B1	X18	S	XVdd	X line connection	Leave open
–					
B3	Y19	S	AVdd	Y line connection	Leave open
B4	Y17	S	AVdd	Y line connection	Leave open
B5	Y15	S	AVdd	Y line connection	Leave open
–					
B7	Y7	S	AVdd	Y line connection	Leave open
B8	Y5	S	AVdd	Y line connection	Leave open
B9	Y3	S	AVdd	Y line connection	Leave open
–					
B11	AVDD	P	–	Analog power	–
C1	X20	S	XVdd	X line connection	Leave open
C2	X19	S	XVdd	X line connection	Leave open
–					
C4	GND	P	–	Ground	–
C5	Y13	S	AVdd	Y line connection	Leave open
–					
C7	Y9	S	AVdd	Y line connection	Leave open
C8	Y1	S	AVdd	Y line connection	Leave open
–					
C10	X0	S	XVdd	X line connection	Leave open
C11	X1	S	XVdd	X line connection	Leave open
D1	X22	S	XVdd	X line connection	Leave open
D2	X21	S	XVdd	X line connection	Leave open
D3	X17	S	XVdd	X line connection	Leave open
–					
D5	Y12	S	AVdd	Y line connection	Leave open
D6	Y11	S	AVdd	Y line connection	Leave open
–					
D7	Y10	S	AVdd	Y line connection	Leave open

TABLE 1: PIN LISTING – 88-BALL UFBGA (CONTINUED)

Ball	Name	Type	Supply	Comments	If Unused...
–					
D9	GND	P	–	Ground	–
D10	X2	S	XVdd	X line connection	Leave open
D11	X3	S	XVdd	X line connection	Leave open
E1	X24	S	XVdd	X line connection	Leave open
E2	X23	S	XVdd	X line connection	Leave open
E3	X25	S	XVdd	X line connection	Leave open
E4	X26	S	XVdd	X line connection	Leave open
–					
E8	X7	S	XVdd	X line connection	Leave open
E9	X6	S	XVdd	X line connection	Leave open
E10	X4	S	XVdd	X line connection	Leave open
E11	X5	S	XVdd	X line connection	Leave open
–					
F4	X27	S	XVdd	X line connection	Leave open
F8	X8	S	XVdd	X line connection	Leave open
G1	X30	S	XVdd	X line connection	Leave open
G2	X31	S	XVdd	X line connection	Leave open
G3	X29	S	XVdd	X line connection	Leave open
G4	X28	S	XVdd	X line connection	Leave open
–					
G8	X9	S	XVdd	X line connection	Leave open
G9	X10	S	XVdd	X line connection	Leave open
G10	X12	S	XVdd	X line connection	Leave open
G11	X11	S	XVdd	X line connection	Leave open
H1	RESV	S	–	Reserved for future use	Leave open
H2	RESV	S	–	Reserved for future use	Leave open
H3	EXTCAP1	P	–	Connect to EXTCAP2 via capacitor; see Section 2.2 “Schematic Notes”	–
–					
H5	SCK	I	VddIO	SPI Secondary Interface: Serial Clock	Pullup to VddIO
H6	$\overline{\text{TEST}}$	–	VddIO	Reserved for factory use. Pull up to VDDIO	–
–					
H7	$\overline{\text{CHG_I2C}}$	OD	VddIO	I ² C Primary Interface: State change interrupt. Pull up to VddIO	–
–					
H9	GND	P	–	Ground	–
H10	X14	S	XVdd	X line connection	Leave open
H11	X13	S	XVdd	X line connection	Leave open
J1	EXTCAP0	P	–	Connect to EXTCAP3 via capacitor; see Section 2.2 “Schematic Notes”	Leave open
J2	EXTCAP3	P	–	Connect to EXTCAP0 via capacitor; see Section 2.2 “Schematic Notes”	Leave open
–					

mXT448UD-CCUBHA1 1.0

TABLE 1: PIN LISTING – 88-BALL UFBGA (CONTINUED)

Ball	Name	Type	Supply	Comments	If Unused...
J4	GND	P	–	Ground	–
J5	\overline{SS}	I	VddIO	SPI Secondary Interface: Serial Select (active low)	Pull up to VddIO
–					
J7	RESV	I	VddIO	Reserved for future use; connect to GND	–
J8	MOSI	I	VddIO	SPI Secondary Interface: Serial Data – Host Output Client Input	Pull up to VddIO
–					
J10	X16	S	XVdd	X line connection	Leave open
J11	X15	S	XVdd	X line connection	Leave open
K1	EXTCAP2	P	VddIO	Connect to EXTCAP1 via capacitor; see Section 2.2 “Schematic Notes”	–
–					
K3	VDDIO	P	–	Digital IO interface power	–
K4	\overline{RESET}	I	VddIO	Connection to host system is recommended	Pull up to VDDIO
K5	MISO	O	VddIO	SPI Secondary Interface: Serial Data – Host Input Client Output	Leave open
–					
K7	$\overline{CHG_SPI}$	OD	VddIO	Secondary Interface: State change interrupt. Pull up to VddIO	Pull up to VddIO
K8	DBG_DATA	O	VddIO	Debug Data. Connect to test point; see Section 2.2.11 “Hardware Debug Interface”	Connect to test point
	GPIO2	I/O	VddIO	General purpose I/O; see Section 2.2.10 “GPIO Pins”	
K9	GKEYY2	S	AVdd	GKey Y line connection	Leave open
–					
K11	GKEYX0	S	XVdd	GKey X line connection	Leave open
L1	XVDD	P	–	X line drive power	–
L2	VDD	P	–	Digital Power	–
L3	VDDCORE	P	–	Digital core power	–
L4	SCL	OD	VddIO	I ² C Primary Interface: Serial Interface Clock	–
L5	SDA	OD	VddIO	I ² C Primary Interface: Serial Interface Data	–
–					
L7	SYNC	I	VddIO	Measurement synchronization input	Connect to test point
	GPIO0	I/O		General purpose I/O; see Section 2.2.10 “GPIO Pins”	
L8	DBG_CLK	O	VddIO	Debug Clock. Connect to test point; see Section 2.2.11 “Hardware Debug Interface”	Connect to test point
	GPIO1	I/O		General purpose I/O; see Section 2.2.10 “GPIO Pins”	
L9	GKEYY1	S	AVdd	GKey Y line connection	Leave open
L10	GKEYY0	S	AVdd	GKey Y line connection	Leave open
L11	XVDD	P	–	X line drive power	–

Key:

I	Input only	O	Output only	I/O	Input or output
OD	Open drain output	P	Ground or power	S	Sense pin

TABLE OF CONTENTS

Pin configuration	3
Table of Contents	7
To Our Valued Customers	8
1.0 Overview of mXT448UD-CCUBHA1	9
2.0 Schematics	10
3.0 Touchscreen Basics	13
4.0 Sensor Layout	14
5.0 Power-up / Reset Requirements	17
6.0 Detailed Operation	20
7.0 Host Communications	24
8.0 I2C Communications	25
9.0 SPI Communications	31
10.0 PCB Design Considerations	40
11.0 Getting Started with mXT448UD-CCUBHA1	45
12.0 Debugging and Tuning	50
13.0 Specifications	52
14.0 Packaging Information	65
Appendix A. Associated Documents	69
Appendix B. Revision History	70
Index	71
Product Identification System	73
The Microchip Web Site	74
The maXTouch web site	74
Customer Change Notification Service	74
Customer Support	74

TO OUR VALUED CUSTOMERS

It is our intention to provide our valued customers with the best documentation possible to ensure successful use of your Microchip products. To this end, we will continue to improve our publications to better suit your needs. Our publications will be refined and enhanced as new volumes and updates are introduced.

If you have any questions or comments regarding this publication, please contact the Marketing Communications Department via E-mail at docerrors@microchip.com. We welcome your feedback.

Most Current Data Sheet

To obtain the most up-to-date version of this data sheet, please register at our Worldwide Web site at:

<http://www.microchip.com>

You can determine the version of a data sheet by examining its literature number found on the bottom outside corner of any page. The last character of the literature number is the version number, (for example, DS30000000A is version A of document DS30000000).

Errata

An errata sheet, describing minor operational differences from the data sheet and recommended workarounds, may exist for current devices. As device/documentation issues become known to us, we will publish an errata sheet. The errata will specify the revision of silicon and revision of document to which it applies.

To determine if an errata sheet exists for a particular device, please check with one of the following:

- Microchip's Worldwide Web site; <http://www.microchip.com>
- Your local Microchip sales office (see last page)

When contacting Microchip, please specify which device, revision of silicon and data sheet (include literature number) you are using.

Customer Notification System

Register on our web site at <http://www.microchip.com> to receive the most current information on all of our products.

1.0 OVERVIEW OF MXT448UD-CCUBHA1

The Microchip maXTouch family of touch controllers brings industry-leading capacitive touch performance to customer applications. The mXT448UD-CCUBHA1 features the latest generation of Microchip adaptive sensing technology that utilizes a hybrid mutual and self capacitive sensing system in order to deliver unparalleled touch features and a robust user experience.

- **Functional Safety** – The device is designed with functional safety applications in mind (for example, for the home appliance market). Specifically, the device complies with the UL/IEC 60730 Class B safety specifications. See [Section 6.7 “Functional Safety – UL/IEC 60730 Class B Compliance”](#) for more information.
- **Patented capacitive sensing method** – The mXT448UD-CCUBHA1 uses a unique charge-transfer acquisition engine to implement Microchip's patented capacitive sensing method. Coupled with a state-of-the-art CPU, the entire touchscreen sensing solution can measure, classify and track a number of individual finger touches with a high degree of accuracy in the shortest response time.
- **Capacitive Touch Engine (CTE)** – The mXT448UD-CCUBHA1 features an acquisition engine that uses an optimal measurement approach to ensure almost complete immunity from parasitic capacitance on the receiver input lines. The engine includes sufficient dynamic range to cope with anticipated touchscreen self and mutual capacitances, which allows great flexibility for use with the Microchip proprietary sensor pattern designs. One- and two-layer ITO sensors are possible using glass or PET substrates.
- **Touch detection** – The mXT448UD-CCUBHA1 allows for both mutual and self capacitance measurements, with the self capacitance measurements being used to augment the mutual capacitance measurements to produce reliable touch information.

When self capacitance measurements are enabled, touch classification is achieved using both mutual and self capacitance touch data. This has the advantage that both types of measurement systems can work together to detect touches under a wide variety of circumstances.

The system may be configured for different types of default measurements in both idle and active modes. For example, the device may be configured for Mutual Capacitance Touch as the default in active mode and Self Capacitance Touch as the default in idle mode. Note that other types of scans (such as P2P mutual capacitance scans and other types of self capacitance scans) may also be made depending on configuration.

Mutual capacitance touch data is used wherever possible to classify touches as this has a greater resolution than self capacitance measurements and provides positional information on touches. For this reason, multiple touches can only be determined by mutual capacitance touch data. In Self Capacitance Touch Default mode, if the self capacitance touch processing detects multiple touches, touchscreen processing is skipped until mutual capacitance touch data is available.

Self capacitance and P2P mutual capacitance measurements allow for the detection of touches in extreme scenarios, such as thick glove touches, when mutual capacitance touch detection alone may miss touches.

- **Display Noise Cancellation** – A combination of analog circuitry, hardware noise processing, and firmware combats display noise without requiring additional listening channels or synchronization to display timing. This enables the use of shieldless touch sensor stacks, including touch-on-lens.
- **Noise filtering** – Hardware noise processing in the capacitive touch engine provides enhanced autonomous filtering and allows a broad range of noise profiles to be handled. The result is good performance in the presence of LCD noise.
- **Processing power** – The main CPU has two companion microsequencer coprocessors under its control consuming low power. This system allows the signal acquisition, preprocessing and postprocessing to be partitioned in an efficient and flexible way.
- **Interpreting user intention** – The Microchip hybrid mutual and self capacitance method provides unambiguous multitouch performance. Algorithms in the mXT448UD-CCUBHA1 provide optimized touchscreen position filtering for the smooth tracking of touches, responding to a user's intended touches while preventing false touches triggered by ambient noise, conductive material on the sensor surface, such as moisture, or unintentional touches from the user's resting palm or fingers.

mXT448UD-CCUBHA1 1.0

2.0 SCHEMATICS

2.1 88-ball UFBGA

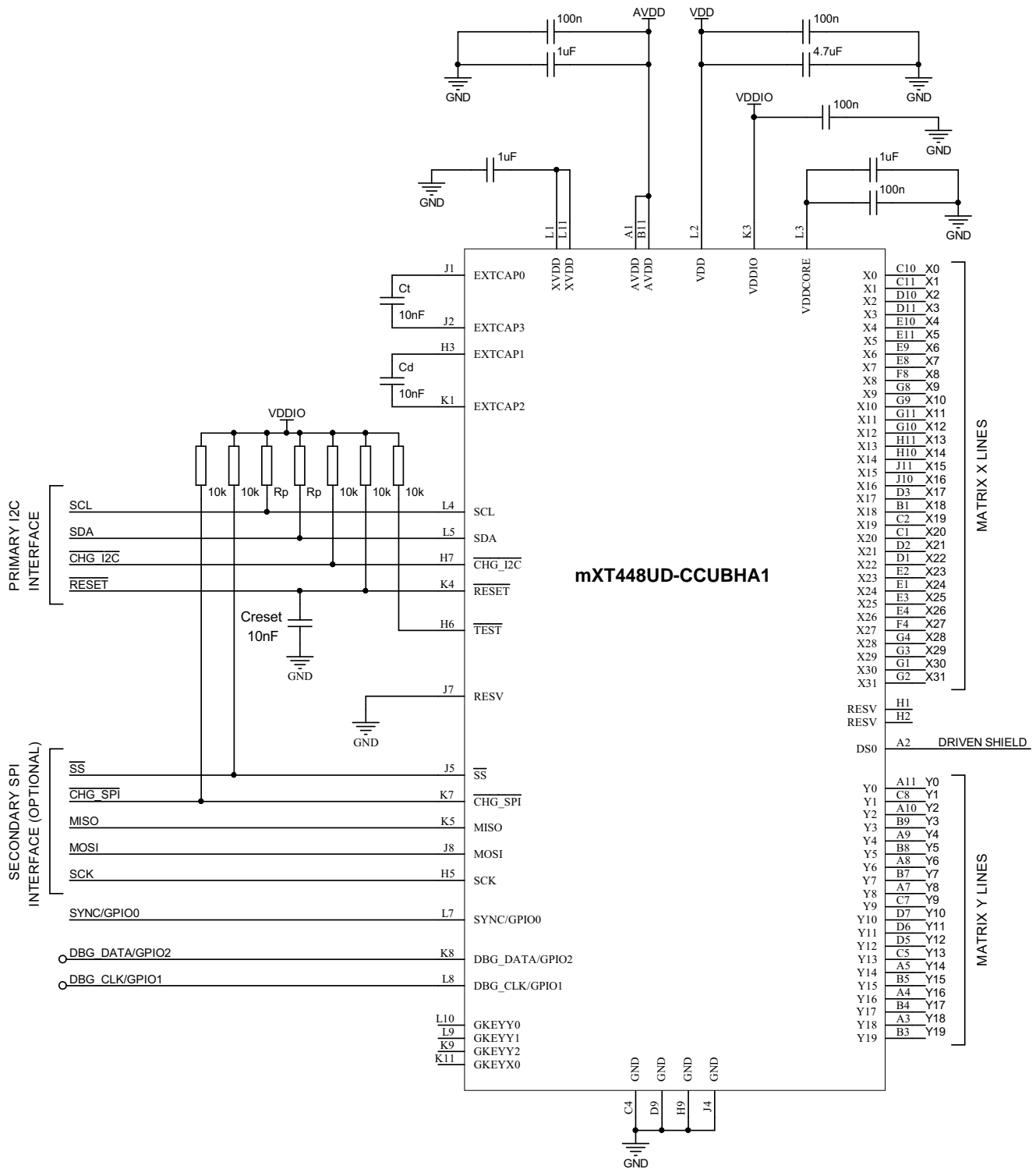

See [Section 2.2 "Schematic Notes"](#).

2.2 Schematic Notes

2.2.1 NUMBER OF AVAILABLE NODES

Although 32 X lines and 20 Y lines are provided, only a maximum of 448 nodes on the matrix can be used for the touchscreen.

2.2.2 POWER SUPPLY

The sense and I/O pins are supplied by the different power rails on the device as listed in [“Pin configuration” on page 3](#).

2.2.3 DECOUPLING CAPACITORS

All decoupling capacitors must be X7R or X5R and placed less than 5 mm away from the pins for which they act as bypass capacitors. Pins of the same type can share a capacitor provided no pin is more than 10 mm from the capacitor.

The schematics on the previous pages show the capacitors required. The parallel combination of capacitors is recommended to give high and low frequency filtering, which is beneficial if the voltage regulators are likely to be some distance from the device (for example, if an active tail design is used). Note that this requires that the voltage regulator supplies for AVdd, Vdd and VddIO are clean and noise free. It also assumes that the track length between the capacitors and on-board power supplies is less than 50 mm.

The number of base capacitors can be reduced if the pinout configuration means that sharing a bypass capacitor is possible (subject to the distance between the pins satisfying the conditions above and there being no routing difficulties).

2.2.4 PULL-UP RESISTORS

The pull-up resistors shown in the schematics are suggested typical values and may be modified to meet the requirements of an individual customer design.

This applies, in particular, to the pull-up resistors on the I²C SDA and SCL lines (shown on the schematic), as the values of these resistors depend on the speed of the I²C interface. See [Section 13.10 “I²C Specification”](#) for details.

2.2.5 VDDCORE

VddCore is internally generated from the Vdd power supply. To guarantee stability of the internal voltage regulator, one or more external decoupling capacitors are required.

2.2.6 XVDD

XVdd power can be supplied either as high voltage (using an internal voltage tripler) or as low voltage (using an internal voltage doubler). The operating mode should be chosen according to the final application.

To operate in voltage tripler mode, the voltage pump requires two external capacitors:

- EXTCAP1 must be connected to EXTCAP2 via a capacitor (Cd).
- EXTCAP0 must be connected to EXTCAP3 via a capacitor (Ct).

To operate in voltage doubler mode, the voltage pump requires one external capacitor:

- EXTCAP1 must be connected to EXTCAP2 via a capacitor (Cd).
- EXTCAP0 and EXTCAP3 can be left unconnected.

Capacitors Cd and Ct should each provide a capacitance of 10 nF. The capacitors must be placed as close as possible to the EXTCAP n pins.

2.2.7 DRIVEN SHIELD LINE

The driven shield line (DS0) should be used to shield the X/Y sense lines. Specifically, it acts as a driven shield in self capacitance operation. See [Section 10.4 “Driven Shield Line”](#) for more details.

2.2.8 MULTIPLE FUNCTION PINS

Some pins may have multiple functions. In this case, only one function can be chosen and the circuit should be designed accordingly.

mXT448UD-CCUBHA1 1.0

2.2.9 SYNC PIN

The mXT448UD-CCUBHA1 has a single SYNC pin that can be used for either frame synchronization (typically connected to VSYNC) or pulse synchronization (typically connected to HSYNC), but not both.

IMPORTANT! Use of the SYNC pin is not considered UL/IEC 60730 Class B compliant.

2.2.10 GPIO PINS

The mXT448UD-CCUBHA1 has 3 GPIO pins. The pins can be set to be either an input or an output, as required, using the GPIO Configuration T19 object.

IMPORTANT! Use of the GPIO pins is not considered UL/IEC 60730 Class B compliant.

If a GPIO pin is unused, it can be left unconnected externally as long as it is given a defined state by the GPIO Configuration T19 object.

By default the GPIO pins are set to be inputs so if a pin is not used, and is left configured as an input, it should be connected to GND through a resistor. Alternatively, the internal pull-up resistor should be enabled (in the GPIO Configuration T19 object) to pull up the pin. Note that this does not apply if the GPIO pin is shared with a debug line; see [Section 2.2.11 "Hardware Debug Interface"](#) for advice on how to treat an unused GPIO pin in this case.

Alternatively, the GPIO pin can be set as an output low using the GPIO Configuration T19 object and left open. This second option avoids any problems should the pin accidentally be configured as output high at a later date.

If the GPIO Configuration T19 object is not enabled for use, the GPIO pins cannot be used for GPIO purposes, although any alternative function can still be used.

Some GPIO pins have alternative functions. If an alternative function is used then this takes precedence over the GPIO function and the pin cannot be used as a GPIO pin. In particular:

- GPIO0 cannot be used if the SYNC function is in use.
- The Hardware Debug Interface functionality is shared with some of the GPIO pins. See [Section 2.2.11 "Hardware Debug Interface"](#) for more details on the Hardware Debug Interface and how to handle these pins if they are totally unused.

2.2.11 HARDWARE DEBUG INTERFACE

IMPORTANT! Use of the Hardware Debug Interface is not considered UL/IEC 60730 Class B compliant.

The DBG_CLK and DBG_DATA lines form the Hardware Debug Interface. These pins should be routed to test points on all designs, such that they can be connected to external hardware during system development and for debug purposes. See also [Section 12.1 "Hardware Debug Interface"](#).

The debug lines may share pins with other functionality. If the circuit is designed to use the Hardware Debug Interface, then any alternative functionality cannot be used. Specifically:

- The DBG_CLK line shares functionality with GPIO1; therefore GPIO1 cannot be used if the Hardware Debug Interface is in use.
- The DBG_DATA line shares functionality with GPIO2; therefore GPIO2 cannot be used if the Hardware Debug Interface is in use.

The DBG_CLK and DBG_DATA lines should not be connected to power or GND. For this reason, where these pins are shared with GPIO pins and they are totally unused (that is, they are not being used as debug or GPIO pins), they should be set as outputs using the GPIO Configuration T19 object.

3.0 TOUCHSCREEN BASICS

3.1 Sensor Construction

A touchscreen is usually constructed from a number of transparent electrodes. These are typically on a glass or plastic substrate. They can also be made using non-transparent electrodes, such as copper or carbon. Electrodes are constructed from Indium Tin Oxide (ITO) or metal mesh. Thicker electrodes yield lower levels of resistance (perhaps tens to hundreds of Ω /square) at the expense of reduced optical clarity. Lower levels of resistance are generally more compatible with capacitive sensing. Thinner electrodes lead to higher levels of resistance (perhaps hundreds of Ω /square) with some of the best optical characteristics.

Interconnecting tracks in ITO can cause problems. The excessive RC time constants formed between the resistance of the track and the capacitance of the electrode to ground can inhibit the capacitive sensing function. In such cases, the tracks should be replaced by screen printed conductive inks (non-transparent) outside the touchscreen viewing area.

3.2 Electrode Configuration

The specific electrode designs used in Microchip touchscreens are the subject of various patents and patent applications. Further information is available on request.

The device supports various configurations of electrodes as summarized in [Section 4.0 "Sensor Layout"](#).

3.3 Scanning Sequence

All nodes are scanned in sequence by the device. Where possible, there is a parallelism in the scanning sequence to improve overall response time. The nodes are scanned by measuring capacitive changes at the intersections formed between the first drive (X) line and all the receive (Y) lines. Then the intersections between the next drive line and all the receive lines are scanned, and so on, until all X and Y combinations have been measured.

The device can be configured in various ways. It is possible to disable some nodes so that they are not scanned at all. This can be used to improve overall scanning time.

3.4 Touchscreen Sensitivity

3.4.1 ADJUSTMENT

Sensitivity of touchscreens can vary across the extents of the electrode pattern due to natural differences in the parasitic capacitance of the interconnections, control chip, and so on. An important factor in the uniformity of sensitivity is the electrode design itself. It is a natural consequence of a touchscreen pattern that the edges form a discontinuity and hence tend to have a different sensitivity. The electrodes at the edges do not have a neighboring electrode on one side and this affects the electric field distribution in that region.

A sensitivity adjustment is available for the whole touchscreen. This adjustment is a basic algorithmic threshold that defines when a node is considered to have enough signal change to qualify as being in detect.

3.4.2 MECHANICAL STACKUP

The mechanical stackup refers to the arrangement of material layers that exist above and below a touchscreen. The arrangement of the touchscreen in relation to other parts of the mechanical stackup has an effect on the overall sensitivity of the screen. The maXTouch technology has an excellent ability to operate in the presence of ground planes close to the sensor. The sensitivity of the maXTouch technology is attributed more to the interaction of the electric fields between the transmitting (X) and receiving (Y) electrodes than to the surface area of these electrodes. For this reason, stray capacitance on the X or Y electrodes does not strongly reduce sensitivity.

Front panel dielectric material has a direct bearing on sensitivity. Plastic front panels are usually suitable up to about 5 mm, and glass up to about 10 mm (dependent upon the screen size and layout). The thicker the front panel, the lower the signal-to-noise ratio of the measured capacitive changes and hence the lower the resolution of the touchscreen. In general, glass front panels are near optimal because they conduct electric fields almost twice as easily as plastic panels.

NOTE Care should be taken using ultra-thin glass panels as retransmission effects can occur, which can significantly degrade performance.
--

mXT448UD-CCUBHA1 1.0

4.0 SENSOR LAYOUT

NOTE The specific electrode designs used in Microchip touchscreens may be the subject of various patents and patent applications. Further information is available on request.

4.1 Electrodes

The device supports various configurations of touch electrodes as summarized below:

- Touchscreen: 1 touchscreen panel occupies a rectangular matrix of 32 X x 20 Y lines (subject to other configurations).
- Standard Keys: Up to 32 keys in an X/Y grid (Key Array), with each node (X/Y intersection) forming a key within the array.
- Generic Keys: Up to 3 keys in an X/Y grid (Key Array), implemented using the Generic Key lines.

NOTE Although there is a total of 52 lines, arranged as a matrix of 32 X by 20 Y, only a maximum of 448 nodes can be used for all the touch objects on this device. The matrix can be made up of any combination of X and Y lines in the design (subject to the limitations described below), provided the X and Y lines are contiguous and subject to the maximum of 448 nodes. For example the matrix could be constructed as a matrix of 32 X by 14 Y lines (giving 448 nodes), as a matrix of 22 X by 20 Y (giving 440 nodes) or as a matrix of any other combination in between. The arrangement chosen depends on the application.

Note that the 3 nodes provided by the Generic Key lines are in addition to the maximum 448 nodes permitted on the device. Using the Generic Keys may add extra noise line measurements, which will impact power consumption and timings. It is therefore recommended that, where spare mutual capacitance sense lines are available, the sense lines are used to form a standard Key Array in preference to using the Generic Key lines.

The physical sensor matrix is configured using one or more touch objects. It is not mandatory to have all the allowable touch objects on the device enabled, nor is it mandatory to use all the rows and columns on the matrix, so objects that are not required can be left disabled (default).

4.2 Sensor Matrix Layout

An example layout is shown in [Figure 4-1](#).

FIGURE 4-1: EXAMPLE LAYOUT – TOUCHSCREEN WITH STANDARD KEY ARRAY

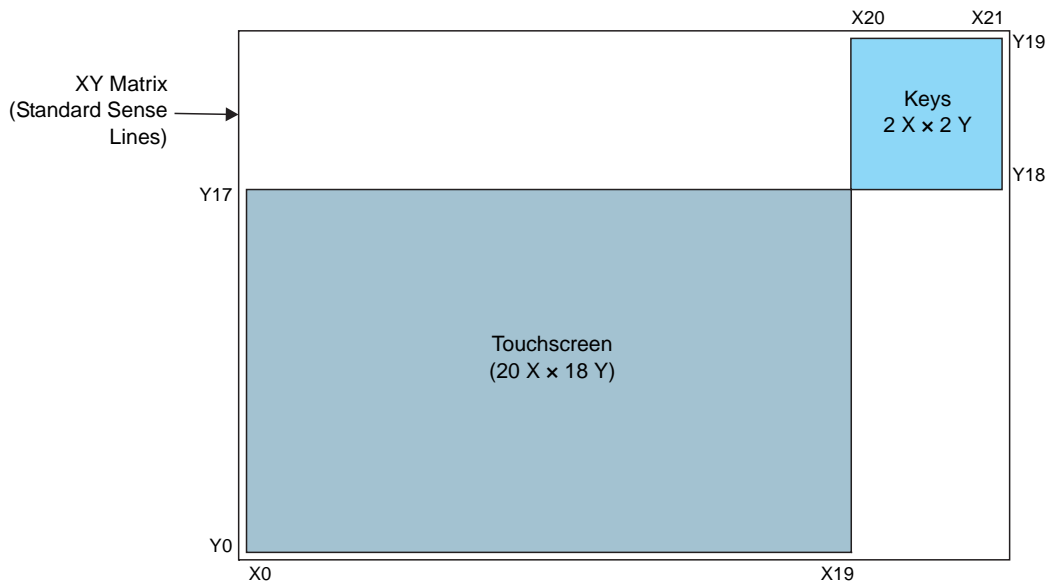
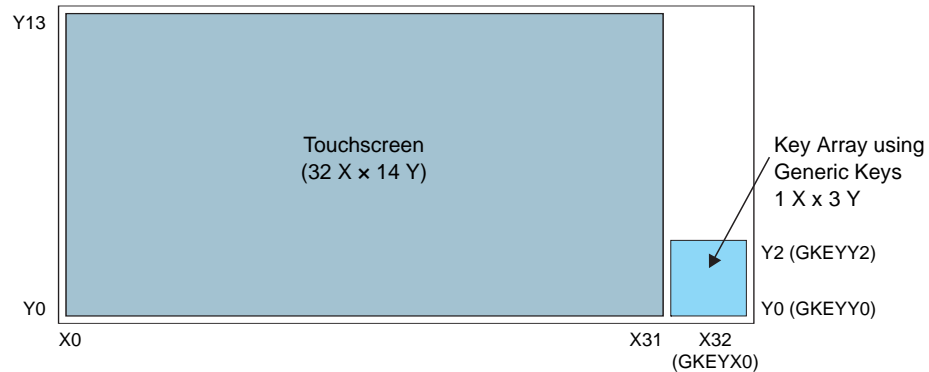

FIGURE 4-2: EXAMPLE LAYOUT – TOUCHSCREEN WITH GENERIC KEYS



Note: Generic Key X line (GKEYX0) is logically situated at X32 and Generic Key Y lines (GKEYY0 to GKEYY2) are logically situated at Y0 to Y2.

When designing the physical layout of the touch panel, the following rules must be obeyed:

- **General layout rules:**

- Each touch object should be a regular rectangular shape in terms of the lines it uses.
- Although each touch object must use a contiguous block of X or Y lines, there can be gaps between the blocks of X and Y lines used for the different touch objects

- **Additional layout rules for Multiple Touch Touchscreen T100:**

- The Multiple Touch Touchscreen T100 object **must** start at (X0, Y0)
- The Multiple Touch Touchscreen T100 object cannot share an X or Y line with another touch object (for example, a Key Array T15) if self capacitance measurements are enabled. Note that sharing of X or Y lines is allowed for mutual capacitance only designs, but this is not recommended for compatibility reasons.
- The touchscreen must contain a minimum of 3 X lines for mutual capacitance measurements. If Dual X Drive is enabled for use in the Noise Suppression T72 object, the minimum is 4 X lines.
- If self capacitance measurements are enabled in the Acquisition Configuration T8 object, the touchscreen must contain a minimum of 10 X lines.
- The touchscreen must contain a minimum of 3 Y lines.
- Self Capacitance touchscreens must have an even number of Y lines if low frequency compensation is used.

- **Additional layout rules for Key Array T15:**

- The standard Key Array must occupy higher X and Y lines than those used by the Multiple Touch Touchscreen T100 object.
- Keys implemented as Generic Keys are in addition to the sensor matrix, and are therefore not affected by the allocation of the sensor X and Y lines.

4.3 Permitted Configurations

The permitted X/Y configurations are shown in [Table 4-1](#).

mXT448UD-CCUBHA1 1.0

TABLE 4-1: PERMITTED TOUCHSCREEN CONFIGURATIONS

		Number of X Lines																																	
		32	31	30	29	28	27	26	25	24	23	22	21	20	19	18	17	16	15	14	13	12	11	10	9	8	7	6	5	4	3	2	1		
Number of Y Lines	20											Y	Y	Y	Y	Y	Y	Y	Y	Y	Y	Y	Y	Y	Y	M	M	M	M	M	M	X			
	19												P	P	P	P	P	P	P	P	P	P	P	P	P	M	M	M	M	M	M	X			
	18																																		
	17																																		
	16																																		
	15																																		
	14	Y	Y	Y	Y	Y	Y	Y	Y	Y	Y	Y	Y	Y	Y	Y	Y	Y	Y	Y	Y	Y	Y	Y	Y	M	M	M	M	M	M	X			
	13	P	P	P	P	P	P	P	P	P	P	P	P	P	P	P	P	P	P	P	P	P	P	P	P	M	M	M	M	M	M	X			
	12	Y	Y	Y	Y	Y	Y	Y	Y	Y	Y	Y	Y	Y	Y	Y	Y	Y	Y	Y	Y	Y	Y	Y	Y	M	M	M	M	M	M	X			
	11	P	P	P	P	P	P	P	P	P	P	P	P	P	P	P	P	P	P	P	P	P	P	P	P	M	M	M	M	M	M	X			
	10	Y	Y	Y	Y	Y	Y	Y	Y	Y	Y	Y	Y	Y	Y	Y	Y	Y	Y	Y	Y	Y	Y	Y	Y	M	M	M	M	M	M	X			
	9	P	P	P	P	P	P	P	P	P	P	P	P	P	P	P	P	P	P	P	P	P	P	P	P	M	M	M	M	M	M	X			
	8	Y	Y	Y	Y	Y	Y	Y	Y	Y	Y	Y	Y	Y	Y	Y	Y	Y	Y	Y	Y	Y	Y	Y	Y	M	M	M	M	M	M	X			
	7	P	P	P	P	P	P	P	P	P	P	P	P	P	P	P	P	P	P	P	P	P	P	P	P	M	M	M	M	M	M	X			
	6	Y	Y	Y	Y	Y	Y	Y	Y	Y	Y	Y	Y	Y	Y	Y	Y	Y	Y	Y	Y	Y	Y	Y	Y	M	M	M	M	M	M	X			
	5	P	P	P	P	P	P	P	P	P	P	P	P	P	P	P	P	P	P	P	P	P	P	P	P	M	M	M	M	M	M	X			
	4	Y	Y	Y	Y	Y	Y	Y	Y	Y	Y	Y	Y	Y	Y	Y	Y	Y	Y	Y	Y	Y	Y	Y	Y	M	M	M	M	M	M	X			
	3	P	P	P	P	P	P	P	P	P	P	P	P	P	P	P	P	P	P	P	P	P	P	P	P	M	M	M	M	M	M	X			
	2																																		
	1																																		

- Key:**
- Y Configuration supported for self capacitance and all mutual capacitance measurements; configuration recommended
 - P Mutual Capacitance measurements: Configuration supported
Self capacitance: Configuration supported, but only if Low Compensation is *not* enabled
 - M Configuration supported for all mutual capacitance measurements; Self Capacitance measurements not supported
 - X Configuration supported for all mutual capacitance measurements, but only if dual X is *not* used; Self Capacitance measurements not supported

4.4 Touchscreen Size

Table 4-2 lists some typical screen size and electrode pitch combinations to achieve various touchscreen aspect ratios.

TABLE 4-2: TYPICAL SCREEN SIZES

Aspect Ratio	Matrix Size	Node Count	Screen Diagonal (Inches)			
			3.8 mm Pitch ⁽²⁾	5 mm Pitch	5.5 mm Pitch	6.5 mm Pitch
Single Touchscreen ⁽¹⁾						
16:10	X = 26, Y = 16	416	4.6	6.0	6.6	7.8
16:9	X = 28, Y = 16	448	4.8	6.4	7.0	8.3
2:1	X = 29, Y = 15	435	4.9	6.4	7.1	8.4

- Note 1:** The figures given in the table are for a Touchscreen and show the largest node count possible to achieve the desired aspect ratio. No provision has been made for a Key Array.
- 2:** Recommended sensor pitch for 1.5 mm passive stylus tip diameter.

4.5 Driven Shield Line

The driven shield line (DS0) should be used to shield the X/Y sense lines. See Section 10.4 "Driven Shield Line" for more details.

5.0 POWER-UP / RESET REQUIREMENTS

5.1 Power-on Reset

There is an internal Power-on Reset (POR) in the device.

If an external reset is to be used the device must be held in $\overline{\text{RESET}}$ (active low) while the digital (Vdd), analog (AVdd) and digital I/O (VddIO) power supplies are powering up. The supplies must have reached their nominal values before the $\overline{\text{RESET}}$ signal is deasserted (that is, goes high). This is shown in Figure 5-1. See Section 13.2 “Recommended Operating Conditions” for nominal values for the power supplies to the device.

FIGURE 5-1: POWER SEQUENCING ON THE MXT448UD-CCUBHA1

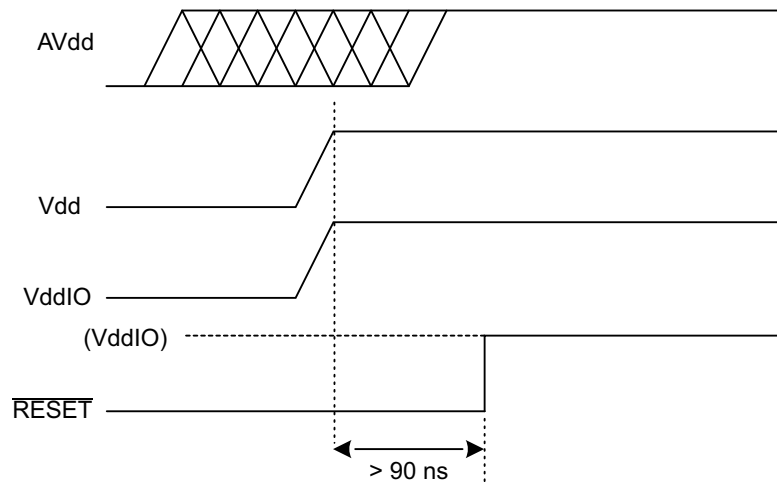

Note: When using external $\overline{\text{RESET}}$ at power-up, VddIO must not be enabled after Vdd

It is recommended that customer designs include the capability for the host to control all the maXTouch power supplies and pull the RESET line low.

After power-up, the device typically takes 135 ms to 450 ms before it is ready to start communications, depending on the configuration.

NOTE Device initialization will not complete until after all the power supplies are present. If any power supply is not present, internal initialization stalls and the device will not communicate with the host.

If the $\overline{\text{RESET}}$ line is released before the AVdd supply has reached its nominal voltage (see Figure 5-2), then some additional operations need to be carried out by the host. There are two options open to the host controller:

- Start the part in Deep Sleep mode and then send the command sequence to set the cycle time to wake the part and allow it to run normally. Note that in this case a calibration command is also needed.
- Send a RESET command.

mXT448UD-CCUBHA1 1.0

FIGURE 5-2: POWER SEQUENCING ON THE MXT448UD-CCUBHA1 – LATE RISE ON AVDD

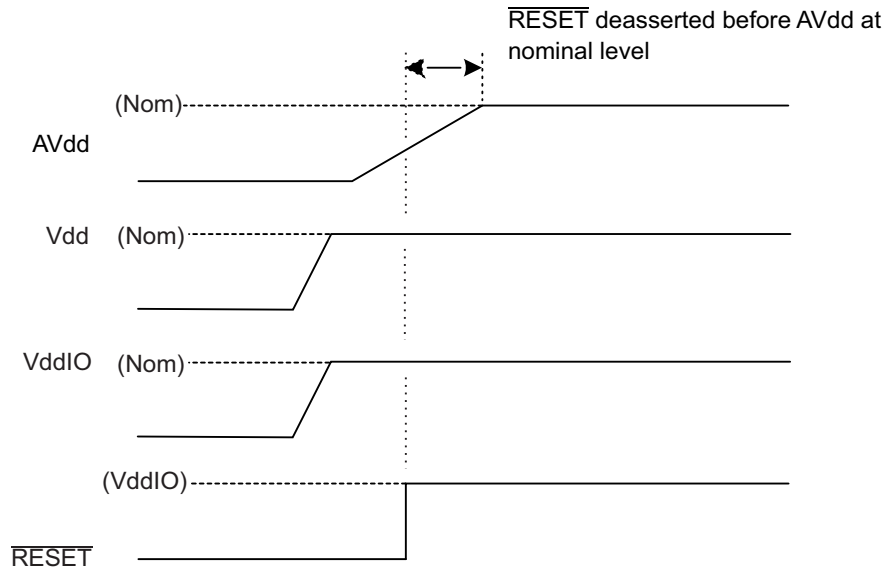

5.2 Hardware Reset

The $\overline{\text{RESET}}$ pin can be used to reset the device whenever necessary. The $\overline{\text{RESET}}$ pin must be asserted low for at least 90 ns to cause a reset. After the host has released the $\overline{\text{RESET}}$ pin, the device typically takes 135 ms to 450 ms before it is ready to start communications, depending on the configuration. It is recommended to connect the $\overline{\text{RESET}}$ pin to a host controller to allow the host to initiate a full hardware reset without requiring the mXT448UD-CCUBHA1 to be powered down.

WARNING The device should be reset only by using the $\overline{\text{RESET}}$ line. If an attempt is made to reset by removing the power from the device without also sending the signal lines low, power will be drawn from the communication and I/O lines and the device will not reset correctly.

Make sure that any lines connected to the device are below or equal to Vdd during power-up and power-down. For example, if $\overline{\text{RESET}}$ is supplied from a different power domain to the VDDIO pin, make sure that it is held low when Vdd is off. If this is not done, the $\overline{\text{RESET}}$ signal could parasitically couple power via the $\overline{\text{RESET}}$ pin into the Vdd supply.

NOTE The voltage level on the $\overline{\text{RESET}}$ pin of the device must never exceed VddIO (digital supply voltage).

5.3 Software Reset

A software RESET command (using the Command Processor T6 object) can be used to reset the chip. A software reset typically takes 165 ms to 480 ms before it is ready to start communications, depending on the configuration.

The reset flag is set in the Command Processor T6 object message data to indicate to the host that it has just completed a reset cycle. This bit can be used by the host to detect any unexpected brownout events. This allows the host to take any necessary corrective actions, such as reconfiguration.

5.4 CHG_I2C and CHG_SPI Lines

After the device has reset, it asserts both the $\overline{\text{CHG_I2C}}$ line and the $\overline{\text{CHG_SPI}}$ line (if configured for use) to signal to the host that a message is available on the corresponding interface.

NOTE The $\overline{\text{CHG_I2C}}$ and $\overline{\text{CHG_SPI}}$ lines are briefly set (~100 ms) as an input during power-up or reset. It is therefore particularly important that the lines should be allowed to float high via the $\overline{\text{CHG_I2C}}$ and $\overline{\text{CHG_SPI}}$ lines pull-up resistors during this period: they should never be driven by the host (see [Section 13.6.3 "Reset Timings"](#)).

At power-on, the device can be configured to perform self tests (using the Self Test Control T10 object) to check for faults in the device.

5.5 Power-up and Reset Sequence – VddIO Enabled after Vdd

The power-up sequence that can be used in applications where VddIO must be powered up after Vdd, is shown in Figure 5-3.

In this case the communication interface to the maXTouch device is not driven by the host system. The $\overline{\text{RESET}}$, $\overline{\text{CHG_I2C}}$ and $\overline{\text{CHG_SPI}}$ lines are connected to VddIO using suitable pull-up resistors. Vdd is powered up, followed by VddIO, no more than 10 ms after Vdd. Due to the pull-up resistors, $\overline{\text{RESET}}$, $\overline{\text{CHG_I2C}}$ and $\overline{\text{CHG_SPI}}$ lines will rise with VddIO. The internal POR system ensures reliable boot up of the device and the $\overline{\text{CHG_I2C}}$ and $\overline{\text{CHG_SPI}}$ lines will go low approximately 135 ms to 450 ms (depending on the configuration) after Vdd to notify the host that the device is ready to start communication.

FIGURE 5-3: POWER-UP SEQUENCE

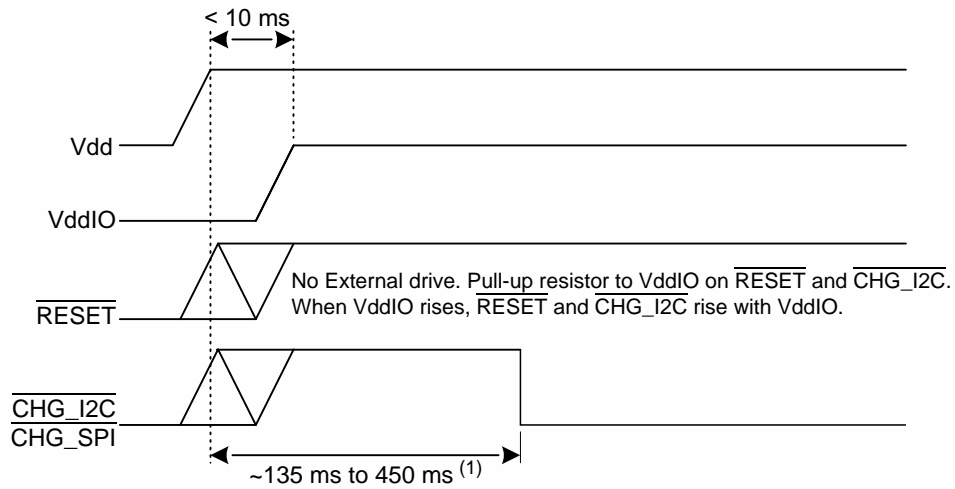

Note 1: Depends on configuration

6.0 DETAILED OPERATION

6.1 Touch Detection

The mXT448UD-CCUBHA1 allows for both mutual and self capacitance measurements, with the self capacitance measurements being used to augment the mutual capacitance measurements to produce reliable touch information.

When self capacitance measurements are enabled, touch classification is achieved using both mutual and self capacitance touch data. This has the advantage that both types of measurement systems can work together to detect touches under a wide variety of circumstances.

Mutual capacitance touch data is used wherever possible to classify touches as this has greater granularity than self capacitance measurements and provides positional information on touches.

Self capacitance measurements, on the other hand, allow for the detection of single touches in extreme cases, such as single thick glove touches, when touches can only be detected by self capacitance data and may be missed by mutual capacitance touch detection.

6.2 Operational Modes

The device operates in two modes: **Active** (touch detected) and **Idle** (no touches detected). Both modes operate as a series of burst cycles. Each cycle consists of a short burst (during which measurements are taken) followed by an inactive sleep period. The difference between these modes is the length of the cycles. Those in idle mode typically have longer sleep periods. The cycle length is configured using the IDLEACQINT and ACTVACQINT settings in the Power Configuration T7. In addition, an *Active to Idle Timeout* setting is provided.

6.3 Detection Integrator

The device features a touch detection integration mechanism. This acts to confirm a detection in a robust fashion. A counter is incremented each time a touch has exceeded its threshold and has remained above the threshold for the current acquisition. When this counter reaches a preset limit the sensor is finally declared to be touched. If, on any acquisition, the signal is not seen to exceed the threshold level, the counter is cleared and the process has to start from the beginning.

The detection integrator is configured using the appropriate touch objects (Multiple Touch Touchscreen T100, Key Array T15).

6.4 Sensor Acquisition

The charge time for mutual capacitance measurements is set using the Acquisition Configuration T8 object. A number of factors influence the acquisition time for a single drive line and the total acquisition time for the sensor as a whole must not exceed 250 ms. If this condition is not met, a SIGERR will be reported.

Care should be taken to configure all the objects that can affect the measurement timing (for example, drift and noise measurement interval settings) so that these limits are not exceeded.

6.5 Calibration

Calibration is the process by which a sensor chip assesses the background capacitance on each node. Calibration occurs in a variety of circumstances, for example:

- When determined by the mutual capacitance recalibration process, as controlled by the Acquisition Configuration T8 object
- When determined by the self capacitance recalibration process, as controlled by the Self Capacitance Configuration T111 object
- When the Retransmission Compensation T80 object detects calibrated-in moisture has been removed
- Following a Self Capacitance Global Configuration T109 Tune command
- When the host issues a recalibrate command
- When certain configuration settings are changed

6.6 Digital Filtering and Noise Suppression

The mXT448UD-CCUBHA1 supports on-chip filtering of the acquisition data received from the sensor. Specifically, the Noise Suppression T72 object provides an algorithm to suppress the effects of noise (for example, from a noisy charger plugged into the user's product). This algorithm can automatically adjust some of the acquisition parameters on-the-fly to filter the Analog-to-Digital Conversions (ADCs) received from the sensor.

Additional noise suppression is provided by the Self Capacitance Noise Suppression T108 object. Similar in both design and configuration to the Noise Suppression T72 object, the Self Capacitance Noise Suppression T108 object is the noise suppression interface for self capacitance touch measurements.

Noise suppression is triggered when a noise source is detected.

- The host driver code can indicate when a noise source is present.
- The noise suppression is also triggered based on the noise levels detected using internal line measurements. The Noise Suppression T72 and Self Capacitance Noise Suppression T108 object selects the appropriate controls to suppress the noise present in the system.

6.7 Functional Safety – UL/IEC 60730 Class B Compliance

- The device is designed with functional safety applications in mind (for example, for the home appliance market). Specifically, the device complies with the UL/IEC 60730 Class B safety specification:
 - User-configurable self diagnostics to detect internal system errors (for example, CPU, memory and system clocks), power, pin fault errors and signal errors for immediate action by the host system (see [Section 12.3 "Self Test"](#)). These tests can be configured to run at power-on/reset and/or as periodic testing during operation.
 - Other built-in automatic system-level tests (for example interrupts, CTE and peripheral I/O)
 - Heartbeat (alive) signal output to host
 - Enhanced communications that includes sequence numbers (timing) and CRC error checking

For more details on the self tests available on the mXT448UD-CCUBHA1, see [Section 12.3 "Self Test"](#).

6.8 EMC Reduction

The mXT448UD-CCUBHA1 has the following mechanisms to help reduce EMC emissions and ensure that the user's product operates within the desired EMC limits:

- **Spread Spectrum** – Varies the burst frequency on each measurement pulse to spread the EMC energy over the frequency domain. This feature is configured by the CTE Configuration T46 object.
- **Configurable Voltage Reference Mode** – Allows for the selection of voltage swing of the self capacitance measurements. This feature is configured by the Self Capacitance Global Configuration T109 object.
- **Input Buffer Power Configuration** – Controls the positive/negative drive strength of the Input Buffer for self capacitance measurements. This feature is configured by the Self Capacitance Global Configuration T109 object.
- **Configurable Input Amplifier Bias** – Controls the Input Amplifier Bias. This feature is configured by the Self Capacitance Global Configuration T109 object.
- **Configurable Wave Shaping** – Controls the voltage modulation on self capacitance scans allows wave shaping of the edge for EMC harmonic control. This feature is configured by the Self Capacitance Voltage Modulation T133 object.

6.9 Shieldless Support and Display Noise Suppression

The mXT448UD-CCUBHA1 can support shieldless sensor design even with a noisy LCD.

The Optimal Integration feature is not filtering as such, but enables the user to use a shorter integration window. The integration window optimizes the amount of charge collected against the amount of noise collected, to ensure an optimal SNR. This feature also benefits the system in the presence of an external noise source. This feature is configured using the Shieldless T56 object.

Display noise suppression allows the device to overcome display noise simultaneously with external noise. This feature is based on filtering provided by the Lens Bending T65 object (see [Section 6.12 "Lens Bending"](#)).

6.10 Retransmission Compensation

The device can limit the undesirable effects on the mutual capacitance touch signals caused by poor device coupling to ground, such as poor sensitivity and touch break-up. This is achieved using the Retransmission Compensation T80 object. This object can be configured to allow the touchscreen to compensate for signal degradation due to these undesirable effects. If self capacitance measurements are also scheduled, the Retransmission Compensation T80 object will use the resultant data to enhance the compensation process.

The Retransmission Compensation T80 object is also capable of compensating for water presence on the sensor if self capacitance measurements are scheduled. In this case, both mutual capacitance and self capacitance measurements are used to detect moisture and then, once moisture is detected, self capacitance measurements are used to detect single touches in the presence of moisture.

6.11 Grip Suppression

The device has grip suppression functionality to suppress false detections from a user's grip.

Grip suppression works by specifying a boundary around a touchscreen, within which touches can be suppressed whilst still allowing touches in the center of the touchscreen. This ensures that an accidental hand touch on the edge is suppressed while still allowing a "real" (finger) touch towards the center of the screen. Mutual capacitance grip suppression is configured using the Grip Suppression T40 object.

Self Capacitance grip suppression works by looking for characteristic shapes in the self capacitance measurement along the touchscreen boundary, and thereby distinguishing between a grip and a touch further into the sensor. Self capacitance grip suppression is configured using the Self Capacitance Grip Suppression T112 object.

6.12 Lens Bending

The device supports algorithms to eliminate disturbances from the measured signal.

When the sensor suffers from the screen deformation (lens bending) the signal values acquired by normal procedure are corrupted by the disturbance component (bend). The amount of bend depends on:

- The mechanical and electrical characteristics of the sensor
- The amount and location of the force applied by the user touch to the sensor
- The Lens Bending T65 object measures the bend component and compensates for any distortion caused by the bend. As the bend component is primarily influenced by the user touch force, it can be used as a secondary source to identify the presence of a touch. The additional benefit of the Lens Bending T65 object is that it will eliminate LCD noise as well.

6.13 Glove Detection

The device has glove detection algorithms that process the measurement data received from the touchscreen classifying touches as potential gloved touches.

The Glove Detection T78 object is used to detect glove touches. In Normal Mode the Glove Detection T78 object applies vigorous glove classification to small signal touches to minimize the effect of unintentional hovering finger reporting. Once a gloved touch is found, the Glove Detection T78 object can enter Glove Confidence Mode. In this mode the device expects the user to be wearing gloves so the classification process is much less stringent.

6.14 Stylus Support

The mXT448UD-CCUBHA1 allows for the particular characteristics of passive stylus touches, whilst still allowing conventional finger touches to be detected. The touch sensitivity and threshold controls for stylus touches are configured separately from those for conventional finger touches so that both types of touches can be accommodated.

Stylus support ensures that the small touch area of a stylus registers as a touch, as this would otherwise be considered too small for the touchscreen. Additionally, there are controls to distinguish a stylus touch from an unwanted approaching finger (such as on the hand holding the stylus).

Passive stylus touches are configured by the Passive Stylus T47 object. There is one instance of the Passive Stylus T47 object for each Multiple Touch Touchscreen T100 object present on the device.

6.15 Unintentional Touch Suppression

The Touch Suppression T42 object provides a mechanism to suppress false detections from unintentional touches from a large body area, such as from a face, ear or palm. The Touch Suppression T42 object also provides Maximum Touch Suppression to suppress all touches if more than a specified number of touches has been detected.

6.16 Adjacent Key Suppression Technology

Adjacent Key Suppression (AKS) technology is a patented method used to detect which touch object (Multiple Touch Touchscreen T100 or Key Array T15) is touched, and to suppress touches on the other touch objects, when touch objects are located close together.

The device has two levels of AKS:

- The first level works between the touch objects (Multiple Touch Touchscreen T100 and Key Array T15). The touch objects are assigned to AKS groups. If a touch occurs within one of the touch objects in a group, then touches within other objects inside that group are suppressed. For example, if a touchscreen and a Key Array are placed in the same AKS group, then a touch in the touchscreen will suppress touches in the Key Array, and vice versa. Objects can be in more than one AKS group.
- The second level of AKS is internal AKS within an individual Key Array object. If internal AKS is enabled, then when one key is touched, touches on all the other keys within the Key Array are suppressed. Note that internal AKS is not present on other types of touch objects.

NOTE AKS can be applied to a Key Array T15 instance that configures either a standard key array or a generic key array.
--

mXT448UD-CCUBHA1 1.0

7.0 HOST COMMUNICATIONS

7.1 Primary Communications Interface

Primary communication between the mXT448UD-CCUBHA1 and a host is achieved using the I²C interface (see [Section 8.0 "I2C Communications"](#)).

The primary communications interface operates as a client interface to the host and is used at power-on for initial communications with the device.

7.1.1 PRIMARY I²C ADDRESS SELECTION

The mXT448UD-CCUBHA1 supports one fixed I²C device address: 0x4B.

7.2 Secondary Communications Interface

Secondary communication between the mXT448UD-CCUBHA1 and a host is achieved using the SPI interface (see [Section 9.0 "SPI Communications"](#)). Use of the secondary interface is optional.

As with the primary communications interface, the secondary interface operates as a client interface to the host. Its main purpose is to allow an alternative communications route for messages (for example, to a second host). Note that the configuration settings, and any firmware updates, must be written to the device using the primary interface.

The secondary interface can be configured only by configuration parameters in the Communications Configuration T18 object once connection with the device has been established using the primary interface.

The pins used to implement the secondary interface may have additional multiplexed functionality. In this case, if the secondary interface is used, the pins cannot be used for their alternative functions.

8.0 I²C COMMUNICATIONS

Communication with the mXT448UD-CCUBHA1 can be carried out over the I²C interface.

The I²C interface is used in conjunction with the $\overline{\text{CHG_I2C}}$ line. The $\overline{\text{CHG_I2C}}$ line going active signifies that a new data packet is available. This provides an interrupt-style interface and allows the device to present data packets when internal changes have occurred. See [Section 8.4 “CHG_I2C Line”](#) for more information.

8.1 I²C Address

The mXT448UD-CCUBHA1 supports one fixed I²C device address: 0x4B.

The I²C address is shifted left to form the SLA+W or SLA+R address when transmitted over the I²C interface, as shown in [Table 8-1](#).

TABLE 8-1: FORMAT OF SLA+W/SLA+R

Bit 7	Bit 6	Bit 5	Bit 4	Bit 3	Bit 2	Bit 1	Bit 0
Address: 0x4B							Read/write

8.2 Writing To the Device

An I²C WRITE cycle consists of the following bytes:

START	1 bit	I ² C START condition
SLA+W	1 byte	I ² C address of the device (see Section 8.1 “I2C Address”)
Address (LSByte, MSByte)	2 bytes	Address of the location at which the data writing starts. This address is stored as the address pointer.
Data	0 .. 11 bytes	The actual data to be written. The data is written to the device, starting at the location of the address pointer. The address pointer returns to its starting value when the I ² C STOP condition is detected. Note that a maximum of 11 bytes of data can be written in any one transaction.
Sequence number	1 byte	The sequence number for this write. The sequence number must start at 0 for the first write after power-up/reset and incremented by 1 for each subsequent write. When the sequence number reaches 255, it is reset to 0.
CRC	1 byte	An 8-bit CRC that includes all the bytes that have been sent, including the two address bytes, but not the SLA+W byte. If the device detects an error in the CRC during a write transfer, a COMSERR fault is reported by the Command Processor T6 object.
STOP	1 bit	I ² C STOP condition

[Figure 8-1](#) shows an example of writing three bytes of data to contiguous addresses starting at 0x1234.

FIGURE 8-1: EXAMPLE OF A THREE-BYTE WRITE STARTING AT ADDRESS 0x1234

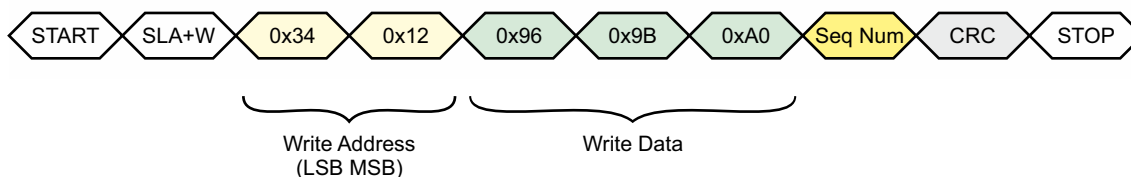

8.3 Reading From the Device

Two I²C bus activities must take place to read from the device. The first activity is an I²C write to set the address pointer (LSByte then MSByte). The second activity is the actual I²C read to receive the data. The address pointer returns to its starting value when the read cycle NACK or STOP is detected.

mXT448UD-CCUBHA1 1.0

It is not necessary to set the address pointer before every read. The address pointer is updated automatically after every read operation. The address pointer will be correct if the reads occur in order. In particular, when reading multiple messages from the Message Processor T5 object, the address pointer is automatically reset to the address of the Message Processor T5 object, in order to allow continuous reads (see [Section 8.3.3 "Reading Status Messages with DMA"](#)).

The WRITE and READ cycles consist of a START condition followed by the I²C address of the device (SLA+W or SLA+R respectively).

NOTE Note that only certain read operations include a CRC of the data packets (see [Section 8.3.1 "checksums for Read Transactions"](#)).

Figure 8-2 shows the I²C commands to read four bytes starting at address 0x1234.

FIGURE 8-2: EXAMPLE OF A FOUR-BYTE READ STARTING AT ADDRESS 0x1234

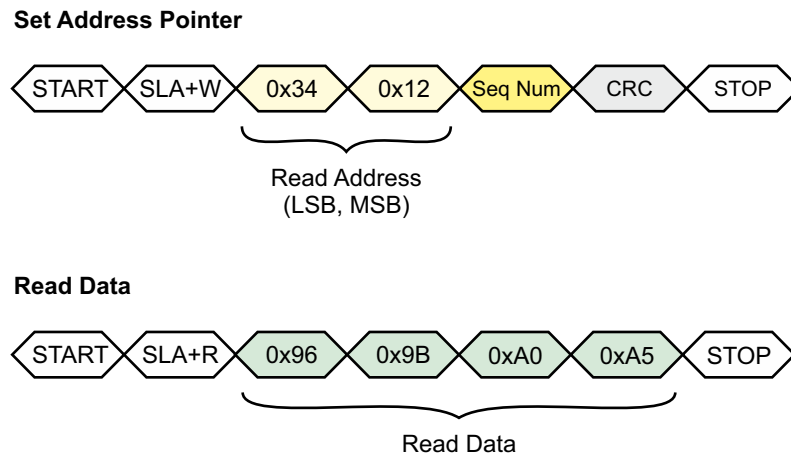

NOTE At least one data byte must be read during an I²C READ transaction; it is illegal to abort the transaction with an I²C STOP condition without reading any data.

8.3.1 CHECKSUMS FOR READ TRANSACTIONS

The following memory locations include a CRC within their data when it is read, so read operations from these memory locations are UL/IEC 60730 Class B compliant:

- Reading status messages from the Message Processor T5 object – All messages include an 8-bit CRC (see [Section 8.3.2 "Reading a Message from the Message Processor T5 Object"](#))
- Reading the Message Count T144 object during DMA access
- Reading the Information Block – The Information Block contains a 24-bit CRC

All other reads do not include a CRC as part of the packet, so it is the host's responsibility to provide alternative means of validating any read data to make it UL/IEC 60730 Class B compliant. For example, any user data stored in the User Data T38 may need to include its own checksum.

8.3.2 READING A MESSAGE FROM THE MESSAGE PROCESSOR T5 OBJECT

An I²C read of the Message Processor T5 object contains the following bytes:

START	1 bit	I ² C START condition
SLA+R	1 byte	I ² C address of the device (see Section 8.1 "I2C Address")
Report ID	1 byte	Message report ID
Data	1 or more bytes	The message data (size = size of Message Processor T5 MESSAGE field)
Sequence number	1 byte	The Message Processor T5 sequence number for this read. The sequence number starts at 0 for the first write after power-up/reset and is incremented by 1 for each subsequent read, wrapping round when it reaches 255.
CRC	1 byte	An 8-bit CRC for the Message Processor T5 report ID, message data and sequence number
STOP	1 bit	I ² C STOP condition

[Figure 8-3](#) shows an example read from the Message Processor T5 object. To read multiple messages using Direct Memory Access, see [Section 8.3.3 "Reading Status Messages with DMA"](#).

FIGURE 8-3: EXAMPLE READ FROM MESSAGE PROCESSOR T5

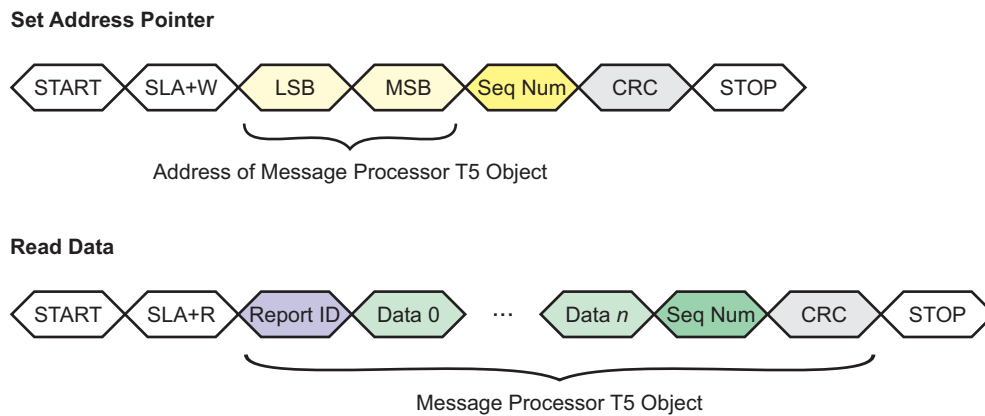

8.3.3 READING STATUS MESSAGES WITH DMA

The device facilitates the easy reading of multiple messages using a single continuous read operation. This allows the host hardware to use a Direct Memory Access (DMA) controller for the fast reading of messages, as follows:

1. The host uses a write operation to set the address pointer to the start of the Message Count T144 object, if necessary. Note that the STOP condition at the end of the read resets the address pointer to its initial location, so it may already be pointing at the Message Count T144 object following a previous message read.
2. The host starts the read operation of the message by sending a START condition.
3. The host reads the Message Count T144 object (two bytes) to retrieve a count of the pending messages, plus the 8-bit CRC.
4. The host calculates the number of bytes to read by multiplying the message count by the size of the Message Processor T5 object. Note that the host should have already read the size of the Message Processor T5 object in its initialization code.
Note that the size of the Message Processor T5 object as recorded in the Object Table includes the sequence number and checksum.
5. The host reads the calculated number of message bytes. It is important that the host does *not* send a STOP condition during the message reads, as this will terminate the continuous read operation and reset the address pointer. No START and STOP conditions must be sent between the messages.
6. The host sends a STOP condition at the end of the read operation after the last message has been read. The NACK condition immediately before the STOP condition resets the address pointer to the start of the Message Count T144 object.

Figure 8-4 shows an example of using a continuous read operation to read three messages from the device.

FIGURE 8-4: CONTINUOUS READ EXAMPLE

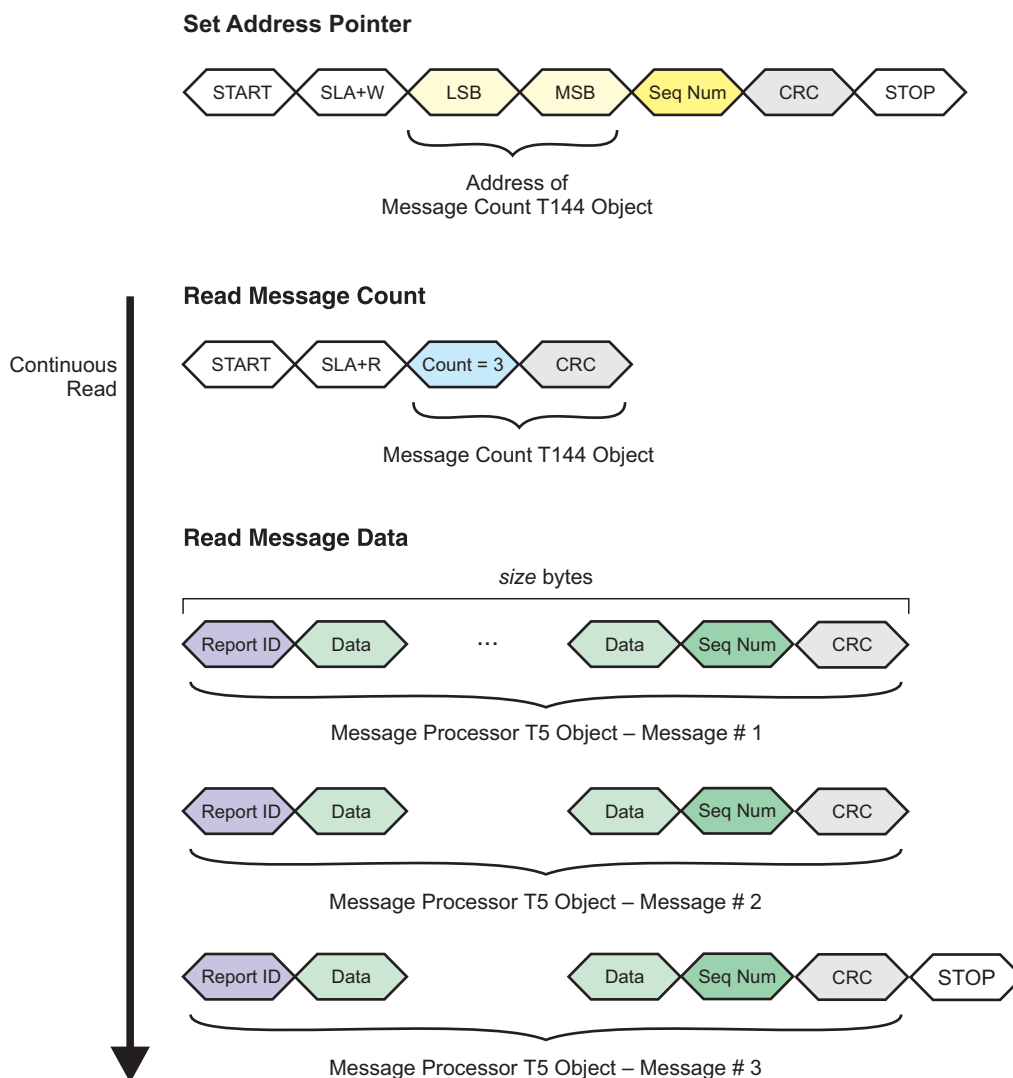

8.4 CHG_I2C Line

The $\overline{\text{CHG_I2C}}$ line is an active-low, open-drain output that is used as an interrupt to alert the host that the client is ready to send a response or that an OBP message is pending and ready to be read from the host. This provides the host with an interrupt-style interface with the potential for fast response times. It reduces the need for wasteful I²C communications.

NOTE The host should always use the $\overline{\text{CHG_I2C}}$ line as an indication that a message is ready to be read from the Message Processor T5 object; the host should never poll the device for messages.

The $\overline{\text{CHG_I2C}}$ line should always be configured as an input on the host during normal usage. This is particularly important after power-up or reset (see Section 5.0 "Power-up / Reset Requirements").

A pull-up resistor is required to VddIO (see Section 2.0 "Schematics").

The $\overline{\text{CHG_I2C}}$ line operates in two modes when it is used with I²C communications, as defined by the Communications Configuration T18 object.

FIGURE 8-5: CHG_I2C LINE MODES FOR I²C-COMPATIBLE TRANSFERS

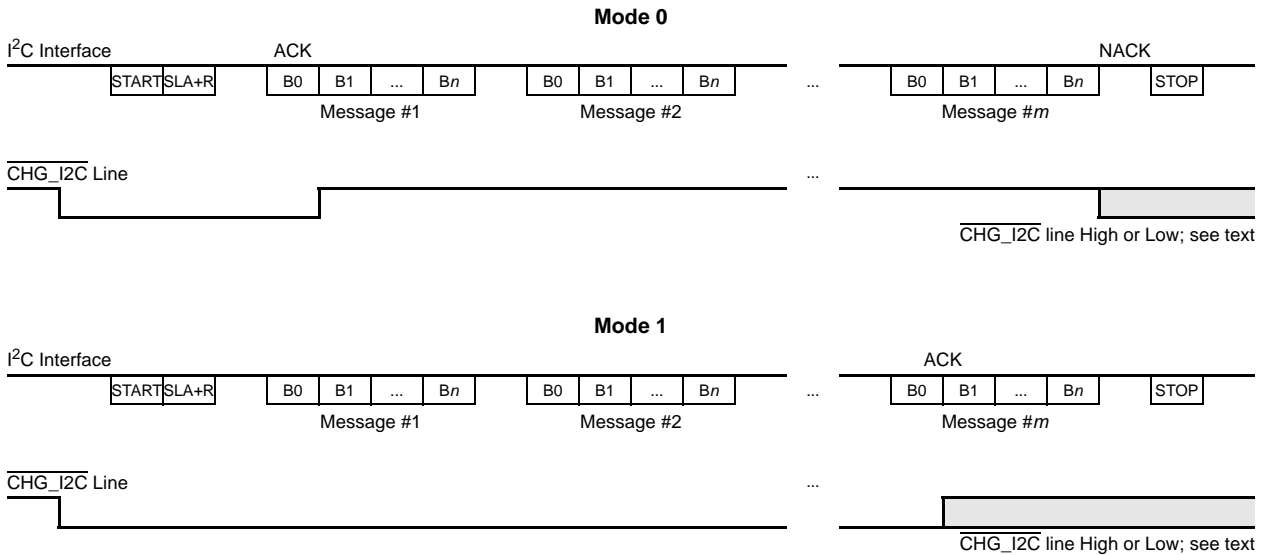

In Mode 0 (edge-triggered operation):

1. The $\overline{\text{CHG_I2C}}$ line goes low to indicate that a message is present.
2. The $\overline{\text{CHG_I2C}}$ line goes high when the first byte of the first message (that is, its report ID) has been sent and acknowledged (ACK sent) and the next byte has been prepared in the buffer.
3. The STOP condition at the end of an I²C transfer causes the $\overline{\text{CHG_I2C}}$ line to stay high if there are no more messages. Otherwise the $\overline{\text{CHG_I2C}}$ line goes low to indicate a further message.

Note that Mode 0 also allows the host to continually read messages by simply continuing to read bytes back without issuing a STOP condition. Message reading should end when a report ID of 255 (“invalid message”) is received. Alternatively the host ends the transfer by sending a NACK after receiving the last byte of a message, followed by a STOP condition. If there is another message present, the $\overline{\text{CHG_I2C}}$ line goes low again, as in step 1. In this mode the state of the $\overline{\text{CHG_I2C}}$ line does not need to be checked during the I²C read.

NOTE If functional safety implementation is required (that is, the user’s product is to comply with UL/IEC 60730 Class B), a report ID of 255 is assumed to be an error. A report ID of 255, therefore, should not be used as an indication of the end of message reading.

In Mode 1 (level-triggered operation):

1. The $\overline{\text{CHG_I2C}}$ line goes low to indicate that a message is present.
2. The $\overline{\text{CHG_I2C}}$ line remains low while there are further messages to be sent after the current message.
3. The $\overline{\text{CHG_I2C}}$ line goes high again only once the first byte of the last message (that is, its report ID) has been sent and acknowledged (ACK sent) and the next byte has been prepared in the output buffer.

Mode 1 allows the host to continually read the messages until the $\overline{\text{CHG_I2C}}$ line goes high, and the state of the $\overline{\text{CHG_I2C}}$ line determines whether or not the host should continue receiving messages from the device.

NOTE The state of the $\overline{\text{CHG_I2C}}$ line should be checked only between messages and not between the bytes of a message. The precise point at which the $\overline{\text{CHG_I2C}}$ line changes state cannot be predicted and so the state of the $\overline{\text{CHG_I2C}}$ line cannot be guaranteed between bytes.

The Communications Configuration T18 object can be used to configure the behavior of the $\overline{\text{CHG_I2C}}$ line. In addition to the $\overline{\text{CHG_I2C}}$ line operation modes described above, this object allows direct control over the state of the $\overline{\text{CHG_I2C}}$ line.

8.5 SDA and SCL

The I²C bus transmits data and clock with SDA and SCL, respectively. These are open-drain. The device can only drive these lines low or leave them open. The termination resistors (R_p) pull the line up to V_{ddIO} if no I²C device is pulling it down.

The termination resistors should be chosen so that the rise times on SDA and SCL meet the I²C specifications for the interface speed being used, bearing in mind other loads on the bus. For best latency performance, it is recommended that no other devices share the I²C bus with the maXTouch controller.

8.6 Clock Stretching

The device supports clock stretching in accordance with the I²C specification. It may also instigate a clock stretch if a communications event happens during a period when the device is busy internally. The maximum clock stretch is 2 ms and typically less than 350 μs.

9.0 SPI COMMUNICATIONS

9.1 Communications Protocol

Communication with the mXT448UD-CCUBHA1 can be carried out over the optional secondary Serial Peripheral Interface (SPI) using a host-client relationship, with the mXT448UD-CCUBHA1 acting in client mode. This is additional to the primary interface.

9.2 SPI Operation

The SPI uses four logic signals:

- **Serial Clock (SCK)** – output from the host.
- **Host Output, Client Input (MOSI)** – output from the host, input to the mXT448UD-CCUBHA1. Used by the host to send data to the mXT448UD-CCUBHA1.
- **Host Input, Client Output (MISO)** – input to the host, output from the mXT448UD-CCUBHA1. Used by the mXT448UD-CCUBHA1 to send data to the host.
- **Serial Select (\overline{SS})** – active low output from the host.

In addition the following pin is used:

- **Change Line ($\overline{CHG_SPI}$)** – active low input to the host, output from the mXT448UD-CCUBHA1. Used by the mXT448UD-CCUBHA1 to indicate that a response is ready for transmission (see [Section 9.2.1 “CHG_SPI Line”](#)) or that an OBP message is ready to be read.

The host pulls \overline{SS} low at the start of the SPI transaction and it remains low until the end of the SPI transaction.

At each byte, the host generates 8 clock pulses on SCK. With these 8 clock pulses, a byte of data is transmitted from the host to the client over MOSI, most significant bit first.

Simultaneously a byte of data is transmitted from the client to the host over MISO, also most significant bit first.

The mXT448UD-CCUBHA1 requires that the clock idles “high” (CPOL=1). The data on MOSI and MISO pins are set at the falling edges and sampled at the rising edges (CPHA=1). This is known as SPI Mode 3.

The mXT448UD-CCUBHA1 SPI interface can operate at a SCK frequency of up to 8 MHz.

NOTE The SPI interface is used in half duplex mode, even though it is a full duplex communication bus by its nature. This simplifies the protocol, minimizes the CPU processing required and avoids possible timing critical scenarios. This means that only one of the two in/out data lines (MOSI/MISO) will be meaningful at a time. During a read operation, therefore, the host must transmit 0xFF bytes on the MOSI line while it is reading data from the device. Similarly, during a write operation, the host must ignore the data on the MISO line.

An SPI transaction is considered as initiated when the \overline{SS} line is asserted (active low) by the host and terminated when it is deasserted. The host can abort a transfer at any time by deasserting the \overline{SS} line.

9.2.1 $\overline{CHG_SPI}$ LINE

The $\overline{CHG_SPI}$ line is an active-low, open-drain output that is used as an interrupt to alert the host that the client is ready to send a response or that an OBP message is pending and ready to be read from the host.

NOTE The host should always use the $\overline{CHG_SPI}$ line as an indication that a message is ready to be read from the Message Processor T5 object; the host should never poll the device for messages.

The $\overline{CHG_SPI}$ line must be handled by the host as a falling edge triggered line. It must not be used a level triggered line. This avoids the situation in which the host initiates a new read/write operation (because the interrupt line is still asserted following a previous SPI transaction) but the target is not yet ready to handle it.

To prevent the host missing an interrupt, the target device can use a retriggering mechanism for the interrupt line. This guarantees that any pending message is always delivered. This mechanism must be enabled in the Communications Configuration T18 object.

mXT448UD-CCUBHA1 1.0

9.2.2 SPI PROTOCOL OPCODES

The allowed operations and responses codes used by the SPI protocol are shown in [Table 9-1](#).

TABLE 9-1: SPI OPCODES

Name	Value	Operation
Write Operation and Responses (see Section 9.3 "Write Operation and Responses")		
SPI_WRITE_REQ	0x01	Write operation request
SPI_WRITE_OK	0x81	Write operation succeeded (response)
SPI_WRITE_FAIL	0x41	Write operation failed (response)
Read Operation and Responses (see Section 9.4 "Read Operation and Responses")		
SPI_READ_REQ	0x02	Read operation request
SPI_READ_OK	0x82	Read operation succeeded (response)
SPI_READ_FAIL	0x42	Read operation failed (response)
General Responses (see Section 9.5 "General Operations")		
SPI_INVALID_REQ	0x04	Invalid operation (response)
SPI_INVALID_CRC	0x08	Invalid Header CRC (response)

All the responses reported in [Table 9-1](#) require the Interrupt line to go from inactive (deasserted) to active (asserted) before the host can read a response following an SPI_READ_REQ or SPI_WRITE_REQ operation.

9.2.3 SPI TRANSACTION HEADER

Every SPI transaction includes a 6-byte HEADER that has the format shown in [Table 9-2](#).

TABLE 9-2: HEADER FORMAT

Byte	Field	Description
0	Opcode	Op code for the transaction
1	Address LSByte	The memory address of the client device where the host wants to write to or read from.
2	Address MSByte	
3	Length LSByte	The number of bytes that the host wants to write to or read from the client device.
4	Length MSByte	
5	Header CRC	8-bit CRC of the header information

An 8-bit CRC is used to detect errors on the 5 bytes of the header (that is: Opcode, Address LSB, Address MSB, Length LSByte, Length MSByte) in order to prevent the writing to or reading from unwanted objects if the header gets corrupted during the SPI transfer. The 8-bit CRC algorithm is the same as that used to calculate the CRC for Message Processor T5 messages.

9.3 Write Operation and Responses

The write operation and its responses allows the host to write to an object configuration area.

The flow and timing are shown in [Figure 9-1](#).

Note that no detection mechanism is provided at the SPI network layer level on the data written, but the host can check the correctness of the data that is read back by using a checksum. This allows the host to detect whether the payload of the write operation was corrupted or not during the SPI transaction.

FIGURE 9-1: SPI WRITE CONFIGURATION MESSAGE FLOW AND TIMING

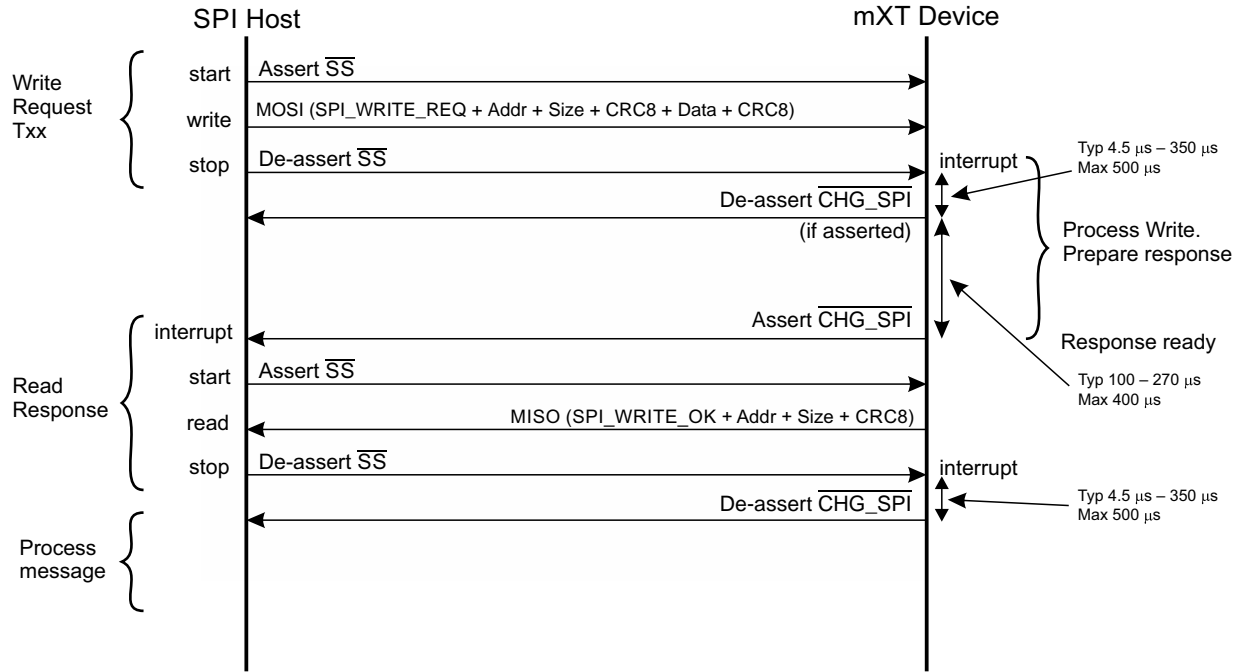

9.3.1 SPI_WRITE_REQ

Figure 9-2 shows the message format used for the write request operation.

FIGURE 9-2: SPI_WRITE_REQ

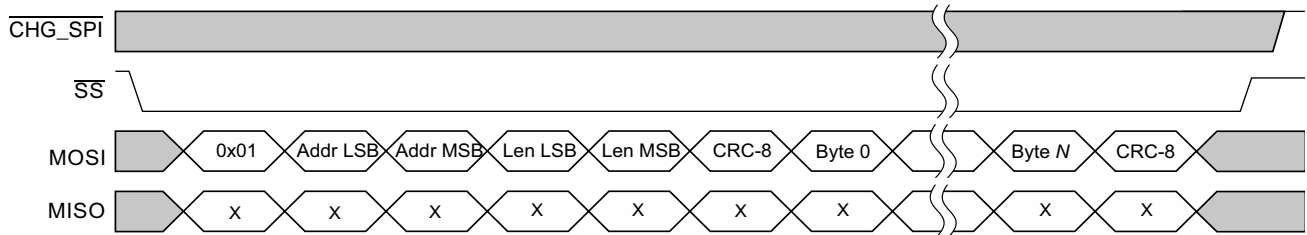

In Figure 9-2:

- **0x01** is the opcode.
- **Addr LSB and Addr MSB** together specify the address to which the host wishes to write.
- **Len LSB and Len MSB** together specify the length of the data in bytes. This is the total number of bytes that the host wishes to write to the device (excluding the header bytes), including the data CRC.
- **CRC-8** is the 8-bit header CRC.
- **Byte 0 .. Byte N** contain the data that is to be written (14 bytes maximum).
- **CRC-8** is the 8-bit data CRC. This is mandatory on any write request that contains data bytes.

If more than 15 data bytes (including the CRC byte) is sent, the device discards the entire data and reports a Command Processor T6 COMSERR message. If the host needs to write more than 14 bytes of data (plus the CRC), multiple SPI_WRITE_REQ operations are required.

Following an SPI_WRITE_REQ operation, the host must wait for a response from the device before accessing the SPI bus again. If the client system does not assert the interrupt line within 10 ms, a hardware reset or a retry from the host is necessary. When the response is ready to be sent, the target device asserts the interrupt line to notify the host that a message is ready to be read. Only at this point is the host allowed to initiate a new SPI transaction to read back the response related to the previous write operation.

mXT448UD-CCUBHA1 1.0

This means that an object message will be blocked during the time that a response related to a previous read or write request is pending and has not yet been read back by the host.

The following responses are possible following an SPI_WRITE_REQ operation:

- **SPI_WRITE_OK** – Generated if the write operation was successfully completed (the memory address and length specified by the host were within the allowed accessible memory map regions). See [Section 9.3.2 “SPI_WRITE_OK”](#).
- **SPI_WRITE_FAIL** – Generated if the write operation failed, for example if the host tries to write to an address outside the available memory map. See [Section 9.3.3 “SPI_WRITE_FAIL”](#).
- **SPI_INVALID_REQ** – See [Section 9.5.1 “SPI_INVALID_REQ”](#).
- **SPI_INVALID_CRC** – See [Section 9.5.2 “SPI_INVALID_CRC”](#).

9.3.2 SPI_WRITE_OK

Figure 9-3 shows the message format used for the write OK response.

FIGURE 9-3: SPI_WRITE_OK

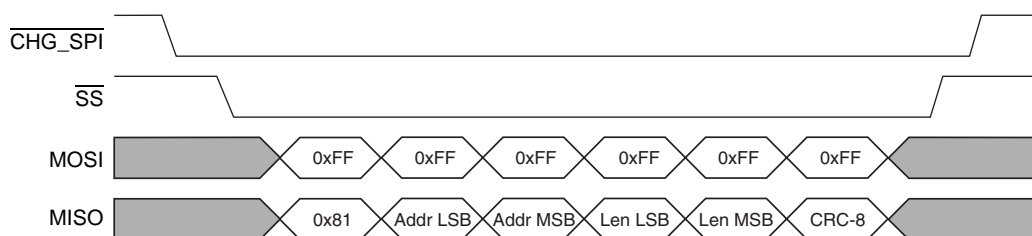

In Figure 9-3:

- **0x81** is the opcode.
- **Addr LSB and Addr MSB** together specify the address to which the data was written.
- **Len LSB and Len MSB** together specify the length of the data in bytes. This is the total number of bytes that was written to the device (excluding the header bytes), including the data CRC.
- **CRC-8** is the 8-bit header CRC.

9.3.3 SPI_WRITE_FAIL

Figure 9-4 shows the message format used for the write fail response.

FIGURE 9-4: SPI_WRITE_FAIL

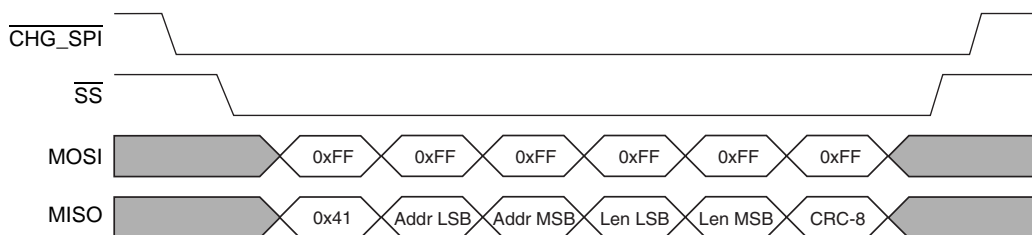

In Figure 9-4:

- **0x41** is the opcode.
- **Addr LSB and Addr MSB** together specify the address to which the host requested the write.
- **Len LSB and Len MSB** together specify the length of the data in bytes. This is the total number of bytes that the host attempted to write to the device (excluding the header bytes).
- **CRC-8** is the 8-bit header CRC.

9.4 Read Operation and Responses

The read request operation allows the host to read from the object memory map for the device. This allows the host to read a message from the Message Processor T5 object or read from an object configuration area.

The flow and timing are shown in Figure 9-5.

FIGURE 9-5: SPI READ CONFIGURATION MESSAGE FLOW AND TIMING

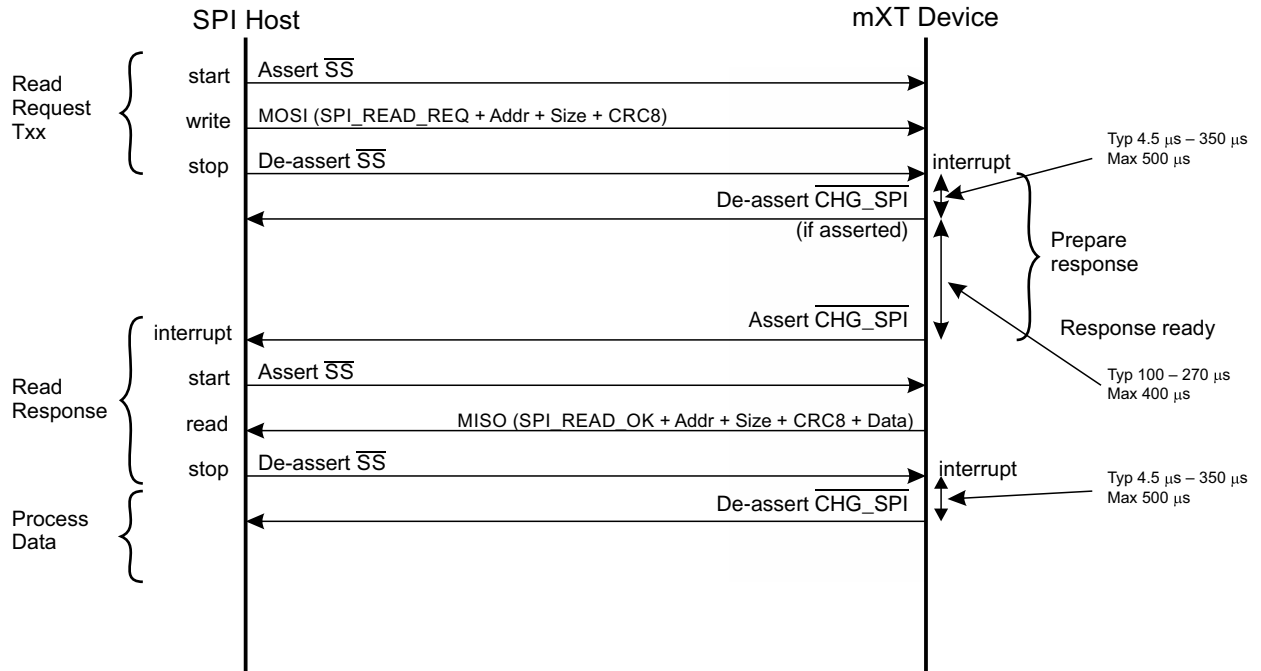

The limit on the size of data that can be read depends on the type of read operation:

- A limit of 64 bytes of data is normally allowed for data reads. If the host tries to read more than 64 bytes, the client returns SPI_READ_FAIL (see Section 9.4.3 “SPI_READ_FAIL”).
- For DMA reads from the Data Container T117 object, the limit is 1290 bytes of data to be read, spanning the 6 instances of the Data Container T117 object in a contiguous manner.
- In order to ensure UL/IEC 60730 Class B compliance when reading messages, the limit for the data read is reduced to a maximum of 15 bytes when reading Message Processor T5 messages (14 bytes of message data plus the CRC).

• Both the normal data reads and the Data Container T117 reads are not considered UL/IEC 60730 Class B compliant and should not be used for production use.

9.4.1 SPI_READ_REQ

Figure 9-6 shows the message format used for the read request operation.

FIGURE 9-6: SPI_READ_REQ

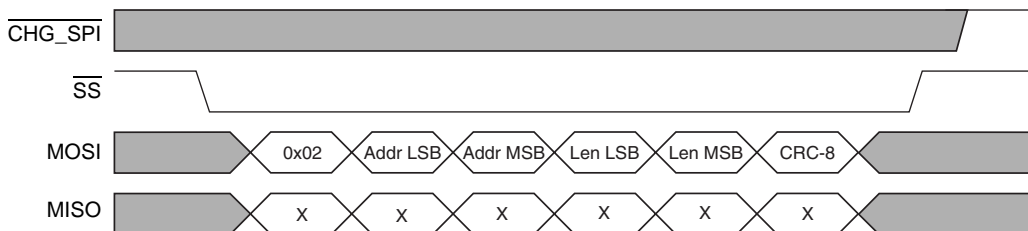

mXT448UD-CCUBHA1 1.0

The SPI_READ_REQ operation can be initiated by the host at any time, regardless of the state of the interrupt line. The device will assert the interrupt line when there are object messages pending. When the host asserts \overline{SS} (whether to respond to the client asserting the interrupt line or because the host wants to initiate a transaction), the interrupt line is deasserted until the message from the host has been received and processed.

In [Figure 9-6](#):

- **0x02** is the opcode.
- **Addr LSB and Addr MSB** together specify the address from which the host wishes to read.
- **Len LSB and Len MSB** together specify the length of the data in bytes. This is the total number of bytes (excluding the header bytes) that the host wishes to read from the device. For normal reads, the limit is 15 bytes (including any sequence number and data CRC; see [Section 9.4.3.1 “Checksum on Reads”](#) and [Section 9.4.3.2 “Checksum on Message Processor T5 Messages”](#)). For a block data transfer from Data Container T117 instances, the limit is 1290 bytes.
- **CRC-8** is the 8-bit header CRC.

The actual data is sent in the subsequent SPI_READ_OK operation.

Following an SPI_READ_REQ operation, the host must wait for a response to be ready from the device before accessing the SPI bus again. If the client system does not assert the interrupt line within 10 ms, a hardware reset or a retry from the host is necessary. When the response is ready to be sent, the target device asserts the interrupt line to notify the host that a message is ready to be read. Only at this point is the host allowed to initiate a new SPI transaction to read back the response related to the previous read operation.

The following responses are possible following an SPI_READ_REQ operation:

- **SPI_READ_OK** – Generated if the read operation was successfully completed (the memory address and length specified by the host were within the allowed accessible memory map regions). See [Section 9.4.2 “SPI_READ_OK”](#).
- **SPI_READ_FAIL** – Generated if the read operation failed, for example if the host tries to read from an address outside the available memory map. See [Section 9.4.3 “SPI_READ_FAIL”](#).
- **SPI_INVALID_REQ** – See [Section 9.5.1 “SPI_INVALID_REQ”](#).
- **SPI_INVALID_CRC** – See [Section 9.5.2 “SPI_INVALID_CRC”](#).

9.4.2 SPI_READ_OK

[Figure 9-7](#) shows the message format used for the read OK response.

FIGURE 9-7: SPI_READ_OK

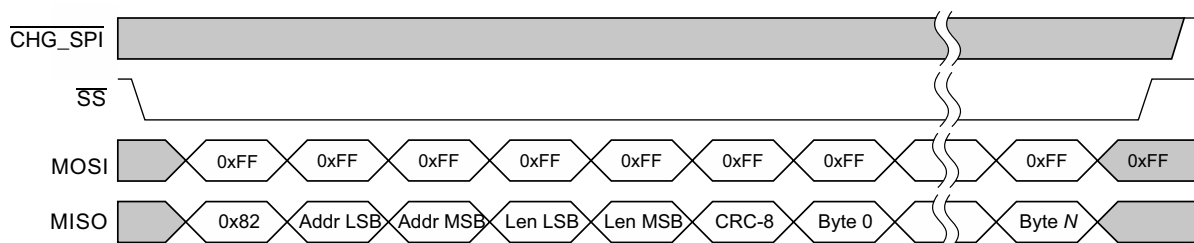

In [Figure 9-7](#):

- **0x82** is the opcode.
- **Addr LSB and Addr MSB** together specify the address from which the host requested the data should be read.
- **Len LSB and Len MSB** together specify the length of the data in bytes (including any sequence number and data CRC if appropriate).
- **CRC-8** is the 8-bit header CRC.
- **Byte 0 .. Byte N** contain the data that is read from the device (including any sequence number and data CRC if appropriate).

Note that, although the device flushes the transmit buffer when the host performs a read operation, any attempt by the host to read more data than expected (that is, greater than Len bytes) could cause the device to transmit indeterminate data on the MISO line.

9.4.3 SPI_READ_FAIL

Figure 9-8 shows the message format used for the read fail response.

FIGURE 9-8: SPI_READ_FAIL

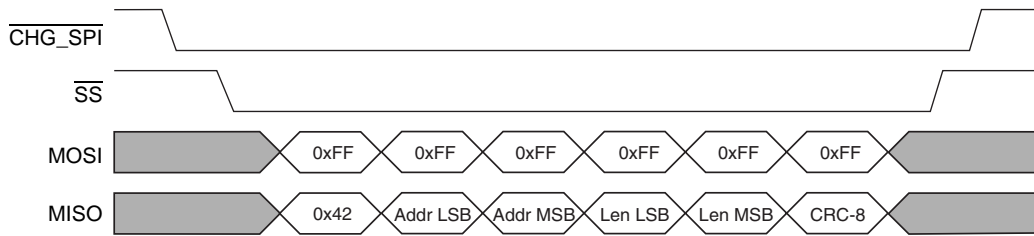

In Figure 9-8:

- **0x42** is the opcode.
- **Addr LSB and Addr MSB** together specify the address from which the host requested the data should be read.
- **Len LSB and Len MSB** together specify the length of the data in bytes. This is the total number of bytes that the host attempted to read from the device (excluding the header bytes).
- **CRC-8** is the 8-bit header CRC.

9.4.3.1 Checksum on Reads

Under certain circumstances, a CRC can be used as an error detection mechanism when reading an object:

- Message Processor T5 – When reading a message from the Message Processor T5 object, a CRC is provided as an error detection mechanism (see Section 9.4.3.2 “Checksum on Message Processor T5 Messages”).
- Message Count T144 – When using DMA reads, a CRC is provided to validate the integrity of the Message Count T144 object.
- Data Container T117 – When performing a block data transfer from Data Container T117 instances, the header bytes within the data can be configured to provide a CRC for some types of data. However, the CRC is only an 8-bit CRC and is therefore not considered UL/IEC 60730 Class B compliant.
- All other objects – When reading from any other object configuration area, no error detection mechanism is provided, as this operation is typically performed only at system startup. It is possible, however, to verify a read operation by performing it twice and comparing the results.

9.4.3.2 Checksum on Message Processor T5 Messages

Figure 9-9 shows the message format used for the response to a read request for a Message Processor T5 message. Note that the 8-bit CRC is returned as the last byte in the message.

FIGURE 9-9: SPI_READ_OK – MESSAGE PROCESSOR T5 MESSAGE WITH CHECKSUM

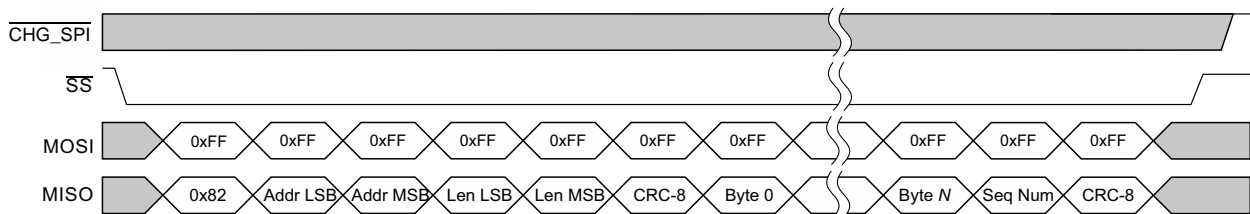

mXT448UD-CCUBHA1 1.0

In [Figure 9-9](#):

- **0x82** is the opcode.
- **Addr LSB and Addr MSB** together specify the address from which the host requested the data should be read.
- **Len LSB and Len MSB** together specify the length of the data in bytes. This is the total number of bytes that the host requested to read from the device (excluding the header bytes), including a sequence number and the data CRC.
- **CRC-8** is the 8-bit header CRC.
- **Byte 0 .. Byte N** contain the message data written (maximum 13 bytes).
- **Seq Num** is the sequence number of the message.
- **CRC-8** is the 8-bit data CRC for the message data plus the sequence number.

9.5 General Operations

9.5.1 SPI_INVALID_REQ

[Figure 9-10](#) shows the message format used for the Invalid Request response. The purpose of this opcode is to report to the host that the opcode of the last request was not recognized or that the host has tried to perform another read or write operation without waiting for the response from the previous request.

FIGURE 9-10: SPI_INVALID_REQ

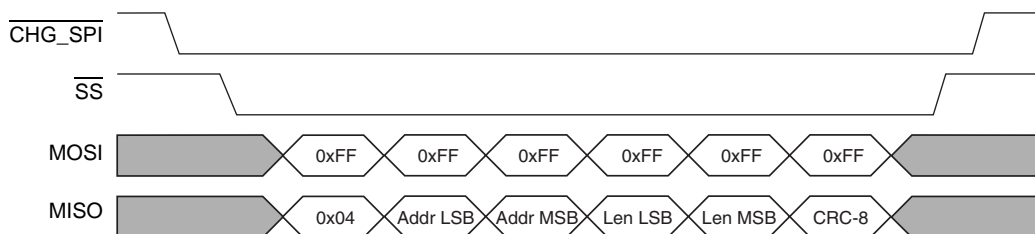

In [Figure 9-10](#):

- **0x04** is the opcode.
- **Addr LSB and Addr MSB** together specify the address received in the invalid request.
- **Len LSB and Len MSB** together specify the length of the data in bytes. This is the total number of bytes that the host attempted to read from or write to from the device (excluding the header bytes).
- **CRC-8** is the 8-bit header CRC.

9.5.2 SPI_INVALID_CRC

[Figure 9-11](#) shows the message format used for the Invalid CRC response. The purpose of this opcode is to report an error in the CRC check performed on the received message header. Note that if a CRC fails on any received data, the device reports a Command Processor T6 COMSERR message.

FIGURE 9-11: SPI_INVALID_CRC

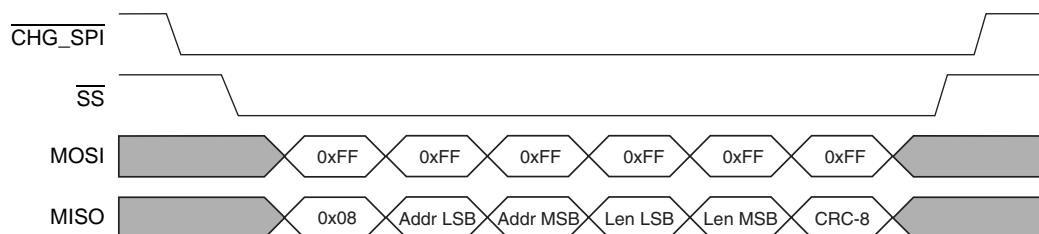

In Figure 9-11:

- **0x08** is the opcode.
- **Addr LSB and Addr MSB** together specify the address received in the last request.
- **Len LSB and Len MSB** together specify the length of the data in bytes. This is the total number of bytes that the host attempted to read from or write to from the device in the last request (excluding the header bytes).
- **CRC-8** is the 8-bit CRC.

9.6 Example of a Failed Transaction

In order to prevent unpredictable system behavior, the host *must* always wait for the response of the last request issued to be ready before initiating a new SPI request transaction. If the host does not comply with the protocol specification, clashes can occur.

For example, Figure 9-12 shows the situation in which an SPI_READ_OK (0x82) response with a payload of 3 bytes is expected, but the host performs an SPI_WRITE_REQ (0x01) operation instead to write 5 bytes to address *Addr1*. In this case, the device outputs the SPI_READ_OK data on the MISO line (this will have been prepared in advance before the interrupt line was asserted) and ignores the new host request received on the MOSI line. The device will send the host an SPI_INVALID_REQ response, in response to the following read or write request, to indicate a violation of the SPI protocol.

FIGURE 9-12: EXAMPLE CLASH – SPI_WRITE_REQ WHEN SPI_READ_OK IS EXPECTED

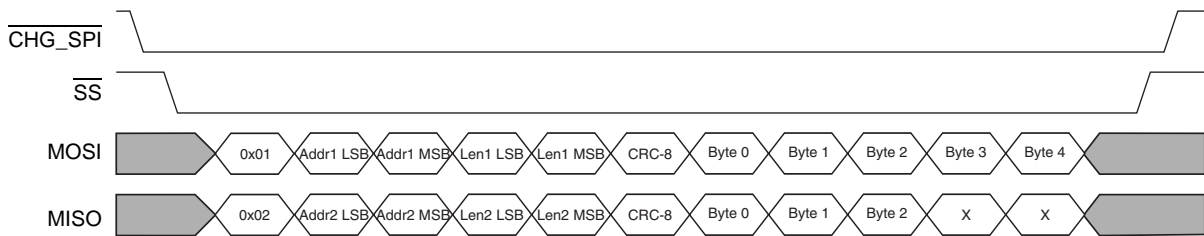

mXT448UD-CCUBHA1 1.0

10.0 PCB DESIGN CONSIDERATIONS

10.1 Introduction

The following sections give the design considerations that should be adhered to when designing a PCB layout for use with the mXT448UD-CCUBHA1. Of these, power supply and ground tracking considerations are the most critical.

By observing the following design rules, and with careful preparation for the PCB layout exercise, designers will be assured of a far better chance of success and a correctly functioning product.

10.2 Printed Circuit Board

Microchip recommends the use of a four-layer printed circuit board for mXT448UD-CCUBHA1 applications. This, together with careful layout, will ensure that the board meets relevant EMC requirements for both noise radiation and susceptibility, as laid down by the various national and international standards agencies.

10.2.1 PCB CLEANLINESS

Modern no-clean-flux is generally compatible with capacitive sensing circuits.

CAUTION! If a PCB is reworked to correct soldering faults relating to any device, or to any associated traces or components, be sure that you fully understand the nature of the flux used during the rework process. Leakage currents from hygroscopic ionic residues can stop capacitive sensors from functioning. If you have any doubts, a thorough cleaning after rework may be the only safe option.

10.3 Power Supply

10.3.1 SUPPLY QUALITY

While the device has good Power Supply Rejection Ratio properties, poorly regulated and/or noisy power supplies can significantly reduce performance.

Particular care should be taken of the AVdd supply, as it supplies the sensitive analog stages in the device.

10.3.2 SUPPLY RAILS AND GROUND TRACKING

Power supply and clock distribution are the most critical parts of any board layout. Because of this, it is advisable that these be completed before any other tracking is undertaken. After these, supply decoupling, and analog and high speed digital signals should be addressed. Track widths for all signals, especially power rails should be kept as wide as possible in order to reduce inductance.

The Power and Ground planes themselves can form a useful capacitor. Flood filling for either or both of these supply rails, therefore, should be used where possible. It is important to ensure that there are no floating copper areas remaining on the board: all such areas should be connected to the ground plane. The flood filling should be done on the outside layers of the board.

10.3.3 POWER SUPPLY DECOUPLING

Decoupling capacitors should be fitted as specified in [Section 2.2 "Schematic Notes"](#).

The decoupling capacitors must be placed as close as possible to the pin being decoupled. The traces from these capacitors to the respective device pins should be wide and take a straight route. They should be routed over a ground plane as much as possible. The capacitor ground pins should also be connected directly to a ground plane.

Surface mounting capacitors are preferred over wire-leaded types due to their lower ESR and ESL. It is often possible to fit these decoupling capacitors underneath and on the opposite side of the PCB to the digital ICs. This will provide the shortest tracking, and most effective decoupling possible.

10.3.4 VOLTAGE PUMP

The traces for the voltage pump capacitors between EXTCAP1 and EXTCAP2 and between EXTCAP0 and EXTCAP3 (Cd and Ct on the schematic in [Section 2.0 "Schematics"](#)) should be kept as short and as wide as possible for best pump performance. They should also be routed as parallel and as close as possible to each other in order to reduce emissions, and ideally the traces should be the same length.

10.3.5 VOLTAGE REGULATORS

Each supply rail requires a Low Drop-Out (LDO) voltage regulator, although an LDO can be shared where supply rails share the same voltage level.

Figure 10-1 shows an example circuit for an LDO.

FIGURE 10-1: EXAMPLE LDO CIRCUIT

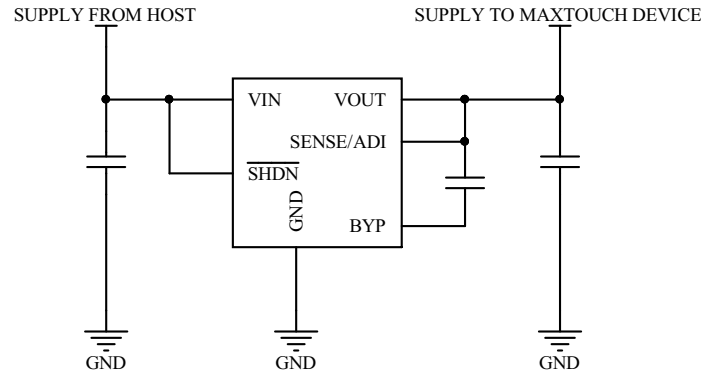

An LDO regulator should be chosen that provides adequate output capability, low noise, no-load stability, good load regulation and step response. The mXT448UD-CCUBHA1 has been qualified for use only with the Microchip LDOs listed in Table 10-1. However, some alternative LDOs with similar specifications are listed in Table 10-2. Microchip has not tested this maXTouch controller with any of these alternative LDOs. Microchip cannot guarantee the functionality or performance of this maXTouch controller with these or any other LDO besides those listed in Table 10-1.

NOTE Microchip recommends that a minimum of a 1.0 μF ceramic, low ESR capacitor at the input and output of these devices is always used. The datasheet for the device should always be referred to when selecting capacitors and the typical recommended values, types and dielectrics adhered to.

Sufficient output capacitance should be provided such that the output rate of rise is compatible with the mXT448UD-CCUBHA1 power rail specifications (see Section 13.2.1 “DC Characteristics”). This can be achieved by a combination of output capacitance on the pins of the LDO and bulk capacitance at the inputs to the mXT448UD-CCUBHA1.

TABLE 10-1: LDO REGULATORS – QUALIFIED FOR USE

Manufacturer	Device	Current Rating (mA)
Microchip Technology Inc.	MCP1824	300
Microchip Technology Inc.	MCP1824S	300
Microchip Technology Inc.	MAQ5300	300
Microchip Technology Inc.	MIC5504	300
Microchip Technology Inc.	MCP1725	500
Microchip Technology Inc.	MIC5514	300
Microchip Technology Inc.	MIC5323	300

TABLE 10-2: LDO REGULATORS – OTHER DEVICES

Manufacturer	Device	Current Rating (mA)
Analog Devices	ADP122/ADP123	300
Diodes Inc.	AP2125	300
Diodes Inc.	AP7335	300

mXT448UD-CCUBHA1 1.0

TABLE 10-2: LDO REGULATORS – OTHER DEVICES (CONTINUED)

Manufacturer	Device	Current Rating (mA)
Linear Technology	LT1763CS8-3.3	500
NXP	LD6836	300
Texas Instruments	LP3981	300

10.3.6 SINGLE SUPPLY OPERATION

When designing a PCB for an application using a single LDO, extra care should be taken to ensure short, low inductance traces between the supply and the touch controller supply input pins. Ideally, tracking for the individual supplies should be arranged in a star configuration, with the LDO at the junction of the star. This will ensure that supply current variations or noise in one supply rail will have minimum effect on the other supplies. In applications where a ground plane is not practical, this same star layout should also apply to the power supply ground returns.

Only regulators with a 300 mA or greater rating can be used in a single-supply design.

Refer to the following application note for more information:

- Application Note: MXTAN0208 – *Design Guide for PCB Layouts for maXTouch Touch Controllers*

10.3.7 MULTIPLE VOLTAGE REGULATOR SUPPLY

The AVdd supply stability is critical for the device because this supply interacts directly with the analog front end. If noise problems exist when using a single LDO regulator, Microchip recommends that AVdd is supplied by a regulator that is separate from the digital supply. This reduces the amount of noise injected into the sensitive, low signal level parts of the design.

10.4 Driven Shield Line

The driven shield line is used to provide a guard track around the touchscreen panel that serves as Ground in mutual capacitance operation and as a driven shield in self capacitance operation.

The guard track must be routed between the groups of X tracks and the groups of Y tracks, as well as between the combined group of X/Y tracks and Ground. It should be fairly wide to avoid X-to-Y coupling in mutual capacitance operation, as the guard track will act as Ground in this circumstance.

A guard track is also needed between any self capacitance X/Y lines and mutual capacitance only X/Y lines (for example, between Multiple Touch Touchscreen T100 and Key Array T15 lines).

FIGURE 10-2: EXAMPLE DRIVEN SHIELD ROUTING

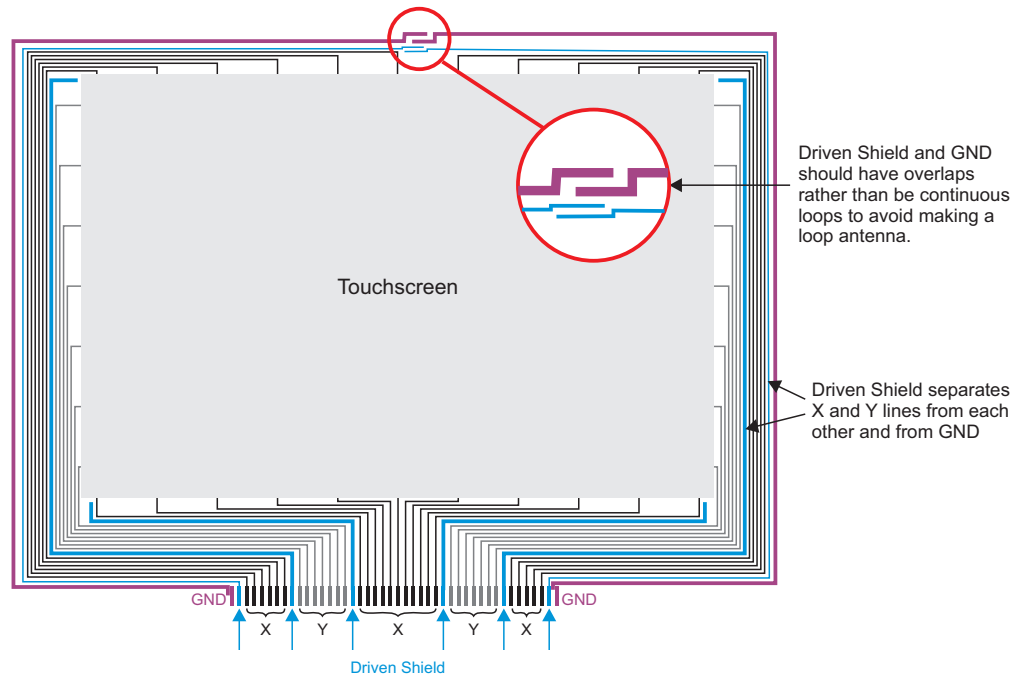

NOTE: Sample touchscreen for illustrative purposes only. The number of X/Y lines available on any given device might differ from that shown here. Similarly, the routing of the X/Y lines shown should not be taken as indicative of any preferred layout and the user's layout may vary.

10.5 ESD Ground Routing

To avoid damage due to ESD strikes, the outermost track on the sensor should be an ESD ground (see [Figure 10-2](#)). Like the driven shield, this should completely surround the sensor but with an overlap at the top rather than forming a complete loop.

To avoid electromagnetic induction of currents into the driven shield trace, a minimum separation of 0.3 mm should be maintained between the ESD GND trace and the Driven Shield.

The ESD ground traces should be connected to a dedicated ground trace in the PCB, and routed such that ESD strike currents do not flow under or close to the touch controller or the connecting wiring between it and the touchscreen array. The ESD ground should be connected in to the main system ground at a star point at the main GND connection to the PCB.

See also:

- MXTAN0208 – *Design guide for PCB Layouts for maXTouch Touch Controllers*

10.6 Analog I/O

In general, tracking for the analog I/O signals from the device should be kept as short as possible. These normally go to a connector which interfaces directly to the touchscreen.

Ensure that adequate ground-planes are used. An analog ground plane should be used in addition to a digital one. Care should be taken to ensure that both ground planes are kept separate and are connected together only at the point of entry for the power to the PCB. This is usually at the input connector.

10.7 Component Placement and Tracking

It is important to orient all devices so that the tracking for important signals (such as power and clocks) are kept as short as possible.

mXT448UD-CCUBHA1 1.0

10.7.1 DIGITAL SIGNALS

In general, when tracking digital signals, it is advisable to avoid sharp directional changes on sensitive signal tracks (such as analog I/O) and any clock or crystal tracking.

A good ground return path for all signals should be provided, where possible, to ensure that there are no discontinuities.

10.8 EMC and Other Observations

The following recommendations are not mandatory, but may help in situations where particularly difficult EMC or other problems are present:

- Try to keep as many signals as possible on the inside layers of the board. If suitable ground flood fills are used on the top and bottom layers, these will provide a good level of screening for noisy signals, both into and out of the PCB.
- Ensure that the on-board regulators have sufficient tracking around and underneath the devices to act as a heatsink. This heatsink will normally be connected to the 0 V or ground supply pin. Increasing the width of the copper tracking to any of the device pins will aid in removing heat. There should be no solder mask over the copper track underneath the body of the regulators.
- Ensure that the decoupling capacitors, especially high capacity ceramic type, have the requisite low ESR, ESL and good stability/temperature properties. Refer to the regulator manufacturer's datasheet for more information.

11.0 GETTING STARTED WITH MXT448UD-CCUBHA1

11.1 Establishing Contact

11.1.1 COMMUNICATION WITH THE HOST

A host can use any of the following interfaces to communicate with the device (See [Section 7.0 “Host Communications”](#)):

- I²C interface (see [Section 8.0 “I2C Communications”](#))
- SPI interface (see [Section 9.0 “SPI Communications”](#))

NOTE The host must always be connected to the device using the primary I²C interface.

11.1.2 POWER-UP SEQUENCE

The power-up sequence is as follows:

After the device has reset, it asserts the $\overline{\text{CHG_I2C}}$ line and $\overline{\text{CHG_SPI}}$ line (if configured for use) to signal to the host that a message is available on the corresponding interface.

1. On power-up, the $\overline{\text{CHG_I2C}}$ line and $\overline{\text{CHG_SPI}}$ line (if configured for use) go low to indicate that there is new data to be read from the device. If the $\overline{\text{CHG_I2C}}$ or $\overline{\text{CHG_SPI}}$ line does not go low within a suitable timeout, there is a problem with the device. The timeout should be chosen to be, for example, three times the relevant typical values for the system as defined in [Section 13.6.3 “Reset Timings”](#) (for example, 1300 ms if all POST tests are performed).
2. Once the $\overline{\text{CHG_I2C}}$ and $\overline{\text{CHG_SPI}}$ lines go low, the host should attempt to read the first 7 bytes of memory from location 0x0000 to establish that the device is present and running following power-up. These bytes represent the ID Information portion of the Information Block and should be recorded by the host so it can read the Object Table (see [Section 11.2 “Using the Object-based Protocol”](#)).
3. The device performs a checksum on the configuration settings held in the non-volatile memory. If the checksum does not match a stored copy of the last checksum, then this indicates that the settings have become corrupted. For compliance with UL/IEC 60730 Class B, the host should make the system safe if the read checksum does not match the expected checksum, or if the configuration error bit in the message data from the Command Processor T6 object is set.

Once the device has been initialized, the host must perform the following initialization so that it can communicate with the device:

1. Read the start positions of all the objects in the device from the Object Table and build up a list of these addresses. Note that the number of elements was read by the host at start-up as part of the ID Information bytes.
2. Use the Object Table to calculate the report IDs so that messages from the device can be correctly interpreted.
3. Read any pending messages generated during the start-up process.

Refer to Application Note MXTAN0213, *Interfacing with maXTouch Touchscreen Controllers*, for more information.

11.2 Using the Object-based Protocol

The device has an object-based protocol (OBP) that is used to communicate with the device. Typical communication includes configuring the device, sending commands to the device, and receiving messages from the device.

11.2.1 CLASSES OF OBJECTS

The mXT448UD-CCUBHA1 contains the following classes of objects:

- **Debug objects** – provide a raw data output method for development and testing.
- **General objects** – required for global configuration, transmitting messages and receiving commands.
- **Touch objects** – operate on measured signals from the touch sensor and report touch data.
- **Signal processing objects** – process data from other objects (typically signal filtering operations).
- **Support objects** – provide additional functionality on the device.

mXT448UD-CCUBHA1 1.0

11.2.2 OBJECT INSTANCES

TABLE 11-1: OBJECTS ON THE MXT448UD-CCUBHA1

Object	Description	Number of Instances	Usage
Debug Objects			
Diagnostic Debug T37	Allows access to diagnostic debug data to aid development.	1	Debug commands only; Read-only object. No configuration or tuning necessary. Not for use in production.
General Objects			
Message Processor T5	Handles the transmission of messages. This object holds a message in its memory space for the host to read.	1	No configuration necessary.
Command Processor T6	Performs a command when written to. Commands include reset, calibrate and backup settings.	1	No configuration necessary.
Power Configuration T7	Controls the sleep mode of the device. Power consumption can be lowered by controlling the acquisition frequency and the sleep time between acquisitions.	1	Must be configured before use.
Acquisition Configuration T8	Controls how the device takes each capacitive measurement.	1	Must be configured before use.
Touch Objects			
Key Array T15	Defines a rectangular array of keys. A Key Array T15 object reports simple on/off touch information.	1	Enable and configure as required.
Multiple Touch Touchscreen T100	Creates a touchscreen that supports the tracking of more than one touch.	1	Enable and configure as required.
Signal Processing Objects			
Key Thresholds T14	Allows different thresholds to be specified for each key in a Key Array.	1	Configure as required.
Key ID Configuration T16	Controls the reporting of Key Array T15 keys.	1	Enable and configure as required.
One-touch Gesture Processor T24	Operates on the data from a Touchscreen object. A One-touch Gesture Processor T24 converts touches into one-touch finger gestures (for example, taps, double taps and drags).	1	Enable and configure as required.
Two-touch Gesture Processor T27	Operates on the data from a One-touch Gesture Processor T24 object. A Two-touch Gesture Processor T27 converts touches into two-touch finger gestures (for example, pinches, stretches and rotates).	1	Enable and configure as required.
Grip Suppression T40	Suppresses false detections caused, for example, by the user gripping the edge of a touchscreen.	1	Enable and configure as required.
Touch Suppression T42	Suppresses false detections caused by unintentional large touches by the user.	1	Enable and configure as required.
Passive Stylus T47	Processes passive stylus input.	1	Enable and configure as required.
Shieldless T56	Allows a sensor to use true single-layer coplanar construction.	1	Enable and configure as required.

TABLE 11-1: OBJECTS ON THE MXT448UD-CCUBHA1 (CONTINUED)

Object	Description	Number of Instances	Usage
Lens Bending T65	Compensates for lens deformation (lens bending) by attempting to eliminate the disturbance signal from the reported deltas.	3	Enable and configure as required.
Noise Suppression T72	Performs various noise reduction techniques during sensor signal acquisition.	1	Enable and configure as required.
Glove Detection T78	Allows for the reporting of glove touches.	1	Enable and configure as required.
Retransmission Compensation T80	Limits the negative effects on touch signals caused by poor device coupling to ground or moisture on the sensor.	1	Enable and configure as required.
Self Capacitance Noise Suppression T108	Suppresses the effects of external noise within the context of self capacitance touch measurements.	1	Enable and configure as required.
Self Capacitance Grip Suppression T112	Allows touches to be reported from the self capacitance measurements while the device is being gripped.	1	Enable and configure as required.
Ignore Nodes T141	Defines a set of sensor nodes that are to be excluded from normal processing.	32	Configure as required
Support Objects			
Self Test Control T10	Controls the self-test routines to find faults on the device.	1	Enable and configure as required.
Self Test Pin Faults T11	Specifies the configuration settings for the Pin Fault self tests.	1	Configure as required.
Self Test Signal Limits T12	Specifies the configuration settings for the Signal Limit self tests.	2	Configure as required.
Communications Configuration T18	Configures additional communications behavior for the device.	2	Check and configure as necessary.
GPIO Configuration T19	Allows the host controller to configure and use the general purpose I/O pins on the device.	1	Enable and configure as required.
User Data T38	Provides a data storage area for user data.	1	Configure as required.
CTE Configuration T46	Controls the capacitive touch engine for the device.	1	Must be configured.
Timer T61	Provides control of a timer.	6	Enable and configure as required.
Dynamic Configuration Controller T70	Allows rules to be defined that respond to system events.	20	Enable and configure as required.
Dynamic Configuration Container T71	Allows the storage of user configuration on the device that can be selected at runtime based on rules defined in the Dynamic Configuration Controller T70 object.	1	Configure if Dynamic Configuration Controller T70 is in use.
Touch Event Trigger T79	Configures touch triggers for use with the event handler.	3	Enable and configure as required.
Auxiliary Touch Configuration T104	Allows the setting of self capacitance gain and thresholds for a particular measurement to generate auxiliary touch data for use by other objects.	1	Enable and configure if using self capacitance measurements
Self Capacitance Global Configuration T109	Provides configuration for self capacitance measurements employed on the device.	1	Check and configure as required (if using self capacitance measurements).

mXT448UD-CCUBHA1 1.0

TABLE 11-1: OBJECTS ON THE MXT448UD-CCUBHA1 (CONTINUED)

Object	Description	Number of Instances	Usage
Self Capacitance Tuning Parameters T110	Provides configuration space for a generic set of settings for self capacitance measurements.	12	Use under the guidance of Microchip field engineers only.
Self Capacitance Configuration T111	Provides configuration for self capacitance measurements employed on the device.	2	Check and configure as required (if using self capacitance measurements).
Self Capacitance Measurement Configuration T113	Configures self capacitance measurements to generate data for use by other objects.	1	Enable and configure as required.
Data Container T117	Provides a mechanism for retrieving specific data held in the device's internal memory.	6	Read-only object. No configuration necessary.
Data Container Controller T118	Provides direct access to internal data in memory for use with the Data Container T117 objects.	1	Enable and configure as required.
Self Capacitance Voltage Modulation T133	Controls the voltage modulation on self capacitance scans.	2	Enable and configure as required.
Message Count T144	Provides a count of pending messages.	1	Read-only object.
Ignore Nodes Controller T145	Specifies how ignored nodes configured in Ignore Nodes T141 are applied to various measurement processes on the device.	1	Configure as required

11.2.3 CONFIGURING AND TUNING THE DEVICE

The objects are designed such that a default value of zero in their fields is a “safe” value that typically disables functionality. The objects must be configured before use and the settings written to the non-volatile memory using the Command Processor T6 object.

Perform the following actions for each object:

1. Enable the object, if the object requires it.
2. Configure the fields in the object, as required.
3. Enable reporting, if the object supports messages, to receive messages from the object.

11.3 Writing to the Device

The following mechanisms can be used to write to the device:

- Using an I²C write operation (see [Section 8.2 “Writing To the Device”](#)).
- Using the SPI write operation (see [Section 9.3 “Write Operation and Responses”](#)).

For compliance with UL/IEC 60730 Class B, all writes on the I²C interface (not SPI) must include a sequence number and the host should take appropriate action if the device detects an out-of-sequence write. In addition, the host must calculate a CRC on the data sent to the device. Refer to the *mXT640UD-CCUBHA1 1.0 Family UL/IEC 60730 Class B Compliance Guide* for full details.

Communication with the device is achieved by writing to the appropriate object:

- To send a command to the device, an appropriate command is written to the Command Processor T6 object.
- To configure the device, a configuration parameter is written to the appropriate object. For example, writing to the Power Configuration T7 configures the power consumption for the device and writing to the Multiple Touch Touchscreen T100 object sets up the touchscreen. Some objects are optional and need to be enabled before use.

IMPORTANT! When the host issues any command within an object that results in a flash write to the device Non-Volatile Memory (NVM), that object should have its CTRL RPTEN bit set to 1, if it has one. This ensures that a message from the object writing to the NVM is generated at the completion of the process and an assertion of the $\overline{\text{CHG_I2C}}$ or $\overline{\text{CHG_SPI}}$ line is executed.

The host must also ensure that the assertion of the $\overline{\text{CHG_I2C}}$ or $\overline{\text{CHG_SPI}}$ line refers to the expected object report ID before asserting the RESET line to perform a reset. Failure to follow this guidance may result in a corruption of device configuration area and the generation of a CFGERR.

11.3.1 WRITING A CONFIGURATION TO THE DEVICE

During a configuration download, device operation may be based upon only part of that configuration because it is yet to finish downloading. In rare circumstances, the total processing time might exceed the WDT reset time. This is more likely to happen when measurements take a long time to perform due to the partial configuration.

To ensure that the configuration is written safely, follow these steps:

1. Set Power Configuration T7 IDLEACQINT and ACTVACQINT to 0 (that is, deep sleep) as a temporary measure.
2. Download the rest of the configuration, except those Power Configuration T7 controls.
3. Finally, set the Power Configuration T7 acquisition interval controls to the required values.

11.4 Reading from the Device

Status information is stored in the Message Processor T5 object. This object can be read to receive any status information from the device. Each message includes a sequence number and a CRC for error detection. For compliance with UL/IEC 60730 Class B, the host should monitor the sequence number and take appropriate action if it detects a missing or repeated message, or if a message is received out of sequence.

The following mechanisms provide an interrupt-style interface for reading messages in the Message Processor T5 object:

- In I²C and SPI modes, the $\overline{\text{CHG_I2C}}$ or $\overline{\text{CHG_SPI}}$ line is asserted whenever a new message is available in the Message Processor T5 object (see [Section 8.4 “CHG_I2C Line”](#) and [Section 9.2.1 “CHG_SPI Line”](#)). See [Section 8.3 “Reading From the Device”](#) for information on the format of the I²C read operation and [Section 9.4 “Read Operation and Responses”](#) for information on the format of the SPI read operation.

Note that, when using the SPI interface, two SPI transactions must take place: the first is an SPI Read request, and the second is a response that actually contains the data in its payload (see [Section 9.4 “Read Operation and Responses”](#)).

NOTE The host should always wait to be notified of messages; the host should not poll the device for messages (either by polling the Message Processor T5 object or by polling the $\overline{\text{CHG_I2C}}$ or $\overline{\text{CHG_SPI}}$ line).

mXT448UD-CCUBHA1 1.0

12.0 DEBUGGING AND TUNING

12.1 Hardware Debug Interface

The Hardware Debug Interface is used for tuning and debugging when running the system and allows the development engineer to use Microchip maXTouch Studio to read the real-time raw data. This uses the low-level debug port.

NOTE The host must not use the Command Processor T6 debug port over the Hardware Debug Interface during UL/IEC 60730 Class B operation as use of the Hardware Debug Interface is not UL/IEC 60730 Class B compliant.

The Hardware Debug Interface consists of the DBG_CLK and DBG_DATA lines. These lines should be routed to test points on all designs such that they can be connected to external hardware during system development. These lines should not be connected to power or GND. See [Section 2.2.11 “Hardware Debug Interface”](#) for more details.

The Hardware Debug Interface is enabled by the Command Processor T6 object and by default will be off.

NOTE When the DBG_CLK and DBG_DATA lines are in use for debugging, any alternative function for the pins cannot be used. The touch controller will take care of the pin configuration.

12.2 Object-based Protocol

The device provides a mechanism for obtaining debug data for development and testing purposes by reading data from the Diagnostic Debug T37 object.

NOTE The Diagnostic Debug T37 object is of most use for simple tuning purposes. When debugging a design, it is preferable to use the Hardware Debug Interface, as this will have a much higher bandwidth and can provide real-time data.

12.3 Self Test

The Self Test Control T10, Self Test Pin Faults T11 and Self Test Signal Limits T12 objects run self-test routines in the device to find hardware faults in the device both at power-on/reset and during normal operation. These self-test routines can be configured to check the CPU, clock, memory and power supplies of the devices, as well as CTE operation and the signal levels. The tests can also check for pin shorts between sensor X and Y pins, and between the sensor lines and DS0, power or GND pins. In addition, an open DS0 pin can be detected.

The Self Test Control T10 object can also provide continuous monitoring of the health of the device while it is in operation. A periodic Built-In Self Test (BIST) test can be run at a user-specified interval and reports the global pass and specific fail messages (as determined by the device configuration). Reporting is achieved either by standard Self Test Control T10 object protocol messages or by a configurable hardware GPIO pin, configured using the GPIO Configuration T19 object.

IMPORTANT! For compliance with UL/IEC 60730 Class B, reporting should be achieved using Self Test Control T10 object protocol messages and not by a hardware GPIO pin.

For a list of the self tests available on the mXT448UD-CCUBHA1, see [Table 12-1](#).

TABLE 12-1: SELF TESTS

Self Test Group	Run as...		
	Pre-Operation Self Test (POST)	Built-In Self Test (BIST)	On Demand Test
CPU	Automatically tested at start-up	Yes	–
Internal Interrupts	Yes	Yes	–
Clock	Yes	Yes	–
Flash Memory	Yes	Yes	–
RAM	CTE RAM: Yes AVR RAM: Automatically tested at start-up	Yes	–
Power	Yes	Yes	Yes
CTE (Capacitive Touch Engine)	Yes	Yes	–
Pin Faults	Yes	Yes	Yes
Signal Limits ⁽¹⁾	Yes	Yes	Yes

Internal System

CTE and Touch System

Note 1: If the Driven Shield Signal Limit test is enabled in Self Test Signal Limits T12, the Signal Limit tests include additional tests on the Driven Shield (DS0) pin.

mXT448UD-CCUBHA1 1.0

13.0 SPECIFICATIONS

13.1 Absolute Maximum Specifications

Vdd	3.6V
VddIO	3.6V
AVdd	3.6V
Maximum continuous combined pin current, all GPIO _n pins	40 mA
Voltage forced onto any pin	-0.3 V to (Vdd, VddIO or AVdd) + 0.3 V
Configuration parameters maximum writes	10,000
Maximum junction temperature	125°C

CAUTION! Stresses beyond those listed under *Absolute Maximum Specifications* may cause permanent damage to the device. This is a stress rating only and functional operation of the device at these or other conditions beyond those indicated in the operational sections of this specification is not implied. Exposure to absolute maximum specification conditions for extended periods may affect device reliability.

13.2 Recommended Operating Conditions

Operating temperature	-40°C to +105°C
Storage temperature	-60°C to +150°C
Vdd	3.3 V ±5%
VddIO	1.8 V to 3.3 V
AVdd	3.3 V ±5%
XVdd with internal voltage doubler	2 × Vdd
XVdd with internal voltage tripler	3 × Vdd
Temperature slew rate	10°C/min

13.2.1 DC CHARACTERISTICS

13.2.1.1 Analog Voltage Supply – AVdd

Parameter	Min	Typ	Max	Units	Notes
AVdd					
Operating limits	3.14	3.3	3.47	V	
Supply Rise Rate	–	–	0.25	V/μs	For example, for a 3.3 V rail, the voltage should take a minimum of 13.2 μs to rise

13.2.1.2 Digital Voltage Supply – VddIO, Vdd

Parameter	Min	Typ	Max	Units	Notes
VddIO					
Operating limits	1.71	3.3	3.47	V	
Supply Rise Rate	–	–	0.25	V/μs	For example, for a 3.3 V rail, the voltage should take a minimum of 13.2 μs to rise
Vdd					
Operating limits	3.14	3.3	3.47	V	
Supply Rise Rate	–	–	0.25	V/μs	For example, for a 3.3 V rail, the voltage should take a minimum of 13.2 μs to rise
Supply Fall Rate	–	–	0.05	V/μs	For example, for a 3.3 V rail, the voltage should take a minimum of 66 μs to fall

13.2.1.3 XVdd Voltage Supply – XVdd

Parameter	Min	Typ	Max	Units	Notes
XVdd					
Operating limits – voltage doubler enabled	–	2 × Vdd	–	V	
Operating limits – voltage tripler enabled	–	3 × Vdd	–	V	

13.2.2 POWER SUPPLY RIPPLE AND NOISE

Parameter	Min	Typ	Max	Units	Notes
Vdd	–	–	±50	mV	Across frequency range 1 Hz to 1 MHz
AVdd	–	–	±40	mV	Across frequency range 1 Hz to 1 MHz, with Noise Suppression enabled

mXT448UD-CCUBHA1 1.0

13.3 Test Configuration

The configuration values listed below were used in the reference unit to validate the interfaces and derive the characterization data provided in the following sections.

TABLE 13-1: TEST CONFIGURATION

Object/Parameter	Description/Setting (Numbers in Decimal)
Power Configuration T7	
CFG2	0 (Power Monitor Enabled)
Acquisition Configuration T8	
CHRGTIME	25
MEASALLOW	3
Self Test Control T10	Object Enabled; Reporting Enabled; BIST Reporting Enabled; POST Reporting Enabled
Key Array T15	Object Enabled
XSIZE	1
YSIZE	3
Communications Configuration T18	Object Instance 1 (SPI Interface) Enabled (Section 13.5 "Current Consumption – I²C Primary and SPI Secondary Interfaces" only)
GPIO Configuration T19	Object Enabled
One-touch Gesture Processor T24	Object Enabled
Two-touch Gesture Processor T27	Object Enabled
Touch Suppression T42	Object Enabled
CTE Configuration T46	
IDLESYNCSPERX	8
ACTVSYNCSPERX	8
Passive Stylus T47	Object Enabled
Lens Bending T65 Instance 0	Object Instance Enabled
Lens Bending T65 Instance 1	Object Instance Enabled
Lens Bending T65 Instance 2	Object Instance Enabled
Noise Suppression T72	Object Enabled
Glove Detection T78	Object Enabled
Retransmission Compensation T80	Object Enabled
Multiple Touch Touchscreen T100	Object Enabled; Reporting Enabled
XSIZE	32
Auxiliary Touch Configuration T104	Object Enabled
Self Capacitance Noise Suppression T108	Object Enabled
Self Capacitance Configuration T111 Instance 0	
INTTIME	50
IDLESYNCSPERL	12
ACTVSYNCSPERL	12
Self Capacitance Configuration T111 Instance 1	
INTTIME	50
IDLESYNCSPERL	12
ACTVSYNCSPERL	12

13.4 Current Consumption – I²C Interface Only

NOTE The characterization charts show typical values based on the configuration in [Table 13-1](#). Actual power consumption in the user’s application will depend on the circumstances of that particular project and will vary from that shown here. Further tuning will be required to achieve an optimal performance.

13.4.1 AVDD

Acquisition Rate (ms)	Current Consumption (mA)				
	0 Touches	1 Touch	2 Touches	5 Touches	10 Touches
Free-run	9.5	8.2	8.2	7.6	7.2
10	7	6.4	6.4	6.5	6.5
16	4.4	4	4.1	4	4.1
32	2.2	2	2.1	2	2.1
64	1.1	1	1	1	1
128	0.7	0.6	0.6	0.6	0.6
254	0.3	0.3	0.3	0.3	0.3

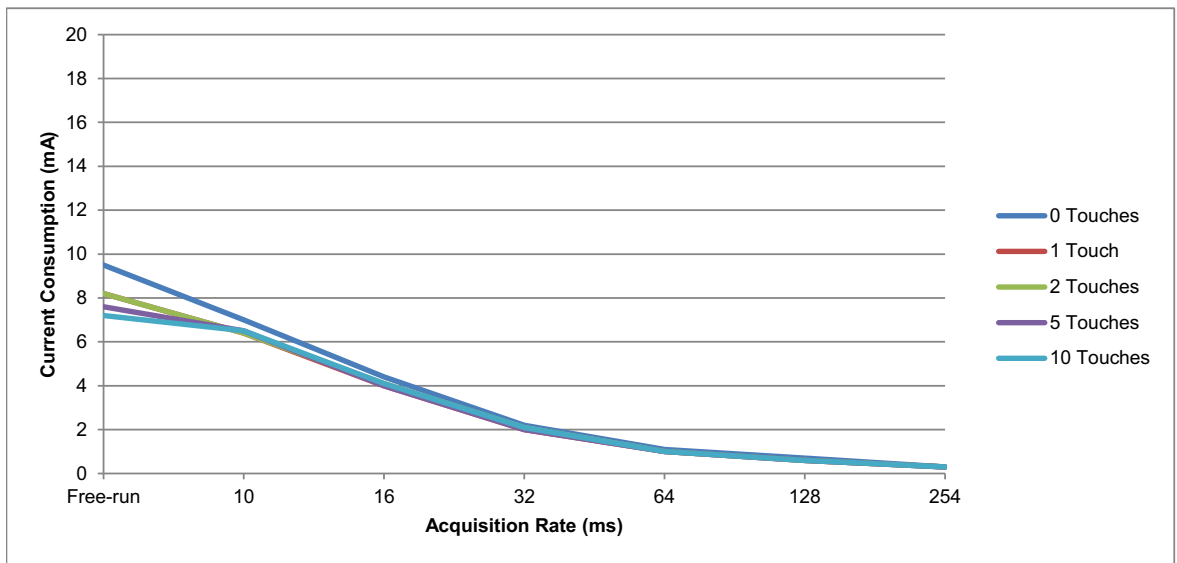

mXT448UD-CCUBHA1 1.0

13.4.2 VDD

Acquisition Rate (ms)	Current Consumption (mA)				
	0 Touches	1 Touch	2 Touches	5 Touches	10 Touches
Free-run	8.3	8.8	9.1	9.8	10.8
10	6.2	7.1	7.4	8.7	9.8
16	4	4.5	4.7	5.4	6.1
32	2.1	2.4	2.5	2.8	3.2
64	1.2	1.3	1.4	1.6	1.8
128	0.8	0.8	0.8	0.9	1
254	0.5	0.5	0.5	0.6	0.7

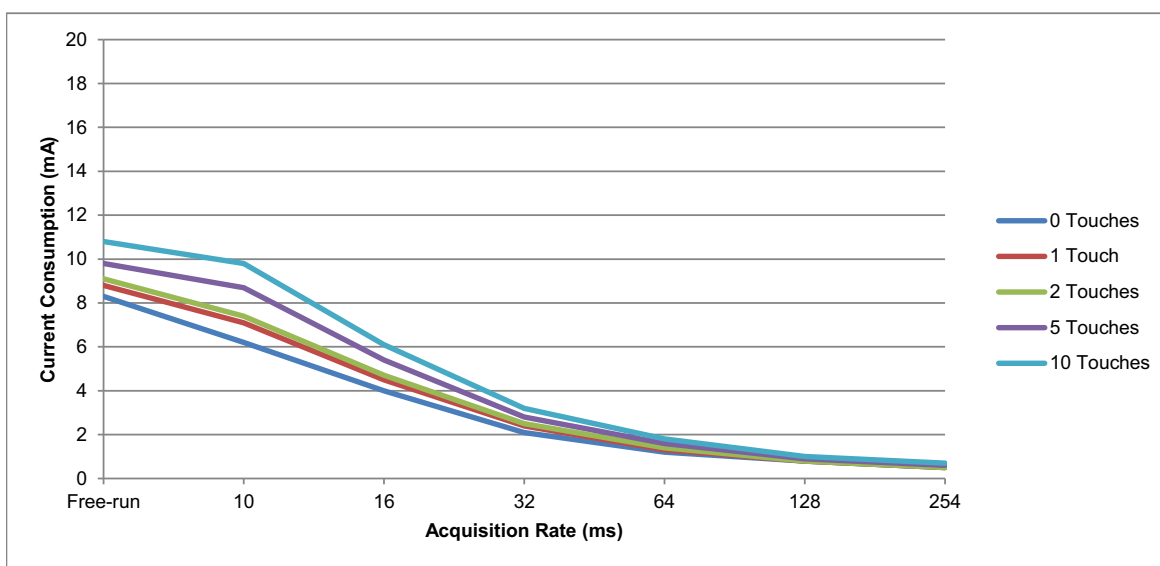

13.4.3 VDDIO

Acquisition Rate (ms)	Current Consumption (mA)				
	0 Touches	1 Touch	2 Touches	5 Touches	10 Touches
Free-run	0.20	0.30	0.30	0.50	0.70
10	0.20	0.30	0.30	0.40	0.60
16	0.20	0.20	0.30	0.40	0.50
32	0.20	0.20	0.30	0.30	0.30
64	0.20	0.20	0.20	0.30	0.30
128	0.20	0.20	0.20	0.20	0.20
254	0.20	0.20	0.20	0.20	0.20

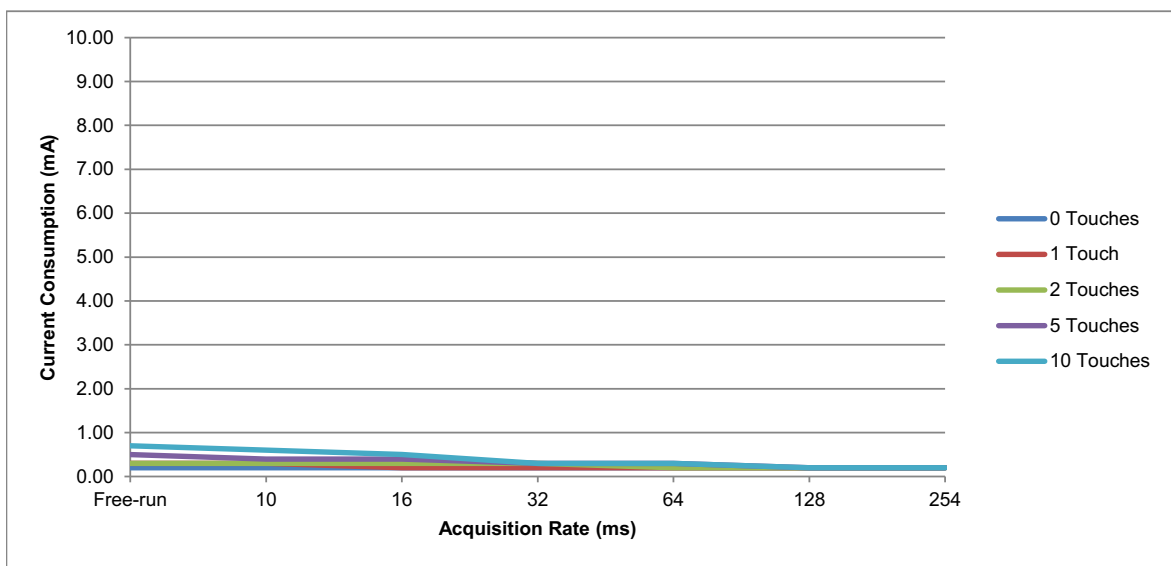

13.4.4 DEEP SLEEP

Power Monitor On; $T_A = 25^\circ\text{C}$

Parameter	Value	Units	Notes
Deep Sleep Current	0.4	mA	Vdd = 3.3V, AVdd = 3.3V, VddIO = 3.3V
Deep Sleep Power	1.4	mW	

Power Monitor Off; $T_A = 25^\circ\text{C}$

Parameter	Value	Units	Notes
Deep Sleep Current	0.2	mA	Vdd = 3.3V, AVdd = 3.3V, VddIO = 3.3V
Deep Sleep Power	0.8	mW	

mXT448UD-CCUBHA1 1.0

13.5 Current Consumption – I²C Primary and SPI Secondary Interfaces

NOTE The characterization charts show typical values based on the configuration in [Table 13-1 on page 54](#). Actual power consumption in the user's application will depend on the circumstances of that particular project and will vary from that shown here. Further tuning will be required to achieve an optimal performance.

13.5.1 AVDD

Acquisition Rate (ms)	Current Consumption (mA)				
	0 Touches	1 Touch	2 Touches	5 Touches	10 Touches
Free-run	8.6	7.8	7.6	6.8	5.1
10	7	6.4	6.4	6.5	5.1
16	4.4	4	4	4	4
32	2.2	2	2	2	2.1
64	1.2	1.1	1.1	1.1	1.1
100	0.8	0.7	0.7	0.7	0.7
128	0.6	0.6	0.6	0.6	0.6
254	0.3	0.3	0.3	0.3	0.3

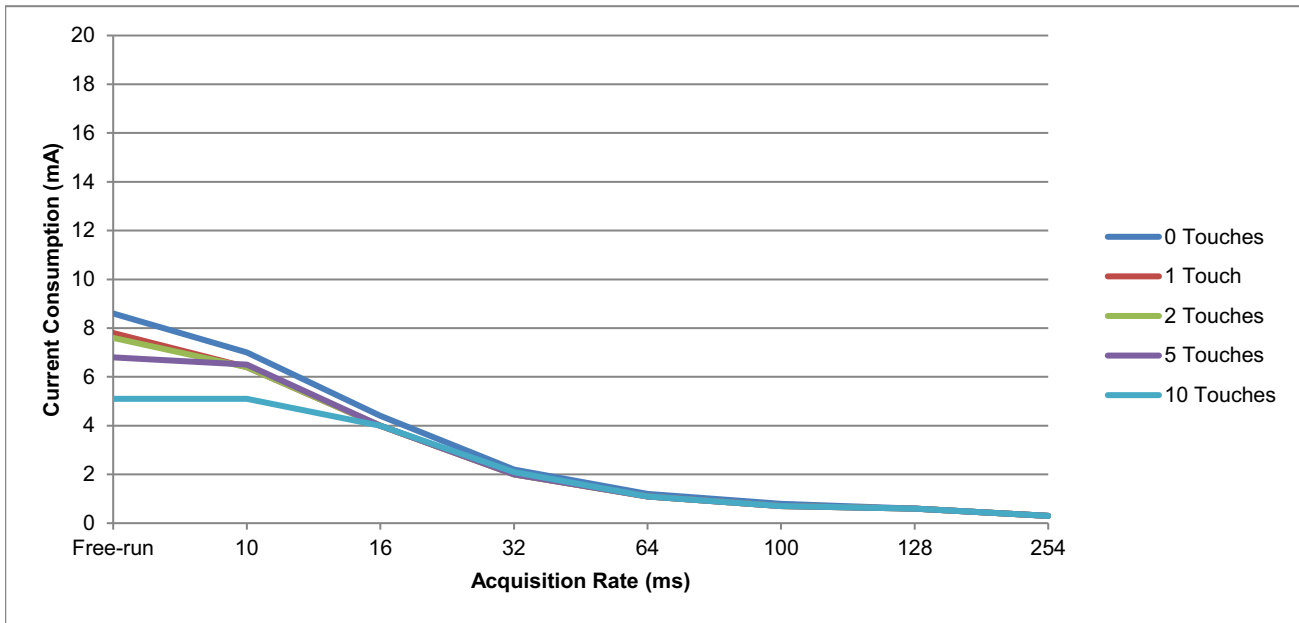

13.5.2 VDD

Acquisition Rate (ms)	Current Consumption (mA)				
	0 Touches	1 Touch	2 Touches	5 Touches	10 Touches
Free-run	8.2	9	9.6	10.5	10.2
10	7.5	8.2	8.8	10.2	10.1
16	6.2	6.7	7.1	7.9	9.1
32	5.2	5.4	5.6	6	6.7
64	4.7	4.8	4.9	5.1	5.5
100	4.5	4.6	4.6	4.8	5
128	4.4	4.5	4.5	4.7	4.8
254	4.3	4.3	4.3	4.4	4.5

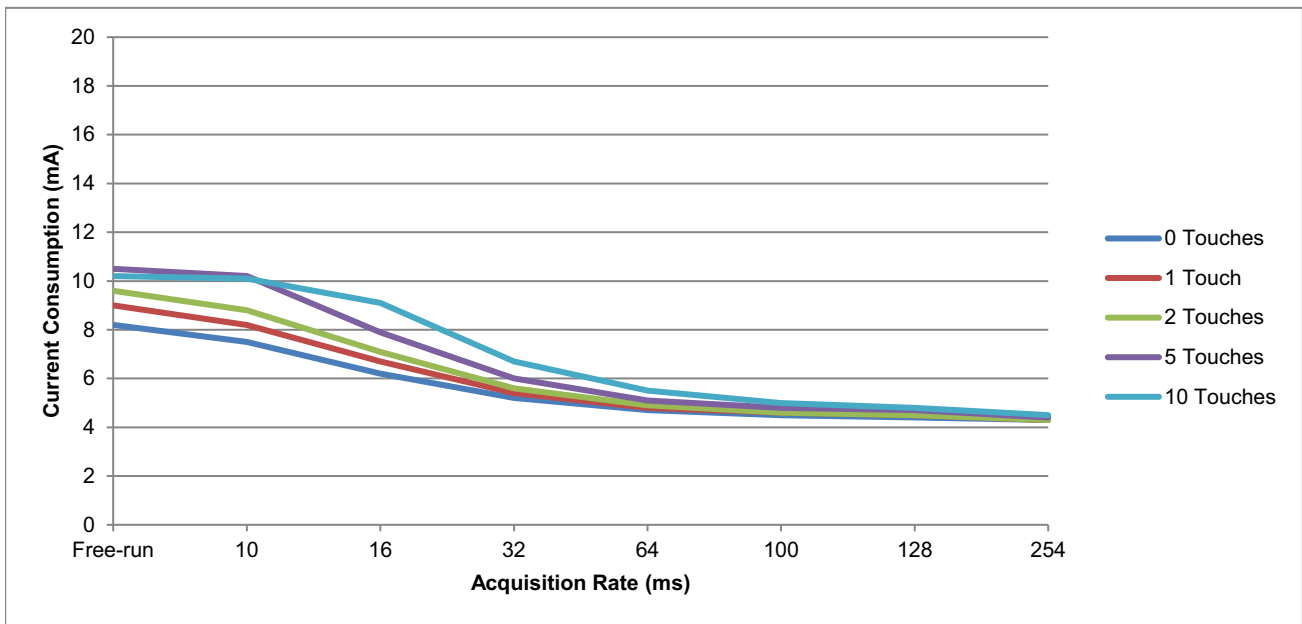

mXT448UD-CCUBHA1 1.0

13.5.3 VDDIO

Acquisition Rate (ms)	Current Consumption (mA)				
	0 Touches	1 Touch	2 Touches	5 Touches	10 Touches
Free-run	0.09	0.17	0.29	0.60	0.90
10	0.09	0.16	0.27	0.57	0.89
16	0.10	0.10	0.20	0.38	0.75
32	0.08	0.09	0.12	0.24	0.40
64	0.10	0.06	0.10	0.15	0.24
100	0.05	0.06	0.05	0.12	0.17
128	0.09	0.06	0.06	0.10	0.14
254	0.09	0.06	0.07	0.07	0.11

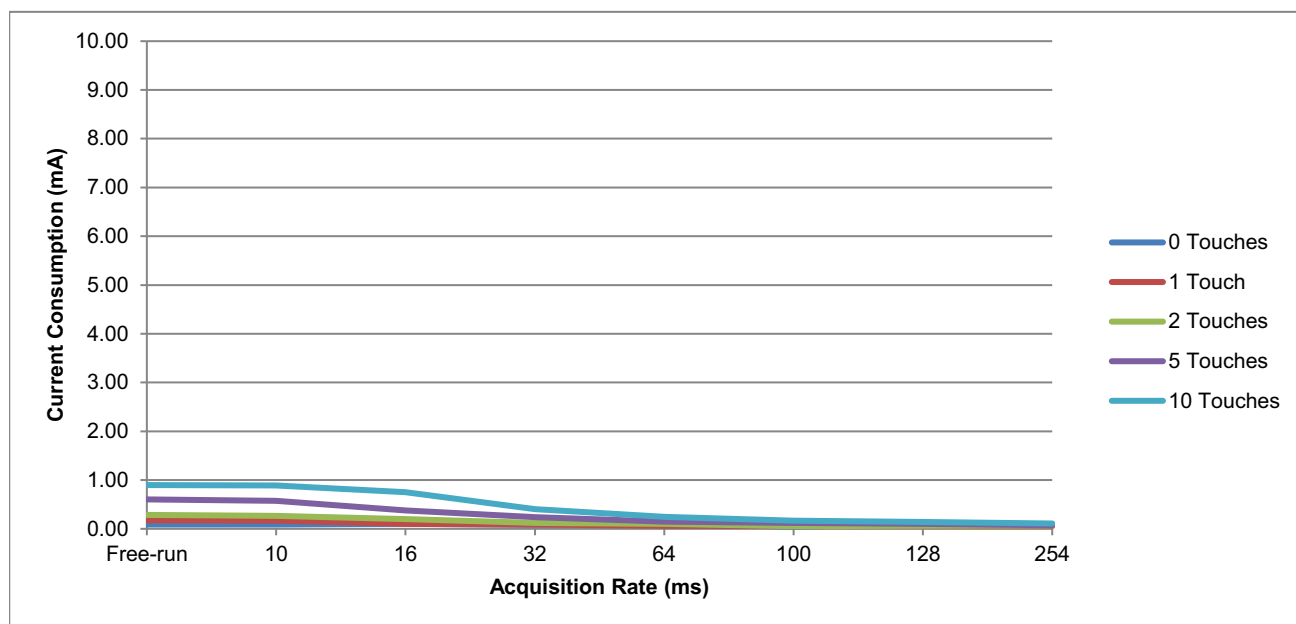

13.5.4 DEEP SLEEP

Power Monitor On; $T_A = 25^\circ\text{C}$

Parameter	Value	Units	Notes
Deep Sleep Current	3.9	mA	Vdd = 3.3V, AVdd = 3.3V, VddIO = 3.3V
Deep Sleep Power	13.0	mW	

Power Monitor Off; $T_A = 25^\circ\text{C}$

Parameter	Value	Units	Notes
Deep Sleep Current	3.7	mA	Vdd = 3.3V, AVdd = 3.3V, VddIO = 3.3V
Deep Sleep Power	12.2	mW	

13.6 Timing Specifications

NOTE The figures below show typical values based on the test configuration. Actual timings in the user's application will depend on the circumstances of that particular project and will vary from those shown below. Further tuning will be required to achieve an optimal performance.

13.6.1 TOUCH LATENCY

Conditions: XSIZE = 32; CHRGTIME = 25; IDLESYNCSPERX = 8; ACTVSYNCSPERX = 8;
 T = ambient temperature; Finger center of screen; Reporting Off except T100 and T10

Idle Primary = Mutual Capacitance; Active Primary = Mutual Capacitance

T100 TCHDIDOWN	Pipelining Off			Pipelining On			Units
	Min	Typ	Max	Min	Typ	Max	
3	29	36	42	30	37	44	ms
2	21	31	41	22	32	42	ms
1	12	22	31	14	24	34	ms
Disabled (DISTCHDIDOWN = 1)	6	11	16	8	13	17	ms

13.6.2 REPORT RATE

Conditions: XSIZE = 32; CHRGTIME = 25; IDLESYNCSPERX = 8; ACTVSYNCSPERX = 8; T = ambient temperature

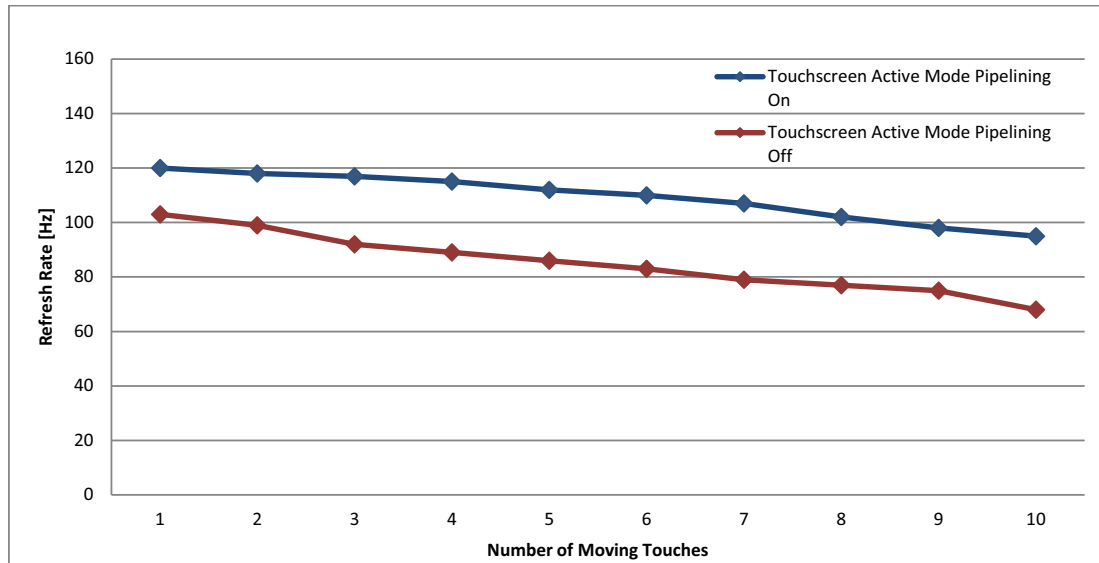

mXT448UD-CCUBHA1 1.0

13.6.3 RESET TIMINGS

Parameter	POST Enabled (Typ)	POST Disabled (Typ)	Units	Notes
Power on to $\overline{\text{CHG_I2C}}$ and $\overline{\text{CHG_SPI}}$ lines low	450	135	ms	Triggered by Vdd supply at start up
Hardware reset to $\overline{\text{CHG_I2C}}$ and $\overline{\text{CHG_SPI}}$ lines low	450	135	ms	Triggered by $\overline{\text{RESET}}$
Software reset to $\overline{\text{CHG_I2C}}$ and $\overline{\text{CHG_SPI}}$ lines low	480	165	ms	Triggered by Command Processor T6 Reset command

Note 1: Any $\overline{\text{CHG_I2C}}$ or $\overline{\text{CHG_SPI}}$ line activity before the power-on or reset period has expired should be ignored by the host. Operation of this signal cannot be guaranteed before the power-on/reset periods have expired.

13.7 Touch Accuracy and Repeatability

Parameter	Min	Typ	Max	Units	Notes
Linearity	–	±0.5	–	mm	Finger diameter 8 mm
Accuracy (across all areas of screen)	–	0.5	–	mm	Finger diameter 8 mm
Repeatability	–	±0.25	–	%	X axis with 12-bit resolution

13.8 Touchscreen Sensor Characteristics

Parameter	Description	Min	Typ	Max	Units	Notes
Cm	Mutual capacitance	0.15	–	10	pF	Assumes XVdd ≥ 2 × AVdd. Minimum is 0.3pF with XVdd = AVdd
Cpx	Self capacitance load to X	–	–	100	pF	Single X line
Cpy	Self capacitance load to Y	–	–	100	pF	Single Y line
ΔCpx	Self capacitance imbalance on X	–	–	9.7	pF	Value increases by 1 pF for every 20 pF reduction in Cpx
ΔCpy	Self capacitance imbalance on Y	–	–	9.7	pF	Value increases by 1 pF for every 20 pF reduction in Cpy
Cpds0	Self capacitance load to Driven Shield	–	–	100	pF	Recommended maximum load on Driven Shield line ⁽¹⁾

Note 1: Please contact your Microchip representative for advice if you intend to use higher values.

13.9 Input/Output Characteristics

Parameter	Description	Min	Typ	Max	Units	Notes
Input (All input pins connected to the VddIO power rail)						
Vil	Low input logic level	–0.3	–	0.3 × VddIO	V	VddIO = 1.8 V to Vdd
Vih	High input logic level	0.7 × VddIO	–	VddIO	V	VddIO = 1.8 V to Vdd
Iil	Input leakage current	–	–	1	μA	Pull-up resistors disabled
$\overline{\text{RESET}}$	Internal pull-up resistor	9	–	18	kΩ	
GPIOs	Internal pull-up/pull-down resistor	20	40	60	kΩ	

Parameter	Description	Min	Typ	Max	Units	Notes
Output (All output pins connected to the VddIO power rail)						
V _{ol}	Low output voltage	0	–	0.2 × V _{ddIO}	V	V _{ddIO} = 1.8 V to V _{dd} I _{ol} = 2 mA
V _{oh}	High output voltage	0.8 × V _{ddIO}	–	V _{ddIO}	V	V _{ddIO} = 1.8 V to V _{dd} I _{oh} = –2 mA

13.10 I²C Specification

Parameter	Value
Address	0x4B
I ² C specification ⁽¹⁾	Revision 6.0
Maximum bus speed (SCL) ⁽²⁾	3.4 MHz
Standard Mode ⁽³⁾	100 kHz
Fast Mode ⁽³⁾	400 kHz
Fast Mode Plus ⁽³⁾	1 MHz
High Speed Mode ⁽³⁾	3.4 MHz

- Note 1:** More detailed information on I²C operation is available from UM10204, *I²C bus specification and user manual*, available from NXP.
- 2:** In systems with heavily laden I²C lines, even with minimum pull-up resistor values, bus speed may be limited by capacitive loading to less than the theoretical maximum.
- 3:** The values of pull-up resistors should be chosen to ensure SCL and SDA rise and fall times meet the I²C specification. The value required will depend on the amount of capacitance loading on the lines.

13.11 SPI Specification

Parameter	Specification
Mode	Mode 3 (CPOL = 1 and CPHA = 1)
Clock idle state	High
Setup on	Leading (falling) edge
Sample on	Trailing (rising) edge
Word size	8-bit
Maximum clock frequency	8 MHz

13.12 Thermal Packaging

13.12.1 THERMAL DATA

Parameter	Description	Typ	Unit	Condition	Package
θ _{JA}	Junction to ambient thermal resistance	51.9	°C/W	Still air	88-ball UFBGA 6 × 6 × 0.6 mm
θ _{JC}	Junction to case thermal resistance	6.5	°C/W		88-ball UFBGA 6 × 6 × 0.6 mm

mXT448UD-CCUBHA1 1.0

13.12.2 JUNCTION TEMPERATURE

The maximum junction temperature allowed on this device is 125°C.

The average junction temperature in °C (T_J) for this device can be obtained from the following:

$$T_J = T_A + (P_D \times \theta_{JA})$$

If a cooling device is required, use this equation:

$$T_J = T_A + (P_D \times (\theta_{HEATSINK} + \theta_{JC}))$$

where:

- θ_{JA} = package thermal resistance, Junction to ambient (°C/W) (see [Section 13.12.1 “Thermal Data”](#))
- θ_{JC} = package thermal resistance, Junction to case thermal resistance (°C/W) (see [Section 13.12.1 “Thermal Data”](#))
- $\theta_{HEATSINK}$ = cooling device thermal resistance (°C/W), provided in the cooling device datasheet
- P_D = device power consumption (W)
- T_A is the ambient temperature (°C)

13.13 ESD Information

Parameter	Value	Reference Standard
Human Body Model (HBM)	±2000V	JEDEC JS-001
Charge Device Model (CDM)	±250V	JEDEC JS-001

13.14 Soldering Profile

Profile Feature	Green Package
Average Ramp-up Rate (217°C to Peak)	3°C/s max
Preheat Temperature 175°C ±25°C	150 – 200°C
Time Maintained Above 217°C	60 – 150 s
Time within 5°C of Actual Peak Temperature	30 s
Peak Temperature Range	260°C
Ramp down Rate	6°C/s max
Time 25°C to Peak Temperature	8 minutes max

13.15 Moisture Sensitivity Level (MSL)

MSL Rating	Package Type(s)	Peak Body Temperature	Specifications
MSL3	88-ball UFBGA	260°C	IPC/JEDEC J-STD-020

14.0 PACKAGING INFORMATION

14.1 Package Marking Information

14.1.1 88-BALL UFBGA

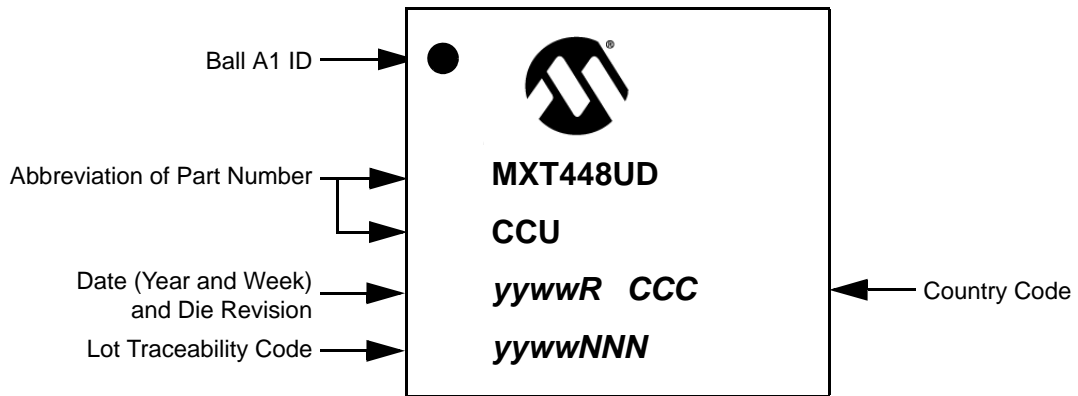

14.1.2 ORDERABLE PART NUMBERS

The product identification system for maXTouch devices is described in ["Product Identification System" on page 73](#). That section also lists example part numbers for the device.

mXT448UD-CCUBHA1 1.0

14.2 Package Details

88-Ball Ultra Thin Fine Pitch Ball Grid Array (BVB) - 6x6x0.6 mm Body [UFBGA] Atmel Legacy Global Package Code CJM

Note: For the most current package drawings, please see the Microchip Packaging Specification located at <http://www.microchip.com/packaging>

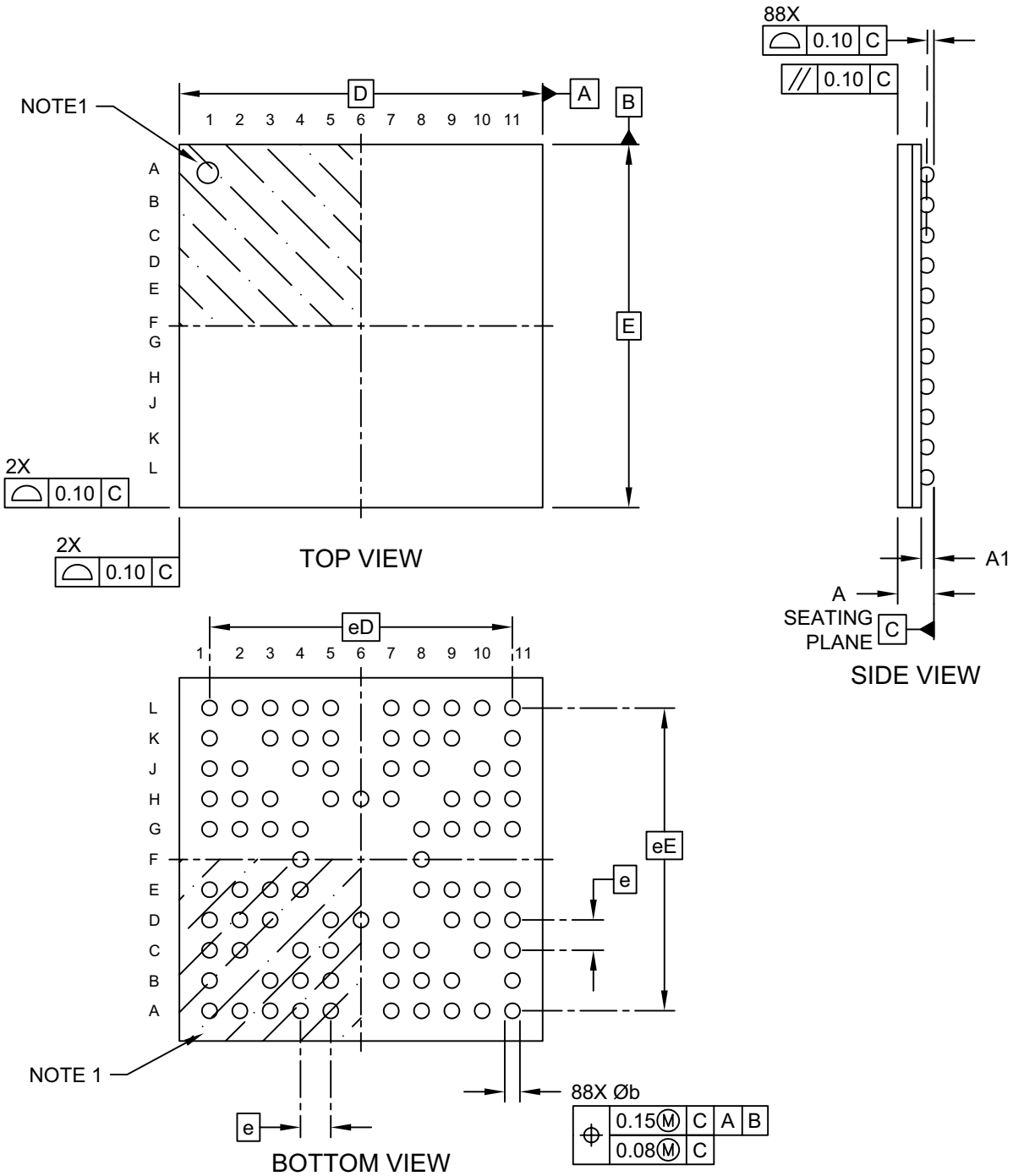

Microchip Technology Drawing C04-21158 Rev A Sheet 1 of 2

**88-Ball Ultra Thin Fine Pitch Ball Grid Array (BVB) - 6x6x0.6 mm Body [UFBGA]
Atmel Legacy Global Package Code CJM**

Note: For the most current package drawings, please see the Microchip Packaging Specification located at <http://www.microchip.com/packaging>

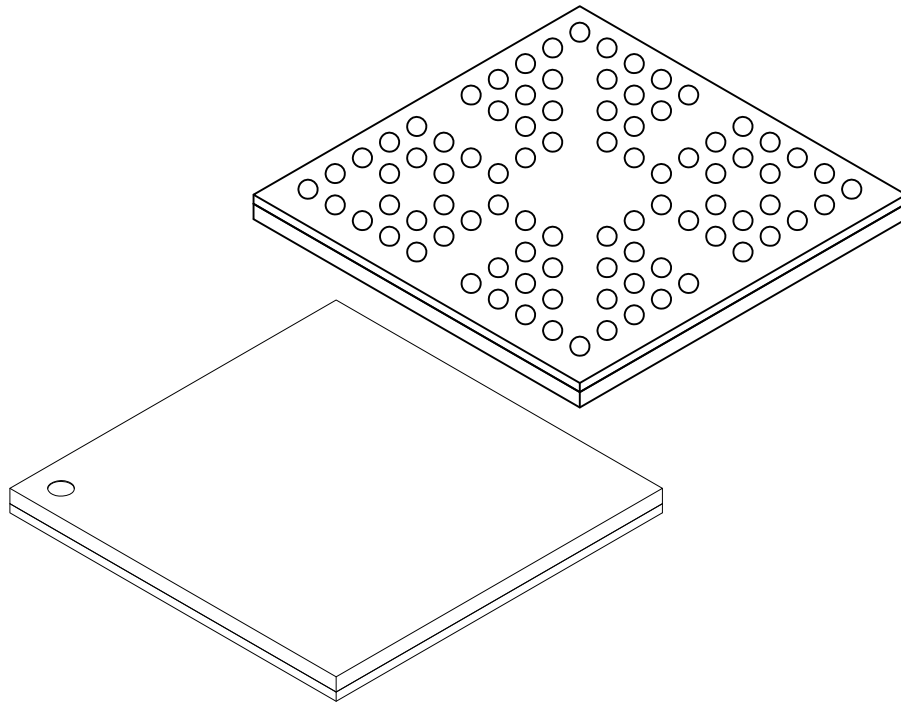

		Units	MILLIMETERS		
Dimension Limits			MIN	NOM	MAX
Number of Terminals	N		88		
Pitch	e		0.50 BSC		
Overall Terminal Spacing	eD		5.00 BSC		
Overall Terminal Spacing	eE		5.00 BSC		
Overall Height	A	–	–	0.60	
Standoff	A1	0.11	–	0.21	
Overall Length	D		6.00 BSC		
Overall Width	E		6.00 BSC		
Terminal Diameter	b	0.22	0.25	0.28	

Notes:

1. Pin 1 visual index feature may vary, but must be located within the hatched area.
2. Dimensioning and tolerancing per ASME Y14.5M
 BSC: Basic Dimension. Theoretically exact value shown without tolerances.
 REF: Reference Dimension, usually without tolerance, for information purposes only.

mXT448UD-CCUBHA1 1.0

88-Ball Ultra Thin Fine Pitch Ball Grid Array (BVB) - 6x6x0.6 mm Body [UFBGA] Atmel Legacy Global Package Code CJM

Note: For the most current package drawings, please see the Microchip Packaging Specification located at <http://www.microchip.com/packaging>

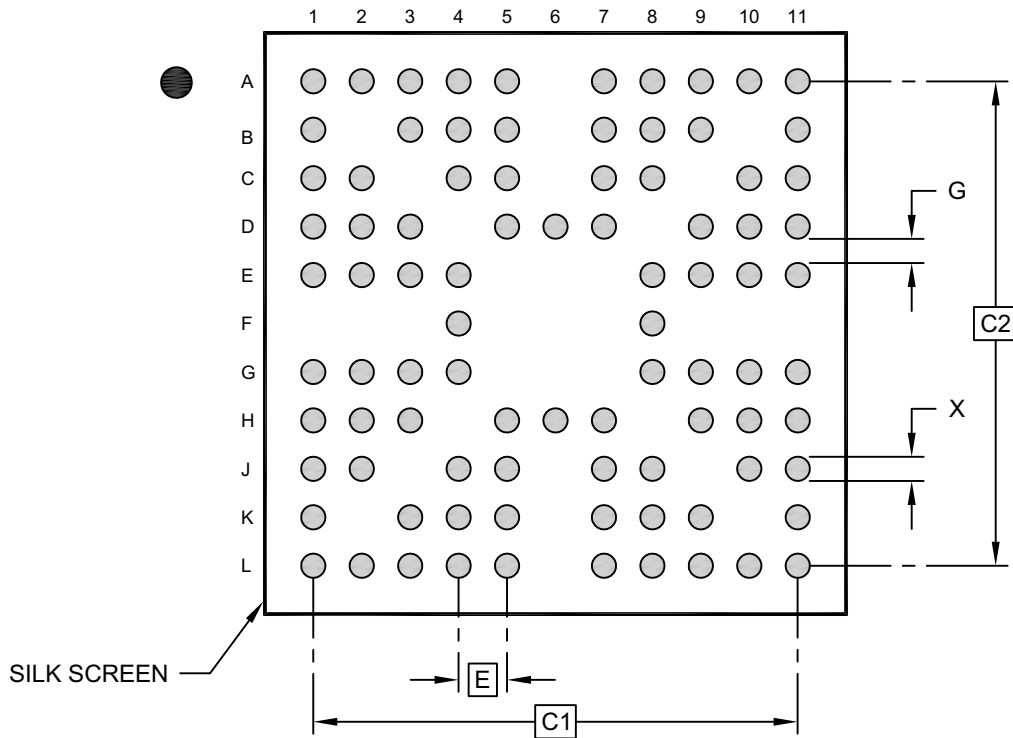

RECOMMENDED LAND PATTERN

Dimension Limits	Units	MILLIMETERS		
		MIN	NOM	MAX
Contact Pitch	E		0.50 BSC	
Overall Contact Pitch	C1		5.00 BSC	
Overall Contact Pitch	C2		5.00 BSC	
Contact Pad Diameter	X			0.28
Contact Pad to Contact Pad	G	0.25		

Notes:

- Dimensioning and tolerancing per ASME Y14.5M
BSC: Basic Dimension. Theoretically exact value shown without tolerances.
- For best soldering results, thermal vias, if used, should be filled or tented to avoid solder loss during reflow process

Microchip Technology Drawing C04-23158 Rev A

APPENDIX A: ASSOCIATED DOCUMENTS

Microchip maXTouch Documents

The following documents are available on the Microchip website, except where indicated.

Touchscreen Design and PCB/FPCB Layout Guidelines

- Application Note: MXTAN0208 – *Design Guide for PCB Layouts for maXTouch Touch Controllers*
- Application Note: QTAN0080 – *Touchscreens Sensor Design Guide*
- Application Note: AN2683 – *Edge Wiring for Self Capacitance maXTouch Touchscreens*

Configuring and Tuning the Device

- Application Note: MXTAN0213 – *Interfacing with maXTouch Touchscreen Controllers*

Tools

- *maXTouch Studio User Guide* (accessible as on-line help from within maXTouch Studio)

External Documents

The following documents are not supplied by Microchip. To obtain any of the following documents, please contact the relevant organization.

Standards

- IEC 60730-1, *Automatic electrical controls – Part 1: General requirement*, Edition 5.1, 2015-12
- UL 60730-1, *Automatic Electrical Controls – Part 1: General Requirements*, Edition 5, 2016-08-03

Communication Interfaces

- UM10204, *I²C bus specification and user manual*, Rev. 6 — 4 April 2014
Available from NXP
- AN991/D, *Using the Serial Peripheral Interface to Communicate Between Multiple Microcomputers*, Rev. 1
January 2002
Available from NXP

APPENDIX B: REVISION HISTORY

Revision A (September 2021)

Initial edition for firmware revision 1.0.AA – Release

INDEX

A

Absolute maximum specifications 52
 Adjacent key suppression technology 23
 AKS. See *Adjacent key suppression*
 Analog I/O 43
 Analog voltage supply 53
 AVdd voltage supply 53

C

Calibration 20
 Capacitive Touch Engine (CTE) 9
 Charge time 20
 CHG_I2C line 18, 28
 mode 0 operation 29
 mode 1 operation 29
 CHG_SPI line 18, 31
 Clock stretching 30
 Communications 24
 primary communications interface 24
 secondary communications interface 24
 Component placement and tracking 43
 Connection Information see *Pinouts* 3
 Customer Change Notification Service 74
 Customer Notification Service 74
 Customer Support 74

D

DC characteristics 53
 Debugging 50
 Hardware Debug Interface 12, 50
 object-based protocol 50
 self test 50
 Decoupling capacitors 11, 40
 Detailed operation 20
 Detection integrator 20
 Device
 overview 9
 Digital filtering 21
 Digital signals 44
 Digital voltage supply 53
 Direct Memory Access 27
 Driven shield lines 11, 16, 42

E

EMC problems 44
 EMC Reduction 21
 ESD information 64

G

Generic key array 14
 Glove detection 22
 GPIO pins 12
 Grip suppression 22
 Ground tracking 40

H

Hardware Debug Interface 12, 50

I

I/O pins 11
 I²C communications 25–30
 CHG_I2C line 28
 clock stretching 30
 primary interface address selection 24

reading from the device 25
 reading messages with DMA 27
 SCL line 30
 SDA line 30
 specification 63
 writing to the device 25
 I²C interface
 SCL line 11, 30
 SDA line 11, 30
 Input/Output characteristics 62
 Internet Address 74

J

Junction temperature 64

L

latency, touch 61
 Lens bending 22

M

Microchip Internet Web Site 74
 MISO line 31
 Moisture sensitivity level (msl) 64
 MOSI line 31
 Multiple function pins 11
 Mutual capacitance measurements 9

N

Noise suppression 21
 display 21
 Number of available nodes 11

O

Object-based protocol (OBP) 45, 50
 Operational modes 20
 Overview of the mXT448UD-CCUBHA1 9

P

PCB cleanliness 40
 PCB design 40
 analog I/O 43
 component placement and tracking 43
 decoupling capacitors 40
 digital signals 44
 EMC problems 44
 ground tracking 40
 PCB cleanliness 40
 power supply 40
 supply rails 40
 voltage pump 40
 voltage regulator 41
 Pinouts 3
 Power supply
 I/O pins 11
 PCB design 40
 Power supply ripple and noise 53
 Power-up procedure 45
 Power-up/reset 17
 hardware reset 18
 power-on reset (POR) 17
 software reset 18
 VddIO enabled after Vdd 19
 Primary communications interface 24
 Pull-up resistors 11

mXT448UD-CCUBHA1 1.0

R

Reading from the Device.....	49
Recommended operating conditions.....	52
Repeatability	62
Report rate	61
Reset timings	62
Retransmission compensation	22

S

Safety tests	50
Schematic	10
decoupling capacitors	11
GPIO pins.....	12
I ² C interface	11
number of available nodes.....	11
pull-up resistors.....	11
voltage pump.....	11
SCK line	31
SCL line.....	11, 30
SDA line	11, 30
Secondary communications interface	24
Self capacitance measurements	9
Self test	50
Sensor acquisition.....	20
Sensor layout	14–16
electrodes.....	14
sensors.....	14
touch panel.....	14
Shieldless support.....	21
Soldering profile	64
Specifications	52–64
absolute maximum specifications	52
analog voltage supply	53
DC characteristics	53
digital voltage supply.....	53
ESD information.....	64
I ² C specification	63
input/output characteristics	62
junction temperature	64
moisture sensitivity level (msl)	64
power supply ripple and noise.....	53
recommended operating conditions	52
repeatability.....	62
reset timings	62
soldering profile.....	64
SPI bus specification.....	63
test configuration.....	54
thermal data	63
timing specifications	61
touch accuracy	62
touchscreen sensor characteristics.....	62
XVdd voltage supply	53
SPI communications	31–39
SPI protocol opcodes.....	32
CHG_SPI line.....	31
communications protocol	31
failed protocol.....	39
general operations	38
MISO line	31
MOSI line	31

operation.....	31
read operation and responses.....	35
SCK line.....	31
specification	63
SPI mode 3.....	31
SPI transaction header	32
SPI_INVALID_CRC	38
SPI_INVALID_REQ	38
SPI_READ_FAIL	37
SPI_READ_OK.....	36
SPI_READ_REQ	35
SPI_WRITE_FAIL.....	34
SPI_WRITE_OK.....	34
SPI_WRITE_REQ	33
SS line	31
write operation and responses	32
SPI_READ_OK.....	36
SS line	31
Start-up procedure.....	45
Stylus support.....	22
Supply rails	40
SYNC pin	12

T

Test configuration specification	54
Thermal data.....	63
Timing specifications	61
report rate	61
touch latency	61
Touch accuracy	62
Touch detection	9, 20
Touch latency	61
Touchscreen sensor characteristics	62
Touchscreen Size size.....	16
Tuning.....	50

U

UL/IEC 60730 Class B compliance.....	21
debugging	50
power up.....	45
reading from the device	49
safety tests	50
writing to the device	48
Unintentional touch suppression.....	23

V

Vdd voltage supply	53
VddCore supply	11
VddIO voltage supply.....	53
Voltage pump.....	11, 40
Voltage regulator	41
multiple supply operation.....	42
single supply operation.....	42

W

Writing to the Device.....	48
WWW Address	74

X

XVdd voltage supply	53
---------------------------	----

PRODUCT IDENTIFICATION SYSTEM

The table below gives details on the product identification system for maXTouch devices. See [“Orderable Part Numbers”](#) below for example part numbers for the mXT448UD-CCUBHA1.

To order or obtain information, for example on pricing or delivery, refer to the factory or the listed sales office.

PART NO.	-XXX	[X]	[X]	[XXX]
Device	Package	Temperature Range	Tape and Reel Option	Pattern
Device:	Base device name			
Package:	CCU	=	UFBGA (Ultra Thin Fine-pitch Ball Grid Array)	
	C2	=	UFBGA (Ultra Thin Fine-pitch Ball Grid Array)	
	NH	=	UFBGA (Ultra Thin Fine-pitch Ball Grid Array)	
	C4	=	X1FBGA (Extra Thin Fine-pitch Ball Grid Array)	
	MA	=	XQFN (Super Thin Quad Flat No Lead Sawn)	
	MA5	=	XQFN (Super Thin Quad Flat No Lead Sawn)	
Temperature Range:	U	=	-40°C to +85°C (Grade 3)	
	T	=	-40°C to +85°C (Grade 3)	
	B	=	-40°C to +105°C (Grade 2)	
Tape and Reel Option:	<i>Blank</i>	=	Standard Packaging (Tube or Tray)	
	R	=	Tape and Reel ⁽¹⁾	
Pattern:	Extension, QTP, SQTP, Code or Special Requirements (Blank Otherwise)			

Note 1: Tape and Reel identifier only appears in the catalog part number description. This identifier is used for ordering purposes and is not printed on the device package. See [“Orderable Part Numbers”](#) below or check with your Microchip Sales Office for package availability with the Tape and Reel option.

Orderable Part Numbers

Orderable Part Number	Firmware Revision	Description
ATMXT448UD-CCUBHA1 (Supplied in trays)	1.0.AA	88-ball UFBGA 6 x 6 x 0.6 mm, RoHS compliant
ATMXT448UD-CCUBRHA1 (Supplied in tape and reel)		

THE MICROCHIP WEB SITE

Microchip provides online support via our WWW site at www.microchip.com. This web site is used as a means to make files and information easily available to customers. Accessible by using your favorite Internet browser, the web site contains the following information:

- **Product Support** – Datasheets and errata, application notes and sample programs, design resources, user's guides and hardware support documents, latest software releases and archived software
- **General Technical Support** – Frequently Asked Questions (FAQ), technical support requests, online discussion groups, Microchip consultant program member listing
- **Business of Microchip** – Product selector and ordering guides, latest Microchip press releases, listing of seminars and events, listings of Microchip sales offices, distributors and factory representatives

THE MAXTOUCH WEB SITE

Information on Microchip's maXTouch product line can be accessed via the microchip web site at www.microchip.com, This information is also available for direct access via a short-cut at www.maxtouch.com. The maXTouch web pages contain the following information:

- **Product Information** – Product specifications, brochures, datasheets, protocol guides
- **Tools and Software** – Evaluation kits, maXTouch Studio, software libraries for individual maXTouch touch controllers
- **Training and Support** – Generic application notes and training material for the maXTouch product range

CUSTOMER CHANGE NOTIFICATION SERVICE

Microchip's customer notification service helps keep customers current on Microchip products. Subscribers will receive e-mail notification whenever there are changes, updates, revisions or errata related to a specified product family or development tool of interest.

To register, access the Microchip web site at www.microchip.com. Under "Support", click on "Customer Change Notification" and follow the registration instructions.

CUSTOMER SUPPORT

Users of Microchip products can receive assistance through several channels:

- Distributor or Representative
- Local Sales Office
- Field Application Engineer (FAE)
- Technical Support

Customers should contact their distributor, representative or Field Application Engineer (FAE) for support. Local sales offices are also available to help customers. A listing of sales offices and locations is included in the back of this document.

Technical support is available through the web site at: <http://microchip.com/support>

Note the following details of the code protection feature on Microchip products:

- Microchip products meet the specifications contained in their particular Microchip Data Sheet.
 - Microchip believes that its family of products is secure when used in the intended manner, within operating specifications, and under normal conditions.
 - Microchip values and aggressively protects its intellectual property rights. Attempts to breach the code protection features of Microchip products is strictly prohibited and may violate the Digital Millennium Copyright Act.
 - Neither Microchip nor any other semiconductor manufacturer can guarantee the security of its code. Code protection does not mean that we are guaranteeing the product is “unbreakable”. Code protection is constantly evolving. Microchip is committed to continuously improving the code protection features of our products.
-

This publication and the information herein may be used only with Microchip products, including to design, test, and integrate Microchip products with your application. Use of this information in any other manner violates these terms. Information regarding device applications is provided only for your convenience and may be superseded by updates. It is your responsibility to ensure that your application meets with your specifications. Contact your local Microchip sales office for additional support or, obtain additional support at <https://www.microchip.com/en-us/support/design-help/client-supportservices>.

THIS INFORMATION IS PROVIDED BY MICROCHIP "AS IS". MICROCHIP MAKES NO REPRESENTATIONS OR WARRANTIES OF ANY KIND WHETHER EXPRESS OR IMPLIED, WRITTEN OR ORAL, STATUTORY OR OTHERWISE, RELATED TO THE INFORMATION INCLUDING BUT NOT LIMITED TO ANY IMPLIED WARRANTIES OF NON-INFRINGEMENT, MERCHANTABILITY, AND FITNESS FOR A PARTICULAR PURPOSE, OR WARRANTIES RELATED TO ITS CONDITION, QUALITY, OR PERFORMANCE.

IN NO EVENT WILL MICROCHIP BE LIABLE FOR ANY INDIRECT, SPECIAL, PUNITIVE, INCIDENTAL, OR CONSEQUENTIAL LOSS, DAMAGE, COST, OR EXPENSE OF ANY KIND WHATSOEVER RELATED TO THE INFORMATION OR ITS USE, HOWEVER CAUSED, EVEN IF MICROCHIP HAS BEEN ADVISED OF THE POSSIBILITY OR THE DAMAGES ARE FORESEEABLE. TO THE FULLEST EXTENT ALLOWED BY LAW, MICROCHIP'S TOTAL LIABILITY ON ALL CLAIMS IN ANY WAY RELATED TO THE INFORMATION OR ITS USE WILL NOT EXCEED THE AMOUNT OF FEES, IF ANY, THAT YOU HAVE PAID DIRECTLY TO MICROCHIP FOR THE INFORMATION. Use of Microchip devices in life support and/or safety applications is entirely at the buyer's risk, and the buyer agrees to defend, indemnify and hold harmless Microchip from any and all damages, claims, suits, or expenses resulting from such use. No licenses are conveyed, implicitly or otherwise, under any Microchip intellectual property rights unless otherwise stated.

Trademarks

The Microchip name and logo, the Microchip logo, Adaptec, AnyRate, AVR, AVR logo, AVR Freaks, BesTime, BitCloud, CryptoMemory, CryptoRF, dsPIC, flexPWR, HELDO, IGLoo, JukeBlox, KeeLoq, Klear, LANCheck, LinkMD, maXStylus, maXTouch, MediaLB, megaAVR, Microsemi, Microsemi logo, MOST, MOST logo, MPLAB, OptoLyzer, PIC, picoPower, PICSTART, PIC32 logo, PolarFire, Prochip Designer, QTouch, SAM-BA, SenGenuity, SpyNIC, SST, SST Logo, SuperFlash, Symmetricom, SyncServer, Tachyon, TimeSource, tinyAVR, UNI/O, Vectron, and XMEGA are registered trademarks of Microchip Technology Incorporated in the U.S.A. and other countries.

AgileSwitch, APT, ClockWorks, The Embedded Control Solutions Company, EtherSynch, Flashtec, Hyper Speed Control, HyperLight Load, IntelliMOS, Libero, motorBench, mTouch, Powermite 3, Precision Edge, ProASIC, ProASIC Plus, ProASIC Plus logo, Quiet-Wire, SmartFusion, SyncWorld, Temux, TimeCesium, TimeHub, TimePictra, TimeProvider, TrueTime, WinPath, and ZL are registered trademarks of Microchip Technology Incorporated in the U.S.A.

Adjacent Key Suppression, AKS, Analog-for-the-Digital Age, Any Capacitor, AnyIn, AnyOut, Augmented Switching, BlueSky, BodyCom, CodeGuard, CryptoAuthentication, CryptoAutomotive, CryptoCompanion, CryptoController, dsPICDEM, dsPICDEM.net, Dynamic Average Matching, DAM, ECAN, Espresso T1S, EtherGREEN, GridTime, IdealBridge, In-Circuit Serial Programming, ICSP, INICnet, Intelligent Paralleling, Inter-Chip Connectivity, JitterBlocker, Knob-on-Display, maxCrypto, maxView, memBrain, Mindi, MiWi, MPASM, MPF, MPLAB Certified logo, MPLIB, MPLINK, MultiTRAK, NetDetach, NVM Express, NVMe, Omniscent Code Generation, PICDEM, PICDEM.net, PICkit, PICtail, PowerSmart, PureSilicon, QMatrix, REAL ICE, Ripple Blocker, RTAX, RTG4, SAM-ICE, Serial Quad I/O, simpleMAP, SimpliPHY, SmartBuffer, SmartHLS, SMART-I.S., storClad, SQL, SuperSwitcher, SuperSwitcher II, Switchtec, SynchroPHY, Total Endurance, TSHARC, USBCheck, VariSense, VectorBlox, VeriPHY, ViewSpan, WiperLock, XpressConnect, and ZENA are trademarks of Microchip Technology Incorporated in the U.S.A. and other countries.

SQTP is a service mark of Microchip Technology Incorporated in the U.S.A.

The Adaptec logo, Frequency on Demand, Silicon Storage Technology, Symmcom, and Trusted Time are registered trademarks of Microchip Technology Inc. in other countries.

GestIC is a registered trademark of Microchip Technology Germany II GmbH & Co. KG, a subsidiary of Microchip Technology Inc., in other countries.

All other trademarks mentioned herein are property of their respective companies.

© 2021, Microchip Technology Incorporated and its subsidiaries.

All Rights Reserved.

ISBN: 978-1-5224-8902-3

For information regarding Microchip's Quality Management Systems, please visit www.microchip.com/quality.

Worldwide Sales and Service

AMERICAS

Corporate Office
 2355 West Chandler Blvd.
 Chandler, AZ 85224-6199
 Tel: 480-792-7200
 Fax: 480-792-7277
 Technical Support:
[http://www.microchip.com/
 support](http://www.microchip.com/support)
 Web Address:
www.microchip.com

Atlanta
 Duluth, GA
 Tel: 678-957-9614
 Fax: 678-957-1455

Austin, TX
 Tel: 512-257-3370

Boston
 Westborough, MA
 Tel: 774-760-0087
 Fax: 774-760-0088

Chicago
 Itasca, IL
 Tel: 630-285-0071
 Fax: 630-285-0075

Dallas
 Addison, TX
 Tel: 972-818-7423
 Fax: 972-818-2924

Detroit
 Novi, MI
 Tel: 248-848-4000

Houston, TX
 Tel: 281-894-5983

Indianapolis
 Noblesville, IN
 Tel: 317-773-8323
 Fax: 317-773-5453
 Tel: 317-536-2380

Los Angeles
 Mission Viejo, CA
 Tel: 949-462-9523
 Fax: 949-462-9608
 Tel: 951-273-7800

Raleigh, NC
 Tel: 919-844-7510

New York, NY
 Tel: 631-435-6000

San Jose, CA
 Tel: 408-735-9110
 Tel: 408-436-4270

Canada - Toronto
 Tel: 905-695-1980
 Fax: 905-695-2078

ASIA/PACIFIC

Australia - Sydney
 Tel: 61-2-9868-6733

China - Beijing
 Tel: 86-10-8569-7000

China - Chengdu
 Tel: 86-28-8665-5511

China - Chongqing
 Tel: 86-23-8980-9588

China - Dongguan
 Tel: 86-769-8702-9880

China - Guangzhou
 Tel: 86-20-8755-8029

China - Hangzhou
 Tel: 86-571-8792-8115

China - Hong Kong SAR
 Tel: 852-2943-5100

China - Nanjing
 Tel: 86-25-8473-2460

China - Qingdao
 Tel: 86-532-8502-7355

China - Shanghai
 Tel: 86-21-3326-8000

China - Shenyang
 Tel: 86-24-2334-2829

China - Shenzhen
 Tel: 86-755-8864-2200

China - Suzhou
 Tel: 86-186-6233-1526

China - Wuhan
 Tel: 86-27-5980-5300

China - Xian
 Tel: 86-29-8833-7252

China - Xiamen
 Tel: 86-592-2388138

China - Zhuhai
 Tel: 86-756-3210040

ASIA/PACIFIC

India - Bangalore
 Tel: 91-80-3090-4444

India - New Delhi
 Tel: 91-11-4160-8631

India - Pune
 Tel: 91-20-4121-0141

Japan - Osaka
 Tel: 81-6-6152-7160

Japan - Tokyo
 Tel: 81-3-6880- 3770

Korea - Daegu
 Tel: 82-53-744-4301

Korea - Seoul
 Tel: 82-2-554-7200

Malaysia - Kuala Lumpur
 Tel: 60-3-7651-7906

Malaysia - Penang
 Tel: 60-4-227-8870

Philippines - Manila
 Tel: 63-2-634-9065

Singapore
 Tel: 65-6334-8870

Taiwan - Hsin Chu
 Tel: 886-3-577-8366

Taiwan - Kaohsiung
 Tel: 886-7-213-7830

Taiwan - Taipei
 Tel: 886-2-2508-8600

Thailand - Bangkok
 Tel: 66-2-694-1351

Vietnam - Ho Chi Minh
 Tel: 84-28-5448-2100

EUROPE

Austria - Wels
 Tel: 43-7242-2244-39
 Fax: 43-7242-2244-393

Denmark - Copenhagen
 Tel: 45-4485-5910
 Fax: 45-4485-2829

Finland - Espoo
 Tel: 358-9-4520-820

France - Paris
 Tel: 33-1-69-53-63-20
 Fax: 33-1-69-30-90-79

Germany - Garching
 Tel: 49-8931-9700

Germany - Haan
 Tel: 49-2129-3766400

Germany - Heilbronn
 Tel: 49-7131-72400

Germany - Karlsruhe
 Tel: 49-721-625370

Germany - Munich
 Tel: 49-89-627-144-0
 Fax: 49-89-627-144-44

Germany - Rosenheim
 Tel: 49-8031-354-560

Israel - Ra'anana
 Tel: 972-9-744-7705

Italy - Milan
 Tel: 39-0331-742611
 Fax: 39-0331-466781

Italy - Padova
 Tel: 39-049-7625286

Netherlands - Drunen
 Tel: 31-416-690399
 Fax: 31-416-690340

Norway - Trondheim
 Tel: 47-7288-4388

Poland - Warsaw
 Tel: 48-22-3325737

Romania - Bucharest
 Tel: 40-21-407-87-50

Spain - Madrid
 Tel: 34-91-708-08-90
 Fax: 34-91-708-08-91

Sweden - Gothenberg
 Tel: 46-31-704-60-40

Sweden - Stockholm
 Tel: 46-8-5090-4654

UK - Wokingham
 Tel: 44-118-921-5800
 Fax: 44-118-921-5820