

DATA SHEET

TDA1524A

Stereo-tone/volume control circuit

Product specification
File under Integrated Circuits, IC01

September 1987

Stereo-tone/volume control circuit

TDA1524A

GENERAL DESCRIPTION

The device is designed as an active stereo-tone/volume control for car radios, TV receivers and mains-fed equipment. It includes functions for bass and treble control, volume control with built-in contour (can be switched off) and balance. All these functions can be controlled by d.c. voltages or by single linear potentiometers.

Features

- Few external components necessary
- Low noise due to internal gain
- Bass emphasis can be increased by a double-pole low-pass filter
- Wide power supply voltage range.

QUICK REFERENCE DATA

Supply voltage (pin 3)	$V_P = V_{3-18}$	typ.	12	V
Supply current (pin 3)	$I_P = I_3$	typ.	35	mA
Maximum input signal with d.c. feedback (r.m.s. value)	$V_{i(rms)}$	typ.	2,5	V
Maximum output signal with d.c. feedback (r.m.s. value)	$V_{o(rms)}$	typ.	3	V
Volume control range	G_V		-80 to + 21,5	dB
Bass control range at 40 Hz	ΔG_V		-19 to + 17	dB
Treble control range at 16 kHz	ΔG_V	typ.	± 15	dB
Total harmonic distortion	THD	typ.	0,3	%
Output noise voltage (unweighted; r.m.s. value) at $f = 20$ Hz to 20 kHz; $V_P = 12$ V; for max. voltage gain	$V_{no(rms)}$	typ.	310	μV
for voltage gain $G_V = -40$ dB	$V_{no(rms)}$	typ.	100	μV
Channel separation at $G_V = -20$ to + 21,5 dB	α_{cs}	typ.	60	dB
Tracking between channels at $G_V = -20$ to + 26 dB	ΔG_V	max.	2,5	dB
Ripple rejection at 100 Hz	RR	typ.	50	dB
Supply voltage range (pin 3)	$V_P = V_{3-18}$		7,5 to 16,5	V
Operating ambient temperature range	T_{amb}		-30 to + 80	$^{\circ}C$

PACKAGE OUTLINE

18-lead DIL; plastic (SOT102); SOT102-1; 1996 July 22.

Stereo-tone/volume control circuit

TDA1524A

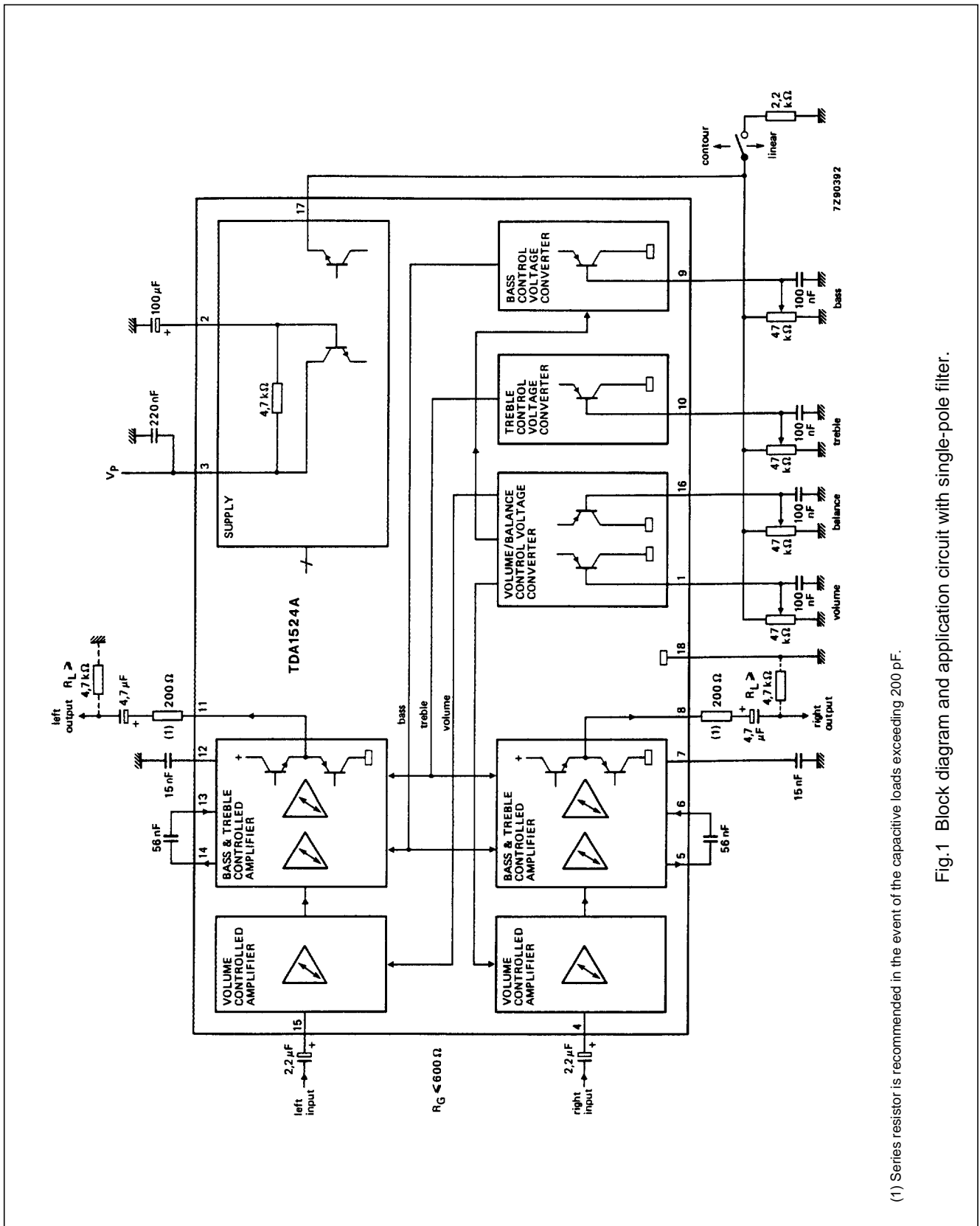

(1) Series resistor is recommended in the event of the capacitive loads exceeding 200 pF.

Fig. 1 Block diagram and application circuit with single-pole filter.

Stereo-tone/volume control circuit

TDA1524A

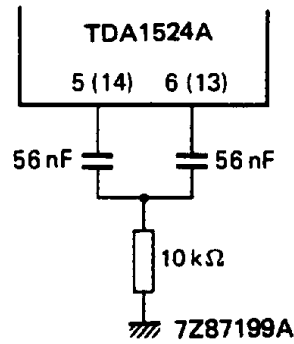

Fig.2 Double-pole low-pass filter for improved bass-boost.

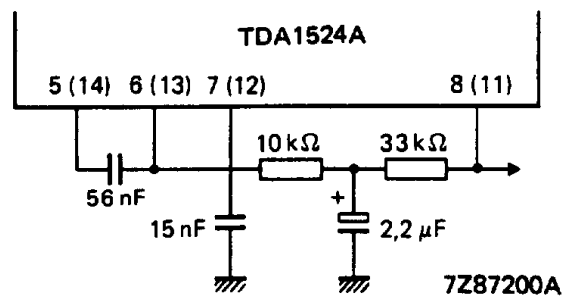

Fig.3 D.C. feedback with filter network for improved signal handling.

Stereo-tone/volume control circuit

TDA1524A

RATINGS

Limiting values in accordance with the Absolute Maximum System (IEC 134)

Supply voltage (pin 3)	$V_P = V_{3-18}$	max.	20 V
Total power dissipation	P_{tot}	max.	1200 mW
Storage temperature range	T_{stg}		-55 to + 150 °C
Operating ambient temperature range	T_{amb}		-30 to +80 °C

D.C. CHARACTERISTICS

 $V_P = V_{3-18} = 12$ V; $T_{amb} = 25$ °C; measured in Fig.1; $R_G \leq 600$ Ω ; $R_L \geq 4,7$ k Ω ; $C_L \leq 200$ pF; unless otherwise specified

PARAMETER	SYMBOL	MIN.	TYP.	MAX.	UNIT
Supply (pin 3)					
Supply voltage	$V_P = V_{3-18}$	7,5	–	16,5	V
Supply current					
at $V_P = 8,5$ V	$I_P = I_3$	19	27	35	mA
at $V_P = 12$ V	$I_P = I_3$	25	35	45	mA
at $V_P = 15$ V	$I_P = I_3$	30	43	56	mA
D.C. input levels (pins 4 and 15)					
at $V_P = 8,5$ V	$V_{4,15-18}$	3,8	4,25	4,7	V
at $V_P = 12$ V	$V_{4,15-18}$	5,3	5,9	6,6	V
at $V_P = 15$ V	$V_{4,15-18}$	6,5	7,3	8,2	V
D.C. output levels (pins 8 and 11) under all control voltage conditions with d.c. feedback (Fig.3)					
at $V_P = 8,5$ V	$V_{8,11-18}$	3,3	4,25	5,2	V
at $V_P = 12$ V	$V_{8,11-18}$	4,6	6,0	7,4	V
at $V_P = 15$ V	$V_{8,11-18}$	5,7	7,5	9,3	V
Pin 17					
Internal potentiometer supply voltage at $V_P = 8,5$ V	V_{17-18}	3,5	3,75	4,0	V
Contour on/off switch (control by I_{17})					
contour (switch open)	$-I_{17}$	–	–	0,5	mA
linear (switch closed)	$-I_{17}$	1,5	–	10	mA
Application without internal potentiometer supply voltage at $V_P \geq 10,8$ V (contour cannot be switched off)					
Voltage range forced to pin 17	V_{17-18}	4,5	–	$V_P/2 - V_{BE}$	V

Stereo-tone/volume control circuit

TDA1524A

PARAMETER	SYMBOL	MIN.	TYP.	MAX.	UNIT
D.C. control voltage range for volume, bass, treble and balance (pins 1, 9, 10 and 16 respectively) at $V_{17-18} = 5\text{ V}$	$V_{1,9,10,16}$	1,0	—	4,25	V
using internal supply	$V_{1,9,10,16}$	0,25	—	3,8	V
Input current of control inputs (pins 1,9,10 and 16)	$-I_{1,9,10,16}$	—	—	5	μA

A.C. CHARACTERISTICS

$V_P = V_{3-18} = 8,5\text{ V}$; $T_{\text{amb}} = 25\text{ }^\circ\text{C}$; measured in Fig.1; contour switch closed (linear position); volume, balance, bass, and treble controls in mid-position; $R_G \leq 600\ \Omega$; $R_L \geq 4,7\text{ k}\Omega$; $C_L \leq 200\text{ pF}$; $f = 1\text{ kHz}$; unless otherwise specified

PARAMETER	SYMBOL	MIN.	TYP.	MAX.	UNIT
Control range					
Max. gain of volume (Fig.5)	$G_{V\text{ max}}$	20,5	21,5	23	dB
Volume control range; $G_{V\text{ max}}/G_{V\text{ min}}$	ΔG_V	90	100	—	dB
Balance control range; $G_V = 0\text{ dB}$ (Fig.6)	ΔG_V	—	-40	—	dB
Bass control range at 40 Hz (Fig.7)	ΔG_V	—	-19 to + 17 ± 3	—	dB
Treble control range at 16 kHz (Fig.8)	ΔG_V	—	$\pm 15 \pm 3$	—	dB
Control characteristics		see Fig.9 and 10			
Signal inputs, outputs					
Input resistance; pins 4 and 15 (note 1) at gain of volume control: $G_V = 20\text{ dB}$	$R_{i4,15}$	10	—	—	$\text{k}\Omega$
$G_V = -40\text{ dB}$	$R_{i4,15}$	—	160	—	$\text{k}\Omega$
Output resistance (pins 8 and 11)	$R_{o8,11}$	—	—	300	Ω
Signal processing					
Power supply ripple rejection at $V_{P(\text{rms})} \leq 200\text{ mV}$; $f = 100\text{ Hz}$; $G_V = 0\text{ dB}$	RR	35	50	—	dB
Channel separation (250 Hz to 10 kHz) at $G_V = -20\text{ to } + 21,5\text{ dB}$	α_{cs}	46	60	—	dB
Spread of volume control with constant control voltage $V_{1-18} = 0,5 V_{17-18}$	ΔG_V	—	—	± 3	dB
Gain tolerance between left and right channel $V_{16-18} = V_{1-18} = 0,5 V_{17-18}$	$\Delta G_{V,L-R}$	—	—	1,5	dB
Tracking between channels for $G_V = 21,5\text{ to } -26\text{ dB}$ $f = 250\text{ Hz to } 6,3\text{ kHz}$; balance adjusted at $G_V = 10\text{ dB}$	ΔG_V	—	—	2,5	dB

Stereo-tone/volume control circuit

TDA1524A

PARAMETER	SYMBOL	MIN.	TYP.	MAX.	UNIT
Signal handling with d.c. feedback (Fig.3)					
Input signal handling					
at $V_P = 8,5$ V; THD = 0,5%; f = 1 kHz (r.m.s. value)	$V_{i(rms)}$	1,4	–	–	V
at $V_P = 8,5$ V; THD = 0,7%; f = 1 kHz (r.m.s. value)	$V_{i(rms)}$	1,8	2,4	–	V
at $V_P = 12$ V; THD = 0,5%; f = 40 Hz to 16 kHz (r.m.s. value)	$V_{i(rms)}$	1,4	–	–	V
at $V_P = 12$ V; THD = 0,7%; f = 40 Hz to 16 kHz (r.m.s. value)	$V_{i(rms)}$	2,0	3,2	–	V
at $V_P = 15$ V; THD = 0,5%; f = 40 Hz to 16 kHz (r.m.s. value)	$V_{i(rms)}$	1,4	–	–	V
at $V_P = 15$ V; THD = 0,7%; f = 40 Hz to 16 kHz (r.m.s. value)	$V_{i(rms)}$	2,0	3,2	–	V
Output signal handling (note 2 and note 3)					
at $V_P = 8,5$ V; THD = 0,5%; f = 1 kHz (r.m.s. value)	$V_{o(rms)}$	1,8	2,0	–	V
at $V_P = 8,5$ V; THD = 10%; f = 1 kHz (r.m.s. value)	$V_{o(rms)}$	–	2,2	–	V
at $V_P = 12$ V; THD = 0,5%; f = 40 Hz to 16 kHz (r.m.s. value)	$V_{o(rms)}$	2,5	3,0	–	V
at $V_P = 15$ V; THD = 0,5%; f = 40 Hz to 16 kHz (r.m.s. value)	$V_{o(rms)}$	–	3,5	–	V
Noise performance ($V_P = 8,5$ V)					
Output noise voltage (unweighted; Fig.15)					
at f = 20 Hz to 20 kHz (r.m.s. value) for maximum voltage gain (note 4)	$V_{no(rms)}$	–	260	–	μ V
for $G_V = -3$ dB (note 4)	$V_{no(rms)}$	–	70	140	μ V
Output noise voltage; weighted as DIN 45405 of 1981, CCIR recommendation 468-2 (peak value)					
for maximum voltage gain (note 4)	$V_{no(m)}$	–	890	–	μ V
for maximum emphasis of bass and treble (contour off; $G_V = -40$ dB)	$V_{no(m)}$	–	360	–	μ V

Stereo-tone/volume control circuit

TDA1524A

PARAMETER	SYMBOL	MIN.	TYP.	MAX.	UNIT
Noise performance ($V_P = 12\text{ V}$)					
Output noise voltage (unweighted; Fig.15) at $f = 20\text{ Hz}$ to 20 kHz (r.m.s. value; note 5) for maximum voltage gain (note 4)	$V_{no(rms)}$	–	310	–	μV
for $G_V = -16\text{ dB}$ (note 4)	$V_{no(rms)}$	–	100	200	μV
Output noise voltage; weighted as DIN 45405 of 1981, CCIR recommendation 468-2 (peak value) for maximum voltage gain (note 4)	$V_{no(m)}$	–	940	–	μV
for maximum emphasis of bass and treble (contour off; $G_V = -40\text{ dB}$)	$V_{no(m)}$	–	400	–	μV
Noise performance ($V_P = 15\text{ V}$)					
Output noise voltage (unweighted; Fig.15) at $f = 20\text{ Hz}$ to 20 kHz (r.m.s. value; note 5) for maximum voltage gain (note 4)	$V_{no(rms)}$	–	350	–	μV
for $G_V = 16\text{ dB}$ (note 4)	$V_{no(rms)}$	–	110	220	μV
Output noise voltage; weighted as DIN 45405 of 1981, CCIR recommendation 468-2 (peak value) for maximum voltage gain (note 4)	$V_{no(m)}$	–	980	–	μV
for maximum emphasis of bass and treble (contour off; $G_V = -40\text{ dB}$)	$V_{no(m)}$	–	420	–	μV

Notes to characteristics

- Equation for input resistance (see also Fig.4)

$$R_i = \frac{160\text{ k}\Omega}{1 + G_V}; G_{Vmax} = 12$$

- Frequencies below 200 Hz and above 5 kHz have reduced voltage swing, the reduction at 40 Hz and at 16 kHz is 30%.
- In the event of bass boosting the output signal handling is reduced. The reduction is 1 dB for maximum bass boost.
- Linear frequency response.
- For peak values add 4,5 dB to r.m.s. values.

Stereo-tone/volume control circuit

TDA1524A

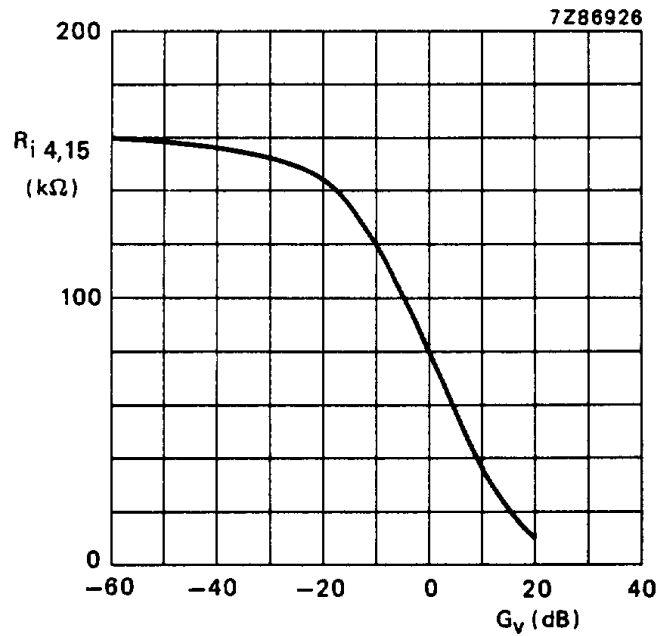

Fig.4 Input resistance (R_i) as a function of gain of volume control (G_v). Measured in Fig.1.

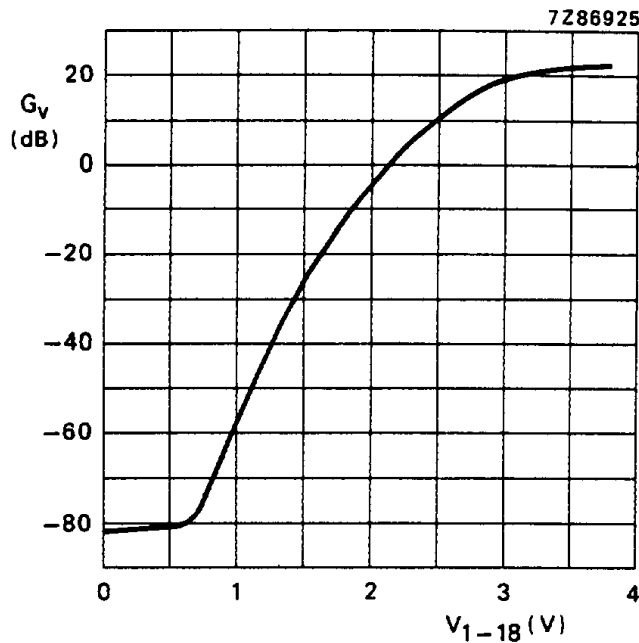

Fig.5 Volume control curve; voltage gain (G_v) as a function of control voltage (V₁₋₁₈). Measured in Fig.1 (internal potentiometer supply from pin 17 used); V_P = 8,5 V; f = 1 kHz.

Stereo-tone/volume control circuit

TDA1524A

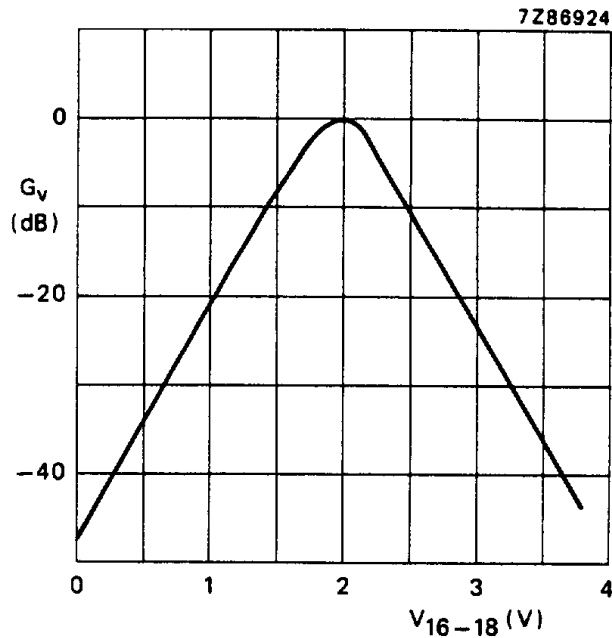

Fig.6 Balance control curve; voltage gain (G_v) as a function of control voltage (V_{16-18}). Measured in Fig.1 (internal potentiometer supply from pin 17 used); $V_P = 8,5$ V.

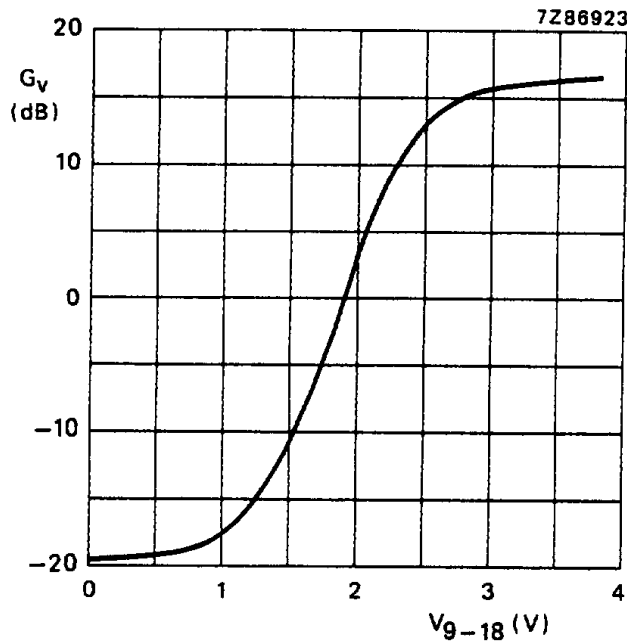
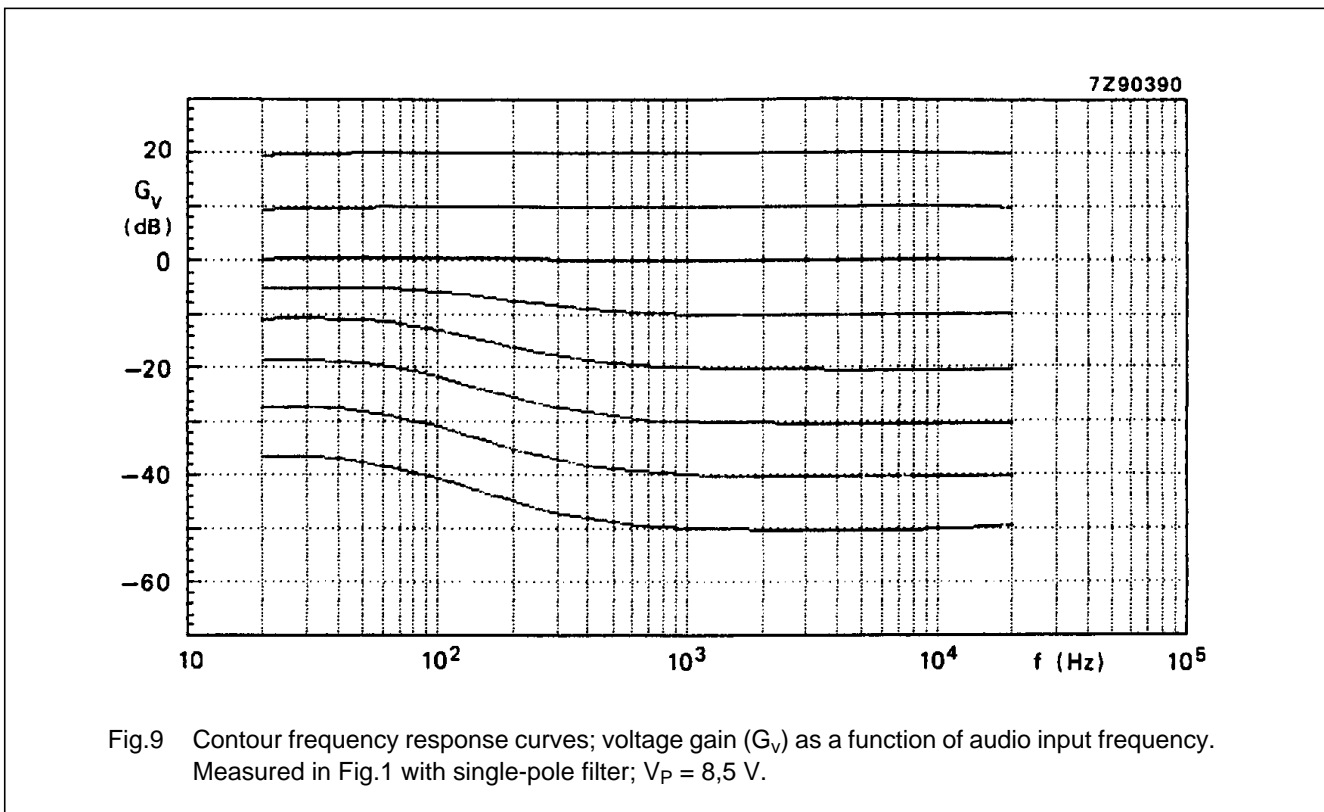
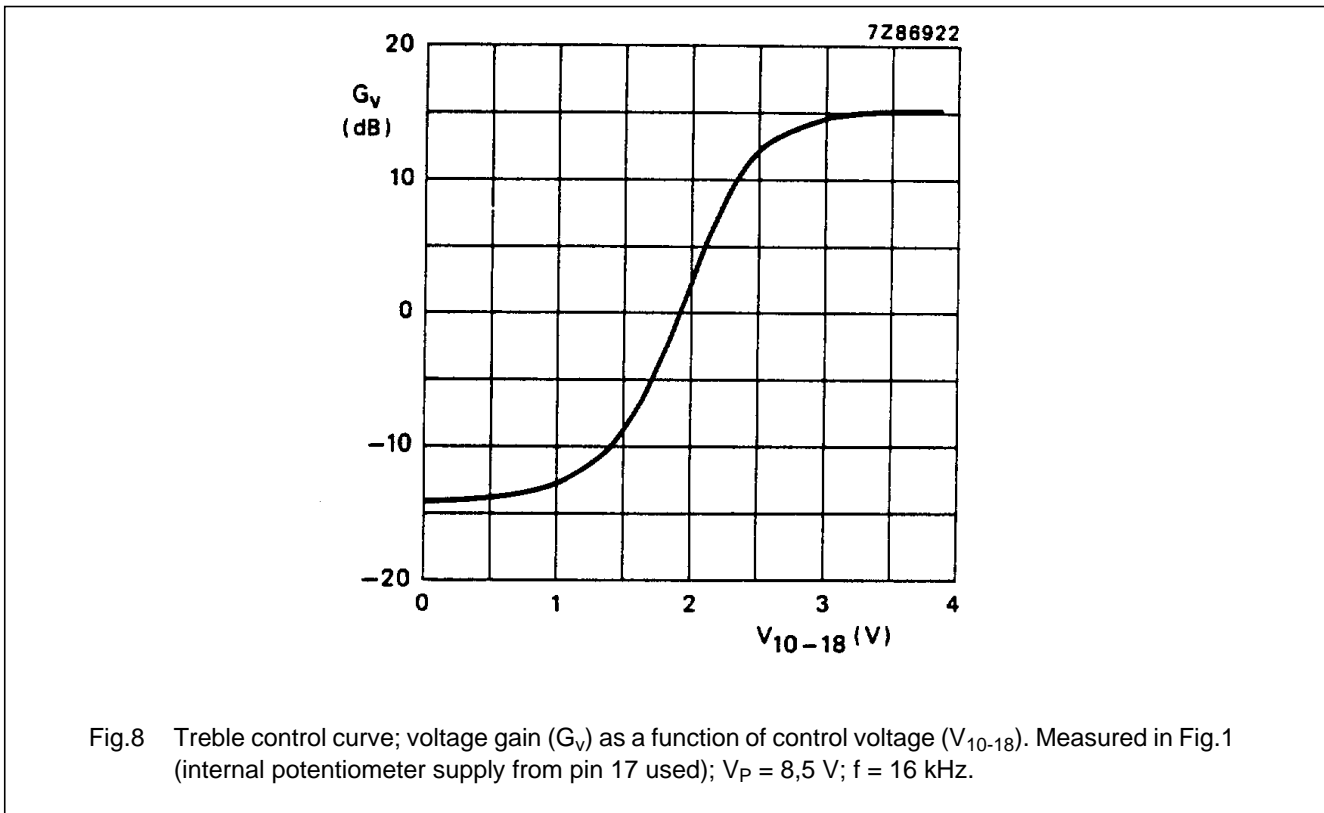

Fig.7 Bass control curve; voltage gain (G_v) as a function of control voltage (V_{9-18}). Measured in Fig.1 with single-pole filter (internal potentiometer supply from pin 17 used); $V_P = 8,5$ V; $f = 40$ Hz.

Stereo-tone/volume control circuit

TDA1524A



Stereo-tone/volume control circuit

TDA1524A

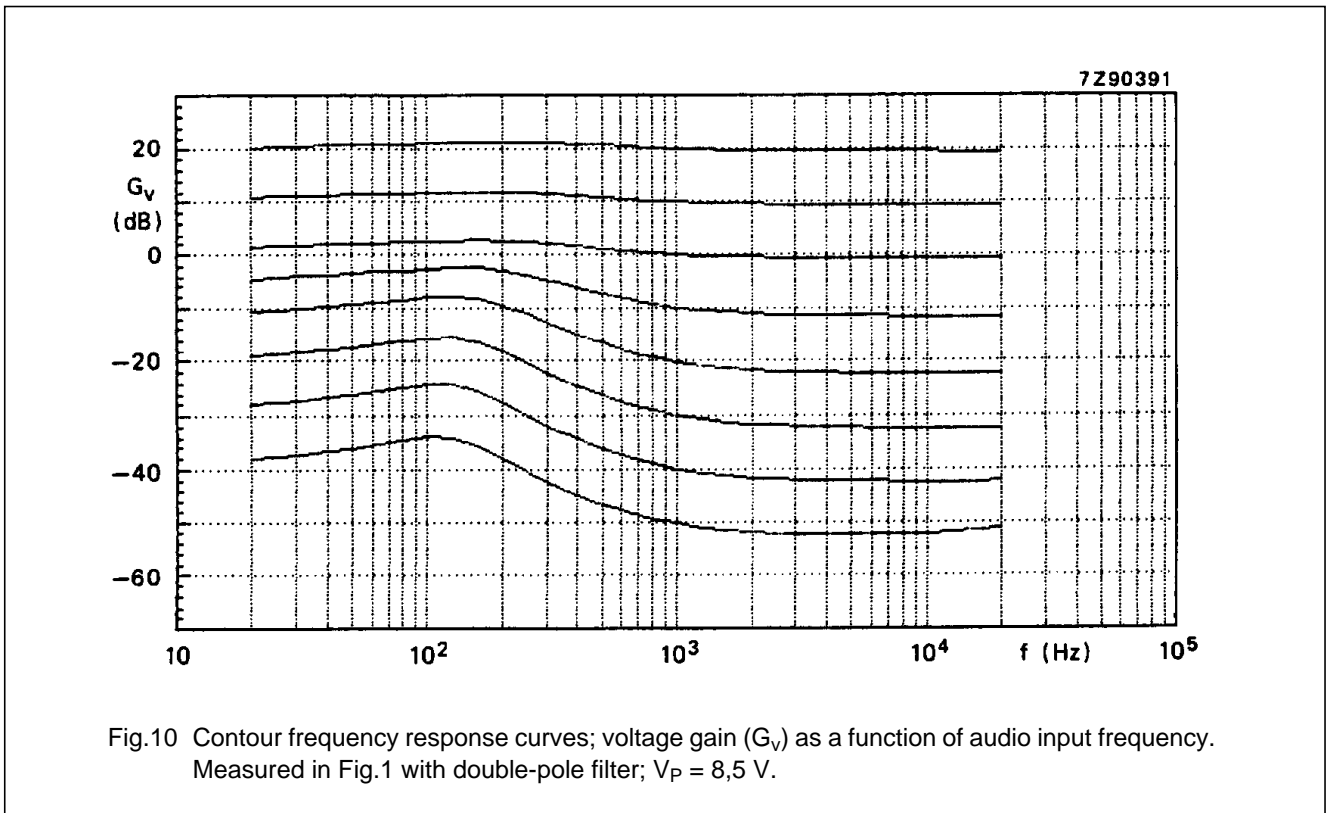

Fig.10 Contour frequency response curves; voltage gain (G_v) as a function of audio input frequency. Measured in Fig.1 with double-pole filter; $V_p = 8,5$ V.

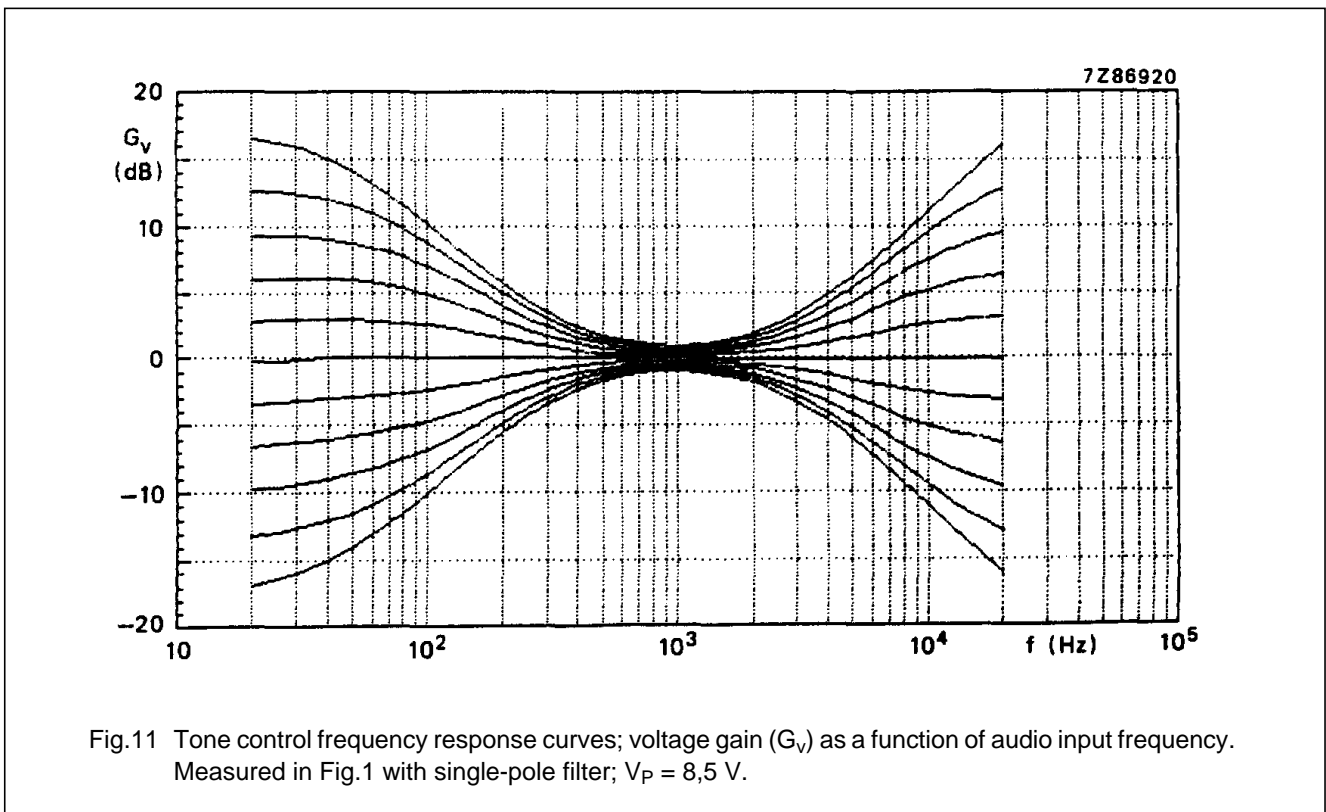
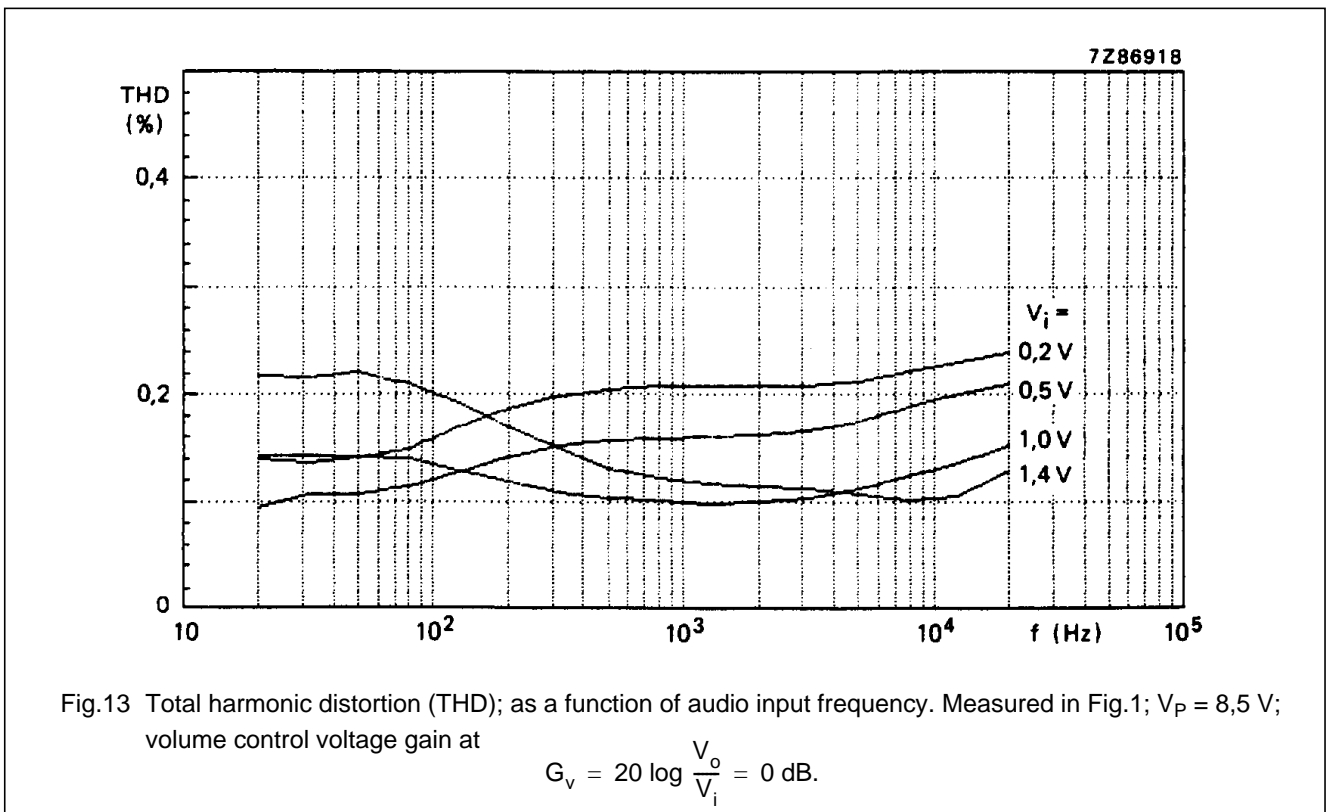
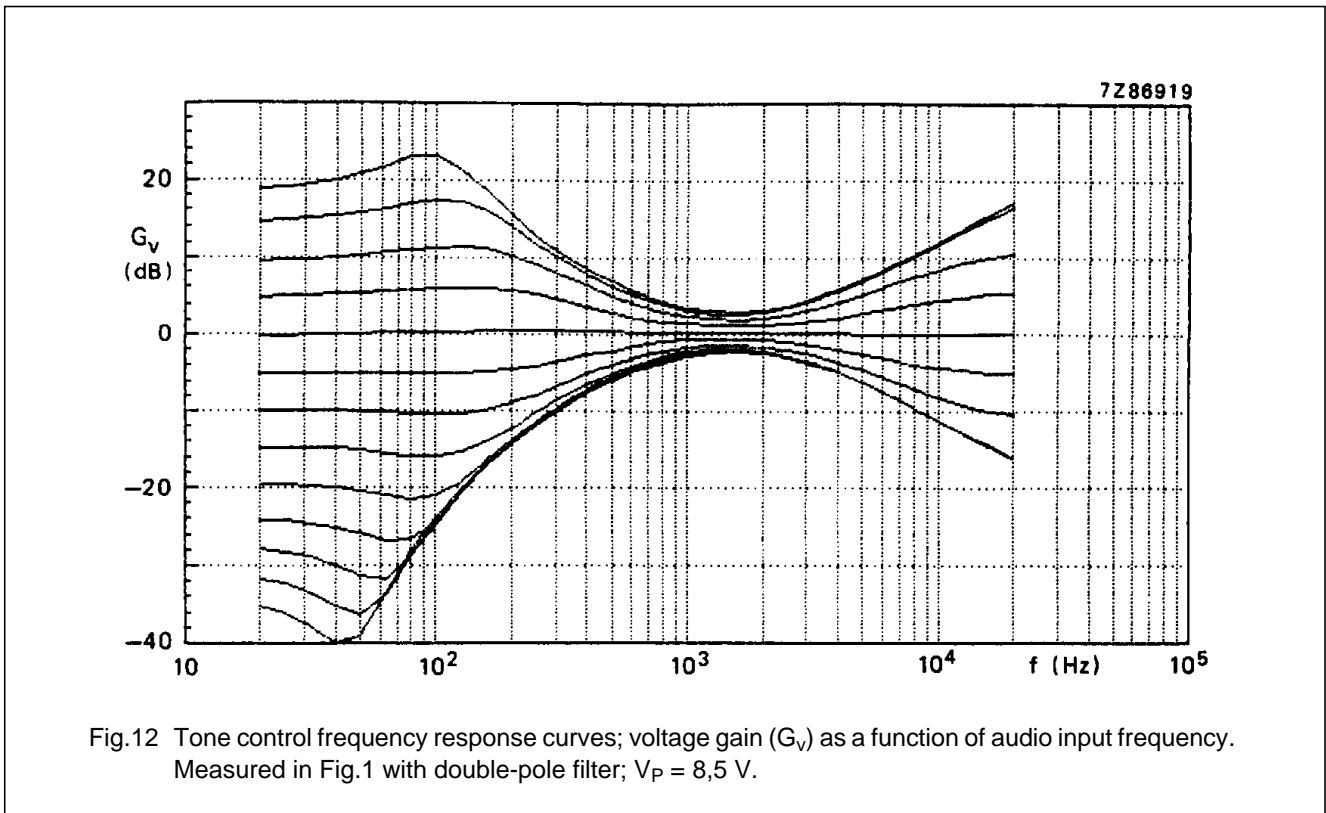

Fig.11 Tone control frequency response curves; voltage gain (G_v) as a function of audio input frequency. Measured in Fig.1 with single-pole filter; $V_p = 8,5$ V.

Stereo-tone/volume control circuit

TDA1524A



Stereo-tone/volume control circuit

TDA1524A

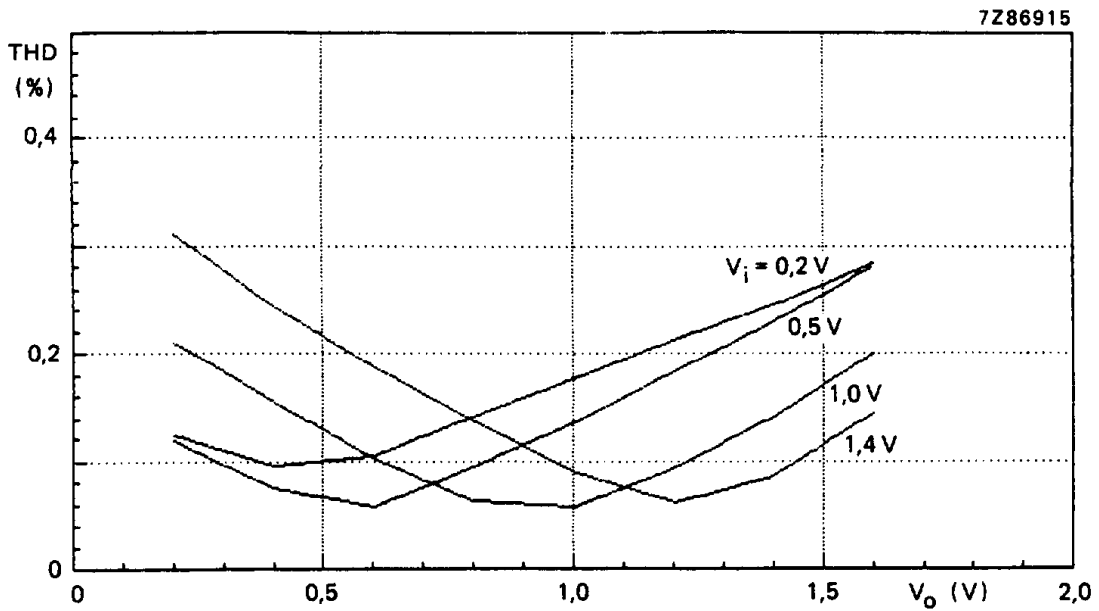
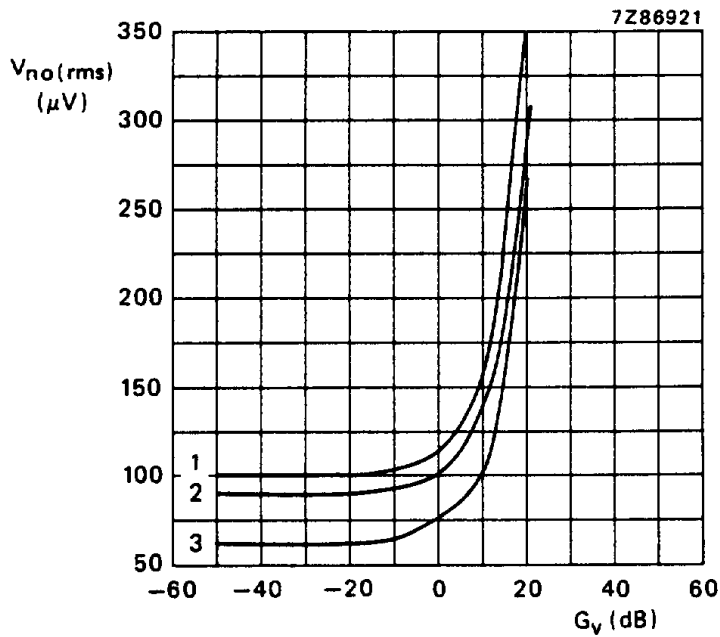

Fig.14 Total harmonic distortion (THD); as a function of output voltage (V_o). Measured in Fig.1; $V_P = 8,5$ V; $f_i = 1$ kHz.



- (1) $V_P = 15$ V.
- (2) $V_P = 12$ V.
- (3) $V_P = 8,5$ V.

Fig.15 Noise output voltage ($V_{no(rms)}$; unweighted); as a function of voltage gain (G_v). Measured in Fig.1; $f = 20$ Hz to 20 kHz.

Stereo-tone/volume control circuit

TDA1524A

PACKAGE OUTLINE

DIP18: plastic dual in-line package; 18 leads (300 mil)

SOT102-1

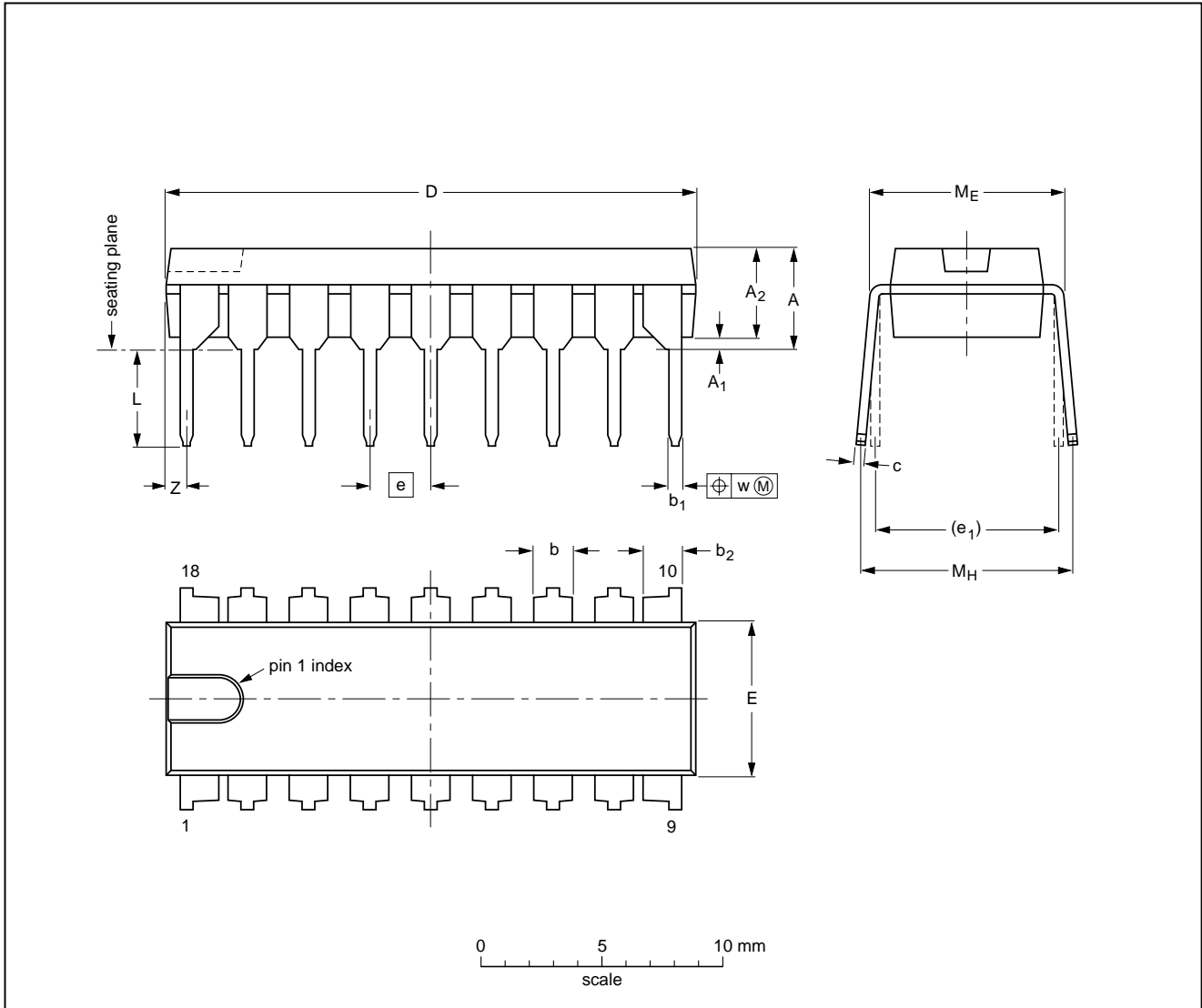

DIMENSIONS (inch dimensions are derived from the original mm dimensions)

UNIT	A max.	A ₁ min.	A ₂ max.	b	b ₁	b ₂	c	D ⁽¹⁾	E ⁽¹⁾	e	e ₁	L	M _E	M _H	w	Z ⁽¹⁾ max.
mm	4.7	0.51	3.7	1.40 1.14	0.53 0.38	1.40 1.14	0.32 0.23	21.8 21.4	6.48 6.20	2.54	7.62	3.9 3.4	8.25 7.80	9.5 8.3	0.254	0.85
inches	0.19	0.020	0.15	0.055 0.044	0.021 0.015	0.055 0.044	0.013 0.009	0.86 0.84	0.26 0.24	0.10	0.30	0.15 0.13	0.32 0.31	0.37 0.33	0.01	0.033

Note

1. Plastic or metal protrusions of 0.25 mm maximum per side are not included.

OUTLINE VERSION	REFERENCES				EUROPEAN PROJECTION	ISSUE DATE
	IEC	JEDEC	EIAJ			
SOT102-1						93-10-14 95-01-23

Stereo-tone/volume control circuit

TDA1524A

SOLDERING**Introduction**

There is no soldering method that is ideal for all IC packages. Wave soldering is often preferred when through-hole and surface mounted components are mixed on one printed-circuit board. However, wave soldering is not always suitable for surface mounted ICs, or for printed-circuits with high population densities. In these situations reflow soldering is often used.

This text gives a very brief insight to a complex technology. A more in-depth account of soldering ICs can be found in our "IC Package Databook" (order code 9398 652 90011).

Soldering by dipping or by wave

The maximum permissible temperature of the solder is 260 °C; solder at this temperature must not be in contact with the joint for more than 5 seconds. The total contact time of successive solder waves must not exceed 5 seconds.

The device may be mounted up to the seating plane, but the temperature of the plastic body must not exceed the specified maximum storage temperature ($T_{stg\ max}$). If the printed-circuit board has been pre-heated, forced cooling may be necessary immediately after soldering to keep the temperature within the permissible limit.

Repairing soldered joints

Apply a low voltage soldering iron (less than 24 V) to the lead(s) of the package, below the seating plane or not more than 2 mm above it. If the temperature of the soldering iron bit is less than 300 °C it may remain in contact for up to 10 seconds. If the bit temperature is between 300 and 400 °C, contact may be up to 5 seconds.

DEFINITIONS

Data sheet status	
Objective specification	This data sheet contains target or goal specifications for product development.
Preliminary specification	This data sheet contains preliminary data; supplementary data may be published later.
Product specification	This data sheet contains final product specifications.
Limiting values	
Limiting values given are in accordance with the Absolute Maximum Rating System (IEC 134). Stress above one or more of the limiting values may cause permanent damage to the device. These are stress ratings only and operation of the device at these or at any other conditions above those given in the Characteristics sections of the specification is not implied. Exposure to limiting values for extended periods may affect device reliability.	
Application information	
Where application information is given, it is advisory and does not form part of the specification.	

LIFE SUPPORT APPLICATIONS

These products are not designed for use in life support appliances, devices, or systems where malfunction of these products can reasonably be expected to result in personal injury. Philips customers using or selling these products for use in such applications do so at their own risk and agree to fully indemnify Philips for any damages resulting from such improper use or sale.