

## Base strip - DFK-MSTB 2,5/ 8-G - 0707060

Please be informed that the data shown in this PDF Document is generated from our Online Catalog. Please find the complete data in the user's documentation. Our General Terms of Use for Downloads are valid (<http://download.phoenixcontact.com>)



Plug component, Nominal current: 12 A, Rated voltage (III/2): 320 V, Number of positions: 8, Pitch: 5 mm, Connection method: Solder/Slip-on connection, Color: green, Contact surface: Tin, Assembly: Direct mounting, Accessory order no. 5030172 can only be used in conjunction with MSTB 2,5/...ST and MSTBT 2,5/...ST.

The figure shows a 10-position version of the product

### Why buy this product

- Outside: plug-in connection for corresponding MSTB 2,5 or FKC 2,5 plugs
- Can be fixed in housing panels up to 6 mm thick using two M3 x 10 screws
- Inside: solder or 2.8 mm slip-on plug-in connection that can be combined
- Headers for assembly in a device/housing panel



### Key commercial data

Packing unit	1
Minimum order quantity	50
Catalog page	Page 324 (CC-2011)
GTIN	 4 017918 003845
Custom tariff number	85366990
Country of origin	GERMANY

### Technical data

#### Dimensions / positions

Pitch	5 mm
Dimension a	35 mm
Number of positions	8

#### Technical data

Range of articles	DFK-MSTB 2,5/..-G
Insulating material group	I
Rated surge voltage (III/3)	4 kV
Rated surge voltage (III/2)	4 kV
Rated surge voltage (II/2)	4 kV
Rated voltage (III/2)	320 V

## Base strip - DFK-MSTB 2,5/ 8-G - 0707060

### Technical data

#### Technical data

Rated voltage (II/2)	630 V
Connection in acc. with standard	EN-VDE
Nominal current I <sub>N</sub>	12 A
Nominal voltage U <sub>N</sub>	320 V
Nominal cross section	2.5 mm <sup>2</sup>
Maximum load current	12 A
Insulating material	PA
Inflammability class according to UL 94	V2
Nominal voltage, UL/CUL Use Group B	300 V
Nominal current, UL/CUL Use Group B	15 A
Nominal voltage, UL/CUL Use Group D	300 V
Nominal current, UL/CUL Use Group D	15 A

#### Connection data

Conductor cross section solid min.	0.2 mm <sup>2</sup>
Conductor cross section solid max.	2.5 mm <sup>2</sup>
Conductor cross section stranded min.	0.2 mm <sup>2</sup>
Conductor cross section stranded max.	2.5 mm <sup>2</sup>
Conductor cross section AWG/kcmil min.	24
Conductor cross section AWG/kcmil max	12

### Classifications

#### eClass

eCl@ss 4.0	272607xx
eCl@ss 4.1	27260701
eCl@ss 5.0	27260701
eCl@ss 5.1	27141190
eCl@ss 6.0	27260704
eCl@ss 7.0	27440402

#### etim

ETIM 3.0	EC001283
ETIM 4.0	EC001283
ETIM 5.0	EC001283

#### unspsc

UNSPSC 6.01	30211810
UNSPSC 7.0901	39121409
UNSPSC 11	39121409
UNSPSC 12.01	39121409
UNSPSC 13.2	39121409

# Base strip - DFK-MSTB 2,5/ 8-G - 0707060

## Approvals

### Approvals

---

#### Approvals

CSA / UL Recognized / VDE report with production monitoring / cUL Recognized / GOST / IECEE CB Scheme / GOST / cULus Recognized

---

#### Ex Approvals

---

#### Approvals submitted

---

### Approval details

CSA 		
	B	D
Nominal current IN	10 A	10 A
Nominal voltage UN	300 V	300 V

UL Recognized 		
	B	D
Nominal current IN	15 A	15 A
Nominal voltage UN	300 V	150 V

VDE report with production monitoring 		
Nominal current IN	12 A	
Nominal voltage UN	250 V	

cUL Recognized 		
	B	D
Nominal current IN	15 A	15 A
Nominal voltage UN	300 V	150 V

## Base strip - DFK-MSTB 2,5/ 8-G - 0707060

### Approvals



IECEE CB Scheme	
Nominal current I <sub>N</sub>	12 A
Nominal voltage U <sub>N</sub>	250 V



### Accessories

Accessories

Assembly

Screw set - DFK-MSTB-SS - 0708263



Screw set, for securing the header to the device wall, consists of an M3 x 10 screw, with a spring washer and a nut

Accessories - MSTB-BL - 1755477



Keying cap, for forming sections, plugs onto header pin, green insulating material

Accessories - DFK-MSTB-R - 5030172



Locking latch, red insulating material, for housings MSTB 2.5/...ST and MSTBT 2.5/...ST

## Base strip - DFK-MSTB 2,5/ 8-G - 0707060

### Accessories

#### Plug/Adapter

Keying star - CR-MSTB - 1734401



Coding section, inserted into the recess in the header or the inverted plug, red insulating material

---

### Additional products

Printed-circuit board connector - FKCT 2,5/ 8-ST - 1909278



Plug component, Nominal current: 12 A, Rated voltage (III/2): 320 V, Number of positions: 8, Pitch: 5 mm, Connection method: Spring-cage conn., Color: green, Contact surface: Tin

---

Printed-circuit board connector - FKCVR 2,5/ 8-ST - 1909773

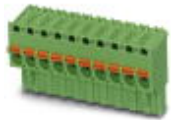

Plug component, Nominal current: 12 A, Rated voltage (III/2): 320 V, Number of positions: 8, Pitch: 5 mm, Connection method: Spring-cage conn., Color: green, Contact surface: Tin

---

Printed-circuit board connector - FKCVW 2,5/ 8-ST - 1910092



Plug component, Nominal current: 12 A, Rated voltage (III/2): 320 V, Number of positions: 8, Pitch: 5 mm, Connection method: Spring-cage conn., Color: green, Contact surface: Tin

---

Plug - SMSTB 2,5/ 8-ST - 1768448



Plug component, Nominal current: 12 A, Rated voltage (III/2): 320 V, Number of positions: 8, Pitch: 5 mm, Connection method: Screw connection, Color: green, Contact surface: Tin

## Base strip - DFK-MSTB 2,5/ 8-G - 0707060

### Accessories

Printed-circuit board connector - FKC 2,5/ 8-ST - 1910416



Plug component, Nominal current: 12 A, Rated voltage (III/2): 320 V, Number of positions: 8, Pitch: 5 mm, Connection method: Spring-cage conn., Color: green, Contact surface: Tin

Printed-circuit board connector - MVSTBW 2,5/ 8-ST - 1792582



Plug component, Nominal current: 12 A, Rated voltage (III/2): 320 V, Number of positions: 8, Pitch: 5 mm, Connection method: Screw connection, Color: green, Contact surface: Tin

Printed-circuit board connector - MVSTBR 2,5/ 8-ST - 1792074



Plug component, Nominal current: 12 A, Rated voltage (III/2): 320 V, Number of positions: 8, Pitch: 5 mm, Connection method: Screw connection, Color: green, Contact surface: Tin

Printed-circuit board connector - MSTBT 2,5/ 8-ST - 1779893



Plug component, Nominal current: 12 A, Rated voltage (III/2): 320 V, Number of positions: 8, Pitch: 5 mm, Connection method: Screw connection, Color: green, Contact surface: Tin

Printed-circuit board connector - FRONT-MSTB 2,5/ 8-ST - 1779479



Plug component, Nominal current: 12 A, Rated voltage (III/2): 320 V, Number of positions: 8, Pitch: 5 mm, Connection method: Screw connection, Color: green, Contact surface: Tin

Printed-circuit board connector - MSTBP 2,5/ 8-ST - 1765836



Plug component, Nominal current: 12 A, Rated voltage (III/2): 320 V, Number of positions: 8, Pitch: 5 mm, Connection method: Screw connection, Color: green, Contact surface: Tin

## Base strip - DFK-MSTB 2,5/ 8-G - 0707060

### Accessories

---

Printed-circuit board connector - MSTB 2,5/ 8-STZ - 1758982



Plug component, Nominal current: 12 A, Rated voltage (III/2): 320 V, Number of positions: 8, Pitch: 5 mm, Connection method: Screw connection, Color: green, Contact surface: Tin

---

Printed-circuit board connector - MSTB 2,5/ 8-ST - 1754562



Plug component, Nominal current: 12 A, Rated voltage (III/2): 320 V, Number of positions: 8, Pitch: 5 mm, Connection method: Screw connection, Color: green, Contact surface: Tin

---

### Drawings

Drilling diagram

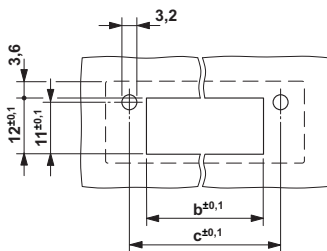

Dimension b: 2.7 mm + (no. of pos. x 5.0 mm)

Dimension c: Dim. b + 7.3 mm

# Base strip - DFK-MSTB 2,5/ 8-G - 0707060

Dimensioned drawing

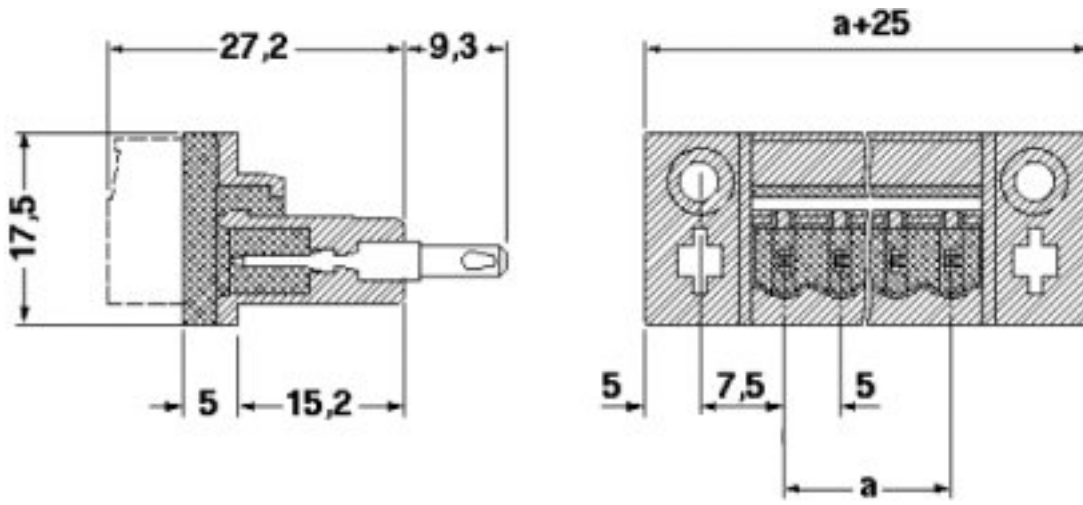

© Phoenix Contact 2012 - all rights reserved  
<http://www.phoenixcontact.com>