

# SN54LS422, SN54LS423, SN74LS422, SN74LS423 RETRIGGERABLE MONOSTABLE MULTIVIBRATORS

SDLS175 D2536, JANUARY 1980 — REVISED MARCH 1988

- Will Not Trigger from Clear
- D-C Triggered from Active-High or Active-Low Gated Logic Inputs
- Retriggerable for Very Long Output Pulses, Up to 100% Duty Cycle
- Overriding Clear Terminates Output Pulse
- 'LS422 Has Internal Timing Resistor

## description

The 'LS422 and 'LS423 are identical to 'LS122 and 'LS123 except they cannot be triggered via clear.

These d-c triggered multivibrators feature output-pulse-width control by three methods. The basic pulse time is programmed by selection of external resistance and capacitance values (see typical application data). The 'LS422 contains an internal timing resistor that allows the circuits to be used with only an external capacitor, if so desired. Once triggered, the basic pulse width may be extended by retriggering the gated low-level-active (A) or high-level-active (B) inputs, or be reduced by use of the overriding clear. Figure 1 illustrates pulse control by retriggering and early clear.

The 'LS422 and 'LS423 have enough Schmitt hysteresis to ensure jitter-free triggering from the B input with transition rates as slow as 0.1 millivolt per nanosecond. The 'LS422  $R_{int}$  is nominally 10 k ohms.

The SN54LS422 and SN54LS423 are characterized for operation over the full military temperature range of  $-55^{\circ}\text{C}$  to  $125^{\circ}\text{C}$ . The SN74LS422 and SN74LS423 are characterized for operation from  $0^{\circ}\text{C}$  to  $70^{\circ}\text{C}$ .

SN54LS423 . . . J OR W PACKAGE  
SN74LS423 . . . D OR N PACKAGE  
(TOP VIEW) (SEE NOTES 1 THRU 4)

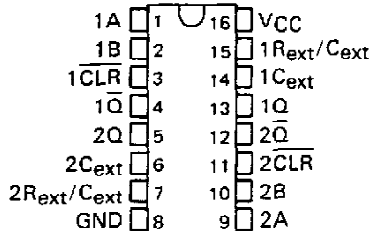

SN54LS422 . . . J OR W PACKAGE  
SN74LS422 . . . D OR N PACKAGE  
(TOP VIEW) (SEE NOTES 1 THRU 4)

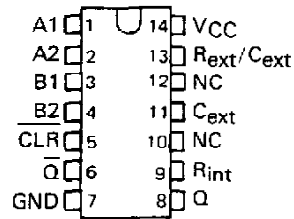

SN54LS422 . . . FK PACKAGE  
(TOP VIEW) (SEE NOTES 1 THRU 4)

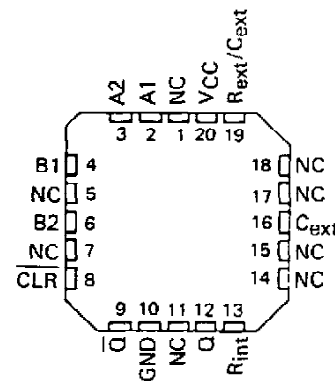

SN54LS423 . . . FK PACKAGE  
(TOP VIEW) (SEE NOTES 1 THRU 4)

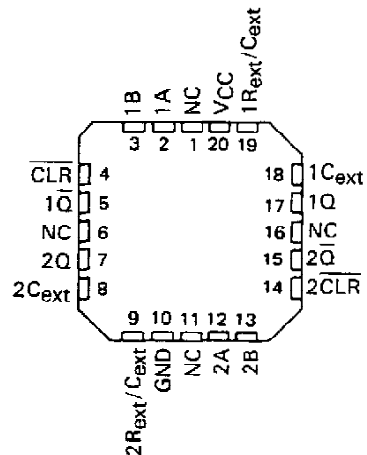

- NOTES: 1. An external timing capacitor may be connected between  $C_{ext}$  and  $R_{ext}/C_{ext}$  (positive).  
 2. To use the internal timing resistor of 'LS422, connect  $R_{int}$  to  $V_{CC}$ .  
 3. For improved pulse width accuracy and repeatability, connect an external resistor between  $R_{ext}/C_{ext}$  and  $V_{CC}$  with  $R_{int}$  open-circuited.  
 4. To obtain variable pulse widths, connect an external variable resistance between  $R_{int}$  or  $R_{ext}/C_{ext}$  and  $V_{CC}$ .

PRODUCTION DATA documents contain information current as of publication date. Products conform to specifications per the terms of Texas Instruments standard warranty. Production processing does not necessarily include testing of all parameters.

TEXAS  
INSTRUMENTS

POST OFFICE BOX 655012 • DALLAS, TEXAS 75265

# SN54LS422, SN54LS423, SN74LS422, SN74LS423 RETRIGGERABLE MONOSTABLE MULTIVIBRATORS

description (continued)

LS422 FUNCTION TABLE							LS423 FUNCTION TABLE					
INPUTS						OUTPUTS		INPUTS			OUTPUTS	
CLEAR	A1	A2	B1	B2	Q	$\bar{Q}$	CLEAR	A	B	Q	$\bar{Q}$	
L	X	X	X	X	L	H	L	X	X	L	H	
X	H	H	X	X	L↑	H↑	X	H	X	L↑	H↑	
X	X	X	L	X	L↑	H↑	X	X	L	L↑	H↑	
X	X	X	X	L	L↑	H↑	H	L	↑	↓	↑	
H	L	X	↑	H	↓	↑	H	X	L	↑	H	
H	L	X	H	↑	↓	↑	H	X	L	H	↑	
H	X	L	↑	H	↓	↑	X	H	↓	H	H	
H	X	L	H	↑	↓	↑	X	↓	↓	H	H	
H	↓	↓	H	H	↓	↑	H	↓	H	H	H	
H	↓	H	H	H	↓	↑	H	↓	H	H	H	

† These lines of the functional tables assume that the indicated steady-state conditions at the A and B inputs have been set up long enough to complete any pulse started before the set up.

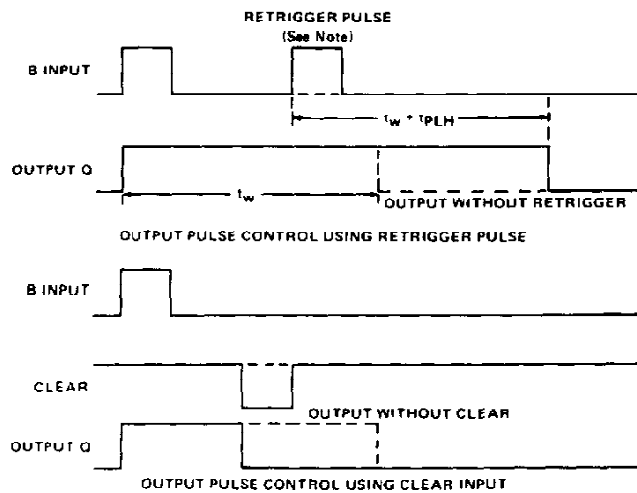

NOTE: Retrigger pulses starting before  $0.22 C_{ext}$  (in picofrads) nanoseconds after the initial trigger pulse will be ignored and the output pulse will remain unchanged.

FIGURE 1—TYPICAL INPUT/OUTPUT PULSES

# SN54LS422, SN54LS423, SN74LS422, SN74LS423 RETRIGGERABLE MONOSTABLE MULTIVIBRATORS

## logic symbols†

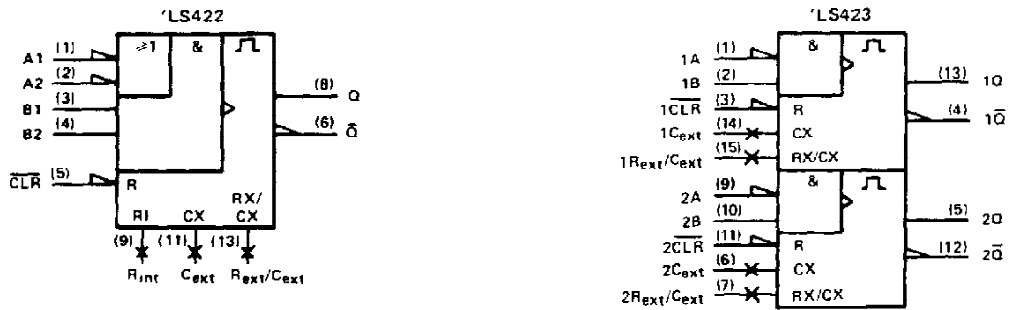

† These symbols are in accordance with ANSI/IEEE Std 91-1984 and IEC Publication 617-12.

## logic diagrams (positive logic)

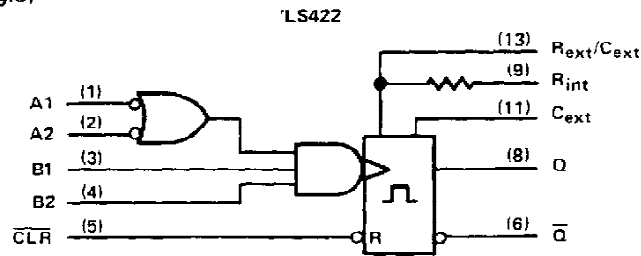

$R_{int}$  is nominally 10 k ohms

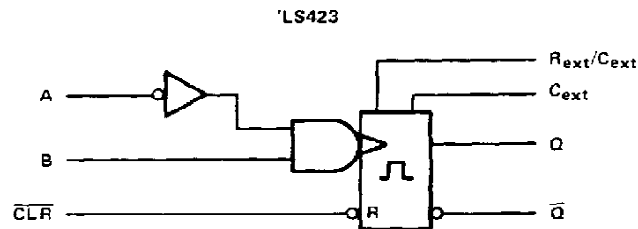

Pin numbers shown are for D, J, N, and W packages.

## schematics of inputs and outputs

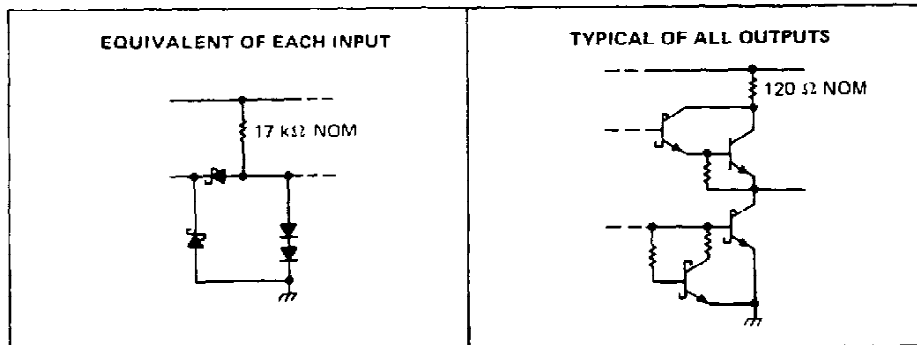

# SN54LS422, SN54LS423, SN74LS422, SN74LS423 RETRIGGERABLE MONOSTABLE MULTIVIBRATORS

## recommended operating conditions

	SN54LS*			SN74LS*			UNIT
	MIN	NOM	MAX	MIN	NOM	MAX	
Supply voltage, $V_{CC}$	4.5	5	5.5	4.75	5	5.25	V
High-level output current, $I_{OH}$			-400			-400	$\mu$ A
Low-level output current, $I_{OL}$			4			8	mA
Pulse width, $t_W$	40			40			ns
External timing resistance, $R_{ext}$	5		180	5		260	k $\Omega$
External capacitance, $C_{ext}$	No restriction			No restriction			
Wiring capacitance at $R_{ext}/C_{ext}$ terminal	50			50			pF
Operating free-air temperature, $T_A$	-55		125	0		70	$^{\circ}$ C

## electrical characteristics over recommended operating free-air temperature range (unless otherwise noted)

PARAMETER	TEST CONDITIONS†	SN54LS*			SN74LS*			UNIT	
		MIN	TYP‡	MAX	MIN	TYP‡	MAX		
$V_{IH}$ High-level input voltage		2			2			V	
$V_{IL}$ Low-level input voltage				0.7			0.8	V	
$V_{IK}$ Input clamp voltage	$V_{CC} = \text{MIN}$ , $I_I = -18 \text{ mA}$			-1.5			-1.5	V	
$V_{OH}$ High-level output voltage	$V_{CC} = \text{MIN}$ , $V_{IH} = 2 \text{ V}$ , $V_{IL} = V_{IL \text{ max}}$ , $I_{OH} = 400 \mu\text{A}$	2.5	3.5		2.7	3.5		V	
$V_{OL}$ Low-level output voltage	$V_{CC} = \text{MIN}$ , $V_{IH} = 2 \text{ V}$ , $V_{IL} = V_{IL \text{ max}}$			0.25	0.4		0.25	0.4	V
							0.35	0.5	
$I_I$ Input current at maximum input voltage	$V_{CC} = \text{MAX}$ , $V_I = 7 \text{ V}$			0.1			0.1	mA	
$I_{IH}$ High-level input current	$V_{CC} = \text{MAX}$ , $V_I = 2.7 \text{ V}$			20			20	$\mu$ A	
$I_{IL}$ Low-level input current	$V_{CC} = \text{MAX}$ , $V_I = 0.4 \text{ V}$			-0.4			-0.4	mA	
$I_{OS}$ Short-circuit output current §	$V_{CC} = \text{MAX}$	-20		-100	-20		-100	mA	
$I_{CC}$ Supply current (quiescent or triggered)	$V_{CC} = \text{MAX}$ , See Note 6			6	11		6	11	mA
				12	20		12	20	

† For conditions shown as MIN or MAX, use the appropriate value specified under recommended operating conditions.

‡ All typical values are at  $V_{CC} = 5 \text{ V}$ ,  $T_A = 25^{\circ}\text{C}$ .

§ Not more than one output should be shorted at a time and duration of the short-circuit should not exceed one second.

NOTES: 5. To measure  $V_{OH}$  at Q,  $V_{OL}$  at  $\bar{Q}$ , or  $I_{OS}$  at Q, ground  $R_{ext}/C_{ext}$ , apply 2 V to B and clear, and pulse A from 2 V to 0 V.  
6. With all outputs open and 4.5 V applied to all data and clear inputs,  $I_{CC}$  is measured after a momentary ground, then 4.5 V, is applied to clock.

## switching characteristics, $V_{CC} = 5 \text{ V}$ , $T_A = 25^{\circ}\text{C}$ , see note 7

PARAMETER¶	FROM (INPUT)	TO (OUTPUT)	TEST CONDITIONS	MIN	TYP	MAX	UNIT
$t_{PLH}$	A	Q	$C_{ext} = 0$ , $R_{ext} = 5 \text{ k}\Omega$ , $C_L = 15 \text{ pF}$ , $R_L = 2 \text{ k}\Omega$		23	33	ns
	B	Q			23	44	
$t_{PHL}$	A	$\bar{Q}$			32	45	ns
	B	$\bar{Q}$			34	56	
$t_{PHL}$	Clear	Q			20	27	ns
$t_{PLH}$	Clear	$\bar{Q}$			28	45	ns
$t_{wQ}(\text{min})$	A or B	Q		116	200	ns	
$t_{wQ}$	A or B	Q	$C_{ext} = 1000 \text{ pF}$ , $R_{ext} = 10 \text{ k}\Omega$ , $C_L = 15 \text{ pF}$ , $R_L = 2 \text{ k}\Omega$	4	4.5	5	$\mu$ s

¶  $t_{wQ}$  = width of pulse output Q.

NOTE 7: Load circuits and voltage waveforms are shown in Section 1.

TEXAS  
INSTRUMENTS

POST OFFICE BOX 655012 • DALLAS, TEXAS 75265

# SN54LS422, SN54LS423, SN74LS422, SN74LS423 RETRIGGERABLE MONOSTABLE MULTIVIBRATORS

## TYPICAL APPLICATION DATA FOR 'LS422, 'LS423†

The basic output pulse width is essentially determined by the values of external capacitance and timing resistance. For pulse widths when  $C_{ext} \leq 1000$  pF, use Figure 3. For  $C_{ext}$  between 0.1 nF and 1  $\mu$ F, the pulse width may be defined as:

$$t_w \approx K \cdot R_T \cdot C_{ext}$$

with K obtained from Figure 4.

When  $C_{ext} \geq 1$   $\mu$ F, the output pulse width is defined as:

$$t_w \approx 0.33 \cdot R_T \cdot C_{ext}$$

Where

$R_T$  is in kilohms (internal or external timing resistance)

$C_{ext}$  is in pF

$t_w$  is in nanoseconds

For maximum noise immunity, system ground should be applied to the  $C_{ext}$  node, even though the  $C_{ext}$  node is already tied to the ground lead internally. Due to the timing scheme used by the 'LS422 and 'LS423, a switching diode is not required to prevent reverse biasing when using electrolytic capacitors.

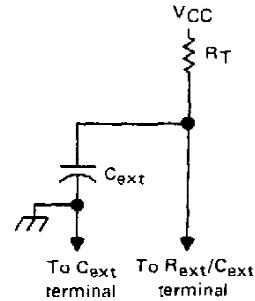

TIMING COMPONENT CONNECTIONS  
FIGURE 2

### 'LS422, 'LS423 TYPICAL OUTPUT PULSE WIDTH vs EXTERNAL TIMING CAPACITANCE

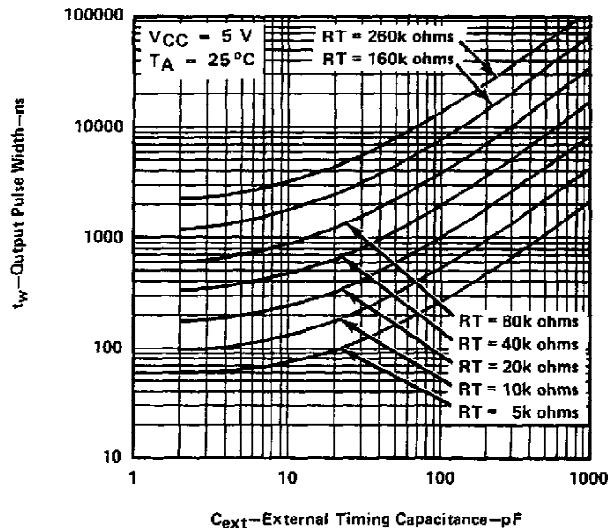

† This value of resistance exceeds the maximum recommended for use over the full temperature range of the SN54LS circuits.

FIGURE 3

TEXAS  
INSTRUMENTS

POST OFFICE BOX 655012 • DALLAS, TEXAS 75265

**SN54LS422, SN54LS423, SN74LS422, SN74LS423  
RETRIGGERABLE MONOSTABLE MULTIVIBRATORS**

**TYPICAL APPLICATION DATA FOR 'LS422, 'LS423 †**

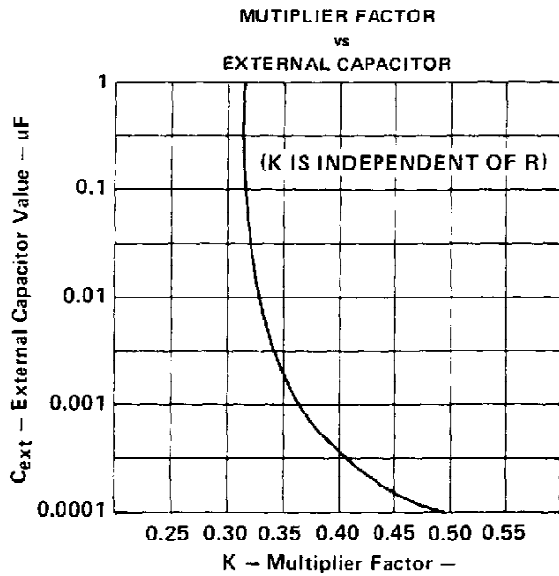

**FIGURE 4**

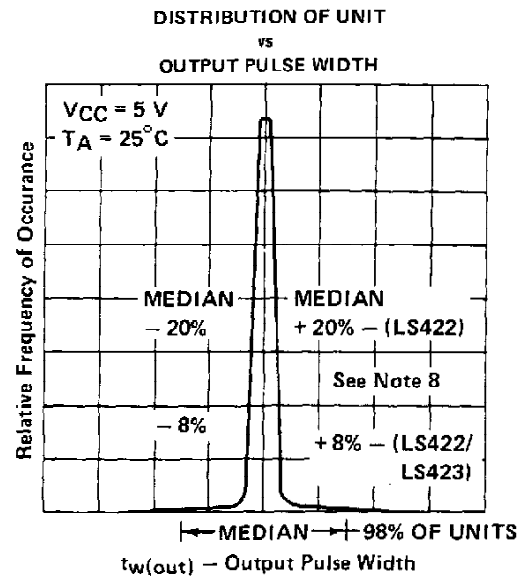

**FIGURE 5**

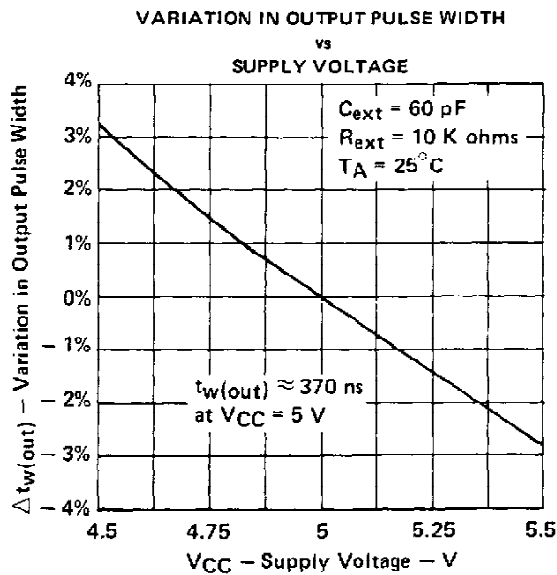

**FIGURE 6**

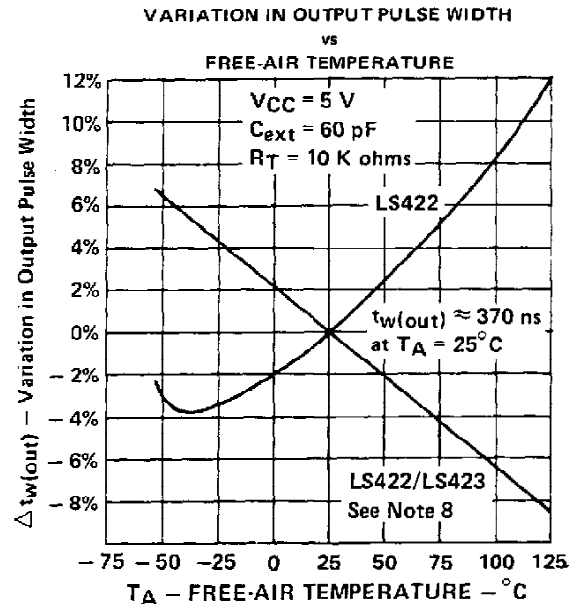

**FIGURE 7**

NOTE 8: For the LS422, the internal timing resistor, R<sub>int</sub> was used. For the LS422/423, an external timing resistor was used for R<sub>T</sub>.  
† Data for temperatures below 0°C and above 70°C and for supply voltages below 4.75 V and above 5.25 V are applicable for SN54LS422 and SN54LS423 only.

**TEXAS  
INSTRUMENTS**

POST OFFICE BOX 655012 • DALLAS, TEXAS 75265

## IMPORTANT NOTICE

Texas Instruments (TI) reserves the right to make changes to its products or to discontinue any semiconductor product or service without notice, and advises its customers to obtain the latest version of relevant information to verify, before placing orders, that the information being relied on is current.

TI warrants performance of its semiconductor products and related software to the specifications applicable at the time of sale in accordance with TI's standard warranty. Testing and other quality control techniques are utilized to the extent TI deems necessary to support this warranty. Specific testing of all parameters of each device is not necessarily performed, except those mandated by government requirements.

Certain applications using semiconductor products may involve potential risks of death, personal injury, or severe property or environmental damage ("Critical Applications").

TI SEMICONDUCTOR PRODUCTS ARE NOT DESIGNED, INTENDED, AUTHORIZED, OR WARRANTED TO BE SUITABLE FOR USE IN LIFE-SUPPORT APPLICATIONS, DEVICES OR SYSTEMS OR OTHER CRITICAL APPLICATIONS.

Inclusion of TI products in such applications is understood to be fully at the risk of the customer. Use of TI products in such applications requires the written approval of an appropriate TI officer. Questions concerning potential risk applications should be directed to TI through a local SC sales office.

In order to minimize risks associated with the customer's applications, adequate design and operating safeguards should be provided by the customer to minimize inherent or procedural hazards.

TI assumes no liability for applications assistance, customer product design, software performance, or infringement of patents or services described herein. Nor does TI warrant or represent that any license, either express or implied, is granted under any patent right, copyright, mask work right, or other intellectual property right of TI covering or relating to any combination, machine, or process in which such semiconductor products or services might be or are used.

## **IMPORTANT NOTICE**

Texas Instruments (TI) reserves the right to make changes to its products or to discontinue any semiconductor product or service without notice, and advises its customers to obtain the latest version of relevant information to verify, before placing orders, that the information being relied on is current.

TI warrants performance of its semiconductor products and related software to the specifications applicable at the time of sale in accordance with TI's standard warranty. Testing and other quality control techniques are utilized to the extent TI deems necessary to support this warranty. Specific testing of all parameters of each device is not necessarily performed, except those mandated by government requirements.

Certain applications using semiconductor products may involve potential risks of death, personal injury, or severe property or environmental damage ("Critical Applications").

**TI SEMICONDUCTOR PRODUCTS ARE NOT DESIGNED, INTENDED, AUTHORIZED, OR WARRANTED TO BE SUITABLE FOR USE IN LIFE-SUPPORT APPLICATIONS, DEVICES OR SYSTEMS OR OTHER CRITICAL APPLICATIONS.**

Inclusion of TI products in such applications is understood to be fully at the risk of the customer. Use of TI products in such applications requires the written approval of an appropriate TI officer. Questions concerning potential risk applications should be directed to TI through a local SC sales office.

In order to minimize risks associated with the customer's applications, adequate design and operating safeguards should be provided by the customer to minimize inherent or procedural hazards.

TI assumes no liability for applications assistance, customer product design, software performance, or infringement of patents or services described herein. Nor does TI warrant or represent that any license, either express or implied, is granted under any patent right, copyright, mask work right, or other intellectual property right of TI covering or relating to any combination, machine, or process in which such semiconductor products or services might be or are used.



**TAPE AND REEL INFORMATION**



**QUADRANT ASSIGNMENTS FOR PIN 1 ORIENTATION IN TAPE**



\*All dimensions are nominal

Device	Package Type	Package Drawing	Pins	SPQ	Reel Diameter (mm)	Reel Width W1 (mm)	A0 (mm)	B0 (mm)	K0 (mm)	P1 (mm)	W (mm)	Pin1 Quadrant
SN74LS423DR	SOIC	D	16	2500	330.0	16.4	6.5	10.3	2.1	8.0	16.0	Q1
SN74LS423NSR	SO	NS	16	2000	330.0	16.4	8.2	10.5	2.5	12.0	16.0	Q1

**TAPE AND REEL BOX DIMENSIONS**



\*All dimensions are nominal

Device	Package Type	Package Drawing	Pins	SPQ	Length (mm)	Width (mm)	Height (mm)
SN74LS423DR	SOIC	D	16	2500	333.2	345.9	28.6
SN74LS423NSR	SO	NS	16	2000	346.0	346.0	33.0

## IMPORTANT NOTICE

Texas Instruments Incorporated and its subsidiaries (TI) reserve the right to make corrections, modifications, enhancements, improvements, and other changes to its products and services at any time and to discontinue any product or service without notice. Customers should obtain the latest relevant information before placing orders and should verify that such information is current and complete. All products are sold subject to TI's terms and conditions of sale supplied at the time of order acknowledgment.

TI warrants performance of its hardware products to the specifications applicable at the time of sale in accordance with TI's standard warranty. Testing and other quality control techniques are used to the extent TI deems necessary to support this warranty. Except where mandated by government requirements, testing of all parameters of each product is not necessarily performed.

TI assumes no liability for applications assistance or customer product design. Customers are responsible for their products and applications using TI components. To minimize the risks associated with customer products and applications, customers should provide adequate design and operating safeguards.

TI does not warrant or represent that any license, either express or implied, is granted under any TI patent right, copyright, mask work right, or other TI intellectual property right relating to any combination, machine, or process in which TI products or services are used. Information published by TI regarding third-party products or services does not constitute a license from TI to use such products or services or a warranty or endorsement thereof. Use of such information may require a license from a third party under the patents or other intellectual property of the third party, or a license from TI under the patents or other intellectual property of TI.

Reproduction of TI information in TI data books or data sheets is permissible only if reproduction is without alteration and is accompanied by all associated warranties, conditions, limitations, and notices. Reproduction of this information with alteration is an unfair and deceptive business practice. TI is not responsible or liable for such altered documentation. Information of third parties may be subject to additional restrictions.

Resale of TI products or services with statements different from or beyond the parameters stated by TI for that product or service voids all express and any implied warranties for the associated TI product or service and is an unfair and deceptive business practice. TI is not responsible or liable for any such statements.

TI products are not authorized for use in safety-critical applications (such as life support) where a failure of the TI product would reasonably be expected to cause severe personal injury or death, unless officers of the parties have executed an agreement specifically governing such use. Buyers represent that they have all necessary expertise in the safety and regulatory ramifications of their applications, and acknowledge and agree that they are solely responsible for all legal, regulatory and safety-related requirements concerning their products and any use of TI products in such safety-critical applications, notwithstanding any applications-related information or support that may be provided by TI. Further, Buyers must fully indemnify TI and its representatives against any damages arising out of the use of TI products in such safety-critical applications.

TI products are neither designed nor intended for use in military/aerospace applications or environments unless the TI products are specifically designated by TI as military-grade or "enhanced plastic." Only products designated by TI as military-grade meet military specifications. Buyers acknowledge and agree that any such use of TI products which TI has not designated as military-grade is solely at the Buyer's risk, and that they are solely responsible for compliance with all legal and regulatory requirements in connection with such use.

TI products are neither designed nor intended for use in automotive applications or environments unless the specific TI products are designated by TI as compliant with ISO/TS 16949 requirements. Buyers acknowledge and agree that, if they use any non-designated products in automotive applications, TI will not be responsible for any failure to meet such requirements.

Following are URLs where you can obtain information on other Texas Instruments products and application solutions:

### Products

Amplifiers	<a href="http://amplifier.ti.com">amplifier.ti.com</a>
Data Converters	<a href="http://dataconverter.ti.com">dataconverter.ti.com</a>
DSP	<a href="http://dsp.ti.com">dsp.ti.com</a>
Clocks and Timers	<a href="http://www.ti.com/clocks">www.ti.com/clocks</a>
Interface	<a href="http://interface.ti.com">interface.ti.com</a>
Logic	<a href="http://logic.ti.com">logic.ti.com</a>
Power Mgmt	<a href="http://power.ti.com">power.ti.com</a>
Microcontrollers	<a href="http://microcontroller.ti.com">microcontroller.ti.com</a>
RFID	<a href="http://www.ti-rfid.com">www.ti-rfid.com</a>
RF/IF and ZigBee® Solutions	<a href="http://www.ti.com/lprf">www.ti.com/lprf</a>

### Applications

Audio	<a href="http://www.ti.com/audio">www.ti.com/audio</a>
Automotive	<a href="http://www.ti.com/automotive">www.ti.com/automotive</a>
Broadband	<a href="http://www.ti.com/broadband">www.ti.com/broadband</a>
Digital Control	<a href="http://www.ti.com/digitalcontrol">www.ti.com/digitalcontrol</a>
Medical	<a href="http://www.ti.com/medical">www.ti.com/medical</a>
Military	<a href="http://www.ti.com/military">www.ti.com/military</a>
Optical Networking	<a href="http://www.ti.com/opticalnetwork">www.ti.com/opticalnetwork</a>
Security	<a href="http://www.ti.com/security">www.ti.com/security</a>
Telephony	<a href="http://www.ti.com/telephony">www.ti.com/telephony</a>
Video & Imaging	<a href="http://www.ti.com/video">www.ti.com/video</a>
Wireless	<a href="http://www.ti.com/wireless">www.ti.com/wireless</a>

Mailing Address: Texas Instruments, Post Office Box 655303, Dallas, Texas 75265  
Copyright © 2008, Texas Instruments Incorporated