

DC Brushless Fan Motor Driver Series

3 Hall Sensor

3 Phase Brushless Motor Pre-driver

BM62300MUV

General Description

BM62300MUV is pre-driver IC for three-phase brushless motor driver that supports 24V power supply controlling the motor driver constructed in external power transistor. It detects the rotor position on three hall sensors. In addition, silent operation and low vibration is implemented by making the output current a sin waveform.

Features

- Supports External Power Transistor (Nch+Nch)
- Built-in Boost Voltage Circuit
- 3 Hall Sine Wave 180 degrees Electric Drive
- Automatic Lead Angle Settings
- Speed Control on PWM Input
- Soft Start Function
- Number of Pole Selection
- Current Limit Function
- Built-in Power Save Function
- Direction of Rotation Settings
- Short Break Limitation
- Built-in Several Protection Functions (High-speed rotation protection, low-speed rotation protection, over voltage protection (OVLO), under voltage lock-out (UVLO), thermal shutdown(TSD))

Application

- Fan Motor
- Motor for Pump
- Ceiling Fan
- Other General Consumer Equipment

Typical Application Circuit

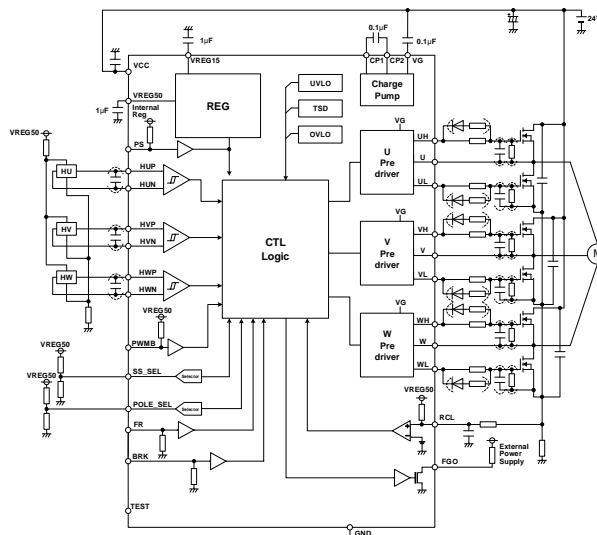

Key Specifications

- Input Voltage Range : 8 V to 28 V
- External Power Transistor Upper Gate Drive Voltage : $V_{CC} + 7.5 V(\text{Typ})$
- External Power Transistor Lower Gate Drive Voltage : 9.0 V(Typ)
- Switching Frequency : 40 kHz(Typ)
- Standby Current : 0.6 mA (Typ)
- Operating Temperature Range : -25 °C to +85 °C

Package

VQFN032V5050

W(Typ) x D(Typ) x H(Max)

5.00 mm x 5.00 mm x 1.00 mm

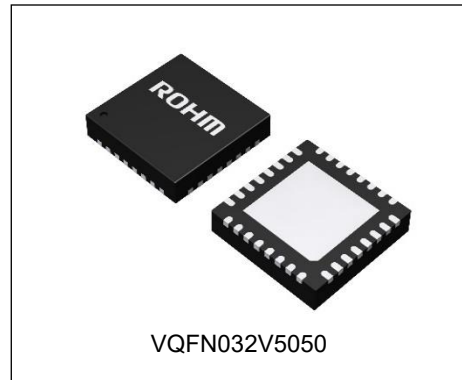

Contents

General Description.....	1
Features.....	1
Application	1
Key Specifications.....	1
Package	1
Typical Application Circuit.....	1
Pin Configurations.....	3
Pin Descriptions	3
Block Diagram.....	4
Absolute Maximum Ratings.....	5
Thermal Resistance.....	6
Recommended Operating Conditions.....	6
Electrical Characteristics	7
Application Example	9
Typical Performance Curves.....	10
Description of Function Operations.....	20
Thermal Resistance Model.....	27
I/O Equivalence Circuits.....	28
Operational Notes	29
Ordering Information.....	31
Marking Diagram.....	31
Physical Dimension and Packing Information	32
Revision History	33

Pin Configurations

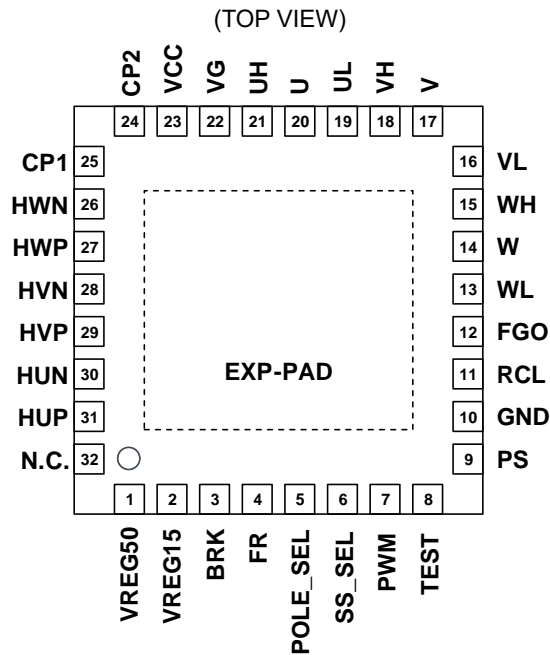

Figure 1. Pin Configurations

Pin Descriptions

Pin number	Pin name	Function	Pin number	Pin name	Function
1	VREG50	Standard voltage output	17	V	V phase external power transistor output feedback
2	VREG15	Internal power supply output for logic circuit	18	VH	V phase High side pre-driver output
3	BRK	Brakes control	19	UL	U phase Low side pre-driver output
4	FR	Rotation direction setting	20	U	U phase external power transistor output feedback
5	POLE_SEL	Setting the number of poles	21	UH	U phase High side pre-driver output
6	SS_SEL	Soft start setting	22	VG	Charge pump output
7	PWM	PWM input (positive logic)	23	VCC	Power supply
8	TEST	Test	24	CP2	Charge pump boost voltage Capacitor connection
9	PS	Power save input	25	CP1	Charge pump boost voltage Capacitor connection
10	GND	Ground	26	HWN	W phase hall input - side input
11	RCL	Output current detection voltage input	27	HWP	W phase hall input + side input
12	FGO	Rotating speed pulse signal output	28	HVN	V phase hall input - side input
13	WL	W phase Low side pre-driver output	29	HVP	V phase hall input + side input
14	W	W phase external power transistor output feedback	30	HUN	U phase hall input - side input
15	WH	W phase High side pre-driver output	31	HUP	U phase hall input + side input
16	VL	V phase Low side pre-driver output	32	N.C.	N.C.
Back side	EXP-PAD	Connect the EXP-PAD to GND			

Block Diagram

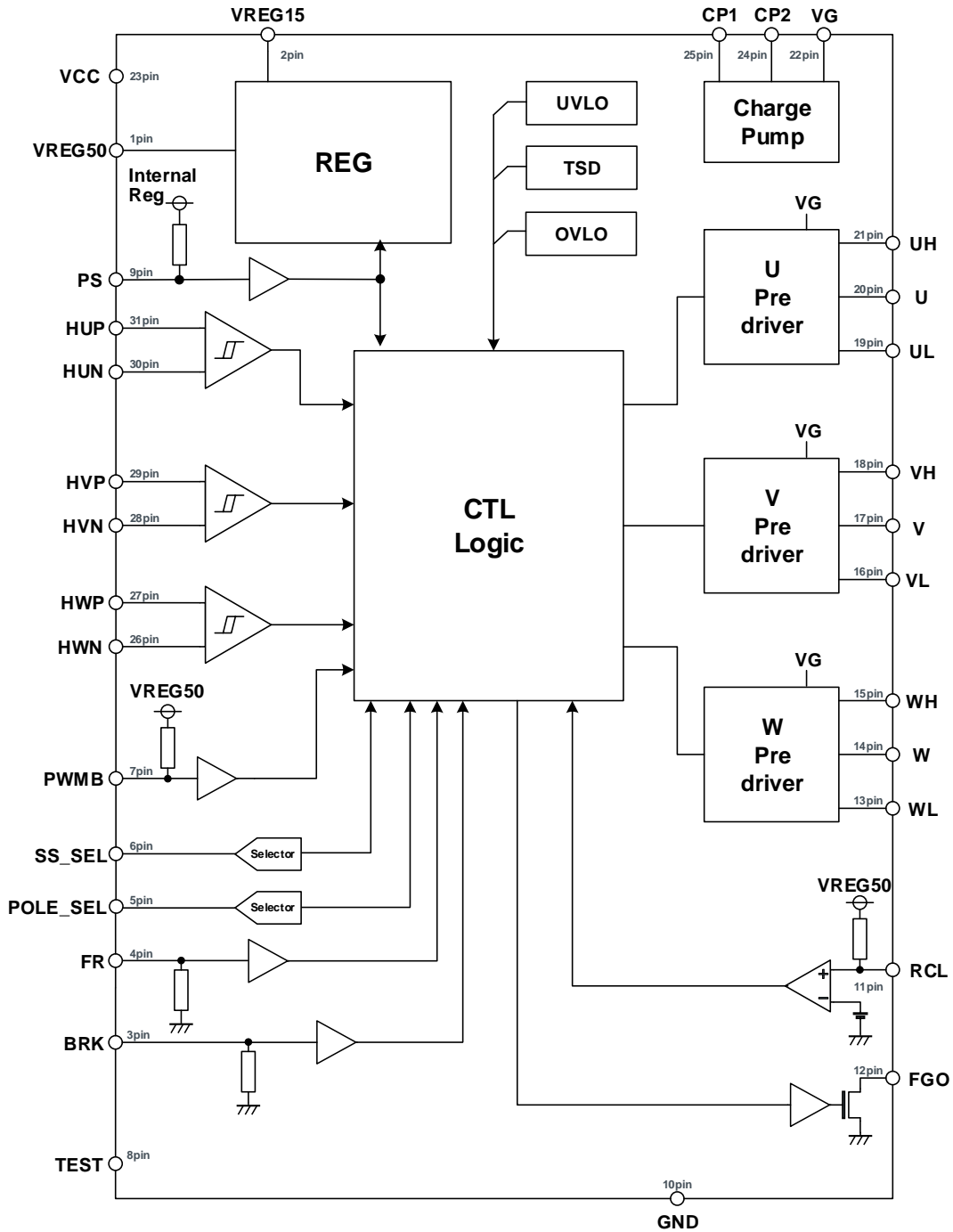

Figure 2. Block Diagram

Absolute Maximum Ratings (Ta=25°C)

Parameters	Symbol	Rating	Unit
Power Supply Voltage [VCC]	V _{CC}	33	V
VG Voltage	V _G	40	V
Pre-driver High side Output Voltage (UH,VH,WH)	V _{OH}	40	V
Pre-driver Low side Output Voltage (UL,VL,WL)	V _{OL}	12	V
Pre-driver Output-current (consecutive) (UH,VH,WH,UL,VL,WL)	I _{OMAX1}	±10	mA
Pre-driver Output-current (consecutive) (peak[<1μs]) (UH,VH,WH,UL,VL,WL)	I _{OMAX2}	±150	mA
External Power Transistor Output Feedback Voltage (U,V,W)	V _{FB}	33	V
FGO Pin Voltage	V _{FGO}	33	V
FGO Pin Current	I _{FGO}	10	mA
Reference Voltage Output Current (VREG50)	I _{VREG50}	-30	mA
RCL Pin Voltage	V _{RCL}	4.5	V
Control Input Pin Voltage ^(Note 1)	V _{IN1}	7	V
Hall Input Pin Voltage ^(Note 2)	V _{IN2}	7	V
Maximum Junction Temperature	T _{jmax}	150	°C
Storage Temperature Range	T _{stg}	-55 to +150	°C

Caution 1: Operating the IC over the absolute maximum ratings such as application voltage and temperature range may damage the IC. The damage can either be a short circuit between pins or an open circuit between pins and the internal circuitry. Therefore, it is important to consider circuit protection measures, such as adding a fuse, in case the IC operates over the absolute maximum ratings.

Caution 2: Should by any chance the maximum junction temperature rating be exceeded the rise in temperature of the chip may result in deterioration of the properties of the chip. In case of exceeding this absolute maximum rating, design a PCB with thermal resistance taken into consideration by increasing board size and copper area so as not to exceed the maximum junction temperature rating.

(Note 1) FR, SS_SEL, POLE_SEL, PWM, TEST, PS, BRK pins

(Note 2) HUP, HUN, HVP, HVN, HWP, HWN pins

Thermal Resistance (Note 3)

Parameter	Symbol	Thermal Resistance (Typ)		Unit
		1s ^(Note 5)	2s2p ^(Note 6)	
VQFN032V5050				
Junction to Ambient	θ_{JA}	138.9	39.1	°C/W
Junction to Top Characterization Parameter (Note 4)	Ψ_{JT}	11	5	°C/W

(Note 3) Based on JESD51-2A(Still-Air).

(Note 4) The thermal characterization parameter to report the difference between junction temperature and the temperature at the top center of the outside surface of the component package.

(Note 5) Use a PCB board based on JESD51-3.

(Note 6) Use a PCB board based on JESD51-5, 7.

Layer Number of Measurement Board	Material	Board Size
Single	FR-4	114.3 mm x 76.2 mm x 1.57 mmt

Top	
Copper Pattern	Thickness
Footprints and Traces	70 μ m

Layer Number of Measurement Board	Material	Board Size	Thermal Via ^(Note 7)	
			Pitch	Diameter
4 Layers	FR-4	114.3 mm x 76.2 mm x 1.6 mmt	1.20 mm	Φ 0.30 mm

Top		2 Internal Layers		Bottom	
Copper Pattern	Thickness	Copper Pattern	Thickness	Copper Pattern	Thickness
Footprints and Traces	70 μ m	74.2 mm x 74.2 mm	35 μ m	74.2 mm x 74.2 mm	70 μ m

(Note 7) This thermal via connects with the copper pattern of all layers.

Recommended Operating Conditions

Parameters	Symbol	Min	Typ	Max	Unit
Operating Temperature	T _{opr}	-25	+25	+85	°C
Operating Supply Voltage (VCC)	V _{CC}	8.0	24.0	28.0	V
Control Input Voltage (Note 8)	V _{IN1}	0	-	V _{REG50}	V

(Note 8) FR, SS_SEL, POLE_SEL, PWM, TEST, PS, BRK pins

Electrical Characteristics (Unless otherwise specified $V_{CC}=24V$ $T_a=25^{\circ}C$)

Parameters	Symbol	Min	Typ	Max	Unit	Conditions
Circuit Current	I_{CC}	-	14.0	28.0	mA	PS=0V
Standby Current	I_{STBY}	-	0.6	1.2	mA	PS= V_{VREG50}
VREG50 Voltage	V_{VREG50}	4.5	5.0	5.5	V	$I_o=-10$ mA
VREG15 Voltage	V_{VREG15}	1.35	1.50	1.65	V	
< Step-up Circuit >						
VG Voltage	V_G	$V_{CC}+6.6$	$V_{CC}+7.5$	$V_{CC}+8.4$	V	
< Pre-driver Output >						
High side Output H Voltage	V_{OHH}	$V_G-0.2$	$V_G-0.1$	V_G	V	$I_o=-5$ mA
High side Output L Voltage	V_{OHL}	0	0.1	0.2	V	$I_o=+5$ mA
Low side Output H Voltage	V_{OLH}	8.0	9.0	10.0	V	$I_o=-5$ mA
Low side Output L Voltage	V_{OLL}	0	0.1	0.2	V	$I_o=+5$ mA
Dead Time	t_{DT}	0.2	0.3	0.4	μs	
Output PWM Frequency	f_{PWM}	36	40	44	kHz	
<Hall Input>						
Input Bias Current	I_{HALL}	-2.0	-0.1	+2.0	μA	HUP=0V, HUN=0V HVP=0V, HVN=0V HWP=0V, HWN=0V
Common mode Input Voltage Range 1	$V_{HALLCM1}$	0	-	$V_{VREG50}-1.7$	V	When hall sensor is used
Input Voltage Range 2	$V_{HALLCM2}$	0	-	V_{VREG50}	V	When hall IC is used
Minimum Input Voltage	$V_{HALLMIN}$	50	-	-	mV _{P-P}	
Hall Input Hysteresis Level +	V_{HYSP}	8	20	32	mV	
Hall Input Hysteresis Level -	V_{HYSN}	-32	-20	-8	mV	
<PS>						
Input Current	I_{PS}	-82.5	-55.0	-27.5	μA	PS=0 V
PS Input H Voltage	V_{STBY}	3.8	-	V_{VREG50}	V	Power save
PS Input L Voltage	V_{ENA}	0	-	0.4	V	Normal drive
<FR>						
Input Current	I_{FR}	25	50	75	μA	FR= V_{VREG50}
FR Input H Voltage	V_{FRH}	3.8	-	V_{VREG50}	V	Order of Electricity] U→V→W
FR Input L Voltage	V_{FRL}	0	-	0.8	V	Order of Electricity U→W→V
<BRK>						
Input Current	I_{BRK}	25	50	75	μA	BRK= V_{VREG50}
BRK Input H Voltage	V_{BRKH}	3.8	-	V_{VREG50}	V	Short break
BRK Input L Voltage	V_{BRKL}	0	-	0.8	V	Normal drive

For the electric current parameters, write positive number for the inflowing current and negative for the current outflow from the IC.

Electrical Characteristics - Continued (Unless otherwise specified $V_{CC}=24V$ $T_a=25^{\circ}C$)

Parameters	Symbol	Min	Typ	Max	Unit	Conditions
< Control Input: POLE_SEL, SS_SEL >						
Input Current	I_{IN}	-1.0	-	+1.0	μA	
<Speed Command: PWM>						
Input Current	I_{PWM}	-75	-50	-25	μA	PWM=0 V
PWM Input H Level	V_{PVMINH}	3.8	-	V_{VREG50}	V	
PWM Input L Level	V_{PVMINL}	0	-	0.8	V	
PWM Input Frequency Range	f_{PVMIN}	1	-	50	kHz	
<FGO Output>						
Output L Voltage	V_{FGOL}	0	0.1	0.3	V	$I_{FGO}=+3$ mA
Output Leak Current	I_{FGLEAK}	-	-	1	μA	FGO=30 V
<Current limit: RCL>						
RCL Outflow Current	I_{RCL}	-35	-20	-10	μA	RCL=0 V
RCL Pin Input Voltage Range	V_{RCL}	-0.3	-	+1.0	V	
Current Limit Detection Voltage	V_{CL}	0.23	0.25	0.27	V	
<UVLO>						
VCC UVLO Release Voltage	V_{UVH}	6.5	7.0	7.5	V	
VCC UVLO Lockout Voltage	V_{UVL}	5.5	6.0	6.5	V	
VCC UVLO Hysteresis Voltage	V_{UVHYS}	-	1.0	-	V	
VREG50 UVLO Release Voltage	V_{UV50H}	3.6	3.8	4.0	V	
VREG50 UVLO Lockout Voltage	V_{UV50L}	3.4	3.6	3.8	V	
VREG50 UVLO Hysteresis Voltage	$V_{UV50HYS}$	-	0.2	-	V	
VG UVLO Voltage	V_{UVVG}	$V_{CC}+2.0$	$V_{CC}+3.0$	$V_{CC}+4.0$	V	
<OVLO>						
OVLO Release Voltage	V_{OVL0}	28.5	30.0	31.5	V	
OVLO Lockout Voltage	V_{OVH0}	29.5	31.0	32.5	V	
OVLO Hysteresis Voltage	V_{OVHYS}	-	1.0	-	V	
< Lock Protection >						
Lock Protection Detection Time	t_{ON}	0.4	0.5	0.6	s	
Lock Protection Time	t_{OFF}	4.5	5	5.5	s	

For the electric current parameters, write positive number for the inflowing current and negative for the current outflow from the IC.

Application Example

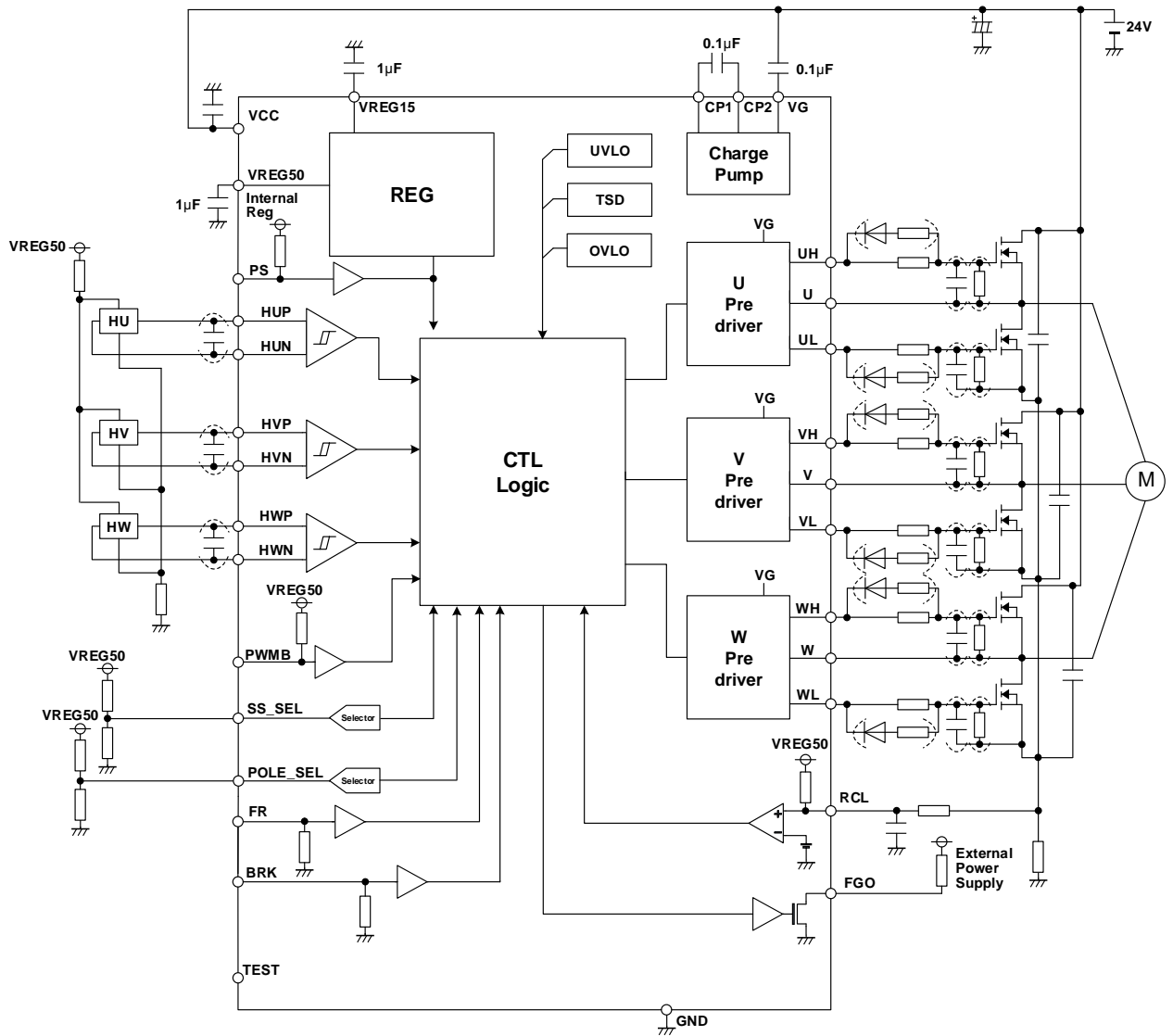

Figure 3. Application example

Board Design Note

1. IC power, IC ground, motor outputs (U, V, W), and motor ground (RNF) lines are made as wide as possible.
2. The IC ground (signal GND) is arranged as close as the ground connector of PCB.
3. The bypass capacitor (VCC, FET side) are placed as close as possible to the VCC pin and FET.

Typical Performance Curves

(Reference data)

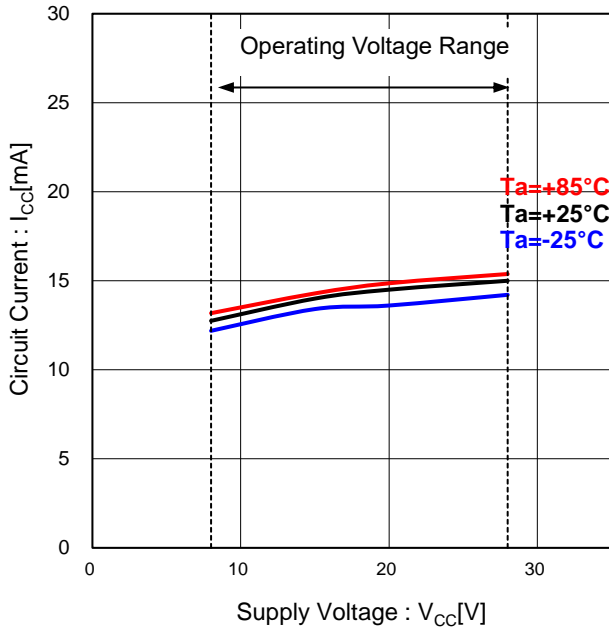

Figure 4. Circuit Current vs Supply Voltage

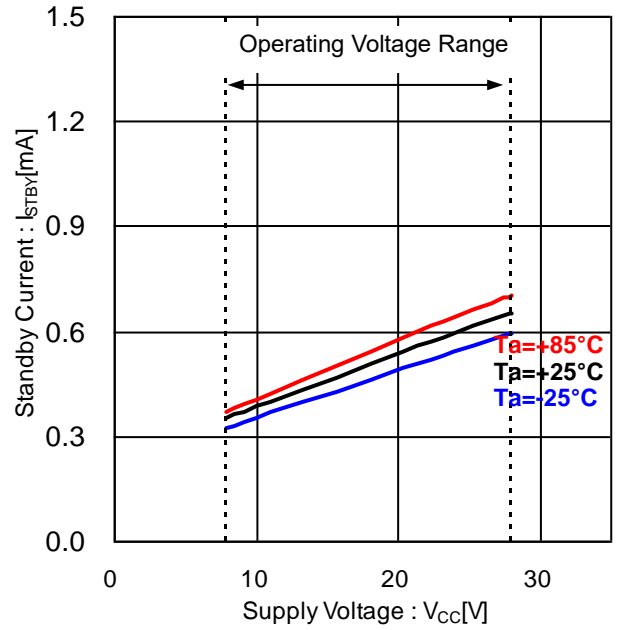

Figure 5. Standby Current vs Supply Voltage

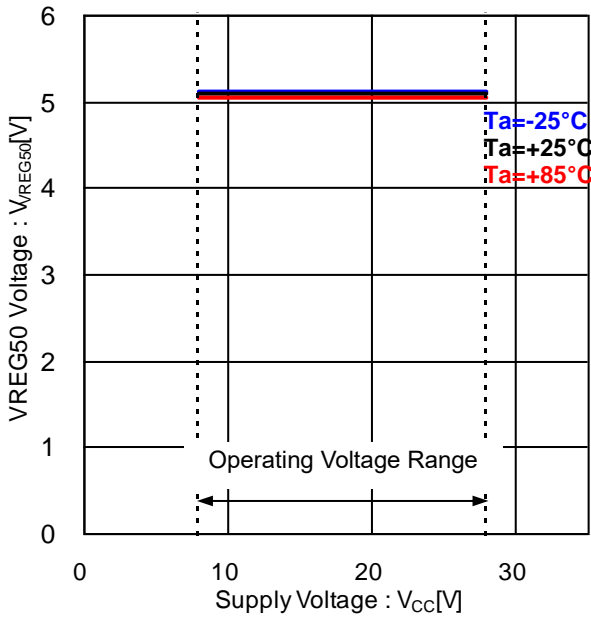

Figure 6. VREG50 Voltage vs Supply Voltage

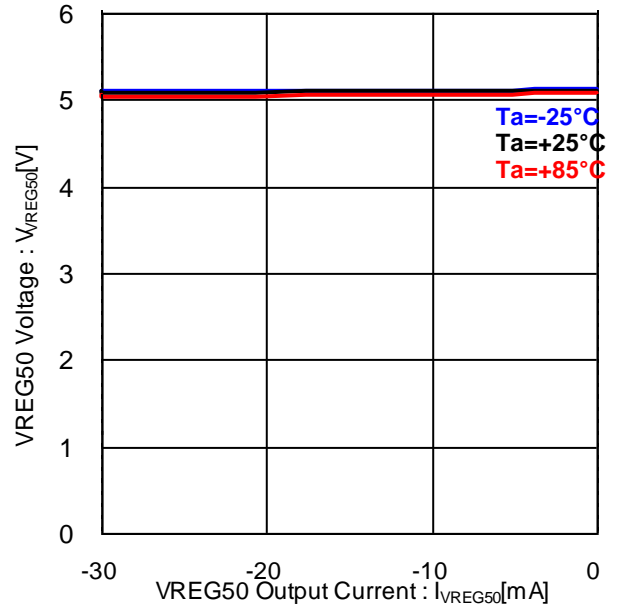

Figure 7. VREG50 Voltage vs VREG50 Output Current (V_{CC}=24V)

Typical Performance Curves - continued
(Reference data)

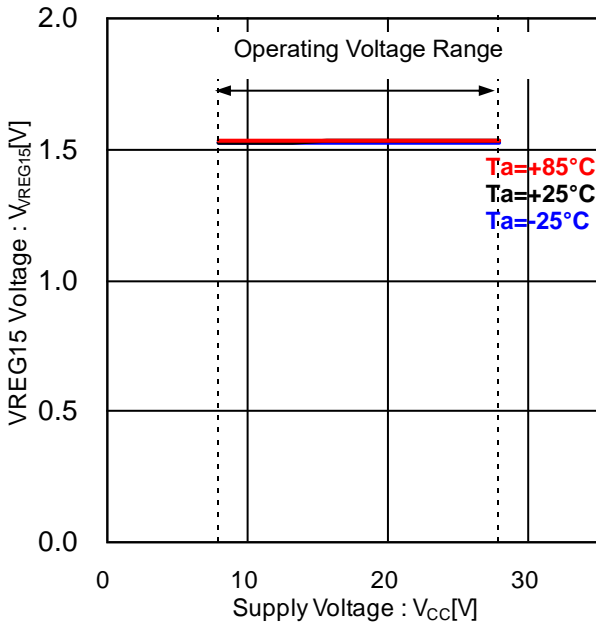

Figure 8. VREG15 Voltage vs Supply Voltage

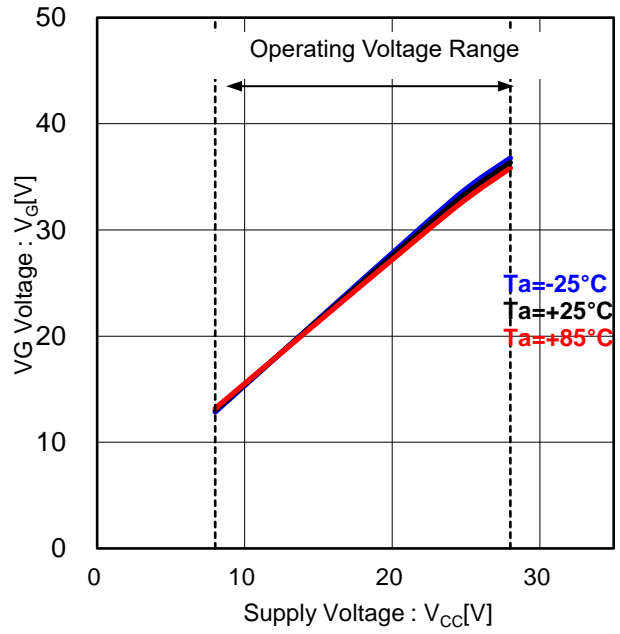

Figure 9. VG Voltage vs Supply Voltage

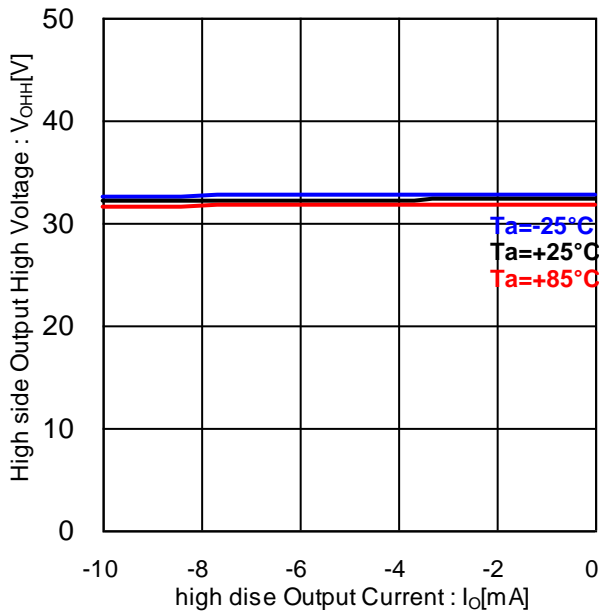

Figure 10. High side Output High Voltage vs High side Output Current (V_{CC}=24V)

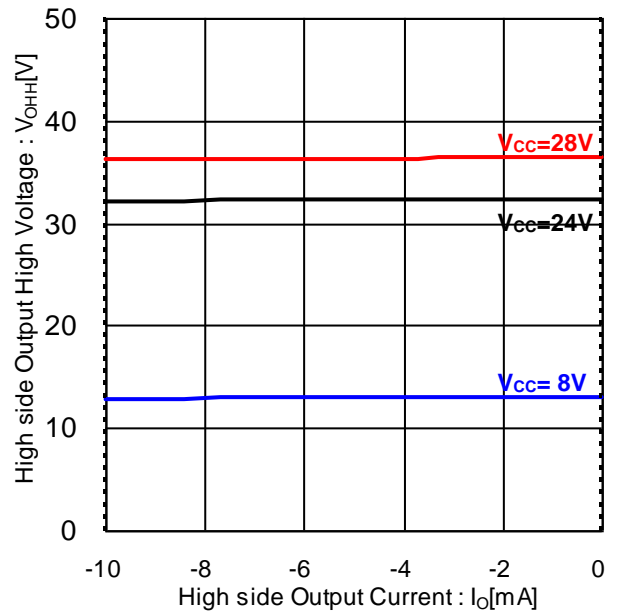

Figure 11. High side Output High Voltage vs High side Output Current (Ta=25°C)

Typical Performance Curves - continued

(Reference data)

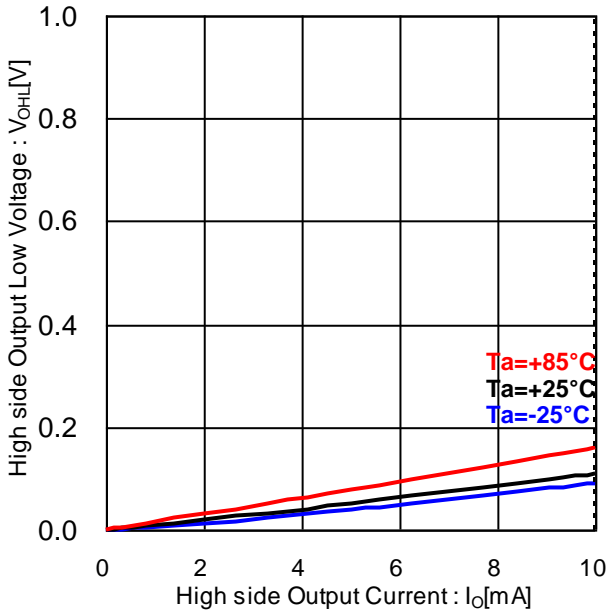

Figure 12. High side Output Low Voltage vs High side Output Current ($V_{CC}=24V$)

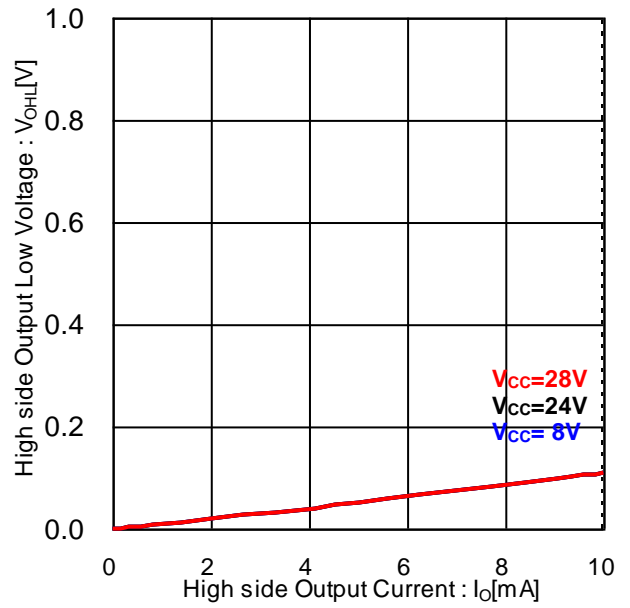

Figure 13. High side Output Low Voltage vs High side Output Current ($T_a=25^{\circ}C$)

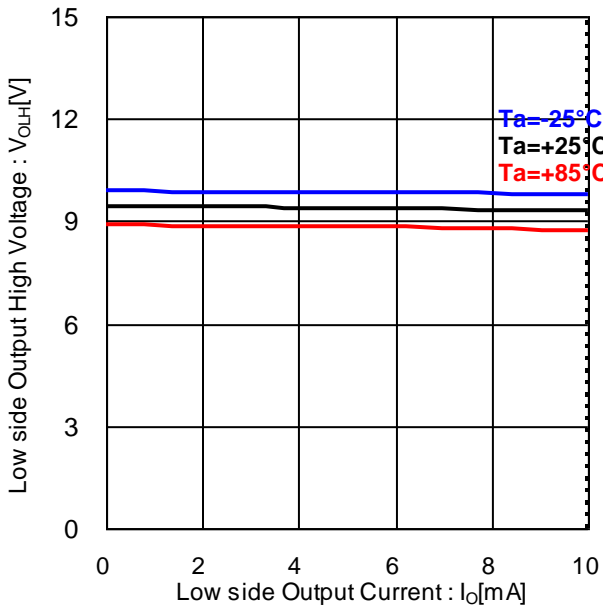

Figure 14. Low side Output High Voltage vs Low side Output Current ($V_{CC}=24V$)

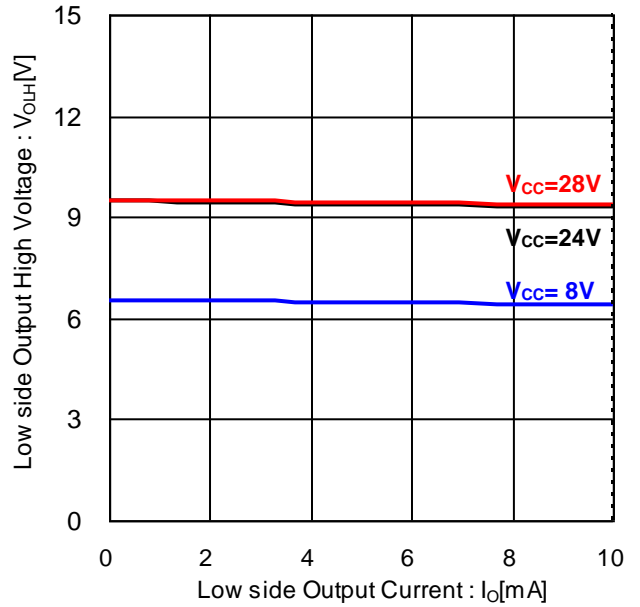

Figure 15. Low side Output High Voltage vs Low side Output Current ($T_a=25^{\circ}C$)

Typical Performance Curves - continued

(Reference data)

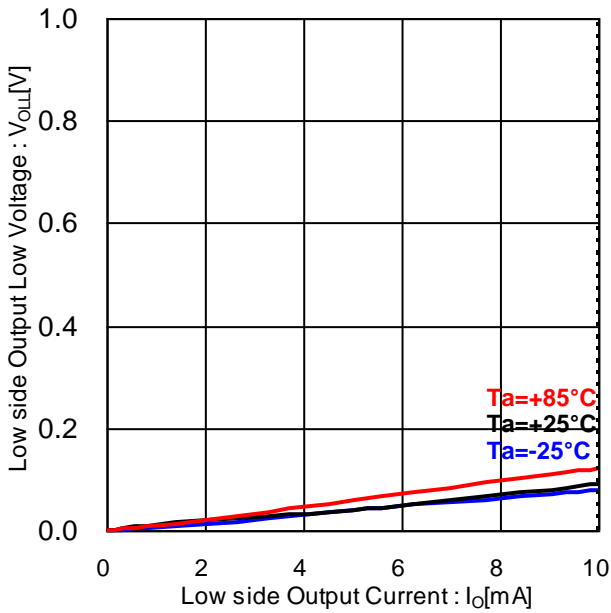

Figure 16. Low side Output Low Voltage vs Low side Output Current ($V_{CC}=24V$)

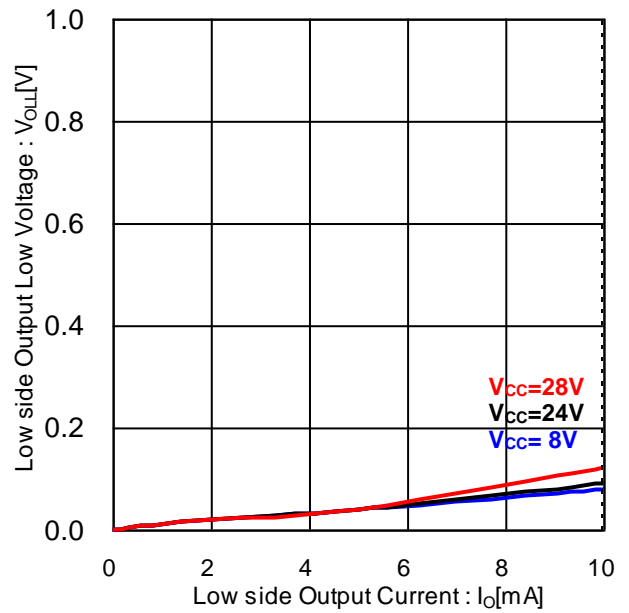

Figure 17. Low side Output Low Voltage vs Low side Output Current ($T_a=25^\circ C$)

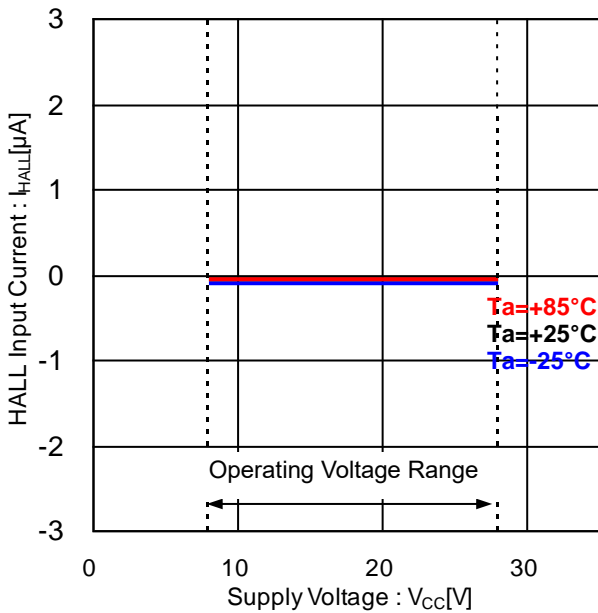

Figure 18. HALL Input Current vs Supply Voltage

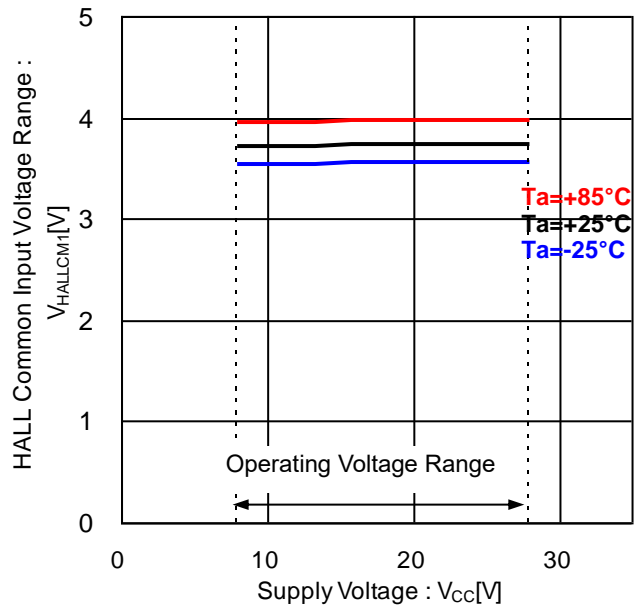

Figure 19. HALL Common Input Voltage Range vs Supply Voltage

Typical Performance Curves - continued

(Reference data)

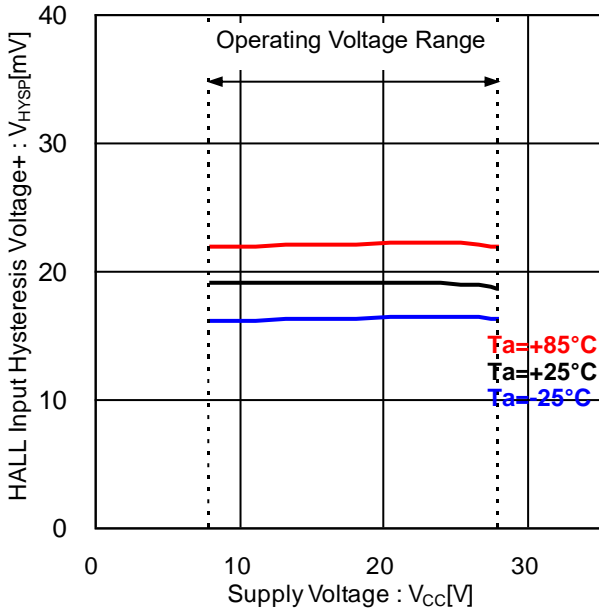

Figure 20. HALL Input Hysteresis Voltage+ vs Supply Voltage

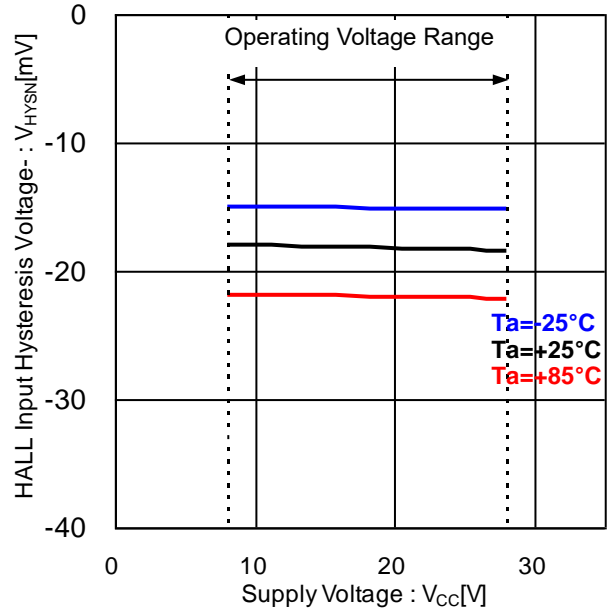

Figure 21. HALL Input Hysteresis Voltage- vs Supply Voltage

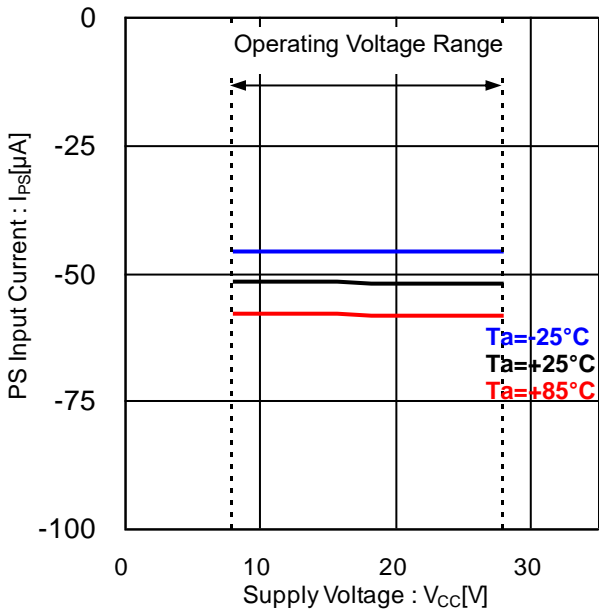

Figure 22. PS Input Current vs Supply Voltage

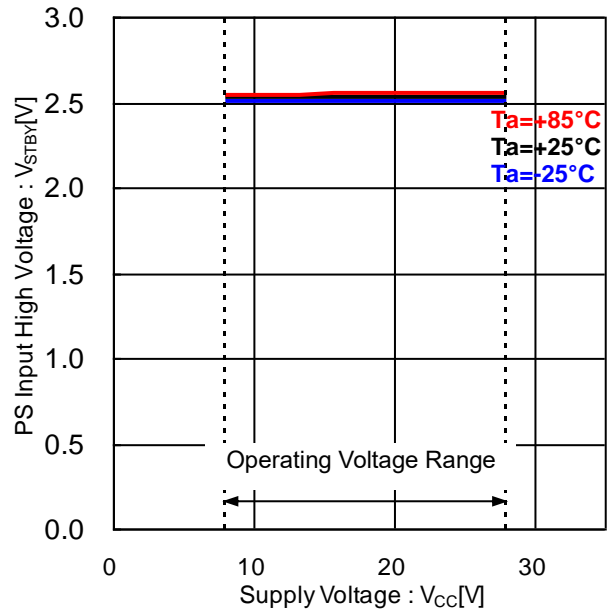

Figure 23. PS Input High Voltage vs Supply Voltage

Typical Performance Curves - continued

(Reference data)

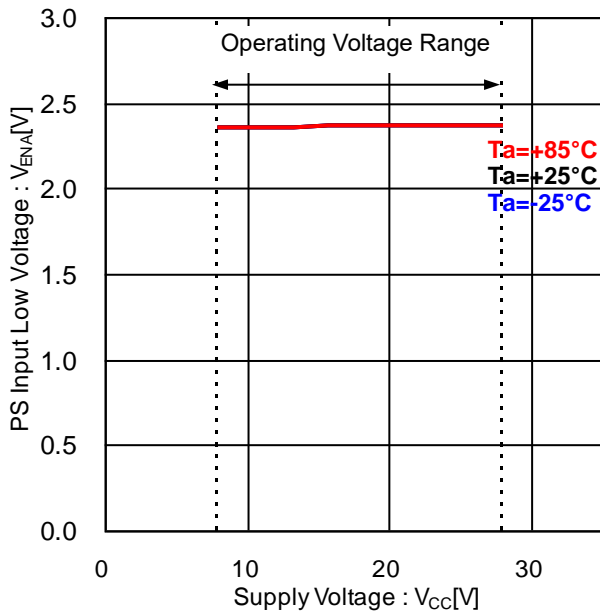

Figure 24. PS Input Low Voltage vs Supply Voltage

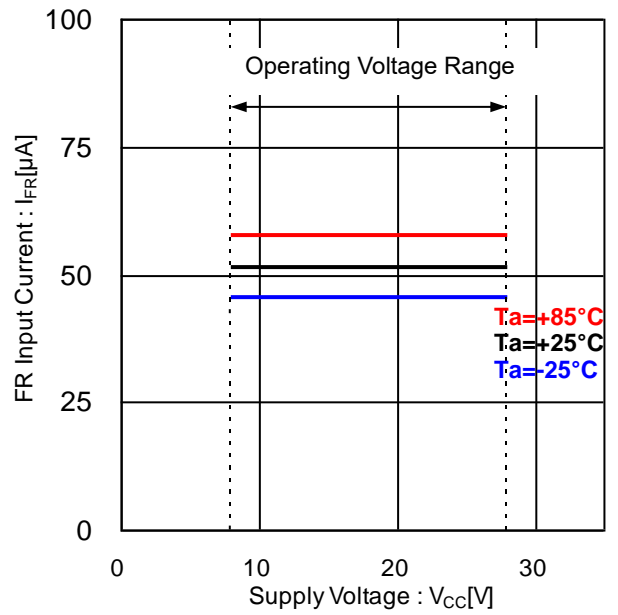

Figure 25. FR Input Current vs Supply Voltage

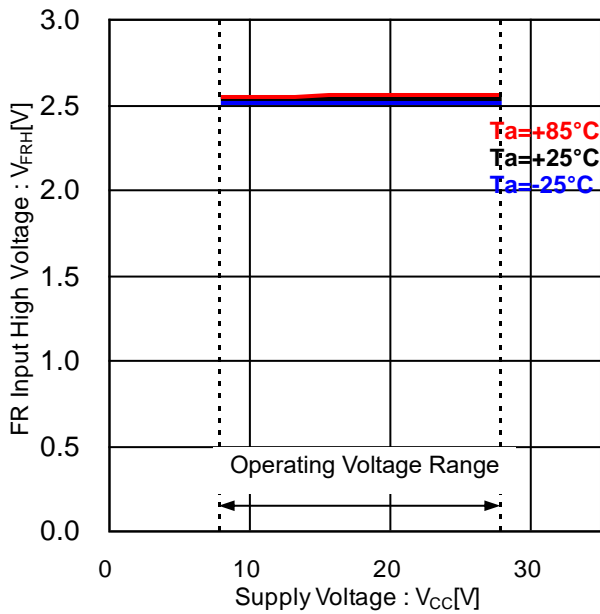

Figure 26. FR Input High Voltage vs Supply Voltage

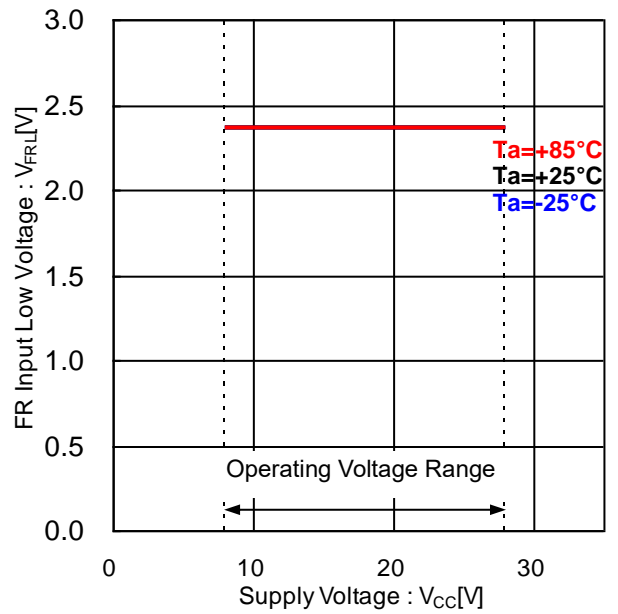

Figure 27. FR Input Low Voltage vs Supply Voltage

Typical Performance Curves - continued

(Reference data)

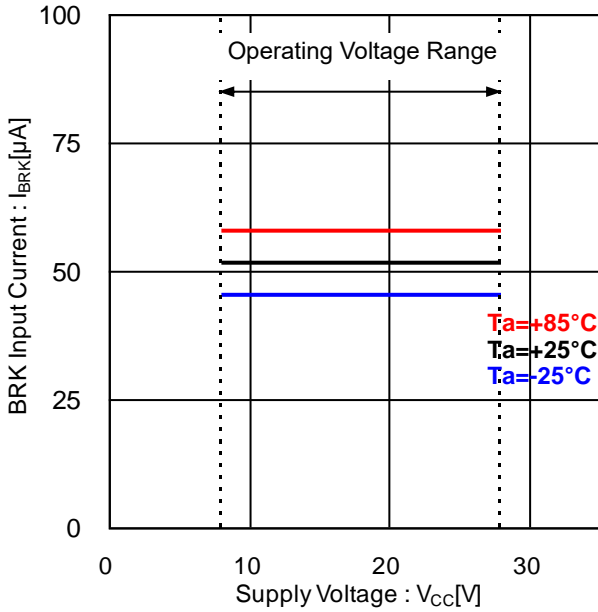

Figure 28. BRK Input Current vs Supply Voltage

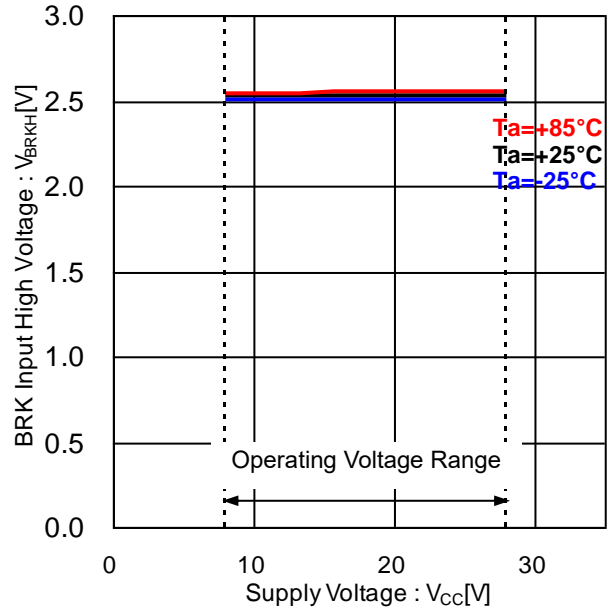

Figure 29. BRK Input High Voltage vs Supply Voltage

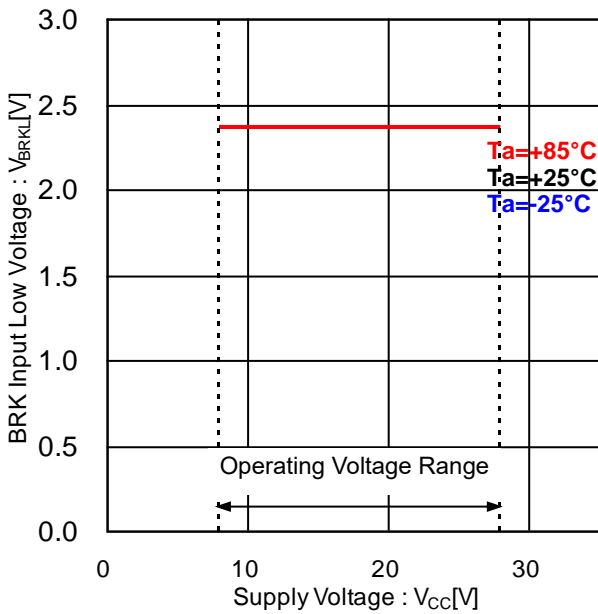

Figure 30. BRK Input Low Voltage vs Supply Voltage

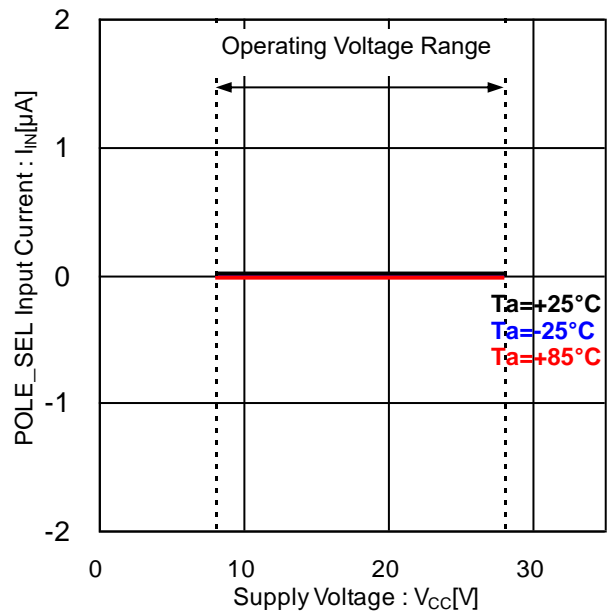

Figure 31. POLE_SEL Input Current vs Supply Voltage

Typical Performance Curves - continued

(Reference data)

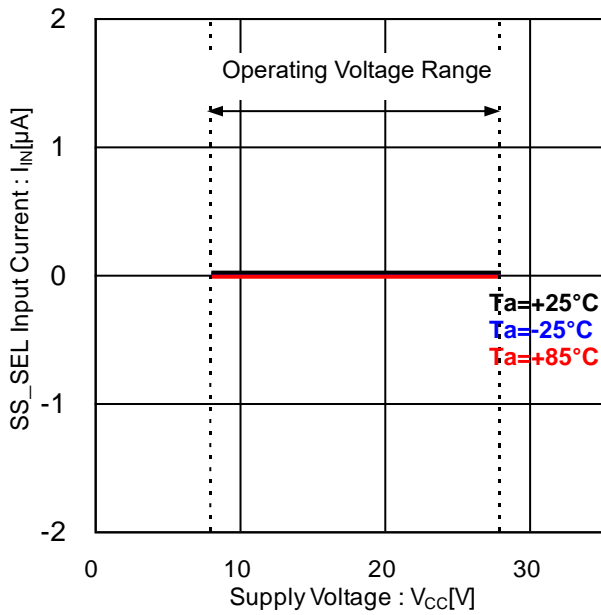

Figure 32. SS_SEL Input Current vs Supply Voltage

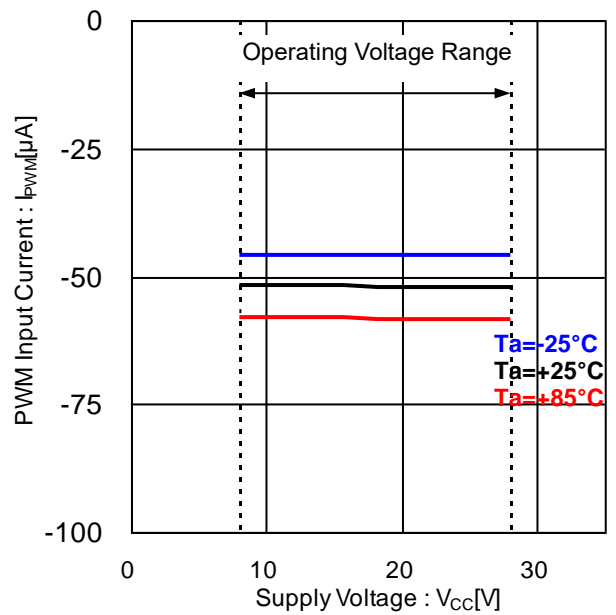

Figure 33. PWM Input Current vs Supply Voltage

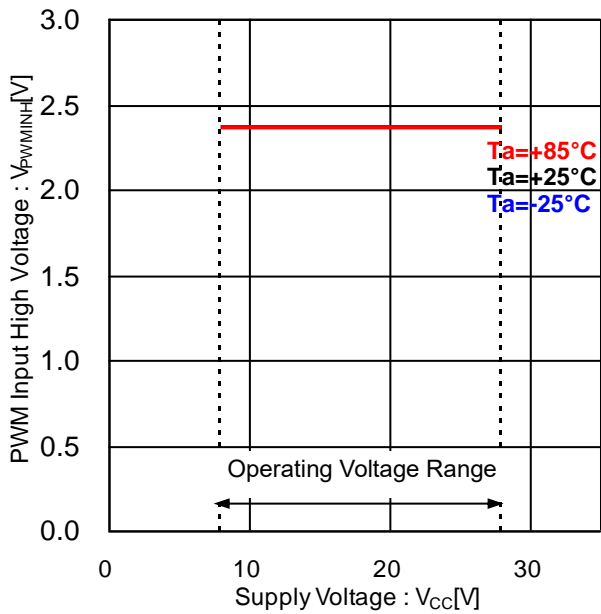

Figure 34. PWM Input High Voltage vs Supply Voltage

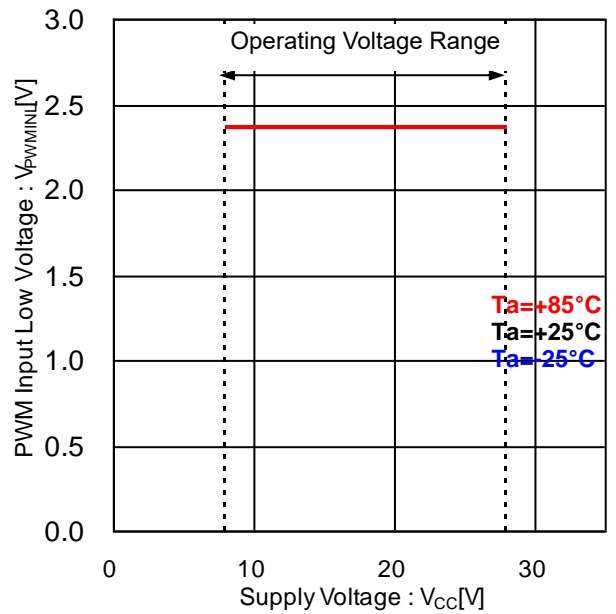

Figure 35. PWM Input Low Voltage vs Supply Voltage

Typical Performance Curves - continued

(Reference data)

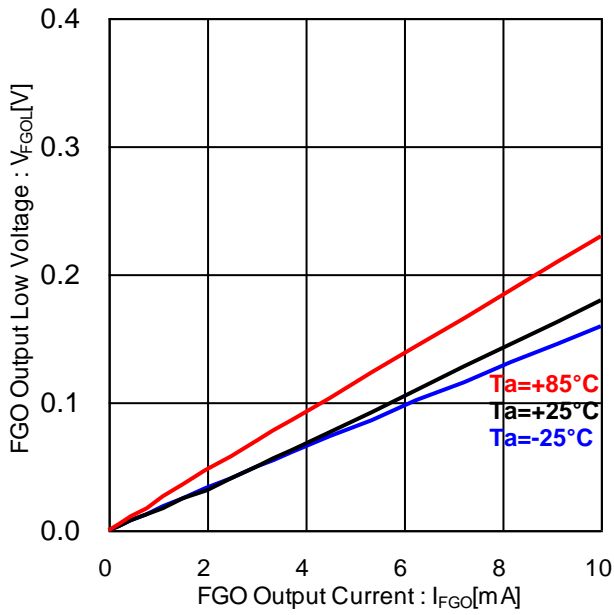

Figure 36. FGO Output Low Voltage vs FGO Output Current ($V_{CC}=24V$)

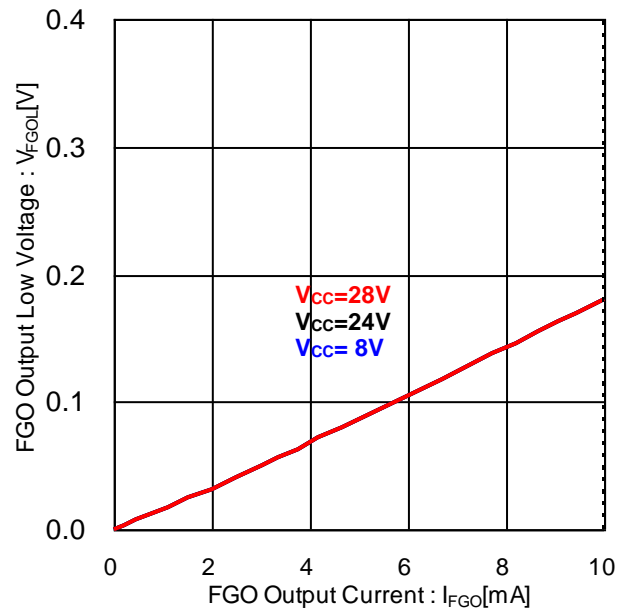

Figure 37. FGO Output Low Voltage vs FGO Output Current ($T_a=25^\circ C$)

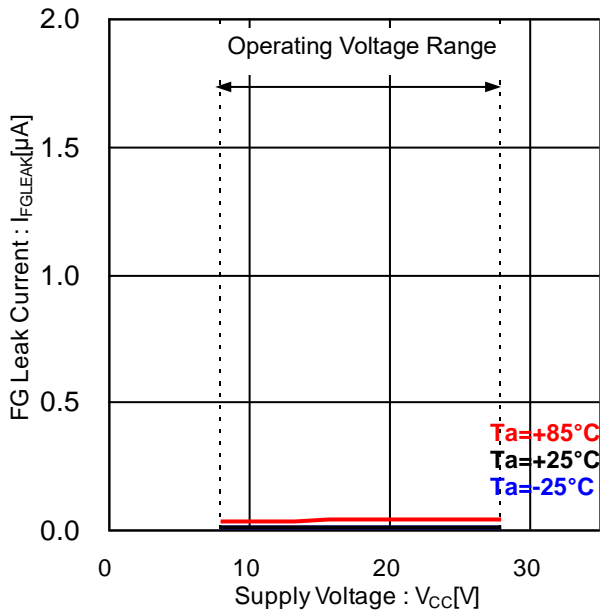

Figure 38. FG Leak Current vs Supply Voltage

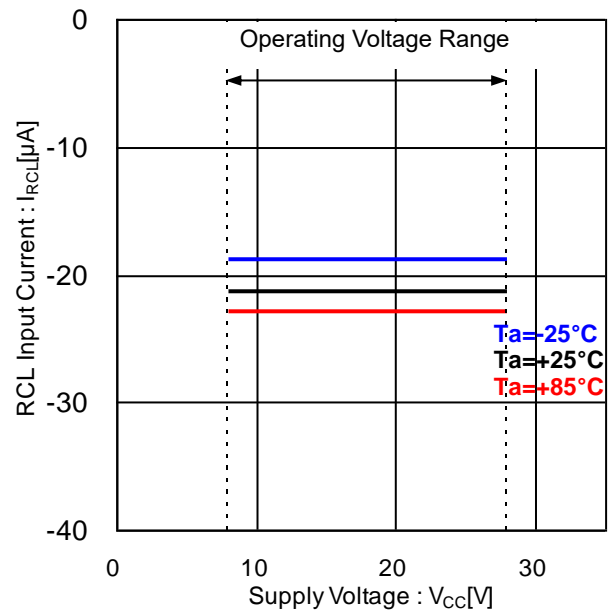

Figure 39. RCL Input Current vs Supply Voltage

Typical Performance Curves - continued
(Reference data)

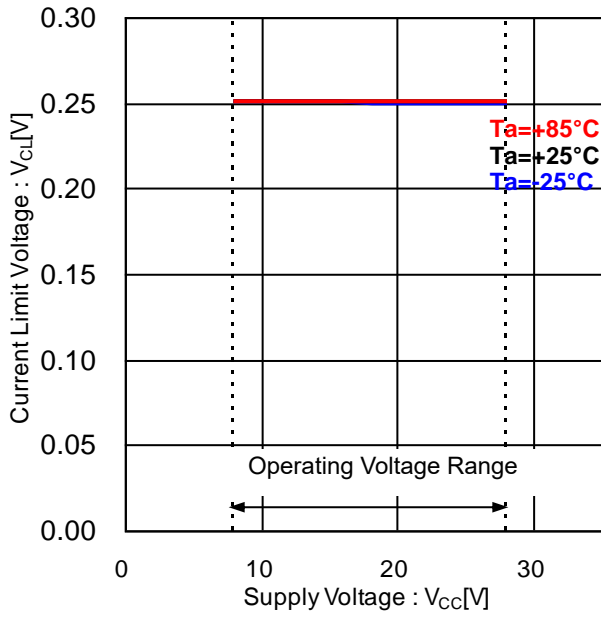

Figure 40. Current Limit Voltage vs Supply Voltage

Description of Function Operations

1. Drive

It detects the rotor position on the three hall sensors. In addition, minimized sounds and low vibration are implemented by making the output current a sin waveform.

(1) Timing chart of the sine wave drive on 3 hall sensors

The timing chart of the 3-hall sensor signal and external power transistor output signal are shown in Figure 41.

FR=High (Electricity order U → V → W, lead angle setting 0 degree)

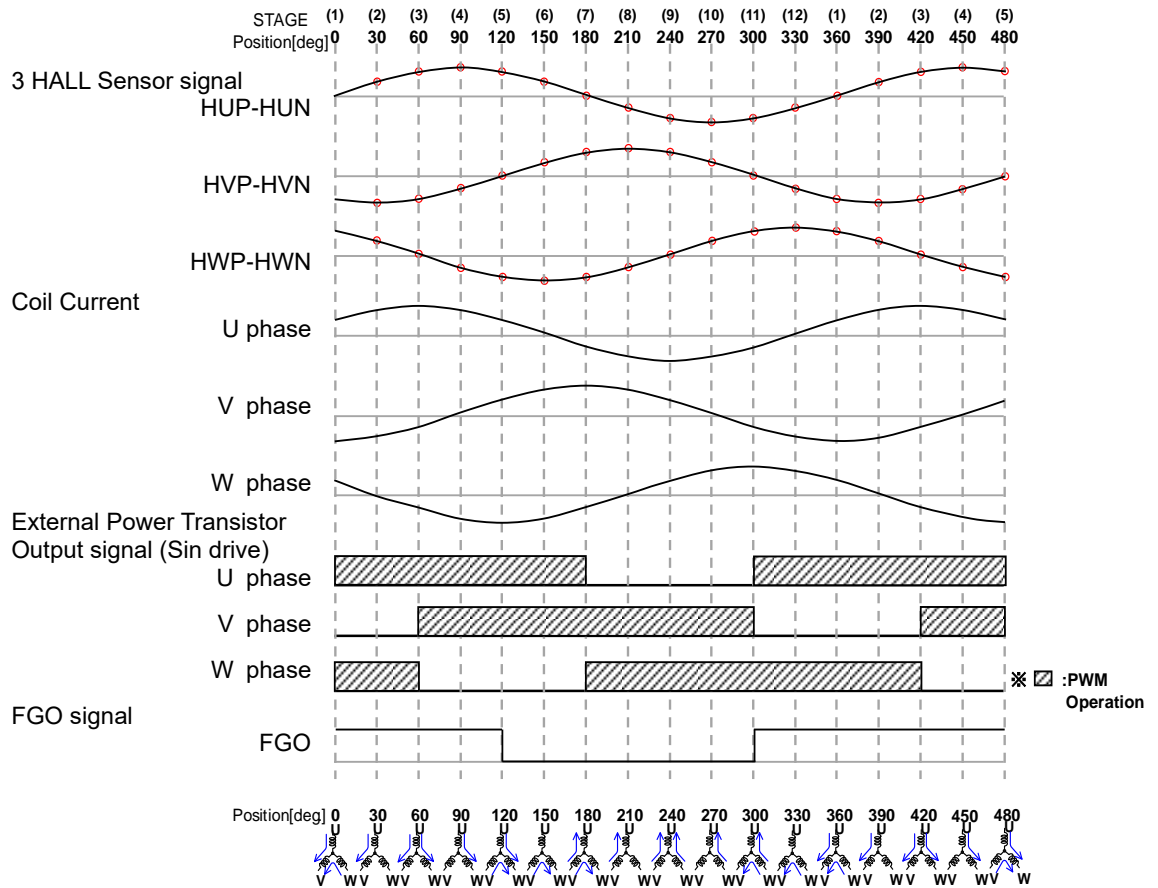

Figure 41. Timing Chart of Hall Detection Drive (FR=High)

(1) Timing chart of the sine wave drive on 3 hall sensors - continued

FR=Low (Electricity order U → W → V, lead angle setting 0 degree)

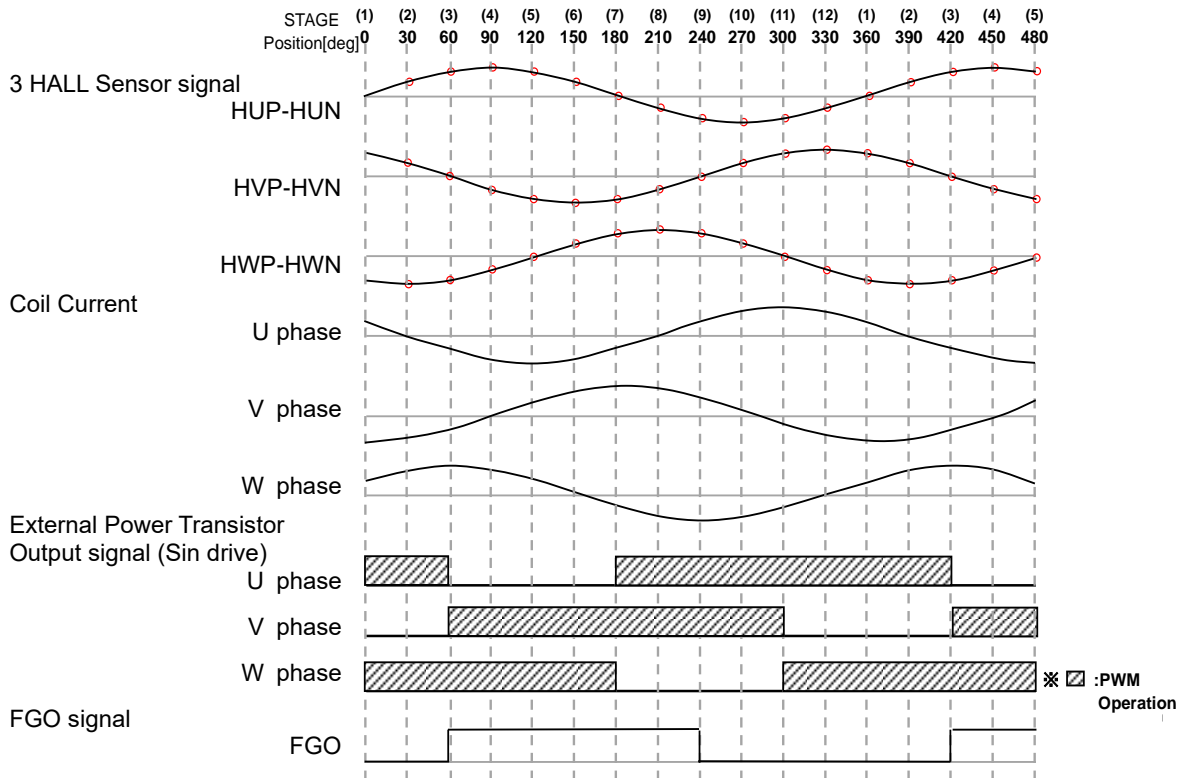

Figure 42. Timing Chart of Hall Detection Drive (FR=Low)

[Adjustment of the Hall Sensor]

When the hall sensor is used, the amplitude adjustment of the hall signal is important for a stable drive. The amplitude of hall signal larger than the hall input hysteresis level + (V_{HYS}) and hall input hysteresis level - (V_{HYS}) is necessary to detect the position of the normal motor.

1. Drive - continued

(2) Electricity Logic

FR=High (Electricity order U→V→W)

Table 1. Electricity Logic Table

STAGE	Input Condition			Output State		
	HU =(HUP)-(HUN)	HV =(HVP)-(HVN)	HW =(HWP)-(HWN)	U	V	W
1	Middle	Low	High	PWM	Low	PWM
2	High	Low	High	PWM	Low	PWM
3	High	Low	Middle	PWM	Low to PWM	PWM to Low
4	High	Low	Low	PWM	PWM	Low
5	High	Middle	Low	PWM	PWM	Low
6	High	High	Low	PWM	PWM	Low
7	Middle	High	Low	PWM to Low	PWM	Low to PWM
8	Low	High	Low	Low	PWM	PWM
9	Low	High	Middle	Low	PWM	PWM
10	Low	High	High	Low	PWM	PWM
11	Low	Middle	High	Low to PWM	PWM to Low	PWM
12	Low	Low	High	PWM	Low	PWM

2. Lock Protection Function

When the motor locks due to disturbance factors, there are protection functions (lock protection function) that turns off all aspects of external power transistor output (lock protection time t_{OFF} : typ 5.0s) for a certain period of time so that the current will not continue to flow in the coil current. In addition, it has a function that automatically restarts afterwards.

Lock Detection Judgment

When the motor normally rotates, the change of hall signal will be detected but when the motor is locked, it will not be detected. When the change of hall signal is not detected for a certain period (lock protection detect time t_{ON} : typ 500ms), it will be judged as motor lock. (It becomes 75rpm when it is converted into the rotation speed of 4pole motors, when it is less than the rotation speed mentioned, it will be judged as motor locked.) The waveform/ timing chart of the hall signal and each output aspect during motor lock is shown in Figure 43.

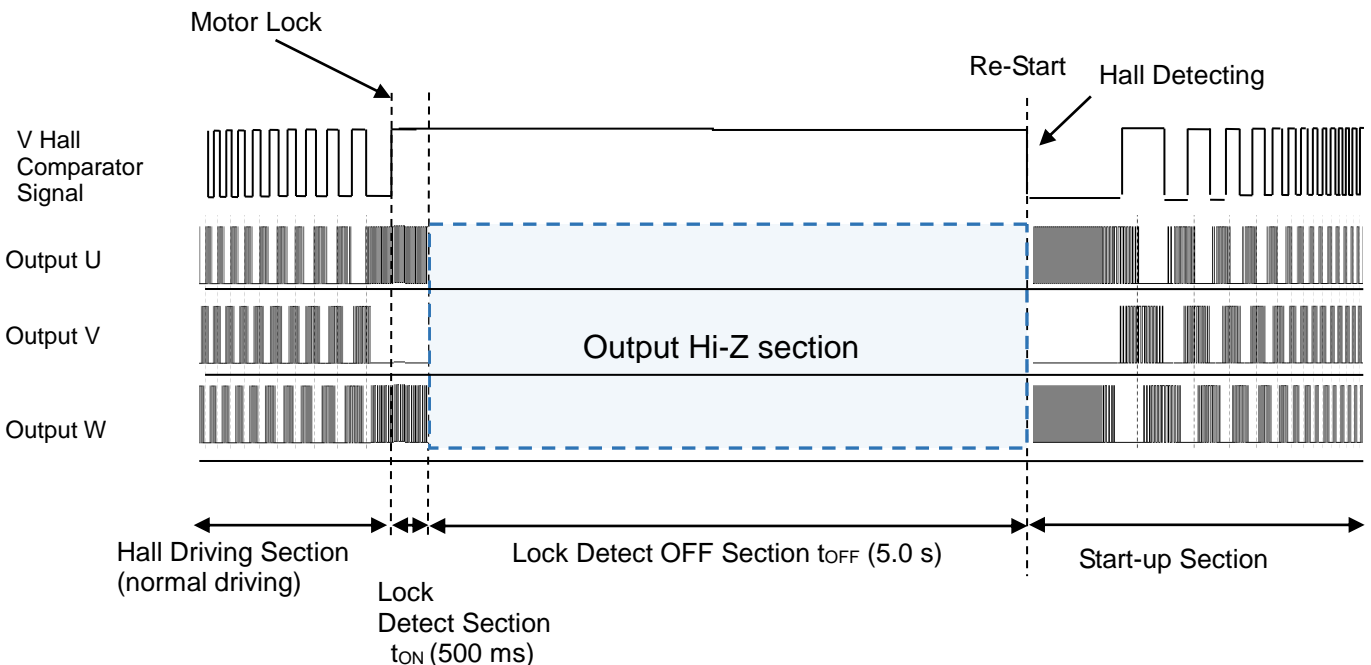

Figure 43. Timing Chart during Lock Protection

Description of Function Operations - continued

3. Current Limit Setting (RCL pin)

It detects the coil current, when it detects a current more than the current setting value, all aspects of the external power transistor output will be turned off and it will cut off the current. When the current is less than the current value setting in the timing of next PWM (ON) after turning off all aspects of the external power transistor output for drive, the output returns to normal drive.

Setting current value I_o that operates the current limit is determined on the resistance R_1 to use for the current limit setting voltage (V_{CL}) 250mV (Typ) and the coil current detection in the IC. Please refer to the formula shown below.

$$\begin{aligned}
 I_o [A] &= V_{CL} [V] / R_1 [\Omega] \\
 &= 250 [mV] / 0.2 [\Omega] \\
 &= 1.25 [A] \\
 P_c [W] &= V_{CL} [V] \times I_o [A] \\
 &= 250 [mV] \times 1.25 [A] \\
 &= 0.3125 [W]
 \end{aligned}$$

When the current limit function is not used, short the RCL pin with GND.

A large current flows in the resistor R_1 to use for the coil current detection.

Because the power consumption P_c becomes the calculation in the formula shown above, please pay attention to the power dissipation.

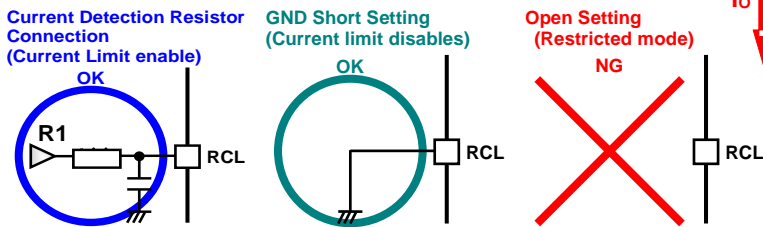

Figure 44. RCL pin process

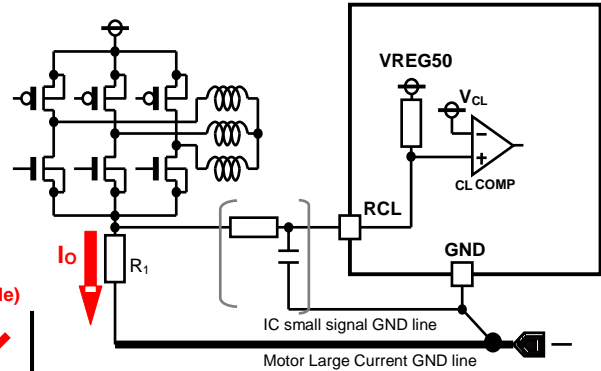

Figure 45. Small Signal and Large Current GND line separation

During PCB layout design, separate the small signal ground line of the IC with a large current ground line motor connected to R_1 as shown in Figure 45.

4. Soft Start Time Setting (SS_SEL pin)

When it starts from the motor stop state, a function (soft start function) gradually increases the coil current to control the inrush current.

The start-up command which starts from the motor stop state restarts when the motor stopped on the start of the motor at power supply injection, start on the torque input (PWM pin), start on the power save cancellation (PS pin), restart from lock protection, restart from the reverse brake mode at change of rotation direction (FR pin). It also includes each protection circuit (high-speed rotation protection, low speed rotation protection, overvoltage protection, under voltage lock-out and overheat protection).

About the current limit during soft start, it maintains the sine wave drive by gradually increasing the output duty of the external power transistor.

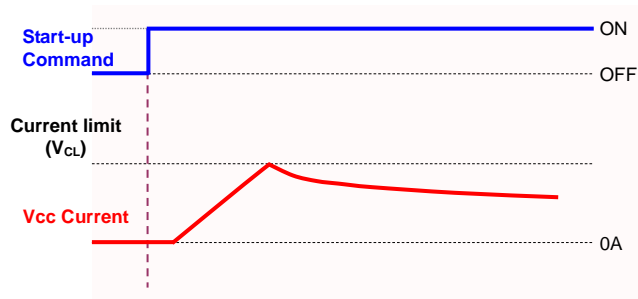

Figure 46. Timing Chart of the Coil Current Waveform at Soft Start

4. Soft Start Time Setting (SS_SEL pin) - continued

The soft start function can gradually increase the current limit setting voltage in the IC.
 The soft start time for 1 step is set on the voltage of the soft start control pin (SS_SEL) as shown in Table 2. Set it on the partial pressure resistance from VREG50 pin.
 The current limit setting voltage in the IC increases for 1step 5.16mV (Typ). Therefore, the soft start time can be calculated as follows.

Soft start time = Time for 1 step $\times (V_{CL} / 5.16mV)$
 For example, when set it in $SS_SEL = 0V$,
 It becomes, Time of 1step = $49ms / (250mV / 5.16mV) = 2.37s$

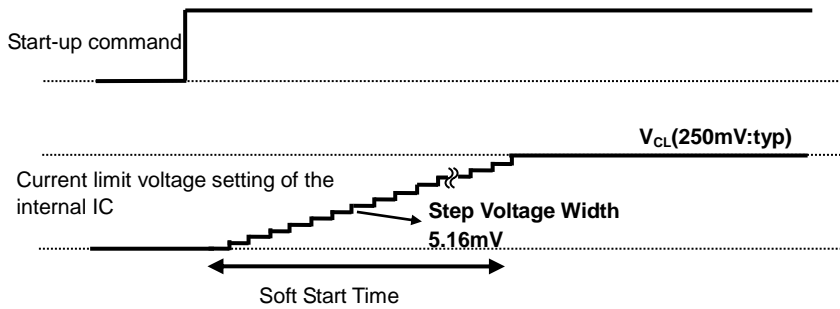

Figure 47. Timing Chart of the Current Limit Voltage Setting during Soft Start

Table 2. SS_SEL pin setting table

SS_SEL pin setting						Time for 1 step	
0.000	x	V _{VREG50}	to	0.056	x	V _{VREG50}	49 ms
0.069	x	V _{VREG50}	to	0.119	x	V _{VREG50}	98 ms
0.131	x	V _{VREG50}	to	0.181	x	V _{VREG50}	147 ms
0.194	x	V _{VREG50}	to	0.244	x	V _{VREG50}	197 ms
0.256	x	V _{VREG50}	to	0.306	x	V _{VREG50}	246 ms
0.319	x	V _{VREG50}	to	0.369	x	V _{VREG50}	295 ms
0.381	x	V _{VREG50}	to	0.431	x	V _{VREG50}	344 ms
0.444	x	V _{VREG50}	to	0.494	x	V _{VREG50}	393 ms
0.506	x	V _{VREG50}	to	0.556	x	V _{VREG50}	442 ms
0.569	x	V _{VREG50}	to	0.619	x	V _{VREG50}	491 ms
0.631	x	V _{VREG50}	to	0.681	x	V _{VREG50}	541 ms
0.694	x	V _{VREG50}	to	0.744	x	V _{VREG50}	590 ms
0.756	x	V _{VREG50}	to	0.806	x	V _{VREG50}	639 ms
0.819	x	V _{VREG50}	to	0.869	x	V _{VREG50}	688 ms
0.881	x	V _{VREG50}	to	0.931	x	V _{VREG50}	737 ms
0.944	x	V _{VREG50}	to	1.000	x	V _{VREG50}	786 ms

5. Power Save (PS pin)

The power save control is possible with PS pin. Normal drive (motor drive) state becomes PS=Low and it enters power save (motor stop) during PS=High or Open. The power save is prioritized over other control input signals and the internal power supply VREG50 output turns off. Furthermore, PS pin is pulled up on the internal REG (5V) by the 100kΩ (Typ) resistor.

Table 3. PS pin Setting Table

PS pin Setting	Function
Low	Normal Drive
High / Open	Power Save

Description of Function Operations – continued

6. Short break control (BRK pin)

The rotation stops immediately on BRK pin. All upper part pre-driver outputs (UH, VH, WH) of each aspect becomes Low in BRK=High, all lower pre-driver outputs (UL, VL, WL) of each aspect becomes High and enters short brake operation. (the external upper part power transistor of each aspect is off and the external lower power transistor is on) It cancels the short brake operation when BRK=Low or Open. In addition, the BRK pin is pulled-down by 100kΩ (Typ) resistor of the internal IC. During short brake operation, the pre-driver output enters short brake operation but continues the operation based on the hall sensor signal of the internal IC. When the short brake operation is canceled, it resumes the operating conditions in the IC at that time.

The priority of Short brake is higher than other protection functions. Therefore, when short brake works during other protection function operation, protection function is canceled and short brake operation is enable.

Table 4. BRK pin Setting Table

BRK pin Setting	Function
Low / Open	Normal Drive
High	Short Break

7. Change of Rotation Direction (FR pin)

FR pin can change the electricity order. It becomes U → V → W in FR=High and becomes U → W → V in FR=Low or Open. The change of the electricity order is not recommended during motor rotation, but shift to brake mode (reverse brake mode) once when it changed. (When number of revolutions decreases to 500 rpm@4 pole or less as for the restart) As for the FR pin, it is pulled-down by the resistor of 100 kΩ(typ) in the IC.

Table 5. FR pin Setting Table

FR pin Setting	Function
Low / Open	Electricity Order U→W→V
High	Electricity Order U→V→W

8. Motor Polarity Setting (POLE_SEL pin)

It can perform motor pole number setting with POLE_SEL pin. The FGO output frequency, high-speed rotation protection and low-speed rotation protection can be set on the voltage of the POLE_SEL pin as shown in Table 6. Please set it on the resistance partial pressure from VREG50 pin.

Table 6. POLE_SEL pin Setting Table

POLE_SEL pin setting						Number of Motor Polarity (Poles)	
0.00	x	V _{VREG50}	to	0.13	x	V _{VREG50}	4
0.16	x	V _{VREG50}	to	0.27	x	V _{VREG50}	6
0.30	x	V _{VREG50}	to	0.41	x	V _{VREG50}	8
0.59	x	V _{VREG50}	to	0.70	x	V _{VREG50}	12
0.73	x	V _{VREG50}	to	0.84	x	V _{VREG50}	16
0.87	x	V _{VREG50}	to	1.00	x	V _{VREG50}	10

9. Under Voltage Lock Out (UVLO: Under Voltage Lock Out)

In extremely low supply voltage area deviating from normal operation, it is a protection function that prevents the unexpected operations such as high current flow in drive FET by turning off all aspects of external power transistor of the IC intentionally. (Upper/lower FET drive of each U, V, W aspect). The under voltage lock out (UVLO ON) works when VCC is 6V (Typ) or less in an area less than 8V of the recommended operating supply voltage and the external power transistor turns off. There is a hysteresis and it returns to normal operation (UVLO cancellation) when the VCC is 7V (Typ) or more.

10. Over Voltage Lock Out (OVLO: Over Voltage Lock Out)

When the VCC voltage becomes 31V (Typ) or more, all upper part pre-driver outputs (UH, VH, WH) of each aspect becomes Low and all lower pre-driver outputs (UL, VL, WL) of each aspect becomes High. So, the external power transistor becomes short brake status. Therefore, this IC enters overvoltage protection (OVLO ON). (the external upper part power transistor of each aspect is off and the external lower power transistor is on) In addition, the Charge Pump function for VG voltage will turn off. There is a hysteresis, and the overvoltage protection is cancelled (OVLO cancellation) after 5s(Typ) when VCC is 30V (Typ) or less. Furthermore, mask time of 4μs(Typ) is set for the prevention of malfunction.

Description of Function Operations – continued**11. High-speed rotation protection, low-speed rotation protection**

When a rotating speed boost up is caused by uncontrollable motor, it has the protection function which turn OFF output for a certain period and automatically return afterward not to continue applying current in helix and not to fall uncontrollable motor into super slow rotation.

Table 7. No. of each rotation of speed protection function (Typ)

Speed protection function	Protection Function Judgment Condition (At 4-pole calculation)
High-speed rotation protection	40300 rpm or more
Low-speed rotation protection	100 rpm or less

Thermal Resistance Model

Heat generated by consumed power of IC is radiated from the mold resin or lead frame of package. The parameter which indicates this heat dissipation capability (hardness of heat release) is called thermal resistance. Thermal resistance from the chip junction to the ambient is represented in θ_{JA} [$^{\circ}\text{C}/\text{W}$], and thermal characterization parameter from junction to the top center of the outside surface of the component package is represented in Ψ_{JT} [$^{\circ}\text{C}/\text{W}$]. Thermal resistance is divide into the package part and the substrate part. Thermal resistance in the package part depends on the composition materials such as the mold resins and the lead frames. On the other hand, thermal resistance in the substrate part depends on the substrate heat dissipation capability of the material, the size, and the copper foil area etc. Therefore, thermal resistance can be decreased by the heat radiation measures like installing a heat sink etc. in the mounting substrate. The thermal resistance model is shown in Figure 48, and equation is shown below.

Equation

$$\theta_{JA} = \frac{Tj-Ta}{P} \text{ [}^{\circ}\text{C/W]}$$

$$\psi_{JT} = \frac{Tj-Tt}{P} \text{ [}^{\circ}\text{C/W]}$$

Where:

- θ_{JA} is the thermal resistance from junction to ambient [$^{\circ}\text{C}/\text{W}$]
- ψ_{JT} is the thermal characterization parameter from junction to the top center of the outside surface of the component package [$^{\circ}\text{C}/\text{W}$]
- Tj is the junction temperature [$^{\circ}\text{C}$]
- Ta is the ambient temperature [$^{\circ}\text{C}$]
- Tt is the package outside surface (top center) temperature [$^{\circ}\text{C}$]
- P is the power consumption [W]

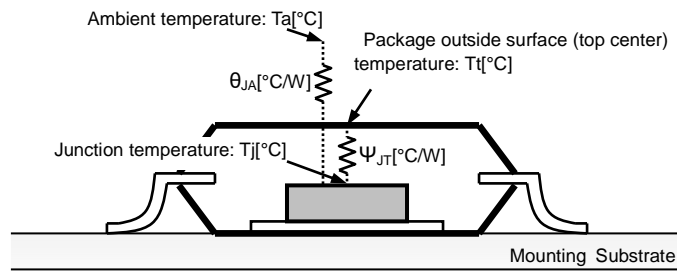
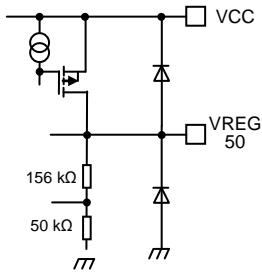

Figure 48. Thermal Resistance Model of Surface Mount

Even if it uses the same package, θ_{JA} and Ψ_{JT} are changed depending on the chip size, power consumption and the measurement environments of the ambient temperature, the mounting condition and the wind velocity, etc.

I/O Equivalence Circuits (Resistors are standard values)

1) VREG50 pin



2) VREG15 pin

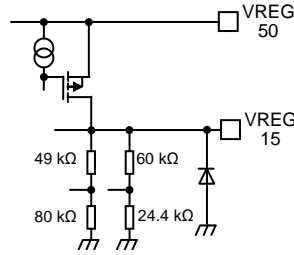

3) PS pin

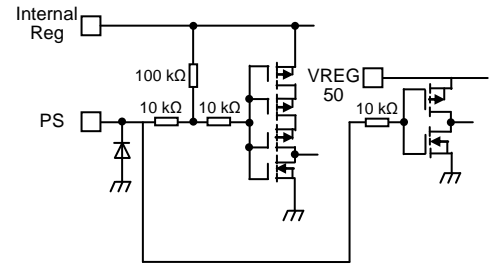

4) PWM, SS_SEL pin

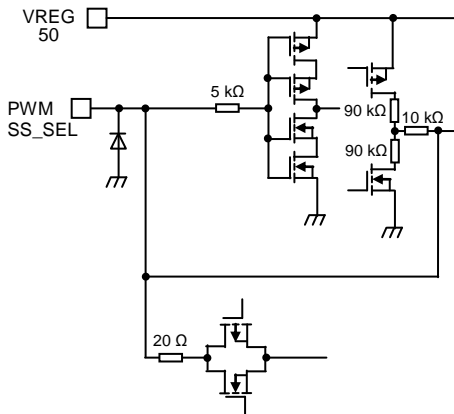

5) UH,U,VH,V,WH,W pin

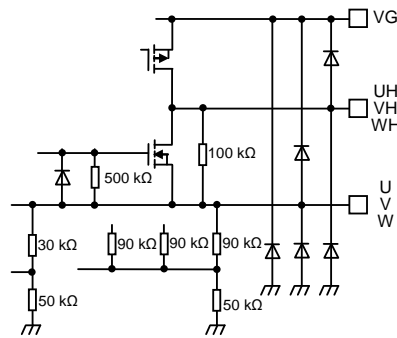

6) POLE_SEL pin

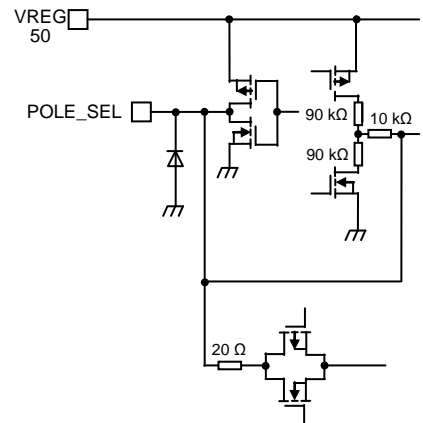

7) RCL pin

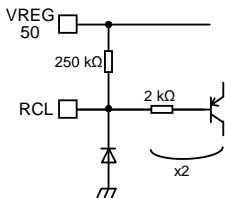

8) UL, VL, WL pin

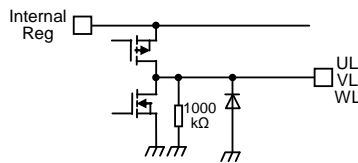

9) CP2, VG pin

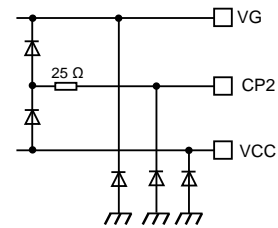

10) FGO pin

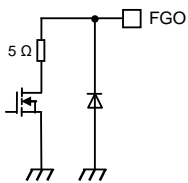

11) CP1 pin

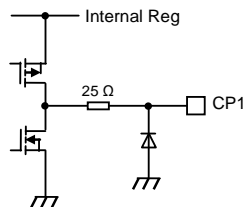

12) HUP, HUN, HVP, HVN, HWP, HWN pin

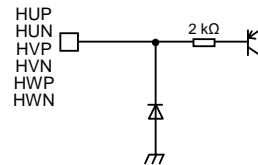

13) BRK pin

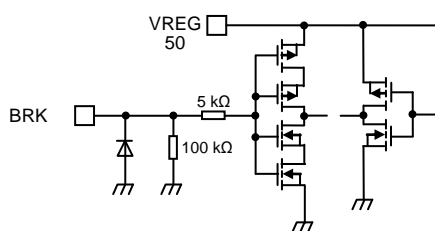

14) FR pin

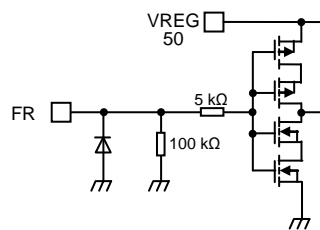

15) TEST pin

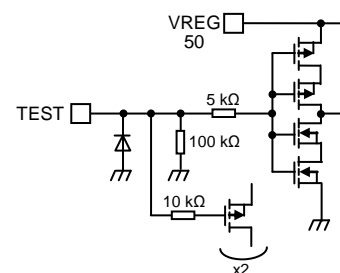

Operational Notes

1. Reverse Connection of Power Supply

Connecting the power supply in reverse polarity can damage the IC. Take precautions against reverse polarity when connecting the power supply, such as mounting an external diode between the power supply and the IC's power supply pins.

2. Power Supply Lines

Design the PCB layout pattern to provide low impedance supply lines. Furthermore, connect a capacitor to ground at all power supply pins. Consider the effect of temperature and aging on the capacitance value when using electrolytic capacitors.

3. Ground Voltage

Ensure that no pins are at a voltage below that of the ground pin at any time, even during transient condition. However, pins that drive inductive loads (e.g. motor driver outputs, DC-DC converter outputs) may inevitably go below ground due to back EMF or electromotive force. In such cases, the user should make sure that such voltages going below ground will not cause the IC and the system to malfunction by examining carefully all relevant factors and conditions such as motor characteristics, supply voltage, operating frequency and PCB wiring to name a few.

4. Ground Wiring Pattern

When using both small-signal and large-current ground traces, the two ground traces should be routed separately but connected to a single ground at the reference point of the application board to avoid fluctuations in the small-signal ground caused by large currents. Also ensure that the ground traces of external components do not cause variations on the ground voltage. The ground lines must be as short and thick as possible to reduce line impedance.

5. Recommended Operating Conditions

The function and operation of the IC are guaranteed within the range specified by the recommended operating conditions. The characteristic values are guaranteed only under the conditions of each item specified by the electrical characteristics.

6. Inrush Current

When power is first supplied to the IC, it is possible that the internal logic may be unstable and inrush current may flow instantaneously due to the internal powering sequence and delays, especially if the IC has more than one power supply. Therefore, give special consideration to power coupling capacitance, power wiring, width of ground wiring, and routing of connections.

7. Testing on Application Boards

When testing the IC on an application board, connecting a capacitor directly to a low-impedance output pin may subject the IC to stress. Always discharge capacitors completely after each process or step. The IC's power supply should always be turned off completely before connecting or removing it from the test setup during the inspection process. To prevent damage from static discharge, ground the IC during assembly and use similar precautions during transport and storage.

8. Inter-pin Short and Mounting Errors

Ensure that the direction and position are correct when mounting the IC on the PCB. Incorrect mounting may result in damaging the IC. Avoid nearby pins being shorted to each other especially to ground, power supply and output pin. Inter-pin shorts could be due to many reasons such as metal particles, water droplets (in very humid environment) and unintentional solder bridge deposited in between pins during assembly to name a few.

9. Unused Input Pins

Input pins of an IC are often connected to the gate of a MOS transistor. The gate has extremely high impedance and extremely low capacitance. If left unconnected, the electric field from the outside can easily charge it. The small charge acquired in this way is enough to produce a significant effect on the conduction through the transistor and cause unexpected operation of the IC. So unless otherwise specified, unused input pins should be connected to the power supply or ground line.

Operational Notes – continued

10. Regarding the Input Pin of the IC

This IC contains P+ isolation and P substrate layers between adjacent elements in order to keep them isolated. P-N junctions are formed at the intersection of the P layers with the N layers of other elements, creating a parasitic diode or transistor. For example (refer to figure below):

When GND > Pin A and GND > Pin B, the P-N junction operates as a parasitic diode.
 When GND > Pin B, the P-N junction operates as a parasitic transistor.

Parasitic diodes inevitably occur in the structure of the IC. The operation of parasitic diodes can result in mutual interference among circuits, operational faults, or physical damage. Therefore, conditions that cause these diodes to operate, such as applying a voltage lower than the GND voltage to an input pin (and thus to the P substrate) should be avoided.

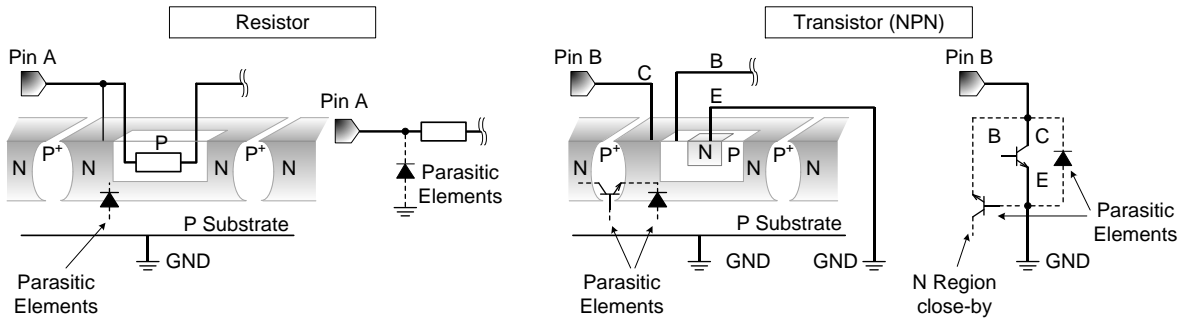

Figure 49. Example of IC Structure

11. Ceramic Capacitor

When using a ceramic capacitor, determine a capacitance value considering the change of capacitance with temperature and the decrease in nominal capacitance due to DC bias and others.

12. Thermal Shutdown Circuit (TSD)

This IC has a built-in thermal shutdown circuit that prevents heat damage to the IC. Normal operation should always be within the IC's maximum junction temperature rating. If however the rating is exceeded for a continued period, the junction temperature (Tj) will rise which will activate the TSD circuit that will turn OFF power output pins. When the Tj falls below the TSD threshold, the circuits are automatically restored to normal operation.

Note that the TSD circuit operates in a situation that exceeds the absolute maximum ratings and therefore, under no circumstances, should the TSD circuit be used in a set design or for any purpose other than protecting the IC from heat damage.

13. Over Current Protection Circuit (OCP)

This IC incorporates an integrated overcurrent protection circuit that is activated when the load is shorted. This protection circuit is effective in preventing damage due to sudden and unexpected incidents. However, the IC should not be used in applications characterized by continuous operation or transitioning of the protection circuit.

Ordering Information

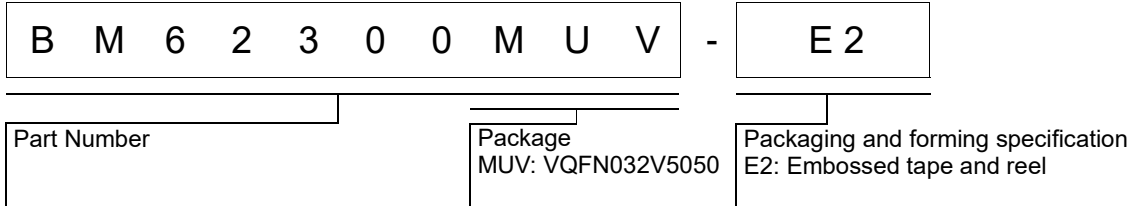

Marking Diagram

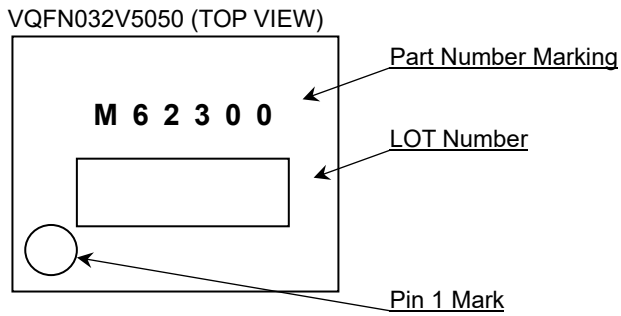

Physical Dimension and Packing Information

Package Name	VQFN032V5050
--------------	--------------

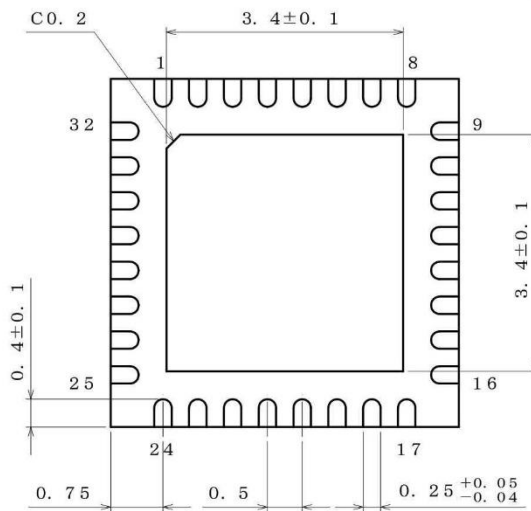
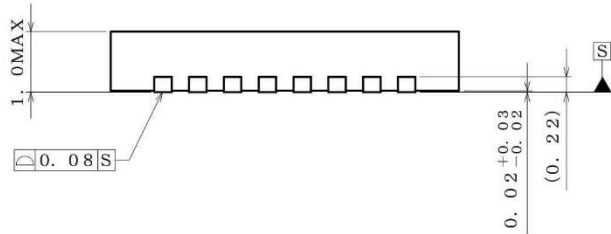
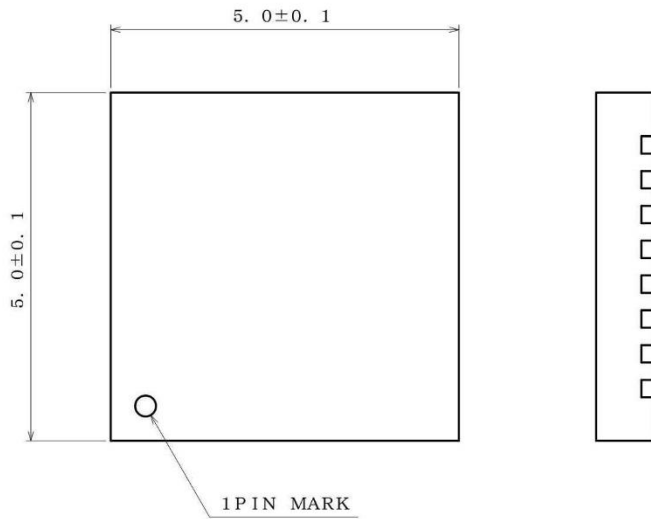

(UNIT : mm)
 PKG : VQFN032V5050
 Drawing No. EX461-5001-2

<Tape and Reel information>

Tape	Embossed carrier tape
Quantity	2500pcs
Direction of feed	E2 (The direction is the 1pin of product is at the upper left when you hold reel on the left hand and you pull out the tape on the right hand)

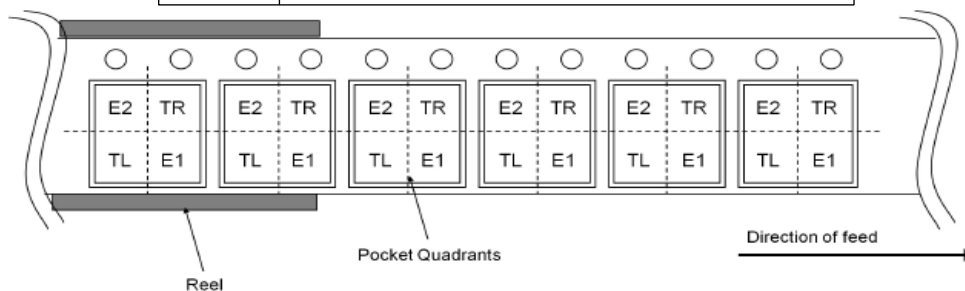

Revision History

Date	Revision	Changes
21.Sep.2018	001	New Release
30.Jun.2021	002	P3 : 5pin, 6pin are changed P1, P4, P8 : Figure is changed P25 : Table6 is changed

Notice

Precaution on using ROHM Products

- Our Products are designed and manufactured for application in ordinary electronic equipment (such as AV equipment, OA equipment, telecommunication equipment, home electronic appliances, amusement equipment, etc.). If you intend to use our Products in devices requiring extremely high reliability (such as medical equipment ^(Note 1), transport equipment, traffic equipment, aircraft/spacecraft, nuclear power controllers, fuel controllers, car equipment including car accessories, safety devices, etc.) and whose malfunction or failure may cause loss of human life, bodily injury or serious damage to property ("Specific Applications"), please consult with the ROHM sales representative in advance. Unless otherwise agreed in writing by ROHM in advance, ROHM shall not be in any way responsible or liable for any damages, expenses or losses incurred by you or third parties arising from the use of any ROHM's Products for Specific Applications.

(Note1) Medical Equipment Classification of the Specific Applications

JAPAN	USA	EU	CHINA
CLASS III	CLASS III	CLASS II b	CLASS III
CLASS IV		CLASS III	

- ROHM designs and manufactures its Products subject to strict quality control system. However, semiconductor products can fail or malfunction at a certain rate. Please be sure to implement, at your own responsibilities, adequate safety measures including but not limited to fail-safe design against the physical injury, damage to any property, which a failure or malfunction of our Products may cause. The following are examples of safety measures:
 - Installation of protection circuits or other protective devices to improve system safety
 - Installation of redundant circuits to reduce the impact of single or multiple circuit failure
- Our Products are designed and manufactured for use under standard conditions and not under any special or extraordinary environments or conditions, as exemplified below. Accordingly, ROHM shall not be in any way responsible or liable for any damages, expenses or losses arising from the use of any ROHM's Products under any special or extraordinary environments or conditions. If you intend to use our Products under any special or extraordinary environments or conditions (as exemplified below), your independent verification and confirmation of product performance, reliability, etc. prior to use, must be necessary:
 - Use of our Products in any types of liquid, including water, oils, chemicals, and organic solvents
 - Use of our Products outdoors or in places where the Products are exposed to direct sunlight or dust
 - Use of our Products in places where the Products are exposed to sea wind or corrosive gases, including Cl₂, H₂S, NH₃, SO₂, and NO₂
 - Use of our Products in places where the Products are exposed to static electricity or electromagnetic waves
 - Use of our Products in proximity to heat-producing components, plastic cords, or other flammable items
 - Sealing or coating our Products with resin or other coating materials
 - Use of our Products without cleaning residue of flux (Exclude cases where no-clean type fluxes is used. However, recommend sufficiently about the residue.) ; or Washing our Products by using water or water-soluble cleaning agents for cleaning residue after soldering
 - Use of the Products in places subject to dew condensation
- The Products are not subject to radiation-proof design.
- Please verify and confirm characteristics of the final or mounted products in using the Products.
- In particular, if a transient load (a large amount of load applied in a short period of time, such as pulse, is applied, confirmation of performance characteristics after on-board mounting is strongly recommended. Avoid applying power exceeding normal rated power; exceeding the power rating under steady-state loading condition may negatively affect product performance and reliability.
- De-rate Power Dissipation depending on ambient temperature. When used in sealed area, confirm that it is the use in the range that does not exceed the maximum junction temperature.
- Confirm that operation temperature is within the specified range described in the product specification.
- ROHM shall not be in any way responsible or liable for failure induced under deviant condition from what is defined in this document.

Precaution for Mounting / Circuit board design

- When a highly active halogenous (chlorine, bromine, etc.) flux is used, the residue of flux may negatively affect product performance and reliability.
- In principle, the reflow soldering method must be used on a surface-mount products, the flow soldering method must be used on a through hole mount products. If the flow soldering method is preferred on a surface-mount products, please consult with the ROHM representative in advance.

For details, please refer to ROHM Mounting specification

Precautions Regarding Application Examples and External Circuits

1. If change is made to the constant of an external circuit, please allow a sufficient margin considering variations of the characteristics of the Products and external components, including transient characteristics, as well as static characteristics.
2. You agree that application notes, reference designs, and associated data and information contained in this document are presented only as guidance for Products use. Therefore, in case you use such information, you are solely responsible for it and you must exercise your own independent verification and judgment in the use of such information contained in this document. ROHM shall not be in any way responsible or liable for any damages, expenses or losses incurred by you or third parties arising from the use of such information.

Precaution for Electrostatic

This Product is electrostatic sensitive product, which may be damaged due to electrostatic discharge. Please take proper caution in your manufacturing process and storage so that voltage exceeding the Products maximum rating will not be applied to Products. Please take special care under dry condition (e.g. Grounding of human body / equipment / solder iron, isolation from charged objects, setting of Ionizer, friction prevention and temperature / humidity control).

Precaution for Storage / Transportation

1. Product performance and soldered connections may deteriorate if the Products are stored in the places where:
 - [a] the Products are exposed to sea winds or corrosive gases, including Cl₂, H₂S, NH₃, SO₂, and NO₂
 - [b] the temperature or humidity exceeds those recommended by ROHM
 - [c] the Products are exposed to direct sunshine or condensation
 - [d] the Products are exposed to high Electrostatic
2. Even under ROHM recommended storage condition, solderability of products out of recommended storage time period may be degraded. It is strongly recommended to confirm solderability before using Products of which storage time is exceeding the recommended storage time period.
3. Store / transport cartons in the correct direction, which is indicated on a carton with a symbol. Otherwise bent leads may occur due to excessive stress applied when dropping of a carton.
4. Use Products within the specified time after opening a humidity barrier bag. Baking is required before using Products of which storage time is exceeding the recommended storage time period.

Precaution for Product Label

A two-dimensional barcode printed on ROHM Products label is for ROHM's internal use only.

Precaution for Disposition

When disposing Products please dispose them properly using an authorized industry waste company.

Precaution for Foreign Exchange and Foreign Trade act

Since concerned goods might be fallen under listed items of export control prescribed by Foreign exchange and Foreign trade act, please consult with ROHM in case of export.

Precaution Regarding Intellectual Property Rights

1. All information and data including but not limited to application example contained in this document is for reference only. ROHM does not warrant that foregoing information or data will not infringe any intellectual property rights or any other rights of any third party regarding such information or data.
2. ROHM shall not have any obligations where the claims, actions or demands arising from the combination of the Products with other articles such as components, circuits, systems or external equipment (including software).
3. No license, expressly or implied, is granted hereby under any intellectual property rights or other rights of ROHM or any third parties with respect to the Products or the information contained in this document. Provided, however, that ROHM will not assert its intellectual property rights or other rights against you or your customers to the extent necessary to manufacture or sell products containing the Products, subject to the terms and conditions herein.

Other Precaution

1. This document may not be reprinted or reproduced, in whole or in part, without prior written consent of ROHM.
2. The Products may not be disassembled, converted, modified, reproduced or otherwise changed without prior written consent of ROHM.
3. In no event shall you use in any way whatsoever the Products and the related technical information contained in the Products or this document for any military purposes, including but not limited to, the development of mass-destruction weapons.
4. The proper names of companies or products described in this document are trademarks or registered trademarks of ROHM, its affiliated companies or third parties.

General Precaution

1. Before you use our Products, you are requested to carefully read this document and fully understand its contents. ROHM shall not be in any way responsible or liable for failure, malfunction or accident arising from the use of any ROHM's Products against warning, caution or note contained in this document.
2. All information contained in this document is current as of the issuing date and subject to change without any prior notice. Before purchasing or using ROHM's Products, please confirm the latest information with a ROHM sales representative.
3. The information contained in this document is provided on an "as is" basis and ROHM does not warrant that all information contained in this document is accurate and/or error-free. ROHM shall not be in any way responsible or liable for any damages, expenses or losses incurred by you or third parties resulting from inaccuracy or errors of or concerning such information.