

National Semiconductor is now part of  
Texas Instruments.

Search <http://www.ti.com/> for the latest technical  
information and details on our current products and services.

# LM4570

## Single-Ended Input Motor Driver

### General Description

The LM4570 is a single supply motor driver for improved sensory experience in mobile phones and other handheld devices. The LM4570 is capable of driving up to 192mA while operating from a 3V supply. Near rail-to-rail output swing under load ensures sufficient voltage drive for most DC motors, while the differential output drive allows the voltage polarity across the motor to be reversed quickly. Reversing the voltage gives the LM4570 the ability to drive a motor both clockwise and counter clockwise from a single supply.

The LM4570 features fast turn on time, and a wide input voltage range for precise speed control. A low power shutdown mode minimizes power consumption.

Thermal and output short circuit protection prevents the device from being damaged during fault conditions.

### Key Specifications

■ High Output Current @ $V_{DD} = 3V$	192mA
■ Fast Turn On Time @ 3V	2.4ms
■ Quiescent Power Supply Current @ 3V	1.9mA
■ Shutdown Current	0.1µA (typ)

### Features

- Output Short Circuit Protection
- High Output Current Capability
- Wide Output Voltage Range
- Fast Turn on Time
- Output Short Circuit Protection
- Low Power Shutdown Mode
- Minimum external components
- Available in space-saving LLP package

### Applications

- Mobile Phones
- PDAs
- Video Game Systems

### Typical Application

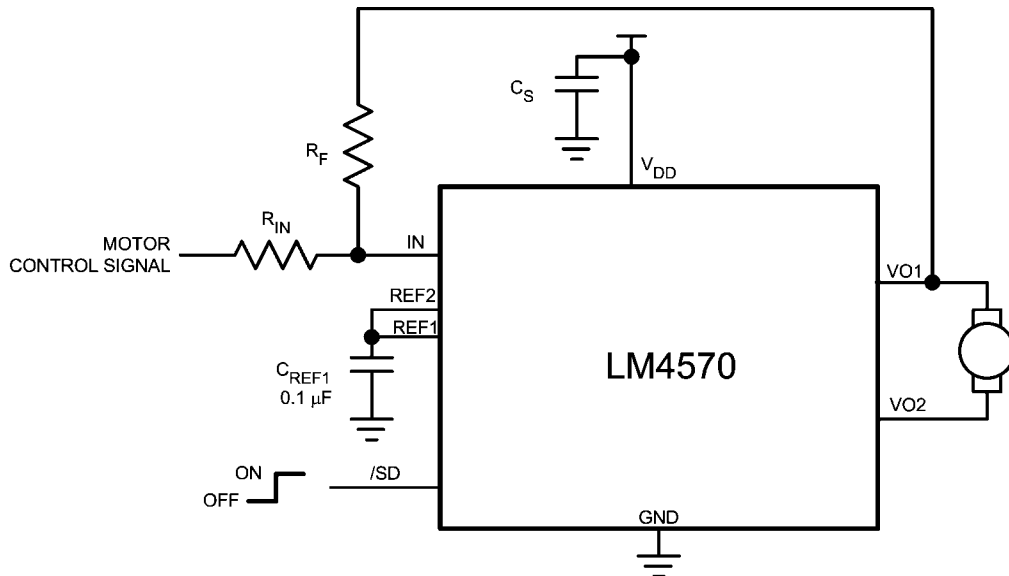

20186326

FIGURE 1. Typical Motor Driver Application Circuit

## Connection Diagrams

Leadless Leadframe Package (LLP)  
LQ Package

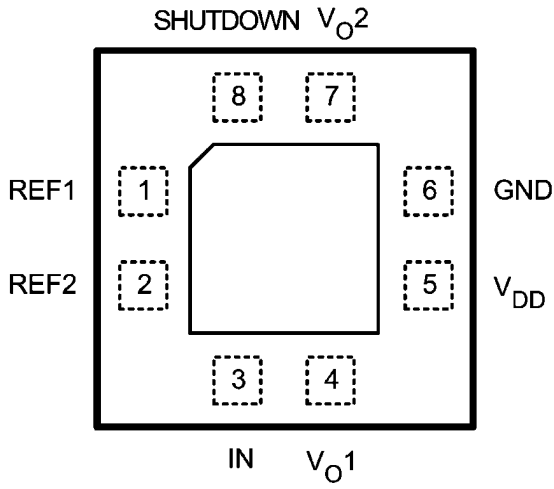

Top View  
Order Number LM4570LQ  
See NS Package Number LQB08A

20186325

LLP Marking

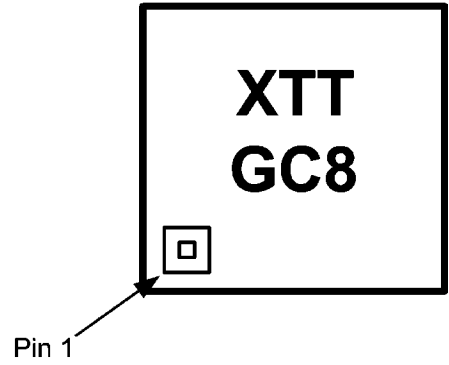

Top View  
X - One digit date code  
TT - Lot traceability  
G - Boomer Family  
C8 - LM4570LQ

20186327

## Ordering Information

Order Number	Package	Package DWG #	Transport Media	MSL Level	Green Status
LM4570LQ	8-Pin LLP	LQB08A	1000 units on tape and reel	1	RoHS & no Sb/Br
LM4570LQX	8-Pin LLP	LQB08A	4500 units on tape and reel	1	RoHS & no Sb/Br

**Absolute Maximum Ratings** (Note 2)

If Military/Aerospace specified devices are required, please contact the National Semiconductor Sales Office/Distributors for availability and specifications.

Supply Voltage (Note 1)	6.0V
Storage Temperature	-65°C to +150°C
Voltage at Any Input Pin	-0.3V $\geq$ to $V_{DD}$ +0.3V
Power Dissipation (Note 3)	Internally Limited
ESD Susceptibility (Note 4)	2000V
ESD Susceptibility (Note 5)	200V

Junction Temperature ( $T_{JMAX}$ )	150°C
Thermal Resistance	
$\theta_{JA}$ (LLP)	140°C/W

**Operating Ratings**

Temperature Range	
$T_{MIN} \leq T_A \leq T_{MAX}$	-40°C $\leq$ $T_A$ $\leq$ 85°C
Supply Voltage	2.4V $\leq$ $V_{DD}$ $\leq$ 5.5V

**Electrical Characteristics  $V_{DD} = 5V$**  (Notes 1, 2)

The following specifications apply for  $V_{DD} = 5V$ ,  $A_{V-BTL} = 6dB$  unless otherwise specified. Limits apply for  $T_A = 25^\circ C$ .

Symbol	Parameter	Conditions	LM4570		Units (Limits)
			Typical	Limit	
			(Note 6)	(Notes 7, 8)	
$I_{DD}$	Quiescent Power Supply Current	$V_{IN} = 0V, I_L = 0A$ , No Load	2.5	5.5	mA (max)
		$V_{IN} = 0V, I_L = 0A, R_L = 30\Omega$	2.6	5.5	mA (max)
$I_{SD}$	Shutdown Current	$V_{SD} = GND$	0.1	1.5	$\mu A$ (max)
$V_{IH}$	Logic Input High			1.4	V (min)
$V_{IL}$	Logic Input Low			0.4	V (max)
$V_{OS}$	Output Offset Voltage		5	$\pm 35$	mV (max)
$I_{OUT}$	Output Current	$V_{OH}, V_{OL} \leq 250mV$	268		mA
$T_{WU}$	Wake-up time		2.5		ms (max)
$V_{OH}$	Output High Voltage	$R_L = 30\Omega$ specified as $ V_{DD} - V_{OH} $	146	200	mV (max)
$V_{OL}$	Output Low Voltage	$R_L = 30\Omega$ specified as $ IGND + V_{OH} $	106	200	mV (max)

**Electrical Characteristics  $V_{DD} = 3V$**  (Notes 1, 2)

The following specifications apply for  $V_{DD} = 3V$ ,  $A_{V-BTL} = 6dB$  unless otherwise specified. Limits apply for  $T_A = 25^\circ C$ .

Symbol	Parameter	Conditions	LM4570		Units (Limits)
			Typical	Limit	
			(Note 6)	(Notes 7, 8)	
$I_{DD}$	Quiescent Power Supply Current	$V_{IN} = 0V, I_L = 0A$ , No Load	1.9	4	mA (max)
		$V_{IN} = 0V, I_L = 0A, R_L = 30\Omega$	1.95	4	
$I_{SD}$	Shutdown Current	$V_{SD} = GND$	0.1	1.0	$\mu A$ (max)
$V_{IH}$	Logic Input High			1.4	V (min)
$V_{IL}$	Logic Input Low			0.4	V (max)
$V_{OS}$	Output Offset Voltage		5	$\pm 35$	mV (max)
$I_{OUT}$	Output Current	$V_{OH}, V_{OL} \leq 200mV$	192		mA
$T_{WU}$	Wake-up time		2.4		ms (max)
$V_{OH}$	Output High Voltage	$R_L = 30\Omega$ specified as $ V_{DD} - V_{OH} $	90	110	mV (max)
$V_{OL}$	Output Low Voltage	$R_L = 30\Omega$ specified as $ V_{DD} - V_{OH} $	63	110	mV (max)

**Note 1:** All voltages are measured with respect to the ground pin, unless otherwise specified.

**Note 2:** *Absolute Maximum Ratings* indicate limits beyond which damage to the device may occur. *Operating Ratings* indicate conditions for which the device is functional, but do not guarantee specific performance limits. *Electrical Characteristics* state DC and AC electrical specifications under particular test conditions which guarantee specific performance limits. This assumes that the device is within the Operating Ratings. Specifications are not guaranteed for parameters where no limit is given; however, the typical value is a good indication of device performance.

**Note 3:** The maximum power dissipation must be de-rated at elevated temperatures and is dictated by  $T_{JMAX}$ ,  $\theta_{JC}$ , and the ambient temperature  $T_A$ . The maximum allowable power dissipation is  $P_{DMAX} = (T_{JMAX} - T_A) / \theta_{JA}$  or the number given in the Absolute Maximum Ratings, whichever is lower. For the LM4570,  $T_{JMAX} = 150^\circ\text{C}$  and the typical  $\theta_{JA}$  for the LLP package is  $140^\circ\text{C/W}$ .

**Note 4:** Human body model, 100pF discharged through a 1.5k $\Omega$  resistor.

**Note 5:** Machine Model, 220pF–240pF discharged through all pins.

**Note 6:** Typical values are measured at 25°C and represent the parametric norm.

**Note 7:** Limits are guaranteed to National's AOQL (Average Outgoing Quality Level).

**Note 8:** Datasheet min/max specification limits are guaranteed by design, test, or statistical analysis.

**Note 9:** Shutdown current is measured in a normal room environment. Exposure to direct sunlight will increase  $I_{SD}$  by a maximum of 2 $\mu\text{A}$ .

## Typical Performance Characteristics

**Output Low Voltage vs Load Current**  
 $V_{DD} = 3V$

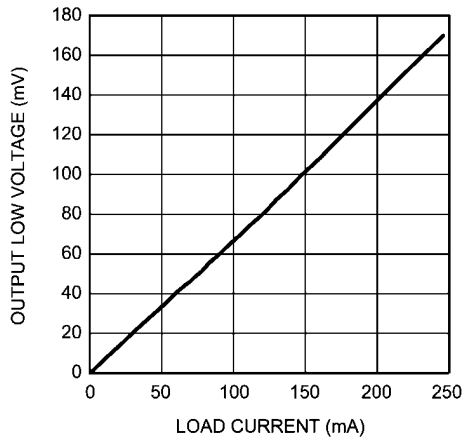

20186313

**Output Low Voltage vs Load Current**  
 $V_{DD} = 5V$

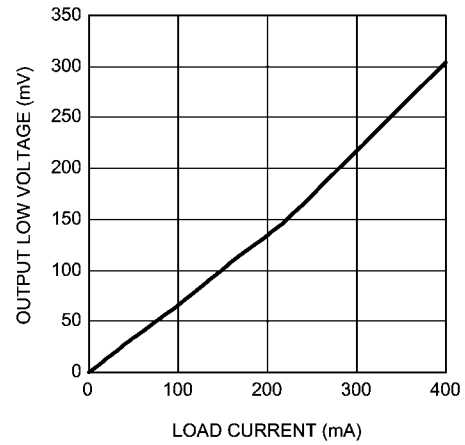

20186312

**Output High Voltage vs Load Current**  
 $V_{DD} = 3V$

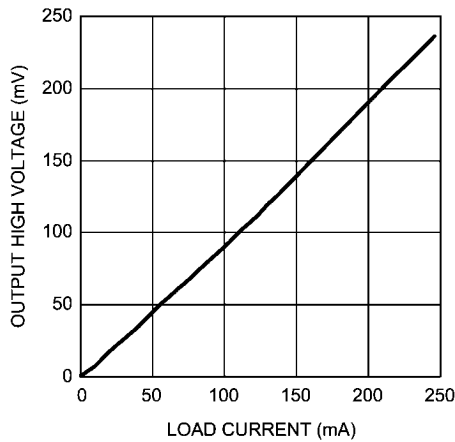

20186311

**Output High Voltage vs Load Current**  
 $V_{DD} = 5V$

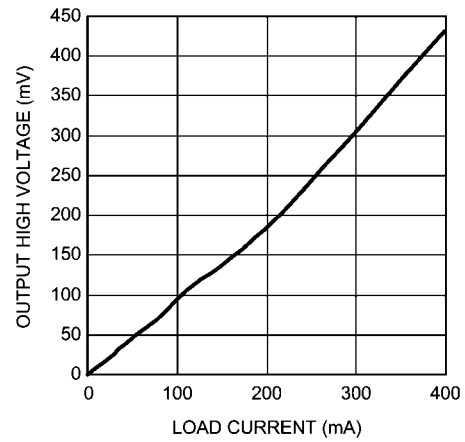

20186310

**Output Voltage vs Input Voltage**  
 $V_{DD} = 3V, R_L = 20\Omega$

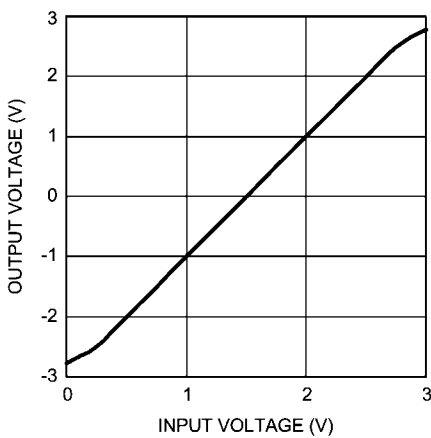

20186314

**Output Voltage vs Input Voltage**  
 $V_{DD} = 3V, R_L = 30\Omega$

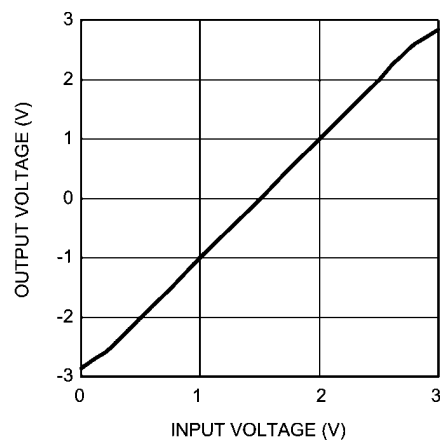

20186315

**Output Voltage vs Input Voltage**  
 $V_{DD} = 5V, R_L = 20\Omega$

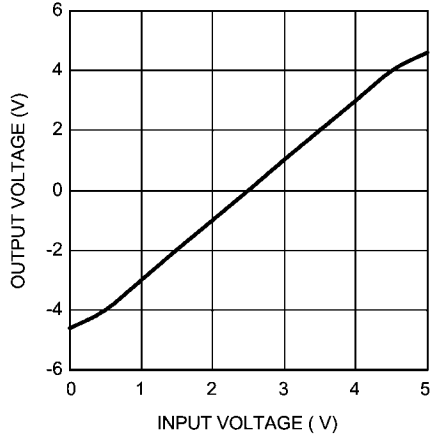

20186316

**Output Voltage vs Input Voltage**  
 $V_{DD} = 5V, R_L = 30\Omega$

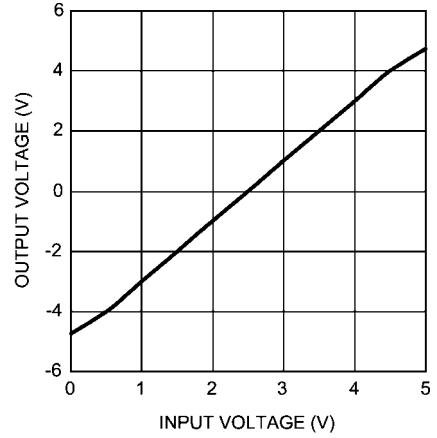

20186317

**Power Dissipation vs Supply Voltage**

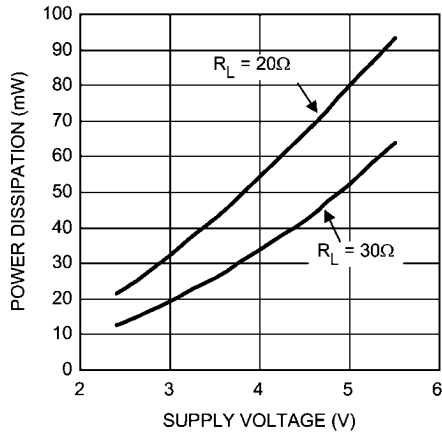

20186320

**Supply Current vs Supply Voltage**

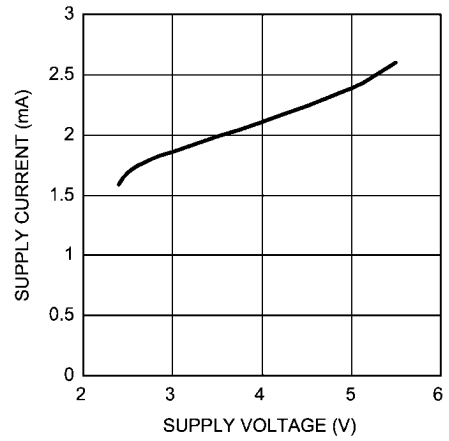

20186321

**Slew Rate vs Supply Voltage**  
 $R_L = 30\Omega$

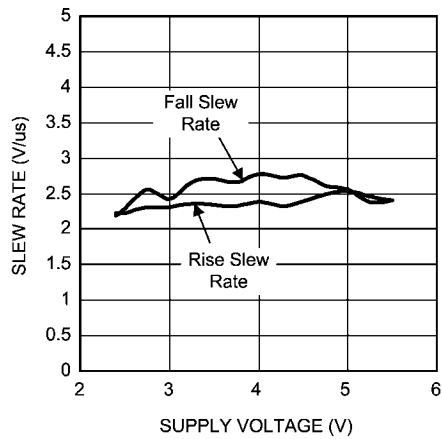

20186319

**Shutdown Supply Current vs Supply Voltage**

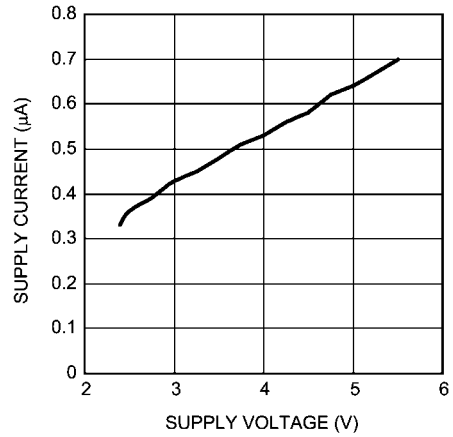

20186323

Output Transition High to Low, Low to High  
 $V_{DD} = 3V$ , 1V/div, 400ns/div

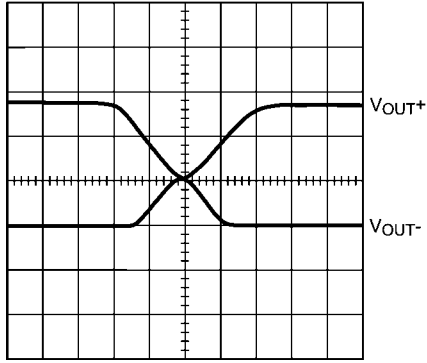

20186306

Output Transition High to Low, Low to High  
 $V_{DD} = 5V$ , 1V/div, 1 $\mu$ s/div

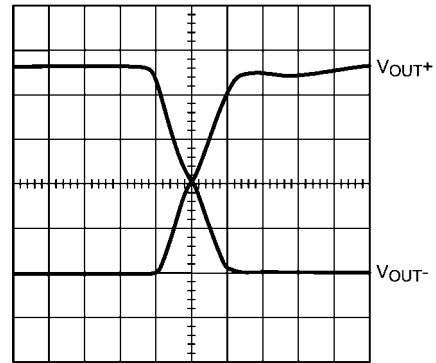

20186307

Turn-Off Time  
 $V_{DD} = 5V$ , 2V/div, 1ms/div

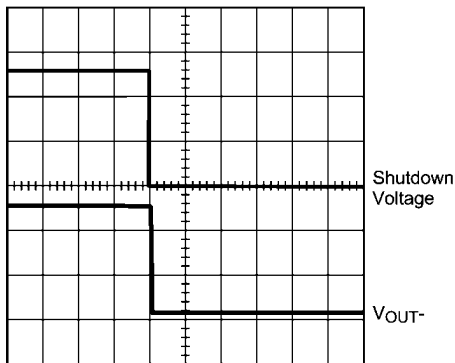

20186308

Turn-On Time  
 $V_{DD} = 5V$ , 2V/div, 1ms/div

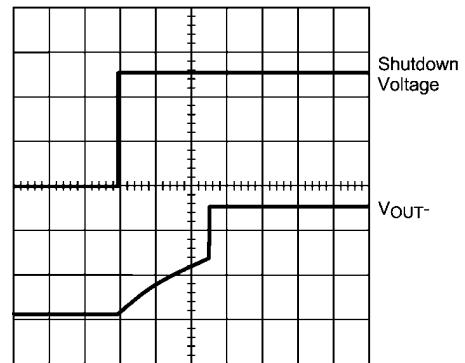

20186309



## Application Information

### BRIDGE CONFIGURATION EXPLANATION

The LM4570 uses a bridged architecture that drives a load differentially. The BTL design offers several advantages over a single-ended design. The device outputs,  $V_{O1}$  and  $V_{O2}$ , both source and sink current, which means that the polarity of the voltage across the motor can be reversed quickly (Figure 2). A single-ended device would need to operate from split supplies to achieve this behavior. The ability to reverse the voltage polarity is necessary in applications where a negative (reverse polarity) pulse is used to quickly stop the motor. If the drive voltage is just removed from the motor (not reversed) then the motor will continue to spin until the residual energy stored in the windings has dissipated.

The output voltage of the LM4570 is determined by the difference between the input voltage and  $V_{REF1}$ , as well as the

differential gain of the device. The output voltage is given by the following:

$$V_{O1} - V_{O2} = A_{VD}(V_{IN} - V_{REF1})$$

For input voltages that are less than the reference voltage, the differential output voltage is negative. For input voltages that are greater than the reference voltage, the differential output voltage is positive. For example, when operating from a 5V supply ( $V_{REF1} = 2.5V$ ) and with a differential gain of 6dB, with a 1V input, the voltage measured across  $V_{O1}$  and  $V_{O2}$  is -3V, with a 4V input, the differential output voltage is +3V.

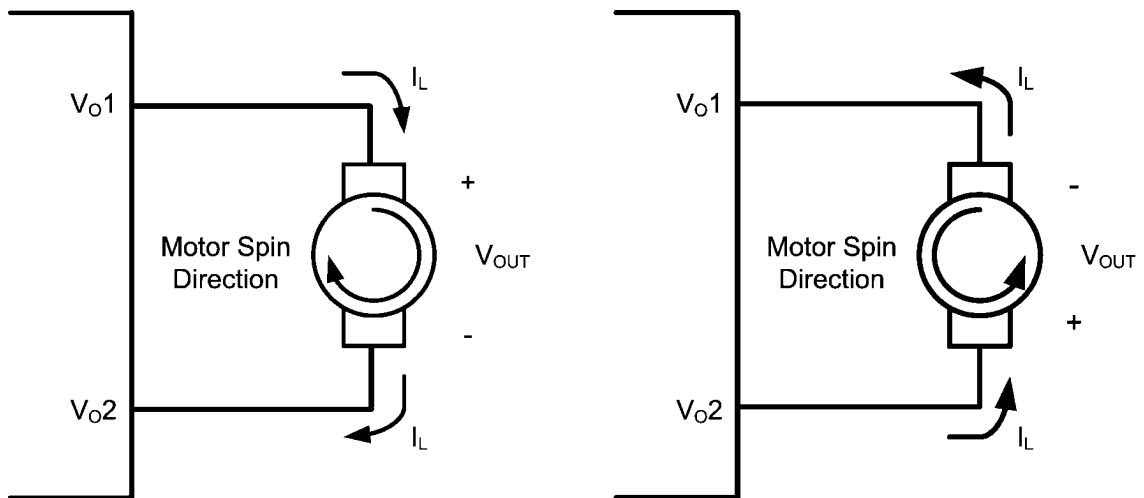

20186302

FIGURE 2. Voltage Polarity and Motor Direction

## GAIN SETTING

The resistors  $R_{IN}$  and  $R_F$  set the gain of the LM4570, given by:

$$V_{VD} = 2 \times (R_F / R_{IN})$$

Where  $A_{VD}$  is the differential gain.  $A_{VD}$  differs from single-ended gain by a factor of 2. This doubling is due to the differential output architecture of the LM4570. Driving the load differentially doubles the output voltage compared to a single-ended output amplifier under the same conditions.

## POWER DISSIPATION

The Power Dissipation vs. Supply Voltage graph in the Operating Curves section shows the power dissipation of the LM4570 with the input equal to the supply voltage, meaning

the outputs swing rail-to-rail. This configuration results in the output devices of the LM4570 operating in the linear region, essentially very small resistors determined by the  $R_{DS(ON)}$  of the output devices. Under these conditions, the power dissipation is dominated by the  $I \cdot R$  drop associated with the output current across the  $R_{DS(ON)}$  of the output transistors, thus the power dissipation is very low (60mW for a 800mW output).

When the input voltage is not equal to GND or  $V_{DD}$ , the power dissipation of the LM4570 increases (Figure 3). Under these conditions, the output devices operate in the saturation region, where the devices consume current in addition to the current being steered to the load, increasing the power dissipation. Power dissipation for typical motor driving applications should not be an issue since the most of the time the device outputs will be driven rail-to-rail.

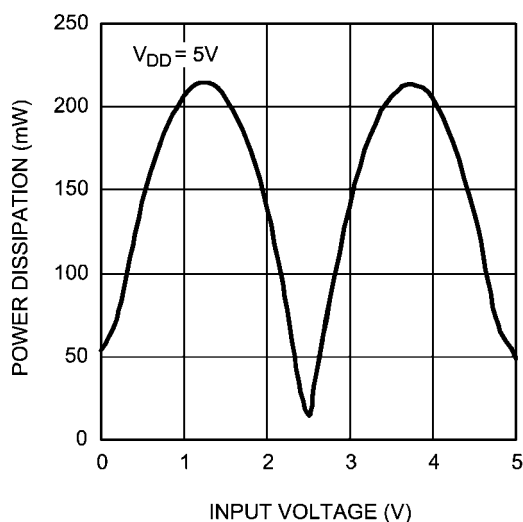

20186328

FIGURE 3. Power Dissipation vs. Input Voltage

## EXPOSED-DAP MOUNTING CONSIDERATIONS

The LM4570 is available in an 8-pin LLP package which features an exposed DAP (die attach paddle). The exposed DAP provides a direct thermal conduction path between the die and the PCB, improving the thermal performance by reducing the thermal resistance of the package. Connect the exposed DAP to GND through a large pad beneath the device, and multiple vias to a large unbroken GND plane. For best thermal performance, connect the DAP pad to a GND plane on an outside layer of the PCB. Connecting the DAP to a plane on an inner layer will result in a higher thermal resistance. Ensure efficient thermal conductivity by plugging and tenting the vias with plating and solder mask, respectively.

## POWER SUPPLY BYPASSING

Good power supply bypassing is critical for proper operation. Locate both the REF1 and  $V_{DD}$  bypass capacitors as close to

the device as possible. Typical applications employ a regulator with a 10 $\mu$ F tantalum or electrolytic capacitor and a ceramic bypass capacitor which aid in supply stability. This does not eliminate the need for bypass capacitors near the LM4570. Place a 1 $\mu$ F ceramic capacitor as close to  $V_{DD}$  as possible. Place a 0.1 $\mu$ F capacitor as close to REF1 as possible. Smaller values of  $C_{REF1}$  may be chosen for decreased turn on times.

## SHUTDOWN FUNCTION

The LM4570 features a low power shutdown mode that disables the device and reduces quiescent current consumption to 0.1 $\mu$ A. Driving /SD Low disables the amplifiers and bias circuitry, and drives  $V_{REF1}$  and the outputs to GND. Connect /SD to  $V_{DD}$  for normal operation.

DEMO BOARD LAYOUT

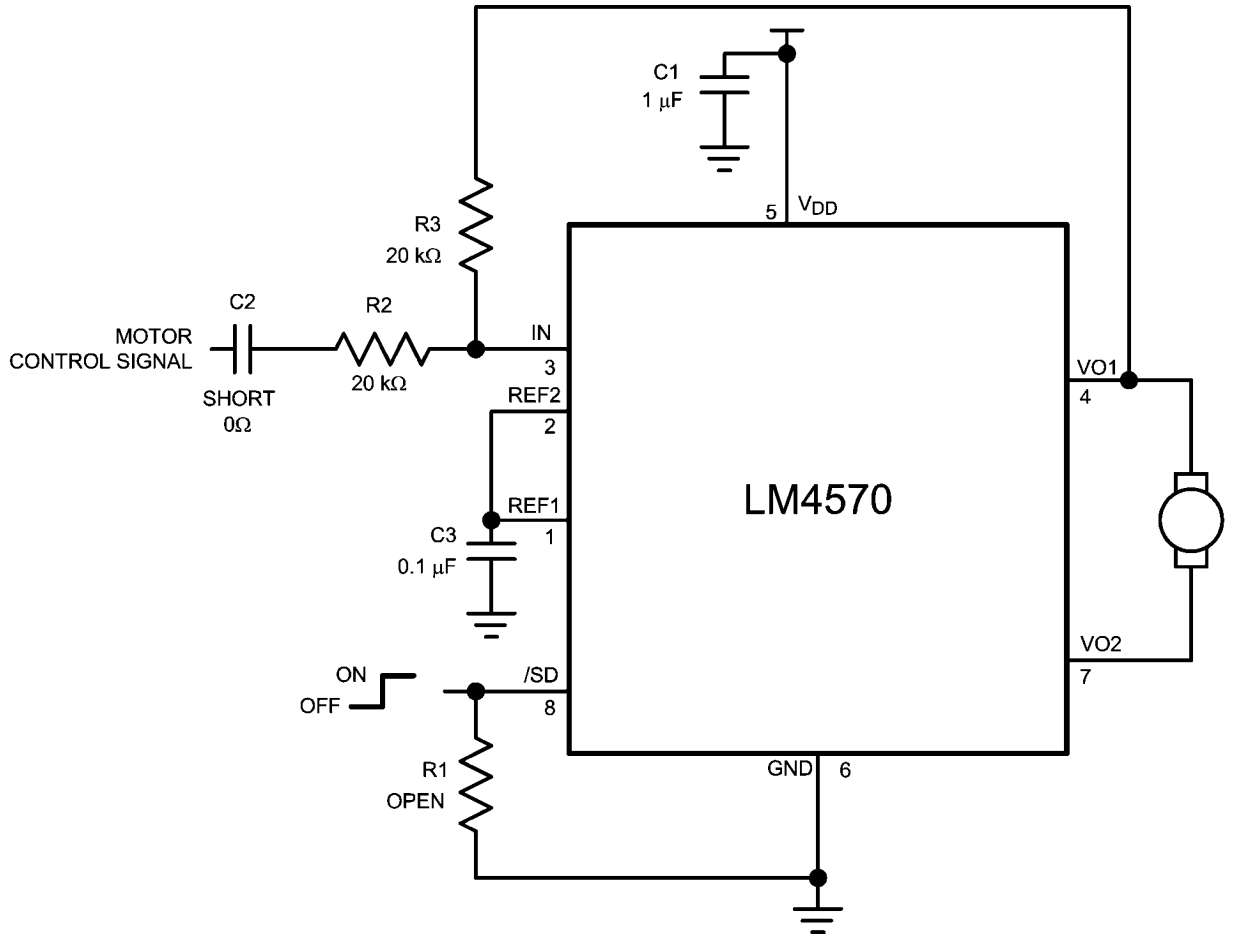

20186324

## Revision History

<b>Rev</b>	<b>Date</b>	<b>Description</b>
1.0	04/13/06	Initial release.
1.01	07/28/09	Added the Ordering Information table.

**Physical Dimensions** inches (millimeters) unless otherwise noted

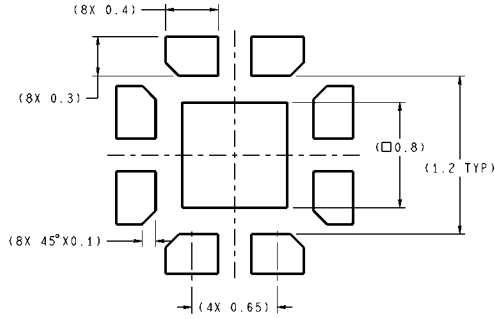

DIMENSIONS ARE IN MILLIMETERS

**RECOMMENDED LAND PATTERN**  
1:1 RATIO WITH PKG SOLDER PADS

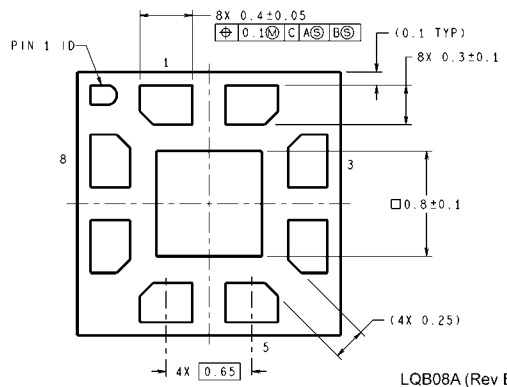
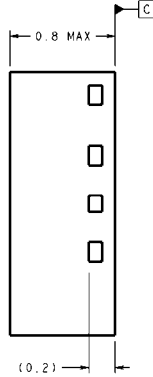
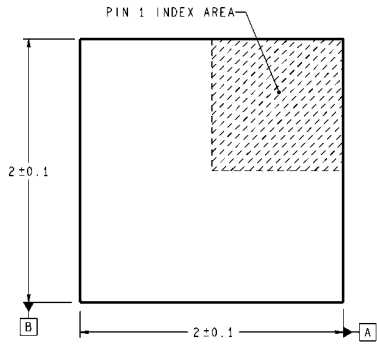

LQB08A (Rev B)

**LLP Package**  
**Order Number LM4570LQ**  
**NS Package Number LQB08A**

# Notes

LM4570

## Notes

For more National Semiconductor product information and proven design tools, visit the following Web sites at:

Products		Design Support	
Amplifiers	<a href="http://www.national.com/amplifiers">www.national.com/amplifiers</a>	WEBENCH® Tools	<a href="http://www.national.com/webench">www.national.com/webench</a>
Audio	<a href="http://www.national.com/audio">www.national.com/audio</a>	App Notes	<a href="http://www.national.com/appnotes">www.national.com/appnotes</a>
Clock and Timing	<a href="http://www.national.com/timing">www.national.com/timing</a>	Reference Designs	<a href="http://www.national.com/refdesigns">www.national.com/refdesigns</a>
Data Converters	<a href="http://www.national.com/adc">www.national.com/adc</a>	Samples	<a href="http://www.national.com/samples">www.national.com/samples</a>
Interface	<a href="http://www.national.com/interface">www.national.com/interface</a>	Eval Boards	<a href="http://www.national.com/evalboards">www.national.com/evalboards</a>
LVDS	<a href="http://www.national.com/lvds">www.national.com/lvds</a>	Packaging	<a href="http://www.national.com/packaging">www.national.com/packaging</a>
Power Management	<a href="http://www.national.com/power">www.national.com/power</a>	Green Compliance	<a href="http://www.national.com/quality/green">www.national.com/quality/green</a>
Switching Regulators	<a href="http://www.national.com/switchers">www.national.com/switchers</a>	Distributors	<a href="http://www.national.com/contacts">www.national.com/contacts</a>
LDOs	<a href="http://www.national.com/ldo">www.national.com/ldo</a>	Quality and Reliability	<a href="http://www.national.com/quality">www.national.com/quality</a>
LED Lighting	<a href="http://www.national.com/led">www.national.com/led</a>	Feedback/Support	<a href="http://www.national.com/feedback">www.national.com/feedback</a>
Voltage Reference	<a href="http://www.national.com/vref">www.national.com/vref</a>	Design Made Easy	<a href="http://www.national.com/easy">www.national.com/easy</a>
PowerWise® Solutions	<a href="http://www.national.com/powerwise">www.national.com/powerwise</a>	Solutions	<a href="http://www.national.com/solutions">www.national.com/solutions</a>
Serial Digital Interface (SDI)	<a href="http://www.national.com/sdi">www.national.com/sdi</a>	Mil/Aero	<a href="http://www.national.com/milaero">www.national.com/milaero</a>
Temperature Sensors	<a href="http://www.national.com/tempensors">www.national.com/tempensors</a>	SolarMagic™	<a href="http://www.national.com/solarmagic">www.national.com/solarmagic</a>
Wireless (PLL/VCO)	<a href="http://www.national.com/wireless">www.national.com/wireless</a>	PowerWise® Design University	<a href="http://www.national.com/training">www.national.com/training</a>

THE CONTENTS OF THIS DOCUMENT ARE PROVIDED IN CONNECTION WITH NATIONAL SEMICONDUCTOR CORPORATION ("NATIONAL") PRODUCTS. NATIONAL MAKES NO REPRESENTATIONS OR WARRANTIES WITH RESPECT TO THE ACCURACY OR COMPLETENESS OF THE CONTENTS OF THIS PUBLICATION AND RESERVES THE RIGHT TO MAKE CHANGES TO SPECIFICATIONS AND PRODUCT DESCRIPTIONS AT ANY TIME WITHOUT NOTICE. NO LICENSE, WHETHER EXPRESS, IMPLIED, ARISING BY ESTOPPEL OR OTHERWISE, TO ANY INTELLECTUAL PROPERTY RIGHTS IS GRANTED BY THIS DOCUMENT.

TESTING AND OTHER QUALITY CONTROLS ARE USED TO THE EXTENT NATIONAL DEEMS NECESSARY TO SUPPORT NATIONAL'S PRODUCT WARRANTY. EXCEPT WHERE MANDATED BY GOVERNMENT REQUIREMENTS, TESTING OF ALL PARAMETERS OF EACH PRODUCT IS NOT NECESSARILY PERFORMED. NATIONAL ASSUMES NO LIABILITY FOR APPLICATIONS ASSISTANCE OR BUYER PRODUCT DESIGN. BUYERS ARE RESPONSIBLE FOR THEIR PRODUCTS AND APPLICATIONS USING NATIONAL COMPONENTS. PRIOR TO USING OR DISTRIBUTING ANY PRODUCTS THAT INCLUDE NATIONAL COMPONENTS, BUYERS SHOULD PROVIDE ADEQUATE DESIGN, TESTING AND OPERATING SAFEGUARDS.

EXCEPT AS PROVIDED IN NATIONAL'S TERMS AND CONDITIONS OF SALE FOR SUCH PRODUCTS, NATIONAL ASSUMES NO LIABILITY WHATSOEVER, AND NATIONAL DISCLAIMS ANY EXPRESS OR IMPLIED WARRANTY RELATING TO THE SALE AND/OR USE OF NATIONAL PRODUCTS INCLUDING LIABILITY OR WARRANTIES RELATING TO FITNESS FOR A PARTICULAR PURPOSE, MERCHANTABILITY, OR INFRINGEMENT OF ANY PATENT, COPYRIGHT OR OTHER INTELLECTUAL PROPERTY RIGHT.

#### LIFE SUPPORT POLICY

**NATIONAL'S PRODUCTS ARE NOT AUTHORIZED FOR USE AS CRITICAL COMPONENTS IN LIFE SUPPORT DEVICES OR SYSTEMS WITHOUT THE EXPRESS PRIOR WRITTEN APPROVAL OF THE CHIEF EXECUTIVE OFFICER AND GENERAL COUNSEL OF NATIONAL SEMICONDUCTOR CORPORATION.** As used herein:

Life support devices or systems are devices which (a) are intended for surgical implant into the body, or (b) support or sustain life and whose failure to perform when properly used in accordance with instructions for use provided in the labeling can be reasonably expected to result in a significant injury to the user. A critical component is any component in a life support device or system whose failure to perform can be reasonably expected to cause the failure of the life support device or system or to affect its safety or effectiveness.

National Semiconductor and the National Semiconductor logo are registered trademarks of National Semiconductor Corporation. All other brand or product names may be trademarks or registered trademarks of their respective holders.

Copyright© 2009 National Semiconductor Corporation

For the most current product information visit us at [www.national.com](http://www.national.com)



**National Semiconductor Americas Technical Support Center**  
Email: [support@nsc.com](mailto:support@nsc.com)  
Tel: 1-800-272-9959

**National Semiconductor Europe Technical Support Center**  
Email: [europe.support@nsc.com](mailto:europe.support@nsc.com)

**National Semiconductor Asia Pacific Technical Support Center**  
Email: [ap.support@nsc.com](mailto:ap.support@nsc.com)

**National Semiconductor Japan Technical Support Center**  
Email: [jpn.feedback@nsc.com](mailto:jpn.feedback@nsc.com)