

Dual Narrow-Band and Wideband RF Transceiver

FEATURES

- ▶ 2 × 2 highly integrated transceiver
- ▶ Frequency range of 30 MHz to 6000 MHz
- ▶ Transmitter and receiver bandwidth from 12 kHz to 40 MHz
- ▶ Two fully integrated, fractional-N, RF synthesizers
- ▶ LVDS and CMOS synchronous serial data interface options
- ▶ Low power monitor and sleep modes
- ▶ Multichip synchronization capabilities
- ▶ Fast frequency hopping
- ▶ Dynamic profile switching for dynamic data rates and sample rates
- ▶ Fully programmable via a 4-wire SPI
- ▶ 12 mm × 12 mm, 196-ball CSP_BGA

APPLICATIONS

- ▶ Mission critical communications
- ▶ Very high frequency (VHF), ultrahigh frequency (UHF), and cellular to 6 GHz
- ▶ Time division duplexing (TDD) and frequency division duplexing (FDD) applications

GENERAL DESCRIPTION

The ADRV9004 is a highly integrated RF transceiver that has dual-channel transmitters, dual-channel receivers, integrated synthesizers, and digital signal processing functions.

The ADRV9004 is a high performance, highly linear, high dynamic range transceiver designed for performance vs. power consumption system optimization. The device is configurable and ideally suited to demanding, low power, portable and battery powered equipment. The ADRV9004 operates from 30 MHz to 6000 MHz and covers the UHF, VHF, industrial, scientific, and medical (ISM) bands, and cellular frequency bands in narrow-band (kHz) and wideband operation up to 40 MHz. The ADRV9004 is capable of both TDD and FDD operation.

The transceiver consists of direct conversion signal paths with state-of-the-art noise figure and linearity. Each complete receiver and transmitter subsystem includes dc offset correction, quadrature error correction (QEC), and programmable digital filters, which eliminate the need for these functions in the digital baseband. In addition, several auxiliary functions, such as auxiliary analog-to-digital converters (ADCs), auxiliary digital-to-analog converters (DACs), and general-purpose inputs/outputs (GPIOs), are integrated to provide additional monitoring and control capability.

The fully integrated phase-locked loops (PLLs) provide high performance, low power, fractional-N frequency synthesis for the transmitter, receiver, and clock sections. Careful design and layout techniques provide the isolation required in high performance personal radio applications.

All voltage controlled oscillator (VCO) and loop filter components are integrated to minimize the external component count. The local oscillators (LOs) have flexible configuration options and include fast lock modes.

The transceiver includes low power sleep and monitor modes to save power and extend the battery life of portable devices while monitoring communications.

The ADRV9004 core can be powered directly from 1.0 V, 1.3 V, and 1.8 V regulators and is controlled via a standard 4-wire serial port. Other voltage supplies are used to provide proper digital interface levels and to optimize the receiver, transmitter, and auxiliary converter performance.

High data rate and low data rate interfaces are supported using configurable CMOS or low voltage differential signaling (LVDS) serial synchronous interface (SSI) choice.

The ADRV9004 is packaged in a 12 mm × 12 mm, 196-ball chip scale package ball grid array (CSP_BGA).

TABLE OF CONTENTS

Features.....	1	Typical Performance Characteristics.....	27
Applications.....	1	Wideband.....	27
General Description.....	1	Narrow-Band.....	65
Functional Block Diagram.....	3	Phase Noise.....	90
Specifications.....	4	Theory of Operation.....	92
Transmitter Specifications.....	4	Transmitter.....	92
Receiver Specifications.....	6	Receiver.....	93
Internal LO, External LO, and Device Clock.....	13	Receiver as an Observation Receiver.....	94
Digital Interfaces and Auxiliary Converters.....	14	Clock Input.....	94
Power Supply Specifications.....	15	Synthesizers.....	94
Current Consumption Estimates (Typical Values).....	16	SPI.....	94
Timing Specifications.....	18	GPIO Pins.....	95
Absolute Maximum Ratings.....	21	Auxiliary Converters.....	95
Reflow Profile.....	21	JTAG Boundary Scan.....	95
Thermal Resistance.....	21	Applications Information.....	97
Electrostatic Discharge (ESD) Ratings.....	21	Power Supply Sequence.....	97
ESD Caution.....	21	Digital Data Interface.....	97
Pin Configuration and Function Descriptions.....	22	Outline Dimensions.....	100
		Ordering Guide.....	100

REVISION HISTORY**7/2022—Rev. 0 to Rev. A**

Changes to Table 2.....	6
Changes to Frequency Step Parameter and Reference Clock (DEV_CLK_IN SIGNAL), Differential Mode, Signal Level Parameter; Table 3.....	13
Changes to Digital Data Timing (LVDS SSI), Transmitter Data Parameter, Table 12.....	18
Change to Table 15.....	21
Changes to Typical Performance Characteristics Section.....	27

5/2021—Revision 0: Initial Version

FUNCTIONAL BLOCK DIAGRAM

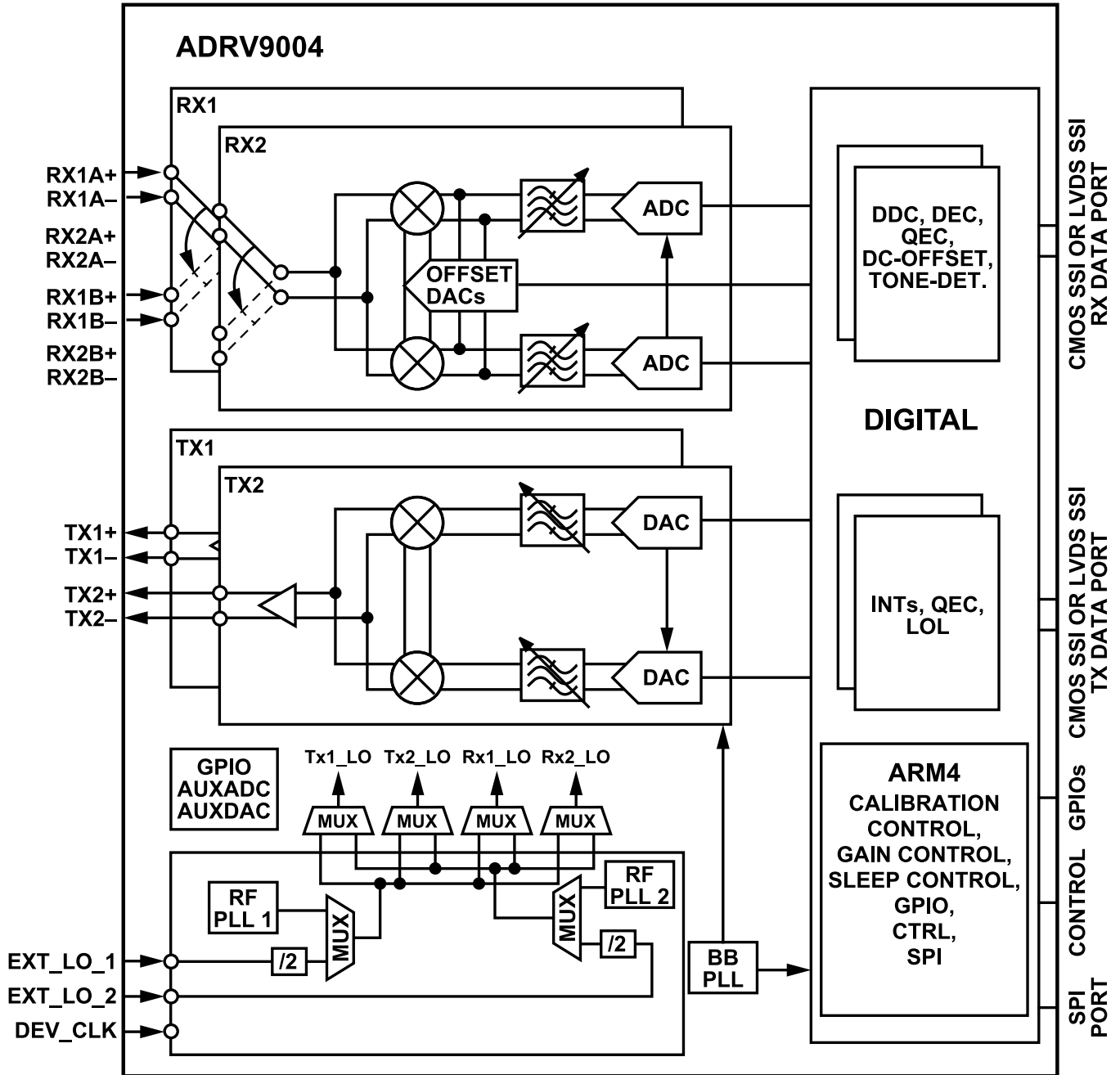

Figure 1.

001

SPECIFICATIONS

Electrical characteristics are at the operating ambient temperature range, VDDA_1P0 = 1.0 V, VDDA_1P3 = 1.3 V, VDDA_1P8 = 1.8 V, VDD_1P0 = 1.0 V, and VDD_1P8 = 1.8 V.

TRANSMITTER SPECIFICATIONS

Table 1. Transmitters (Tx1 and Tx2)

Parameter	Symbol	Min	Typ	Max	Unit	Test Conditions/Comments
CENTER FREQUENCY		30		6000	MHz	
TRANSMITTER SYNTHESIS BANDWIDTH		0.012		40	MHz	Zero-IF mode
BANDWIDTH FLATNESS			0.1		dB	10 MHz bandwidth span, including digital compensation
DEVIATION FROM LINEAR PHASE			1		Degrees	40 MHz bandwidth
POWER CONTROL RANGE						
In-Phase (I) and Quadrature (Q) Mode			42		dB	
Direct Modulation Mode			12		dB	
POWER CONTROL RESOLUTION						
I and Q Mode			0.05		dB	
Direct Modulation Mode			0.5		dB	
IN BAND NOISE FLOOR			-154		dBFS ¹ /Hz	0 dB attenuation, in band noise falls 1 dB for each dB of attenuation for attenuation settings between 0 dB and 20 dB
OUT OF BAND NOISE FLOOR			-156		dBFS/Hz	0 dB attenuation with 3 × bandwidth/2 offset
Tx1 TO Tx2 ISOLATION						
30 MHz			98		dB	
470 MHz			97		dB	
900 MHz			93		dB	
2400 MHz			93		dB	
3500 MHz			79		dB	
5800 MHz			70		dB	
IMAGE REJECTION WITH INITIALIZATION CALIBRATION ONLY						
Wideband						Up to 20 dB transmitter attenuation, 40 MHz bandwidth, 0 dB observation receiver attenuation, 18 MHz continuous wave ² signal input, QEC ³ tracking calibration is disabled
50 MHz			55		dBc	
470 MHz			63		dBc	
900 MHz			59		dBc	
2400 MHz			60		dBc	
3500 MHz			57		dBc	
5800 MHz			55		dBc	
Narrow-Band						Up to 20 dB transmitter attenuation, 25 kHz bandwidth, 0 dB observation receiver attenuation, 2.1 kHz continuous wave ² signal input, QEC tracking calibration is disabled
30 MHz			61		dBc	
470 MHz			68		dBc	
900 MHz			65		dBc	
2400 MHz			60		dBc	
3500 MHz			50		dBc	
5800 MHz			50		dBc	

SPECIFICATIONS

Table 1. Transmitters (Tx1 and Tx2)

Parameter	Symbol	Min	Typ	Max	Unit	Test Conditions/Comments
IMAGE REJECTION WITH INITIALIZATION CALIBRATION AND TRACKING CALIBRATION Wideband						0 dB transmitter attenuation, 40 MHz bandwidth, -0.2 dBFS, 18 MHz continuous wave ² signal input, 50 Ω load, 0 dB observation receiver attenuation, QEC is active
50 MHz			57		dBc	
470 MHz			66		dBc	
900 MHz			63		dBc	
2400 MHz			60		dBc	
3500 MHz			61		dBc	
5800 MHz			57		dBc	
CONTINUOUS WAVE FULL-SCALE OUTPUT POWER						-0.2 dBFS, 18 MHz continuous wave ² signal input, 50 Ω load, 0 dB transmitter attenuation
30 MHz			7.3		dBm	
470 MHz			7.3		dBm	
900 MHz			7.6		dBm	
2400 MHz			7.4		dBm	
3500 MHz			7.8		dBm	
5800 MHz			7.2		dBm	
OUTPUT IMPEDANCE	Z _{OUT}		50		Ω	Differential, see the ADRV9001 system development user guide for more information
MAXIMUM OUTPUT LOAD VOLTAGE STANDING WAVE RATIO (VSWR)				3		Use the maximum value to ensure adequate calibration
OUTPUT RETURN LOSS						Single-ended return loss measured with balun in place on board
30 MHz			17		dB	
470 MHz			18		dB	
900 MHz			17		dB	
2400 MHz			23		dB	
3500 MHz			13		dB	
5800 MHz			10		dB	
OUTPUT THIRD-ORDER INTERCEPT POINT						0 dB transmitter attenuation, 40 MHz bandwidth, 17 MHz and 18 MHz continuous wave ² signal input, digital backoff = 11 dBFS/tone, calibrated at the device output
Wideband	OIP _{3WB}					
50 MHz			31		dBm	
470 MHz			31		dBm	
900 MHz			30		dBm	
2400 MHz			28		dBm	
3500 MHz			29		dBm	
5800 MHz			27		dBm	
Narrow-Band	OIP _{3NB}					0 dB transmitter attenuation, 25 kHz bandwidth, 2.1 kHz and 3.1 kHz continuous wave ² signal input, digital backoff = 5 dBFS/tone, calibrated at the device output
30 MHz			30		dBm	
470 MHz			31		dBm	
900 MHz			30		dBm	
2400 MHz			28		dBm	
3500 MHz			27		dBm	
5800 MHz			25		dBm	

SPECIFICATIONS

Table 1. Transmitters (Tx1 and Tx2)

Parameter	Symbol	Min	Typ	Max	Unit	Test Conditions/Comments
CARRIER LEAKAGE WITH INITIALIZATION CALIBRATION ONLY						LO leakage tracking calibration disabled, 0 dB transmitter attenuation, scales dB for dB with attenuation, input tone backoff = 6 dBFS
Wideband						
50 MHz			-68		dBm	
470 MHz			-65		dBm	
900 MHz			-67		dBm	
2400 MHz			-68		dBm	
3500 MHz			-62		dBm	
5800 MHz			-56		dBm	
Narrow-Band						
30 MHz			-70		dBm	
470 MHz			-72		dBm	
900 MHz			-74		dBm	
2400 MHz			-71		dBm	
3500 MHz			-71		dBm	
5800 MHz			-58		dBm	

¹ dBFS represents the ratio of the actual output signal to the maximum possible output level for a continuous wave output signal at the given RF attenuation setting.

² A continuous wave is a single frequency signal.

³ Quadrature error correction (QEC) is the system for minimizing quadrature images of a desired signal.

RECEIVER SPECIFICATIONS

Table 2. Receivers (Rx1A, Rx1B, Rx2A, and Rx2B)

Parameter	Symbol	Min	Typ	Max	Unit	Test Conditions/Comments
CENTER FREQUENCY		30		6000	MHz	
MAXIMUM GAIN						
Wideband						High performance receiver ADCs, 0 dB attenuation, 5.6 MHz baseband frequency
50 MHz			21		dB	
470 MHz			22		dB	
900 MHz			22		dB	
2400 MHz			22		dB	
3500 MHz			21		dB	
5800 MHz			21		dB	
Narrow-Band						High performance receiver ADCs, 0 dB attenuation, 2.1 kHz baseband frequency
30 MHz			21		dB	
470 MHz			22		dB	
900 MHz			22		dB	
2400 MHz			22		dB	
3500 MHz			21		dB	
5800 MHz			21		dB	
ATTENUATION RANGE FROM MAXIMUM GAIN			34		dB	
Attenuation Accuracy						
Gain Step			0.5		dB	Attenuator steps from 0 dB to 30 dB
Gain Step Error			1.0		dB	Attenuator steps from 30 dB to 34 dB
Gain Step Error			0.1		dB	Attenuation step from 0 dB to 30 dB, LO from 30 MHz to 3 GHz
Gain Step Error			0.2		dB	Attenuation step from 0 dB to 30 dB, LO from 3 GHz to 6 GHz

SPECIFICATIONS

Table 2. Receivers (Rx1A, Rx1B, Rx2A, and Rx2B)

Parameter	Symbol	Min	Typ	Max	Unit	Test Conditions/Comments
			0.1		dB	Attenuation step from 30 dB to 34 dB
FREQUENCY RESPONSE						
Peak-to-Peak Gain Deviation			1		dB	40 MHz bandwidth including digital compensation
			0.2		dB	Any 10 MHz span including digital compensation
RECEIVER BANDWIDTH		0.012		40	MHz	Zero-IF mode, the analog low-pass filter (LPF) bandwidth is 5 MHz minimum, the programmable finite impulse response (FIR) filter bandwidth is configurable over the entire range
RECEIVER ALIAS BAND REJECTION		80			dB	This performance is achieved because of the digital filters
CONTINUOUS WAVE FULL-SCALE INPUT POWER ¹	FSIP		-11.4		dBm	This continuous wave signal level corresponds to the input power at maximum gain that produces 0 dBFS at the ADC output, this level increases dB for dB with attenuation, backoff by at least -2 dBFS is required
INPUT IMPEDANCE			100		Ω	Differential, see the ADRV9001 system development user guide for more information
INPUT PORT RETURN LOSS						Single-ended return loss measured with balun in place on board
30 MHz			20		dB	
470 MHz			21		dB	
900 MHz			20		dB	
2400 MHz			22		dB	
3500 MHz			9		dB	
5800 MHz			10		dB	
NOISE FIGURE						
High Performance Receiver ADCs						
Wideband	NF _{WB}					0 dB attenuation at the device under test (DUT) receive port, integrated bandwidth from 8 MHz to 9 MHz
50 MHz			11.6		dB	
470 MHz			10.6		dB	
900 MHz			10.5		dB	
2400 MHz			11.4		dB	
3500 MHz			12.5		dB	
5800 MHz			12.6		dB	
Narrow-Band	NF _{NB}					0 dB attenuation at the device under test (DUT) receive port, integrated bandwidth from 4 kHz to 8 kHz, 18 dB interface gain, intermediate frequency (IF) = 490 kHz
30 MHz			13.8		dB	
470 MHz			11.8		dB	
900 MHz			11.8		dB	
2400 MHz			12.3		dB	
3500 MHz			14.2		dB	
5800 MHz			15.1		dB	
Low Power Receiver ADCs						
Wideband	NF _{WB}					0 dB attenuation at the DUT receive port, integrated bandwidth from 8 MHz to 9 MHz
50 MHz			13.1		dB	
470 MHz			11.9		dB	
900 MHz			12.0		dB	
2400 MHz			12.6		dB	
3500 MHz			13.6		dB	
5800 MHz			13.9		dB	
Narrow-Band	NF _{NB}					0 dB attenuation at the DUT receive port, integrated bandwidth from 4 kHz to 8 kHz, 18 dB interface gain, IF = 490 kHz

SPECIFICATIONS

Table 2. Receivers (Rx1A, Rx1B, Rx2A, and Rx2B)

Parameter	Symbol	Min	Typ	Max	Unit	Test Conditions/Comments
30 MHz			16.7		dB	
470 MHz			14.8		dB	
900 MHz			15.1		dB	
2400 MHz			15.6		dB	
3500 MHz			17.0		dB	
5800 MHz			17.5		dB	
SECOND-ORDER INPUT INTERMODULATION INTERCEPT POINT						
High Performance Receiver ADCs						
Wideband	IIP2 _{WB}					0 dB receiver attenuation, 1 dB cutoff frequency (f_{1dB}) of the transimpedance amplifier (TIA) = 20 MHz, two continuous wave tones at 17 MHz and 18 MHz, for LO = 50 MHz, tone output power is -11.6 dBFS/tone, for all other LOs, tone output power is -8.1 dBFS/tone
50 MHz			79		dBm	
470 MHz			81		dBm	
900 MHz			85		dBm	
2400 MHz			73		dBm	
3500 MHz			60		dBm	
5800 MHz			60		dBm	
Narrow-Band	IIP2 _{NB}					0 dB receiver attenuation, 3 dB cutoff frequency (f_{3dB}) of the first order transimpedance amplifier (TIA) = 4 MHz, two continuous wave tones at 1.0061 MHz and 2.0061 MHz, for LO = 30 MHz, 470 MHz, 900 MHz and 2400 MHz, tone output power is -11.6 dBFS/tone, for LO = 3500 MHz and 5800 MHz, tone output power is -6.6 dBFS/tone
30 MHz			90		dBm	
470 MHz			89		dBm	
900 MHz			85		dBm	
2400 MHz			70		dBm	
3500 MHz			73		dBm	
5800 MHz			67		dBm	
Low Power Receiver ADCs						
Wideband	IIP2 _{WB}					0 dB receiver attenuation, f_{1dB} of the TIA = 20 MHz, two continuous wave tones at 17 MHz and 18 MHz, for LO = 50 MHz, tone output power is -11.6 dBFS/tone, for all other LOs, tone output power is -8.1 dBFS/tone
50 MHz			70		dBm	
470 MHz			74		dBm	
900 MHz			72		dBm	
2400 MHz			65		dBm	
3500 MHz			59		dBm	
5800 MHz			60		dBm	
Narrow-Band	IIP2 _{NB}					0 dB receiver attenuation, 3 dB cutoff frequency (f_{3dB}) of the first order transimpedance amplifier (TIA) = 4 MHz, two continuous wave tones at 1.0061 MHz and 2.0061 MHz, for LO = 30 MHz, 470 MHz, 900 MHz and 2400 MHz, tone output power is -11.6 dBFS/tone, for LO = 3500 MHz and 5800 MHz, tone output power is -6.6 dBFS/tone
30 MHz			82		dBm	
470 MHz			84		dBm	
900 MHz			81		dBm	
2400 MHz			68		dBm	
3500 MHz			71		dBm	
5800 MHz			67		dBm	

SPECIFICATIONS

Table 2. Receivers (Rx1A, Rx1B, Rx2A, and Rx2B)

Parameter	Symbol	Min	Typ	Max	Unit	Test Conditions/Comments
THIRD-ORDER INPUT INTERMODULATION INTERCEPT POINT, DIFFERENCE PRODUCT						
High Performance Receiver ADCs						
Wideband	IIP3 _{WB}					0 dB receiver attenuation, f_{1dB} of the TIA = 20 MHz, two continuous wave tones at 17 MHz and 18 MHz, for LO = 50 MHz, tone output power is -11.6 dBFS/tone, for all other LOs, tone output power is -8.1 dBFS/tone
50 MHz			22		dBm	
470 MHz			26		dBm	
900 MHz			27		dBm	
2400 MHz			28		dBm	
3500 MHz			26		dBm	
5800 MHz			25		dBm	
Narrow-Band	IIP3 _{NB}					0 dB receiver attenuation, for LO = 30 MHz, second order TIA is used and f_{1dB} of the TIA = 7 MHz, for all others, first order TIA is used and f_{1dB} of the TIA = 4 MHz, two continuous wave tones at 1.0061 MHz and 2.0061 MHz, for LO = 30 MHz and 900 MHz, tone output power is -15.1 dBFS/tone, for LO = 470 MHz and 2400 MHz, tone output power is -13.6 dBFS/tone, for LO = 3500 MHz, tone output power is -12.6 dBFS/tone, for LO = 5800 MHz, tone output power is -14 dBFS/tone
30 MHz			31		dBm	
470 MHz			33		dBm	
900 MHz			29		dBm	
2400 MHz			26		dBm	
3500 MHz			27		dBm	
5800 MHz			23		dBm	
Low Power Receiver ADCs						
Wideband	IIP3 _{WB}					0 dB receiver attenuation, f_{1dB} of the TIA = 20 MHz, two continuous wave tones at 17 MHz and 18 MHz, for LO = 50 MHz, tone output power is -11.6 dBFS/tone, for all other LOs, tone output power is -8.1 dBFS/tone
50 MHz			21		dBm	
470 MHz			22		dBm	
900 MHz			22		dBm	
2400 MHz			21		dBm	
3500 MHz			23		dBm	
5800 MHz			20		dBm	
Narrow-Band	IIP3 _{NB}					0 dB receiver attenuation, for LO = 30 MHz, second order TIA is used and f_{1dB} of the TIA = 7 MHz, for all others, first order TIA is used and f_{1dB} of the TIA = 4 MHz, two continuous wave tones at 1.0061 MHz and 2.0061 MHz, for LO = 30 MHz and 900 MHz, tone output power is -15.1 dBFS/tone, for LO = 470 MHz and 2400 MHz, tone output power is -13.6 dBFS/tone, for LO = 3500 MHz, tone output power is -12.6 dBFS/tone, for LO = 5800 MHz, tone output power is -14 dBFS/tone
30 MHz			23		dBm	
470 MHz			23		dBm	
900 MHz			21		dBm	
2400 MHz			22		dBm	
3500 MHz			26		dBm	
5800 MHz			21		dBm	
THIRD-ORDER HARMONIC DISTORTION						
High Performance Receiver ADCs						

SPECIFICATIONS

Table 2. Receivers (Rx1A, Rx1B, Rx2A, and Rx2B)

Parameter	Symbol	Min	Typ	Max	Unit	Test Conditions/Comments
Wideband	HD3 _{WB}					-20 dBm input power continuous wave tone at 5.6 MHz at maximum gain at Rx input port, f_{1dB} of the TIA = 20 MHz, HD3 product at 16.8 MHz
50 MHz			-84		dBc	
470 MHz			-74		dBc	
900 MHz			-82		dBc	
2400 MHz			-92		dBc	
3500 MHz			-93		dBc	
5800 MHz			-89		dBc	
Narrow-Band	HD3 _{NB}					-20 dBm input power continuous wave tone at 2.1 kHz at maximum gain at Rx input port, f_{1dB} of the TIA = 2 MHz, HD3 product at 6.3 kHz
30 MHz			-102		dBc	
470 MHz			-97		dBc	
900 MHz			-89		dBc	
2400 MHz			-79		dBc	
3500 MHz			-80		dBc	
5800 MHz			-72		dBc	
Low Power Receiver ADCs						
Wideband	HD3 _{WB}					-20 dBm input power continuous wave tone at 5.6 MHz at maximum gain at Rx input port, f_{1dB} of the TIA = 20 MHz, HD3 product at 16.8 MHz
50 MHz			-90		dBc	
470 MHz			-71		dBc	
900 MHz			-79		dBc	
2400 MHz			-81		dBc	
3500 MHz			-82		dBc	
5800 MHz			-84		dBc	
Narrow-Band	HD3 _{NB}					-20 dBm input power continuous wave tone at 2.1 kHz at maximum gain at Rx input port, f_{1dB} of the TIA = 2 MHz, HD3 product at 6.3 kHz
30 MHz			-108		dBc	
470 MHz			-95		dBc	
900 MHz			-89		dBc	
2400 MHz			-81		dBc	
3500 MHz			-80		dBc	
5800 MHz			-71		dBc	
SECOND-ORDER HARMONIC DISTORTION						
High Performance Receiver ADCs						
Wideband	HD2 _{WB}					-20 dBm input power continuous wave tone at 5.6 MHz at maximum gain at Rx input port, f_{1dB} of the TIA = 20 MHz, HD2 product at 11.2 MHz
50 MHz			-91		dBc	
470 MHz			-93		dBc	
900 MHz			-93		dBc	
2400 MHz			-89		dBc	
3500 MHz			-83		dBc	
5800 MHz			-82		dBc	
Narrow-Band	HD2 _{NB}					-20 dBm input power continuous wave tone at 2.1 kHz at maximum gain at Rx input port, f_{1dB} of the TIA = 2 MHz, HD2 product at 4.2 kHz
30 MHz			-102		dBc	
470 MHz			-96		dBc	
900 MHz			-90		dBc	
2400 MHz			-79		dBc	

SPECIFICATIONS

Table 2. Receivers (Rx1A, Rx1B, Rx2A, and Rx2B)

Parameter	Symbol	Min	Typ	Max	Unit	Test Conditions/Comments
3500 MHz			-80		dBc	
5800 MHz			-71		dBc	
Low Power Receiver ADCs						
Wideband	HD2 _{WB}					-20 dBm input power continuous wave tone at 5.6 MHz at maximum gain at Rx input port, f_{1dB} of the TIA = 20 MHz, HD2 product at 11.2 MHz
50 MHz			-92		dBc	
470 MHz			-92		dBc	
900 MHz			-91		dBc	
2400 MHz			-89		dBc	
3500 MHz			-84		dBc	
5800 MHz			-79		dBc	
Narrow-Band	HD2 _{NB}					-20 dBm input power continuous wave tone at 2.1 kHz at maximum gain at Rx input port, f_{1dB} of the TIA = 2 MHz, HD2 product at 4.2 kHz
30 MHz			-109		dBc	
470 MHz			-94		dBc	
900 MHz			-90		dBc	
2400 MHz			-81		dBc	
3500 MHz			-80		dBc	
5800 MHz			-70		dBc	
IMAGE REJECTION WITH INITIALIZATION CALIBRATION AND HARDWARE TRACKING ONLY						
High Performance Receiver ADCs						
Wideband						Software QEC disabled, 40 MHz receiver bandwidth, maximum receiver gain index, -20 dBm input power continuous wave tone at 5.6 MHz
50 MHz			84		dBc	
470 MHz			83		dBc	
900 MHz			82		dBc	
1900 MHz			81		dBc	
3500 MHz			82		dBc	
5800 MHz			78		dBc	
Narrow-Band						25 KHz receiver bandwidth, maximum receiver gain index, -20 dBm input power continuous wave tone at 2100 KHz
30 MHz			102		dBc	
470 MHz			96		dBc	
900 MHz			95		dBc	
2400 MHz			92		dBc	
3500 MHz			89		dBc	
5800 MHz			86		dBc	
Low Power Receiver ADCs						
Wideband						Software QEC disabled, 40 MHz receiver bandwidth, maximum receiver gain index, -20 dBm input power continuous wave tone at 5.6 MHz
50 MHz			87		dBc	
470 MHz			90		dBc	
900 MHz			86		dBc	
1900 MHz			84		dBc	
3500 MHz			82		dBc	
5800 MHz			75		dBc	
Narrow-Band						25 KHz receiver bandwidth, maximum receiver gain index, -20 dBm input power continuous wave tone at 2100 KHz

SPECIFICATIONS

Table 2. Receivers (Rx1A, Rx1B, Rx2A, and Rx2B)

Parameter	Symbol	Min	Typ	Max	Unit	Test Conditions/Comments
30 MHz			99		dBc	
470 MHz			98		dBc	
900 MHz			98		dBc	
2400 MHz			93		dBc	
3500 MHz			89		dBc	
5800 MHz			87		dBc	
RECEIVER INPUT LO LEAKAGE AT MAXIMUM GAIN						Leakage decreased dB for dB with attenuation for the first 12 dB
50 MHz			-66		dBm	
470 MHz			-66		dBm	
900 MHz			-66		dBm	
2400 MHz			-66		dBm	
3500 MHz			-62		dBm	
5800 MHz			-60		dBm	
SIGNAL ISOLATION						
Tx1 to Rx1A or Rx1B Signal Isolation and Tx2 to Rx2A or Rx2B Signal Isolation						Isolation between Tx and Rx port, isolation changes dB for dB with Rx gain
30 MHz			100		dB	
470 MHz			85		dB	
900 MHz			78		dB	
2400 MHz			77		dB	
3500 MHz			62		dB	
5800 MHz			64		dB	
Tx1 to Rx2A or Rx2B Isolation and Tx2 to Rx1A or Rx2B Signal Isolation						Isolation between Tx and Rx port, isolation changes dB for dB with Rx gain
30 MHz			120		dB	
470 MHz			110		dB	
900 MHz			100		dB	
2400 MHz			90		dB	
3500 MHz			74		dB	
5800 MHz			81		dB	
Rx1A or Rx1B to Rx2A or Rx2B Signal Isolation						
30 MHz			106		dB	
470 MHz			103		dB	
900 MHz			98		dB	
2400 MHz			92		dB	
3500 MHz			83		dB	
5800 MHz			71		dB	
Rx1A to Rx1B and Rx2A to Rx2B Signal Isolation						
30 MHz			99		dB	
470 MHz			97		dB	
900 MHz			90		dB	
2400 MHz			86		dB	
3500 MHz			84		dB	

SPECIFICATIONS

Table 2. Receivers (Rx1A, Rx1B, Rx2A, and Rx2B)

Parameter	Symbol	Min	Typ	Max	Unit	Test Conditions/Comments
5800 MHz			70		dB	

¹ Note that the input signal power limit does not correspond to 0 dBFS at the digital output because of the nature of the continuous time Σ - Δ ADCs. Unlike the hard clipping characteristic of pipeline ADCs, these converters exhibit a soft overload behavior when the input approaches the maximum level.

INTERNAL LO, EXTERNAL LO, AND DEVICE CLOCK

Table 3.

Parameter	Symbol	Min	Typ	Max	Unit	Test Conditions/Comments
LO						
Frequency Step				2.2	Hz	For 38.4 MHz DEV_CLK ¹ , use the equation $DEV_CLK/((2^{23} - 15) \times 2)$ to calculate, assuming the LO divider is 2 LO < 1 GHz, PLL bandwidth = 300 kHz
Reference Spurs			-80		dBc	
LO WITH HIGH PERFORMANCE MODE						
Integrated Phase Noise						Integrated from 100 Hz to 50 MHz PLL bandwidth = 300 kHz PLL bandwidth = 300 kHz PLL bandwidth = 300 kHz PLL bandwidth = 300 kHz PLL bandwidth = 300 kHz PLL bandwidth = 300 kHz PLL bandwidth = 300 kHz DEV_CLK = 38.4 MHz, typical performance PLL bandwidth = 300 kHz PLL bandwidth = 300 kHz PLL bandwidth = 300 kHz PLL bandwidth = 300 kHz PLL bandwidth = 300 kHz PLL bandwidth = 300 kHz
30 MHz LO			0.008		°rms	
470 MHz LO			0.04		°rms	
900 MHz LO			0.08		°rms	
2400 MHz LO			0.22		°rms	
3500 MHz LO			0.27		°rms	
5800 MHz LO			0.6		°rms	
Phase Noise						
30 MHz LO			See Figure 354			
470 MHz LO			See Figure 355			
900 MHz LO			See Figure 356			
2400 MHz LO			See Figure 357			
3500 MHz LO			See Figure 358			
5800 MHz LO			See Figure 359			
LO PHASE SYNCHRONIZATION						
Initial Phase Synchronization Accuracy			3		Degrees	
EXTERNAL LO INPUT						
Input Frequency						Input frequency must be 2× or higher than the desired frequency for the LO frequency (f_{LO}), a 1× multiplier is available for an LO range from 500 MHz to 1 GHz
	f_{EXTLO}	60		12000	MHz	
Input Signal Power		-6	0	+6	dBm	50 Ω matching at the source Do not exceed 20 degrees to ensure adequate quadrature error correction
Input Signal Differential Phase Balance				20	Degrees	
Input Signal Differential Amplitude Balance				1	dB	Differential, see the ADRV9001 system development user guide for more information
Input Signal Duty Cycle				2.5	%	
Input Impedance				100	Ω	
REFERENCE CLOCK (DEV_CLK_IN SIGNAL)						
Differential mode						
Frequency Range		10		1000	MHz	

SPECIFICATIONS

Table 3.

Parameter	Symbol	Min	Typ	Max	Unit	Test Conditions/Comments
Signal Level		0.2		0.4	V p-p	AC-coupled, for optimal spurious performance and to meet the specified PLL performance parameters, use a 400 mV p-p (800 mV p-p differential) input clock
Single-Ended Mode						
Frequency Range		10		80	MHz	
Signal Level		0.2		1	V p-p	AC-coupled, for optimal spurious performance and to meet the specified PLL performance parameters, use a 1 V p-p input clock
REFERENCE CLOCK (XTAL)						
Frequency Range		20		80	MHz	
CLOCK OUTPUT (DEV_CLK_OUT SIGNAL)						
Frequency Range		10		80	MHz	

¹ DEV_CLK is the device clock frequency rate.

DIGITAL INTERFACES AND AUXILIARY CONVERTERS

Table 4.

Parameter	Min	Typ	Max	Unit	Test Conditions/Comments
AUXILIARY ADC CONVERTERS					
Resolution		10		Bits	
Input Voltage					
Minimum		0.05		V	
Maximum		0.95		V	
AUXILIARY DAC CONVERTERS					
Resolution		12		Bits	
Output Voltage					
Minimum		0.05		V	
Maximum		VDDA_1P8 ¹ - 0.05		V	
Drive Capability		10		mA	
DIGITAL SPECIFICATIONS (CMOS SSI SIGNALS)					
Logic Inputs					
Input Voltage					
High Level	VDIGIO_1P8 × 0.65		VDIGIO_1P8 + 0.18	V	
Low Level	-0.30		VDIGIO_1P8 × 0.35	V	
Logic Outputs					
Output Voltage					
High Level	VDIGIO_1P8 - 0.45			V	
Low Level			0.45	V	
Drive Capability		10		mA	
DIGITAL SPECIFICATIONS (DIGITAL GPIO SIGNALS)					
Logic Inputs					

SPECIFICATIONS

Table 4.

Parameter	Min	Typ	Max	Unit	Test Conditions/Comments
Input Voltage					
High Level	$V_{DIGIO_1P8} \times 0.65$		$V_{DIGIO_1P8} + 0.18$	V	
Low Level	-0.30		$V_{DIGIO_1P8} \times 0.35$	V	
Logic Outputs					
Output Voltage					
High Level	$V_{DIGIO_1P8} - 0.45$			V	
Low Level			0.45	V	
Drive Capability		10		mA	
DATAPORT SPECIFICATIONS (LVDS SSI, MCS+ and MCS-)					
Logic Inputs					
Input Voltage Range	825		1675	mV	Each differential input in the pair
Input Differential Voltage Threshold	-100		+100	mV	
Receiver Differential Input Impedance		100		Ω	Internal termination enabled
Logic Outputs					
Output Voltage					
High Level			1390	mV	
Low Level	1000			mV	
Differential		300		mV	
Offset		1200		mV	
Output Current			17	mA	Drivers are shorted to ground, there is no internal termination available, an off-chip 100 Ω termination is required
Clock Signal Duty Cycle	45	50	55	%	500 MHz
Output Rise and Fall Time		0.371		ns	300 mV p-p swing
DIGITAL SPECIFICATIONS (ANALOG GPIO SIGNALS)					
Logic Inputs					
Input Voltage					
High Level	$V_{DDA_1P8} \times 0.65$		$V_{DDA_1P8} + 0.18$	V	
Low Level	-0.30		$V_{DDA_1P8} \times 0.35$	V	
Logic Outputs					
Output Voltage					
High Level	$V_{DDA_1P8} - 0.45$			V	
Low Level			0.45	V	
Drive Capability		10		mA	

¹ V_{DDA_1P8} refers to all analog 1.8 V supplies including V_{CONV_1P8} , V_{AGPIO_1P8} , V_{ANA2_1P8} , and V_{ANA1_1P8} .

POWER SUPPLY SPECIFICATIONS

Table 5.

Parameter	Min	Typ	Max	Unit
SUPPLY CHARACTERISTICS				
V_{DDA_1P0} ¹ Analog Supplies	0.975	1.0	1.025	V
V_{DD_1P0} ² Digital Supply	0.95	1.0	1.05	V

SPECIFICATIONS

Table 5.

Parameter	Min	Typ	Max	Unit
VDDA_1P3 ³ Analog Supplies	1.267	1.3	1.33	V
VDDA_1P8 Analog Supplies	1.71	1.8	1.89	V
VDD_1P8 ⁴ Digital Supply	1.71	1.8	1.89	V

¹ VDDA_1P0 refers to all analog 1.0 V supplies that operate with the internal low dropout (LDO) regulator bypassed. The power domain that allows the internal LDO regulator bypass includes VRFL02_1P0, VRFL01_1P0, VRX2LO_1P3, VRX1LO_1P3, VTX2LO_1P3, VCONV_1P3, and VTX1LO_1P3.

² VDD_1P0 refers to all digital 1.0 V supplies including VDIG_1P0.

³ VDDA_1P3 refers to all analog 1.3 V supplies including VRFVCO2_1P3, VRFVCO1_1P3, VANA2_1P3, VANA1_1P3, VRX2LO_1P3, VCLKSYN_1P3, VRFSYN2_1P3, VRFSYN1_1P3, VAUXSYN_1P3, VRX1LO_1P3, VTX2LO_1P3, VCLKVCO_1P3, VAUXVCO_1P3, VTX1LO_1P3, and VCONV_1P3.

⁴ VDD_1P8 refers to all digital 1.8 V supplies including VDIGIO_1P8.

CURRENT CONSUMPTION ESTIMATES (TYPICAL VALUES)

No external VDDA_1P0 1.0 V power domain is used in Table 6 to Table 11. In all following modes described, the ADRV9004 operates with internal LDO regulators used to produce an on-chip, 1.0 V analog power domain.

Sleep Mode

Table 6. Digital Mobile Radio (DMR) CMOS SSI

ADRV9004 Mode Conditions	Supply (mA)					Total Average Power (W)
	VDDA_1P0 Analog Supplies	VDD_1P0 Digital Supply	VDDA_1P3 Analog Supplies	VDDA_1P8 Analog Supplies	VDD_1P8 Digital Supply	
Receiver, Transmitter, Clock PLL, and LDO Regulator Powered Down, Internal Microprocessor Active, CMOS SSI Interface Off, DEV_CLK_OUT Off, and Auxiliary DACs Off	Not used	18.9	8.2	9.7	1.3	0.049
Receiver, Transmitter, Clock PLL, LDO Regulator, and Internal Microprocessor Powered Down, CMOS SSI Interface Off, DEV_CLK_OUT Off, and Auxiliary DACs Off	Not used	2.3	6.9	9.7	1.3	0.031

Table 7. Long-Term Evolution (LTE) Dual Transmitter and Dual Receiver LVDS SSI

ADRV9004 Mode Conditions	Supply (mA)					Total Average Power (W)
	VDDA_1P0 Analog Supplies	VDD_1P0 Digital Supply	VDDA_1P3 Analog Supplies	VDDA_1P8 Analog Supplies	VDD_1P8 Digital Supply	
Receiver, Transmitter, Clock PLL, and LDO Regulator Powered Down, Internal Microprocessor Active, LVDS SSI Interface Off, DEV_CLK_OUT Off, and Auxiliary DACs Off	Not used	24.6	12.4	11.3	1.3	0.066
Receiver, Transmitter, Clock PLL, LDO Regulator, and Internal Microprocessor Powered Down, LVDS SSI Interface Off, DEV_CLK_OUT Off, and Auxiliary DACs Off	Not used	2.3	10.3	10.6	1.3	0.037

SPECIFICATIONS

TDD Operation

Table 8. DMR, 4× External LO, LO = 470 MHz, Low Power Mode Clock PLL, Processor Clock Divisor = 4, CMOS SSI

ADRV9004 Mode Conditions	Supply (mA)					Total Average Power (W)
	VDDA_1P0 Analog Supplies	VDD_1P0 Digital Supply	VDDA_1P3 Analog Supplies	VDDA_1P8 Analog Supplies	VDD_1P8 Digital Supply	
1 × Receiver Low Power ADC, Low IF, 12.5 kHz Receiver Bandwidth, 24 kSPS Data Rate, Receiver QEC Enabled, QEC Engine Active, and Transmitter Powered Down	Not used	92	171	26	3	0.367
1 × Transmitter RF Attenuation = 0 dB, Full-Scale Continuous Wave 12.5 kHz Transmitter Bandwidth, 96 kSPS Data Rate, Direct Modulation (DM) Mode, Transmitter QEC Disabled, QEC Engine Inactive, and Receiver Powered Down	Not used	62	257	100	3	0.582
1 × Transmitter RF Attenuation = 6 dB, Full-Scale Continuous Wave 12.5 kHz Transmitter Bandwidth, 96 kSPS Data Rate, DM Mode, Transmitter QEC Disabled, QEC Engine Inactive, and Receiver Powered Down	Not used	62	257	58	3	0.506

Table 9. LTE40 Two Transmitters and Two Receivers (2T2R), LO = 2.5 GHz, High Performance Clock PLL, LVDS SSI

ADRV9004 Mode Conditions	Supply (mA)					Total Average Power (W)
	VDDA_1P0 Analog Supplies	VDD_1P0 Digital Supply	VDDA_1P3 Analog Supplies	VDDA_1P8 Analog Supplies	VDD_1P8 Digital Supply	
2 × Receiver Low Power ADC Low Rate, 40 MHz Receiver Bandwidth, 61.44 MSPS Data Rate, Receiver QEC Enabled, QEC Engine Active, and Transmitter in Primed State	Not used	446	546	64	53	1.366
2 × Transmitter RF Attenuation = 0 dB, Full-Scale Continuous Wave 40 MHz Transmitter Bandwidth, 61.44 MSPS Data Rate, Transmitter QEC Disabled, QEC Engine Inactive, and Receiver in Primed State	Not used	225	701	276	52	1.727
2 × Transmitter RF Attenuation = 10 dB, Full-Scale Continuous Wave 40 MHz Transmitter Bandwidth, 61.44 MSPS Data Rate, Transmitter QEC Disabled, QEC Engine Inactive, and Receiver in Primed State	Not used	225	701	120	52	1.446
2 × Transmitter RF Attenuation = 0 dB, Full-Scale Continuous Wave 40 MHz Transmitter Bandwidth, 61.44 MSPS Data Rate, Transmitter QEC Disabled, QEC Engine Active, Receiver in Primed State, Transmitter QEC Tracking Always On, Observation Receiver Continuously On, and Transmitter Tracking Duty Cycled (Practical Scenario)	Not used	397	1136	296	52	2.500
2 × Transmitter RF Attenuation = 10 dB, Full-Scale Continuous Wave 40 MHz Transmitter Bandwidth, 61.44 MSPS Data Rate, Transmitter QEC Enabled, QEC Engine Active, Receiver in Primed State, Transmitter QEC Tracking Always On, Observation Receiver Continuously On, and Transmitter Tracking Duty Cycled (Practical Scenario)	Not used	395	1126	144	52	2.212

Table 10. LTE40 One Transmitter and One Receiver (1T1R), LO = 2.5 GHz, High Performance Clock PLL, LVDS SSI

ADRV9004 Mode Conditions	Supply (mA)					Total Average Power (W)
	VDDA_1P0 Analog Supplies	VDD_1P0 Digital Supply	VDDA_1P3 Analog Supplies	VDDA_1P8 Analog Supplies	VDD_1P8 Digital Supply	
1 × Receiver Low Power ADC Low Rate, 40 MHz Receiver Bandwidth, 61.44 MSPS Data Rate, Receiver QEC Enabled, QEC Engine Active, and Transmitter in Primed State	Not used	258	406	39	28	0.906

SPECIFICATIONS

Table 10. LTE40 One Transmitter and One Receiver (1T1R), LO = 2.5 GHz, High Performance Clock PLL, LVDS SSI

ADRV9004 Mode Conditions	Supply (mA)					Total Average Power (W)
	VDDA_1P0 Analog Supplies	VDD_1P0 Digital Supply	VDDA_1P3 Analog Supplies	VDDA_1P8 Analog Supplies	VDD_1P8 Digital Supply	
1 × Transmitter RF Attenuation = 0 dB, Full-Scale Continuous Wave 40 MHz Transmitter Bandwidth, 61.44 MSPS Data Rate, Transmitter QEC Disabled, QEC Engine Inactive, and Receiver in Primed State	Not used	140	486	143	28	1.080
1 × Transmitter RF Attenuation = 10 dB, Full-Scale Continuous Wave 40 MHz Transmitter Bandwidth, 61.44 MSPS Data Rate, Transmitter QEC Disabled, QEC Engine Inactive, and Receiver in Primed State	Not used	141	486	66	28	0.942
1 × Transmitter RF Attenuation = 0 dB, Full-Scale Continuous Wave 40 MHz Transmitter Bandwidth, 61.44 MSPS Data Rate, Transmitter QEC Enabled, QEC Engine Active, Receiver in Primed State, Transmitter QEC Tracking Always On, Observation Receiver Continuously On, and Transmitter Tracking is Duty Cycled (Practical Scenario)	Not used	232	754	156	28	1.543
1 × Transmitter RF Attenuation = 10 dB, Full-Scale Continuous Wave 40 MHz Transmitter Bandwidth, 61.44 MSPS Data Rate, Transmitter QEC Enabled, QEC Engine Active, Receiver in Primed State, Transmitter QEC Tracking Always On, Observation Receiver Continuously On, and Transmitter Tracking is Duty Cycled (Practical Scenario)	Not used	231	755	79	28	1.405

FDD Operation

Transmit channel enabled, 40 MHz transmitter bandwidth, 61.44 MSPS data rate, transmitter internal LO = 2.4 GHz, transmit QEC disabled, QEC engine inactive, LVDS SSI. Receive channel enabled, 40 MHz receiver bandwidth, 61.44 MSPS data rate, receiver internal LO = 2.5 GHz, high performance clock PLL, high performance receiver ADC low rate, receive QEC enabled, and QEC engine active. Using a low power ADC decreases power consumption by approximately 110 mW per receiver channel. No auxiliary DACs or auxiliary ADCs are enabled.

Table 11. FDD Modes

ADRV9004 Mode Conditions	Supply (mA)					Total Average Power (W)
	VDDA_1P0 Analog Supplies	VDD_1P0 Digital Supply	VDDA_1P3 Analog Supplies	VDDA_1P8 Analog Supplies	VDD_1P8 Digital Supply	
1 × Receiver, 1 × Transmitter RF Attenuation = 0 dB, Full-Scale Continuous Wave	Not used	298	835	179	28	1.756
1 × Receiver, 1 × Transmitter RF Attenuation = 10 dB, Full-Scale Continuous Wave	Not used	298	835	103	28	1.619
2 × Receiver, 2 × Transmitter RF Attenuation = 0 dB, Full-Scale Continuous Wave	Not used	507	1234	344	53	2.826
2 × Receiver, 2 × Transmitter RF Attenuation = 10 dB, Full-Scale Continuous Wave	Not used	507	1234	190	53	2.549

TIMING SPECIFICATIONS

Table 12.

Parameter	Min	Typ	Max	Unit	Test Conditions/Comments
SERIAL PERIPHERAL INTERFACE (SPI) TIMING					
t _{CP}	28			ns	SPI_CLK period, 3-wire mode
	22			ns	SPI_CLK period, 4-wire mode
t _{MP}	10			ns	SPI_CLK pulse width
t _{SC}	3			ns	SPI_EN setup to first SPI_CLK rising edge

SPECIFICATIONS

Table 12.

Parameter	Min	Typ	Max	Unit	Test Conditions/Comments
t_{HC}	0			ns	Last SPI_CLK falling edge to SPI_EN hold
t_S	2			ns	SPI_DIO data input setup to SPI_CLK
t_H	0			ns	SPI_DIO data input hold to SPI_CLK
t_{CO}	3		15	ns	SPI_CLK falling edge to output data delay (3-wire mode)
	3		10	ns	SPI_CLK falling edge to output data delay (4-wire mode)
t_{HZM}		t_H	t_{CO}	ns	Bus turnaround time after the baseband processor drives the last address bit
t_{HZS}	0		t_{CO}	ns	Bus turnaround time after the ADRV9004 drives the last address bit, not shown in Figure 2
DIGITAL TIMING ¹					
TX1_ENABLE or TX2_ENABLE Pulse Width	10			μ s	
RX1_ENABLE or RX2_ENABLE Pulse Width	10			μ s	
TX1_ENABLE or TX2_ENABLE Valid Data		2		μ s	
RX1_ENABLE or RX2_ENABLE Valid Data		2		μ s	
DIGITAL DATA TIMING (LVDS SSI)					
TXx_DCLK_IN \pm , RXx_DCLK_OUT \pm and TXx_DCLK_OUT \pm Clock Period	2			ns	Zero on-chip lane skew and an adjustable delay of ± 300 ps available per lane 500 MHz
TXx_DCLK_IN \pm , RXx_DCLK_OUT \pm and TXx_DCLK_OUT \pm Pulse Width	1			ns	
Transmitter Data					
TXx_IDATA_IN \pm or TXx_QDATA_IN or TXx_STROBE_IN \pm Setup to TXx_DCLK_IN \pm	0.22			ns	
TXx_IDATA_IN \pm or TXx_QDATA_IN \pm or TXx_STROBE_IN \pm Hold to TXx_DCLK_IN \pm	0.39			ns	
Receiver Data					
RXx_DCLK_OUT \pm to RXx_IDATA_OUT \pm or RXx_QDATA_OUT \pm or RXx_STROBE_OUT \pm Delay			0.2	ns	DC-coupled
DIGITAL DATA TIMING (CMOS-SSI)					
TXx_DCLK_IN \pm , RXx_DCLK_OUT \pm and TXx_DCLK_OUT \pm Clock Period	12.5			ns	80 MHz
TXx_DCLK_IN \pm , RXx_DCLK_OUT \pm and TXx_DCLK_OUT \pm Pulse Width	6.25			ns	
Transmitter Data					
TXx_DATA_IN \pm or TXx_STROBE_IN \pm Setup to TXx_DCLK_IN \pm	2			ns	
TXx_DATA_IN \pm or TXx_STROBE_IN \pm Hold to TXx_DCLK_IN \pm	2			ns	
Receiver Data					
RXx_DCLK_OUT \pm to RXx_DATA_OUT \pm or RXx_STROBE_OUT \pm Delay			4.5	ns	DC-coupled
MULTICHIP SYNCHRONIZATION (MCS) TIMING					
LVDS Setup			0.62	ns	
LVDS Hold			0	ns	
CMOS Setup			1	ns	
CMOS Hold			3	ns	

¹ TX1_ENABLE, TX2_ENABLE, RX1_ENABLE, and RX2_ENABLE are the channel enabling and disabling signals.

SPECIFICATIONS

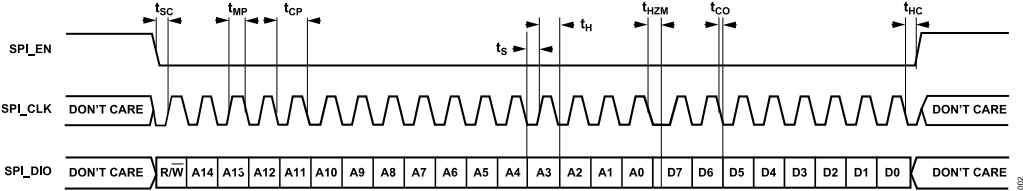

Figure 2. 3-Wire SPI Timing with Parameter Labels, SPI Read

ABSOLUTE MAXIMUM RATINGS

Table 13.

Parameter	Rating
VDDA_1P0 to VSSA	-0.2 V to +1.2 V
VDDA_1P3 to VSSA	-0.2 V to +1.5 V
VDDA_1P8 to VSSA	-0.3 V to +2.2 V
VDD_1P0 to VSSD	-0.2 V to +1.2 V
VDD_1P8 to VSSD	-0.3 V to +2.2 V
Input Current to Any Pin Except Supplies	±10 mA
Maximum Input Power into RF Ports	See Table 14 for limits vs. survival time
Junction Temperature Range	-40°C to +110°C
Storage Temperature Range	-65°C to +150°C

Stresses at or above those listed under Absolute Maximum Ratings may cause permanent damage to the product. This is a stress rating only; functional operation of the product at these or any other conditions above those indicated in the operational section of this specification is not implied. Operation beyond the maximum operating conditions for extended periods may affect product reliability.

Table 14. Maximum Input Power into RF Ports vs. Lifetime

RF Port Input Power, Continuous Wave Signal (dBm)	Lifetime	
	30 dB of Attenuation from Maximum Gain	0 dB of Attenuation from Maximum Gain
7	>10 years	>10 years
10	>10 years	20000 hours
20	>10 years	14 hours
23	>10 years	110 minutes
25	>7 years	60 minutes

REFLOW PROFILE

The ADRV9004 reflow profile is in accordance with the JEDEC JESD20 criteria for Pb-free devices. The maximum reflow temperature is 260°C.

THERMAL RESISTANCE

Thermal performance is directly linked to printed circuit board (PCB) design and operating environment. Careful attention to PCB thermal design is required.

The thermal resistance values specified in Table 15 are calculated based on JEDEC specifications (unless specified otherwise) and must be used in compliance with JESD51-12. Note that using enhanced heat removal techniques (PCB, heat sink, airflow, and so on) improves thermal resistance.

θ_{JA} is specified for the worst-case conditions, that is, a device soldered in a circuit board for surface-mount packages.

θ_{JC_TOP} is the thermal resistance from the junction to the top of the package case.

Table 15. Thermal Resistance Values^{1, 2}

Package Type	θ_{JA}	θ_{JC_TOP}	θ_{JB}	Ψ_{JC}	Ψ_{JB}	Unit
BC-196-16	18.21	0.04	3.96	0.02	3.63	°C/W

¹ For test, 100 μ m thermal interface material (TIM) is used. TIM is assumed to have 3.6 W/mK.

² Using enhanced heat removal (PCB, heat sink, airflow, and so on) techniques improve thermal resistance values.

ELECTROSTATIC DISCHARGE (ESD) RATINGS

The following ESD information is provided for handling of ESD-sensitive devices in an ESD protected area only.

Human body model (HBM) per ANSI/ESDA/JEDEC JS-001.

Charged device model (CDM) per ANSI/ESDA/JEDEC JS-002.

ESD Ratings for ADRV9004

Table 16. ADRV9004, 196-Ball CSP_BGA

ESD Model	Withstand Threshold (V)	Class
HBM	2000	2
CDM	350	C1
CDM (Excluding AUXADC_2)	500	C2A

ESD CAUTION



ESD (electrostatic discharge) sensitive device. Charged devices and circuit boards can discharge without detection. Although this product features patented or proprietary protection circuitry, damage may occur on devices subjected to high energy ESD. Therefore, proper ESD precautions should be taken to avoid performance degradation or loss of functionality.

PIN CONFIGURATION AND FUNCTION DESCRIPTIONS

	1	2	3	4	5	6	7	8	9	10	11	12	13	14
A	VSSA	VSSA	EXT_LO2+	EXT_LO2-	VRVFCO2_1P3	VRFLO2_1P0	MODEA	RBIAS	VRFLO1_1P0	VRVFCO1_1P3	EXT_LO1-	EXT_LO1+	VSSA	VSSA
B	RX2A-	VSSA	VSSA	VSSA	VSSA	VRVFCO2_1P0	AUXADC_2	AUXADC_1	VRVFCO1_1P0	VSSA	VSSA	VSSA	VSSA	RX1A-
C	RX2A+	VSSA	RX2B+	RX2B-	VSSA	VANA2_1P0	VANA2_1P3	VANA1_1P3	VANA1_1P0	VSSA	RX1B-	RX1B+	VSSA	RX1A+
D	VSSA	VSSA	VSSA	VSSA	VSSA	VSSA	MCS+	MCS-	VSSA	VSSA	VSSA	VSSA	VSSA	VSSA
E	VRX2LO_1P0	VRX2LO_1P3	AGPIO_2	VRFSYN2_1P3	VCLKSYN_1P3	VSSA	DEV_CLK_IN+	DEV_CLK_IN-	VSSA	VAUXSYN_1P3	VRFSYN1_1P3	AGPIO_0	VRX1LO_1P3	VRX1LO_1P0
F	VSSA	VSSA	VSSA	AGPIO_4	AGPIO_3	VSSA	VSSA	VSSA	VSSA	AGPIO_1	AGPIO_10	VSSA	VSSA	VSSA
G	TX2+	VSSA	VTX2LO_1P3	AGPIO_5	VCLKVCO_1P3	AGPIO_6	VCONV_1P8	VAGPIO_1P8	AGPIO_8	VAUXVCO_1P3	AGPIO_11	VTX1LO_1P3	VSSA	TX1+
H	TX2-	VANA2_1P8	VTX2LO_1P0	AUXADC_5	VCLKVCO_1P0	AGPIO_7	VCONV_1P0	VCONV_1P3	AGPIO_9	VAUXVCO_1P0	AUXADC_0	VTX1LO_1P0	VANA1_1P8	TX1-
J	VSSA	VSSA	VSSA	VSSA	VSSA	VSSA	VSSA	VSSA	VSSA	VSSA	VSSA	VSSA	VSSA	VSSA
K	SPI_CLK	SPI_DIO	RX2_EN	VSSA/TES_TCK+	VSSA/TES_TCK-	DGPIO_0	DGPIO_1	DGPIO_2	DGPIO_3	DGPIO_4	DGPIO_5	RX1_EN	RESETB	GP_INT
L	SPI_EN	SPI_DO	TX2_EN	DGPIO_6	DGPIO_7	DGPIO_8	VDIG_1P0	VDIG_1P0	DGPIO_9	DGPIO_10	DGPIO_11	TX1_EN	MODE	DEV_CLK_OUT
M	RX2_IDAT_A_OUT-	RX2_IDAT_A_OUT+	RX2_DCLK_OUT-	RX2_DCLK_OUT+	DGPIO_15/TX2_DCLK_OUT-	DGPIO_14/TX2_DCLK_OUT-	VDIGIO_1P8	VDIG_0P9	DGPIO_12/TX1_DCLK_OUT-	DGPIO_13/TX1_DCLK_OUT+	RX1_DCLK_OUT+	RX1_DCLK_OUT-	RX1_IDAT_A_OUT+	RX1_IDAT_A_OUT-
N	RX2_STROBE_OUT-	RX2_STROBE_OUT+	RX2_QDATA_OUT-	RX2_QDATA_OUT+	TX2_DCLK_IN+	TX2_DCLK_IN-	VSSD	VSSD	TX1_DCLK_IN-	TX1_DCLK_IN+	RX1_QDATA_OUT+	RX1_QDATA_OUT-	RX1_STROBE_OUT+	RX1_STROBE_OUT-
P	VSSD	TX2_STROBE_IN+	TX2_STROBE_IN-	TX2_QDATA_IN-	TX2_QDATA_IN+	TX2_IDATA_IN+	TX2_IDATA_IN-	TX1_IDATA_IN-	TX1_IDATA_IN+	TX1_QDATA_IN-	TX1_QDATA_IN+	TX1_STROBE_IN-	TX1_STROBE_IN+	VSSD

RF PORTS

ANALOG GND

DIGITAL GND

POWER 1.8V

POWER 1.3V

POWER 1.0V

DIGITAL GPIO

ANALOG GPIO

MULTIFUNCTION GPIO

SPI, ENABLES, RESET, MODE, DEV_CLK_OUT

SYNCHRONOUS SERIAL INTERFACE PORTS

AUX ADC

Figure 3. Pin Configuration

Table 17. Pin Function Descriptions

Pin No.	Type	Mnemonic	Description
A1, A2, A13, A14, B2 to B5, B10 to B13, C2, C5, C10, C13, D1 to D6, D9 to D14, E6, E9, F1 to F3, F6 to F9, F12 to F14, G2, G13, J1 to J14	Input	VSSA	Analog Ground (V _{SSA}).
A3, A4	Input	EXT_LO2+, EXT_LO2-	Differential External LO Input 1 (LO1). If EXT_LO2+ and EXT_LO2- are used for the external LO1, the input frequency must be 2x or higher than the desired carrier frequency. For an LO range from 500 MHz to 1 GHz, a 1x multiplier is available. If unused, connect EXT_LO2+ and EXT_LO2- to VSSA.
A5	Input	VRVFCO2_1P3	1.3 V Internal LDO Regulator Input Supply for RF External LO Input 2 (LO2) VCO and LO Generation Circuitry. VRVFCO2_1P3 is sensitive to supply noise.
A6	Input and Output	VRFLO2_1P0	1.0 V Internal Supply Node for RF LO2 LO Generation Circuitry. Connect VRFLO2_1P0 together with VRFVCO2_1P0 and bypass with a 4.7 μF capacitor when the internal LDO regulator operated from the VRFVCO2_1P3 input is in use. Provide a 1.0 V supply to VRFLO2_1P0 when the internal LDO regulator that is operated from VRFVCO2_1P3 is not in use.
A7	Input	MODEA	Use MODEA to configure the boot up option for the DEV_CLK_IN± inputs and the DEV_CLK_OUT output. Connect MODEA to VSSA to enable the differential clock receiver at the DEV_CLK_IN± pins. Connect MODEA to a voltage level higher than any VSSA to enable either the single-ended clock at DEV_CLK_IN+ or the crystal oscillator resonator at both of the DEV_CLK_IN± pins.

PIN CONFIGURATION AND FUNCTION DESCRIPTIONS

Table 17. Pin Function Descriptions

Pin No.	Type	Mnemonic	Description
A8	Input	RBIAS	Bias Resistor Connection. RBIAS generates an internal current based on an external 1% resistor. Connect a 4.99 kΩ resistor between RBIAS and VSSA (analog ground) .
A9	Input and Output	VRFLO1_1P0	1.0 V Internal Supply Node for RF LO1 LO Generation Circuitry. Connect VRFLO1_1P0 together with VRFVCO1_1P0 and bypass with a 4.7 μF capacitor when the internal LDO regulator operated from the VRFVCO1_1P3 input is in use. Provide a 1.0 V supply to VRFLO1_1P0 when the internal LDO regulator operated from VRFVCO1_1P3 is not in use.
A10	Input	VRFVCO1_1P3	1.3 V Internal LDO Input Supply for RF LO1 VCO and LO Generation Circuitry. VRFVCO1_1P3 is sensitive to supply noise.
A11, A12	Input	EXT_LO1-, EXT_LO1+	Differential External LO Input 2. If EXT_LO1+ and EXT_LO1- are used for the external LO2, the input frequency must be 2× or higher than the desired carrier frequency. For an LO range from 500 MHz to 1 GHz, a 1× multiplier is available. If unused, connect EXT_LO1+ and EXT_LO1- to VSSA.
B1, C1	Input	RX2A-, RX2A+	Differential Input A for Rx2. If unused, connect RX2A- and RX2A+ to VSSA.
B6	Output	VRFVCO2_1P0	1.0 V Internal Supply Node for RF LO2 VCO Circuitry. Connect this VRFVCO2_1P0 together with VRFLO2_1P0 and bypass with a 4.7 μF capacitor when the internal LDO regulator operated from the VRFVCO2_1P3 input is in use.
B7	Input	AUXADC_2	Input 2 to Auxiliary ADC Input Multiplexer. If unused, do not connect AUXADC_2.
B8	Input	AUXADC_1	Input 1 to Auxiliary ADC Input Multiplexer. If unused, do not connect AUXADC_1.
B9	Output	VRFVCO1_1P0	1.0 V Internal Supply node for RF LO1 VCO Circuitry. Connect VRFVCO1_1P0 together with VRFLO1_1P0 and bypass with a 4.7 μF capacitor when the internal LDO regulator operated from the VRFVCO1_1P3 input is in use.
B14, C14	Input	RX1A-, RX1A+	Differential Input A for Rx1. If unused, connect RX1A- and RX1A+ to VSSA.
C3, C4	Input	RX2B+, RX2B-	Differential Input B for Rx2. If unused, connect RX2B+ and RX2B- to VSSA.
C6	Input and Output	VANA2_1P0	1.0 V Internal Supply Node for Tx2 and Rx2 Baseband Circuits, TIA, Transmitter Transconductance (GM) Baseband Filters, and Auxiliary DACs and ADCs. For normal operation, leave VANA2_1P0 unconnected.
C7	Input	VANA2_1P3	1.3 V Internal LDO Input Supply for Tx2 and Rx2 Baseband Circuits, TIA, Transmitter GM, Baseband Filters, and Auxiliary DACs and ADCs. VANA2_1P3 is sensitive to supply noise.
C8	Input	VANA1_1P3	1.3 V Internal LDO Input Supply for Tx1 and Rx1 Baseband Circuits, TIA, Transmitter GM and Baseband Filters. VANA1_1P3 is sensitive to supply noise.
C9	Input and Output	VANA1_1P0	1.0 V Internal Supply Node for Tx1 and Rx1 Baseband Circuits, TIA, Transmitter GM and Baseband Filters. For normal operation, leave VANA1_1P0 unconnected.
C11, C12	Input	RX1B-, RX1B+	Differential Input B for Rx1. If unused, connect RX1B- and RX1B+ to VSSA.
D7, D8	Input	MCS+, MCS-	Multichip Synchronization Reference Inputs. If unused, connect MCS+ and MCS- to VSSA.
E1	Output	VRX2LO_1P0	1.0 V Internal Supply Node for Rx2 LO Buffers and Mixers. VRX2LO_1P0 is sensitive to supply noise. Bypass VRX2LO_1P0 with a 4.7 μF capacitor.
E2	Input	VRX2LO_1P3	1.3 V Internal LDO Input Supply for Rx2 LO Buffers and Mixers. Provide a 1.0 V supply to VRX2LO_1P3 when the internal LDO regulator is not used. VRX2LO_1P3 is sensitive to supply noise.
E3, E12, F4, F5, F10, F11, G4, G6, G9, G11, H6, H9	Input and Output	AGPIO_xx	GPIOs Signals Referenced to VAGPIO_1P8 1.8 V Supply. See Table 18 to match the ball location to the AGPIO_xx signal name. Some AGPIO_xx pins can also function as auxiliary DAC outputs. See Table 18 for mapping between AGPIO_xx and the auxiliary DAC signals. If unused, do not connect AGPIO_xx.
E4	Input	VRFSYN2_1P3	1.3 V Supply for RF LO2 Synthesizer. VRFSYN2_1P3 is sensitive to supply noise.
E5	Input	VCLKSYN_1P3	1.3 V Supply for Clock Synthesizer. VCLKSYN_1P3 is sensitive to supply noise.
E7, E8	Input	DEV_CLK_IN+, DEV_CLK_IN-	Device Clock Input. DEV_CLK_IN± can operate as differential, single-ended, or be connected to the external crystal oscillator. In single-ended mode, apply the clock signal to the DEV_CLK_IN+ pin and leave the DEV_CLK_IN- pin unconnected.
E10	Input	VAUXSYN_1P3	1.3 V Supply for Auxiliary Synthesizer. VAUXSYN_1P3 is sensitive to supply noise.
E11	Input	VRFSYN1_1P3	1.3 V Supply for RF LO1 Synthesizer. VRFSYN1_1P3 is sensitive to supply noise.
E13	Input	VRX1LO_1P3	1.3 V Internal LDO Input Supply for Rx1 LO Buffers and Mixers. Provide a 1.0 V supply to VRX1LO_1P3 when the internal LDO regulator is not used. VRX1LO_1P3 is sensitive to supply noise.
E14	Output	VRX1LO_1P0	1.0 V Internal Supply Node for Rx1 LO Buffers and Mixers. VRX1LO_1P0 is sensitive to supply noise. Bypass VRX1LO_1P0 with a 4.7 μF capacitor.
G1, H1	Output	TX2+, TX2-	Differential Output for Transmitter Channel 2. If unused, do not connect TX2+ and TX2-.

PIN CONFIGURATION AND FUNCTION DESCRIPTIONS

Table 17. Pin Function Descriptions

Pin No.	Type	Mnemonic	Description
G3	Input	VTX2LO_1P3	1.3 V Supply for Tx2 LO Buffers, Upconverter, and LO Delay. Provide a 1.0 V supply to VTX2LO_1P3 when the internal LDO is not used. VTX2LO_1P3 is sensitive to supply noise.
G5	Input	VCLKVCO_1P3	1.3 V Internal LDO Input Supply for Clock LO VCO and LO Generation Circuitry. VCLKVCO_1P3 is sensitive to supply noise.
G7	Input	VCONV_1P8	1.8 V Supply for Tx1 and Tx2 DAC and Rx1 and Rx2 ADC.
G8	Input	VAGPIO_1P8	1.8 V Supply for Auxiliary DACs, Auxiliary ADCs, and AGPIO Signals.
G10	Input	VAUXVCO_1P3	1.3 V Internal LDO Input Supply for Auxiliary LO VCO and LO Generation Circuitry. VAUXVCO_1P3 is sensitive to supply noise.
G12	Input	VTX1LO_1P3	1.3 V Internal LDO Input Supply for Tx1 LO Buffers, Upconverter, and LO Delay. Provide a 1.0 V supply to VTX1LO_1P3 when the internal LDO regulator is not used. VTX1LO_1P3 is sensitive to supply noise.
G14, H14	Output	TX1+, TX1-	Differential Output for Transmitter Channel 1. If unused, do not connect TX1+ and TX1-.
H2	Input	VANA2_1P8	1.8 V Supply for Rx2 Mixer, Rx2 TIA, Tx2 LPF, and Internal References.
H3	Output	VTX2LO_1P0	1.0 V Internal Supply Node for Tx2 LO Buffers, Upconverter, and LO Delay. For normal operation, leave VTX2LO_1P0 unconnected.
H4	Input	AUXADC_3	Input 3 to Auxiliary ADC Input Multiplexer. If unused, do not connect AUXADC_3.
H5	Output	VCLKVCO_1P0	1.0 V Internal Supply Node for Clock LO VCO and LO Generation Circuitry. Bypass VCLKVCO_1P0 with a 4.7 μ F capacitor.
H7	Output	VCONV_1P0	1.0 V Internal Supply Node for Receiver ADCs and Transmitter DACs. Bypass VCONV_1P0 with a 4.7 μ F capacitor.
H8	Input	VCONV_1P3	1.3 V Internal LDO Input Supply for Receiver ADCs and Transmitter DACs. Provide a 1.0 V supply to VCONV_1P3 when the internal LDO regulator is not used. VCONV_1P3 is sensitive to supply noise.
H10	Output	VAUXVCO_1P0	1.0 V Internal Supply Node for Auxiliary LO VCO and LO Generation Circuitry. Bypass VAUXVCO_1P0 with a 4.7 μ F Capacitor.
H11	Input	AUXADC_0	Input 0 to Auxiliary ADC Input Multiplexer. If unused, do not connect AUXADC_0.
H12	Output	VTX1LO_1P0	1.0 V Internal Supply Node for Tx1 LO Buffers, Upconverter, and LO Delay. For normal operation, leave VTX1LO_1P0 unconnected.
H13	Input	VANA1_1P8	1.8 V Supply for Rx1 Mixer, Rx1 TIA, Tx1 LPF, Crystal Oscillator, DEV_CLK Circuitry, and Internal References.
K1	Input	SPI_CLK	Serial Data Bus Clock Input.
K2	Input and Output	SPI_DIO	Serial Data Input in 4-Wire Mode or Input and Output in 3-Wire Mode.
K3	Input	RX2_EN	Enable Input for Rx2. If unused, do not connect RX2_EN.
K4	Input	VSSA/TESTCK+	Connect VSSA/TESTCK+ to VSSA for normal operation.
K5	Input	VSSA/TESTCK-	Connect VSSA/TESTCK- to VSSA for normal operation.
K6 to K11, L4 to L6, L9 to L11	Input and Output	DGPIO_xx	Digital GPIO. VDIGO_1P8 supplies 1.8 V to DGPIO_xx. See Table 18 to match the pin location to the DGPIO_xx signal name. If unused, do not connect DGPIO_xx.
K12	Input	RX1_EN	Enable Input for Rx1. If unused, do not connect RX1_EN.
K13	Input	RESETB	Active Low Chip Reset.
K14	Output	GP_INT	General-Purpose Digital Interrupt Output Signal. If unused, do not connect GP_INT.
L1	Input	SPI_EN	Active Low Serial Data Bus Chip Select.
L2	Output	SPI_DO	Serial Data Output. If unused in SPI 3-wire mode, do not connect SPI_DO.
L3	Input	TX2_EN	Enable Input for Transmitter Channel 2. If unused, do not connect TX2_EN.
L7, L8	Input	VDIG_1P0	1.0 V Digital Core. Connect Pin L7 and Pin L8 together. Use a wide trace to connect the VDIG_1P0 pins to a separate power supply domain. Provide reservoir capacitance close to the chip.
L12	Input	TX1_EN	Enable Input for Transmitter Channel 1. If unused, do not connect TX1_EN.
L13	Input	MODE	Joint Test Action Group (JTAG) Boundary Scan Pin. See Table 19 for more information. If unused, connect MODE to VSSA.
L14	Output	DEV_CLK_OUT	Single-Ended Device Clock Output. DEV_CLK_OUT provides a DEV_CLK signal or the divided version to the baseband IC. If unused, do not connect DEV_CLK_OUT.

PIN CONFIGURATION AND FUNCTION DESCRIPTIONS

Table 17. Pin Function Descriptions

Pin No.	Type	Mnemonic	Description
M1	Output	RX2_IDATA_OUT-	In LVDS SSI mode, RX2_IDATA_OUT- is the Rx2 I sample data output on the negative side or the Rx2 I and Q sample data output on the negative side. In CMOS SSI mode, RX2_IDATA_OUT- is the Rx2 Data Output 0 or the Rx2 I and Q sample data output. If unused, do not connect RX2_IDATA_OUT-.
M2	Output	RX2_IDATA_OUT+	In LVDS SSI mode, RX2_IDATA_OUT+ is the Rx2 I sample data output positive side of the differential pair or the Rx2 I and Q sample data output positive side of the differential pair. In CMOS SSI mode, RX2_IDATA_OUT+ is the Rx2 Data Output 1. If unused, do not connect RX2_IDATA_OUT+.
M3	Output	RX2_DCLK_OUT-	In LVDS SSI mode, RX2_DCLK_OUT- is the Rx2 data clock output negative side. In CMOS SSI mode, RX2_DCLK_OUT- is not used. If unused, do not connect RX2_DCLK_OUT-.
M4	Output	RX2_DCLK_OUT+	In LVDS SSI mode, RX2_DCLK_OUT+ is the Rx2 data clock output positive side. In CMOS SSI mode, RX2_DCLK_OUT+ is the Rx2 data clock output. If unused, do not connect RX2_DCLK_OUT+.
M5	Input and Output	DGPIO_15/TX2_DCLK_OUT+	Digital GPIO 15. VDIGIO_1P8 supplies 1.8 V to DGPIO_15/TX2_DCLK_OUT+. Alternative function of DGPIO_15/TX2_DCLK_OUT+ is to provide the positive side of the reference clock output for the Tx2 data port in LVDS SSI mode. If unused, do not connect DGPIO_15/TX2_DCLK_OUT+.
M6	Input and Output	DGPIO_14/TX2_DCLK_OUT-	Digital GPIO 14. VDIGIO_1P8 supplies 1.8 V to DGPIO_14/TX2_DCLK_OUT-. The alternative function of DGPIO_14/TX2_DCLK_OUT- is to provide the negative side of the reference clock output for the Tx2 data port in LVDS SSI mode. If unused, do not connect DGPIO_14/TX2_DCLK_OUT-.
M7	Input	VDIGIO_1P8	1.8 V Supply Input for Data Port Interface (CMOS-SSI and LVDS SSI Mode), SPI Signals, Control Input and Output Signals, and DGPIO Interface.
M8	Output	VDIG_0P9	1.0 V Internal Supply Node for Digital Circuitry. Bypass VDIG_0P9 with a 4.7 μ F capacitor.
M9	Input and Output	DGPIO_12/TX1_DCLK_OUT-	Digital GPIO 12. VDIGIO_1P8 supplies 1.8 V to DGPIO_12/TX1_DCLK_OUT-. The alternative function of DGPIO_12/TX1_DCLK_OUT- is to provide the negative side of the reference clock output for the Tx1 data port in LVDS SSI mode. If unused, do not connect DGPIO_12/TX1_DCLK_OUT-.
M10	Input and Output	DGPIO_13/TX1_DCLK_OUT+	Digital GPIO 13. VDIGIO_1P8 supplies 1.8 V to DGPIO_13/TX1_DCLK_OUT+. The alternative function of DGPIO_13/TX1_DCLK_OUT+ is to provide the positive side of the reference clock output for the Tx1 data port in LVDS SSI mode. If unused, do not connect DGPIO_13/TX1_DCLK_OUT+.
M11	Output	RX1_DCLK_OUT+	In LVDS SSI mode, RX1_DCLK_OUT+ is the Rx1 data clock output positive side. In CMOS SSI mode, RX1_DCLK_OUT+ is the Rx1 data clock output. If unused, do not connect RX1_DCLK_OUT+.
M12	Output	RX1_DCLK_OUT-	In LVDS SSI mode, RX1_DCLK_OUT- is the Rx1 data clock output negative side. In CMOS SSI mode, RX1_DCLK_OUT- is not used. If unused, do not connect RX1_DCLK_OUT-.
M13	Output	RX1_IDATA_OUT+	In LVDS SSI mode, RX1_IDATA_OUT+ is the Rx1 I sample data output positive side or the Rx1 I and Q sample data output positive side. In CMOS SSI mode, RX1_IDATA_OUT+ is the Rx1 Data Output 1.
M14	Output	RX1_IDATA_OUT-	In LVDS SSI mode, RX1_IDATA_OUT- is the Rx1 I sample data output negative side or the Rx1 I and Q sample data output negative side. In CMOS SSI mode, RX1_IDATA_OUT- is the Rx1 Data Output 0 or the Rx1 I and Q sample data output.
N1	Output	RX2_STROBE_OUT-	In LVDS SSI mode, RX2_STROBE_OUT- is the Rx2 strobe output negative side. In CMOS SSI mode, RX2_STROBE_OUT- is not used. If unused, do not connect RX2_STROBE_OUT-.
N2	Output	RX2_STROBE_OUT+	In LVDS SSI mode, RX2_STROBE_OUT+ is the Rx2 strobe output positive side. In CMOS SSI mode, RX2_STROBE_OUT+ is the Rx2 strobe output. If unused, do not connect RX2_STROBE_OUT+.
N3	Output	RX2_QDATA_OUT-	In LVDS SSI mode, RX2_QDATA_OUT- is the Rx2 Q sample data output positive side. In CMOS SSI mode, RX2_QDATA_OUT- is the Rx2 Data Output 2. If unused, do not connect RX2_QDATA_OUT-.
N4	Output	RX2_QDATA_OUT+	In LVDS SSI mode, RX2_QDATA_OUT+ is the Rx2 Q sample data output positive side. In CMOS SSI mode, RX2_QDATA_OUT+ is the Rx2 Data Output 3. If unused, do not connect RX2_QDATA_OUT+.
N5	Input	TX2_DCLK_IN+	In LVDS SSI mode, TX2_DCLK_IN+ is the Tx2 data clock input positive side. In CMOS SSI mode, TX2_DCLK_IN+ is the Tx2 data clock input. If unused, do not connect TX2_DCLK_IN+.
N6	Input	TX2_DCLK_IN-	In LVDS SSI mode, TX2_DCLK_IN- is the Tx2 data clock input negative side. In CMOS SSI mode, TX2_DCLK_IN- is not used. If unused, do not connect TX2_DCLK_IN-.
N7, N8, P1, P14	Input	VSSD	Digital Supply Voltage (V_{SSD}).
N9	Input	TX1_DCLK_IN-	In LVDS SSI mode, TX1_DCLK_IN- is the Tx1 data clock input negative side. In CMOS SSI mode, TX1_DCLK_IN- is not used. If unused, do not connect TX1_DCLK_IN-.
N10	Input	TX1_DCLK_IN+	In LVDS SSI mode, TX1_DCLK_IN+ is the Tx1 data clock input positive side. In CMOS SSI mode, TX1_DCLK_IN+ is the Tx1 data clock input. If unused, do not connect TX1_DCLK_IN+.
N11	Output	RX1_QDATA_OUT+	In LVDS SSI mode, RX1_QDATA_OUT+ is the Rx1 Q sample data output positive side. In CMOS SSI mode, RX1_QDATA_OUT+ is the Rx1 Data Output 3. If unused, do not connect RX1_QDATA_OUT+.

PIN CONFIGURATION AND FUNCTION DESCRIPTIONS

Table 17. Pin Function Descriptions

Pin No.	Type	Mnemonic	Description
N12	Output	RX1_QDATA_OUT-	In LVDS SSI mode, RX1_QDATA_OUT- is the Rx1 Q sample data output positive side. In CMOS SSI mode, RX1_QDATA_OUT- is the Rx1 Data Output 2. If unused, do not connect RX1_QDATA_OUT-.
N13	Output	RX1_STROBE_OUT+	In LVDS SSI mode, RX1_STROBE_OUT+ is the Rx1 strobe output positive side. In CMOS SSI mode, RX1_STROBE_OUT+ is the Rx1 strobe output. If unused, do not connect RX1_STROBE_OUT+.
N14	Output	RX1_STROBE_OUT-	In LVDS SSI mode, RX1_STROBE_OUT- is the Rx1 strobe output negative side. In CMOS SSI mode, RX1_STROBE_OUT- is not used. If unused, do not connect RX1_STROBE_OUT-.
P2	Input	TX2_STROBE_IN+	In LVDS SSI mode, TX2_STROBE_IN+ is the Tx2 strobe input positive side. In CMOS SSI mode, TX2_STROBE_IN+ is the Tx2 strobe input. If unused, do not connect TX2_STROBE_IN+.
P3	Input and Output	TX2_STROBE_IN-	In LVDS SSI mode, TX2_STROBE_IN- is the Tx2 strobe input negative side. In CMOS SSI mode, TX2_STROBE_IN- is the Tx2 reference data clock output. If unused, do not connect TX2_STROBE_IN-.
P4	Input	TX2_QDATA_IN-	In LVDS SSI mode, TX2_QDATA_IN- is the Tx2 Q sample data input negative side. In CMOS SSI mode, TX2_QDATA_IN- is the Tx2 Data Input 2. If unused, do not connect TX2_QDATA_IN-.
P5	Input	TX2_QDATA_IN+	In LVDS SSI mode, TX2_QDATA_IN+ is the Tx2 Q sample data input positive side. In CMOS SSI mode, TX2_QDATA_IN+ is the Tx2 Data Input 3. If unused, do not connect TX2_QDATA_IN+.
P6	Input	TX2_IDATA_IN+	In LVDS SSI mode, TX2_IDATA_IN+ is the Tx2 I sample data input positive side or the Tx2 I and Q sample data input positive side. In CMOS SSI mode, TX2_IDATA_IN+ is the Tx2 Data Input 1. If unused, do not connect TX2_IDATA_IN+.
P7	Input	TX2_IDATA_IN-	In LVDS SSI mode, TX2_IDATA_IN- is the Tx2 I sample data input negative side or the Tx2 I and Q sample data input negative side. In CMOS SSI mode, TX2_IDATA_IN- is the Tx2 Data Input 0 or the Tx2 I and Q sample data input. If unused, do not connect TX2_IDATA_IN-.
P8	Input	TX1_IDATA_IN-	In LVDS SSI mode, TX1_IDATA_IN- is the Tx1 I sample data input negative side or the Tx1 I and Q sample data input negative side. In CMOS SSI mode, TX1_IDATA_IN- is the Tx1 Data Input 0 or the Tx1 I and Q sample data input. If unused, do not connect TX1_IDATA_IN-.
P9	Input	TX1_IDATA_IN+	In LVDS SSI mode, TX1_IDATA_IN+ is the Tx1 I sample data input positive side or the Tx1 I and Q sample data input positive side. In CMOS SSI mode, TX1_IDATA_IN+ is the Tx1 Data Input 1. If unused, do not connect TX1_IDATA_IN+.
P10	Input	TX1_QDATA_IN+	In LVDS SSI mode, TX1_QDATA_IN+ is the Tx1 Q sample data input positive side. In CMOS SSI mode, TX1_QDATA_IN+ is the Tx1 Data Input 3. If unused, do not connect TX1_QDATA_IN+.
P11	Input	TX1_QDATA_IN-	In LVDS SSI mode, TX1_QDATA_IN- is the Tx1 Q sample data input negative side. In CMOS SSI mode, TX1_QDATA_IN- is the Tx1 Data Input 2. If unused, do not connect TX1_QDATA_IN-.
P12	Input and Output	TX1_STROBE_IN-	In LVDS SSI mode, TX1_STROBE_IN- is the Tx1 strobe input negative side. In CMOS SSI mode, TX1_STROBE_IN- is the Tx1 reference data clock output. If unused, do not connect TX1_STROBE_IN-.
P13	Input	TX1_STROBE_IN+	In LVDS SSI mode, TX1_STROBE_IN+ is the Tx1 strobe input positive side. In CMOS SSI mode, TX1_STROBE_IN+ is the Tx1 strobe input. If unused, do not connect TX1_STROBE_IN+.

TYPICAL PERFORMANCE CHARACTERISTICS

The ADRV9004 supports a signal bandwidth from 12 kHz to 40 MHz. The bandwidth of 1 MHz is the boundary to distinguish between narrow-band and wideband profiles. If the signal bandwidth is less than 1 MHz, it is considered a narrow-band profile. Otherwise, it is considered a wideband profile. The performance of the ADRV9004 is measured for both wideband and narrow-band profiles.

WIDEBAND

Device configuration profile: receiver = 40 MHz bandwidth, I/Q rate = 61.44 MHz, transmitter = 40 MHz bandwidth, I/Q rate = 61.44 MHz, device clock = 38.4 MHz, and an internal LO is used for all measurements. Measurements are at nominal power supply voltages. All RF specifications are based on measurements that include PCB and matching circuit losses, unless otherwise noted. Specifications are applicable over the lifetime of the device.

50 MHz LO

The temperature settings refer to the die temperature. All LO frequencies are set to 50 MHz, unless otherwise noted.

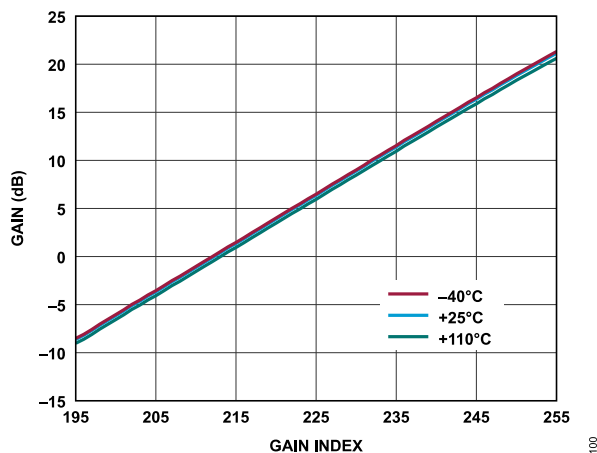

Figure 4. Receiver Absolute Gain (Complex) vs. Gain Index, Baseband Frequency = 5.6 MHz, ADC = High Performance, $P_{OUT} = -9.6$ dBFS

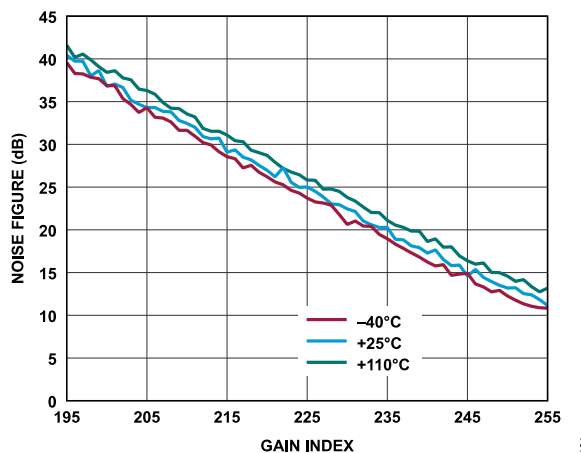

Figure 6. Receiver Noise Figure vs. Gain Index, Baseband Frequency = 5.6 MHz, ADC = High Performance

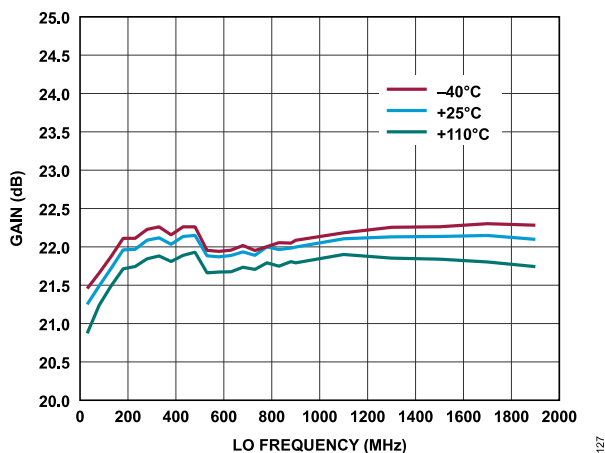

Figure 5. Receiver Absolute Gain (Complex) vs. LO Frequency, Baseband Frequency = 5.6 MHz, ADC = High Performance, $P_{OUT} = -9.6$ dBFS

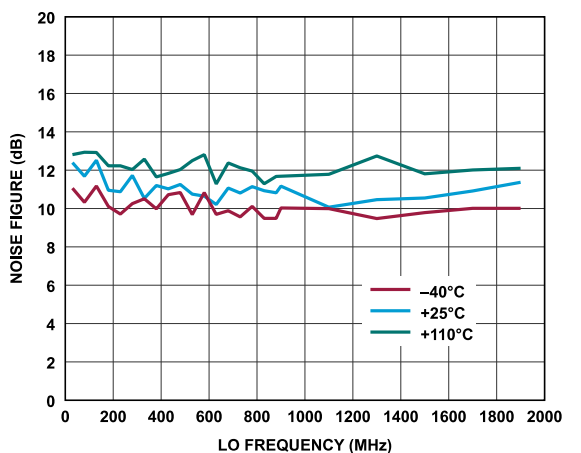

Figure 7. Receiver Noise Figure vs. LO Frequency, Baseband Frequency = 5.6 MHz, ADC = High Performance

TYPICAL PERFORMANCE CHARACTERISTICS

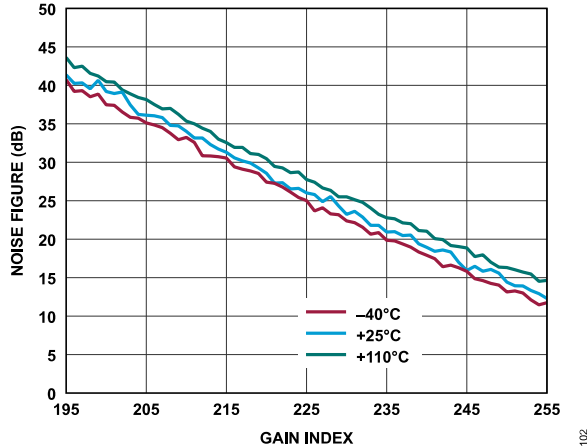

Figure 8. Receiver Noise Figure vs. Gain Index, Baseband Frequency = 5.6 MHz, ADC = Low Power

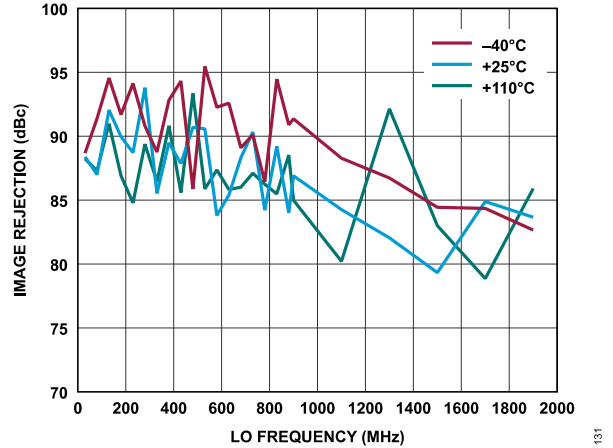

Figure 11. Receiver Image Rejection vs. LO Frequency, Baseband Frequency = 5.6 MHz, ADC = Low Power, Initialization Calibration and Hardware Tracking Calibration Only

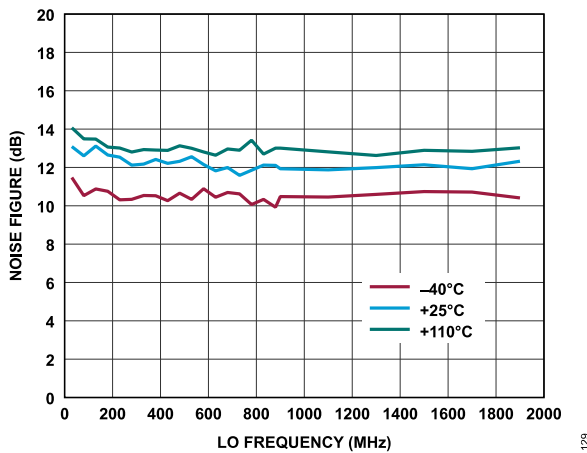

Figure 9. Receiver Noise Figure vs. LO Frequency, Baseband Frequency = 5.6 MHz, ADC = Low Power

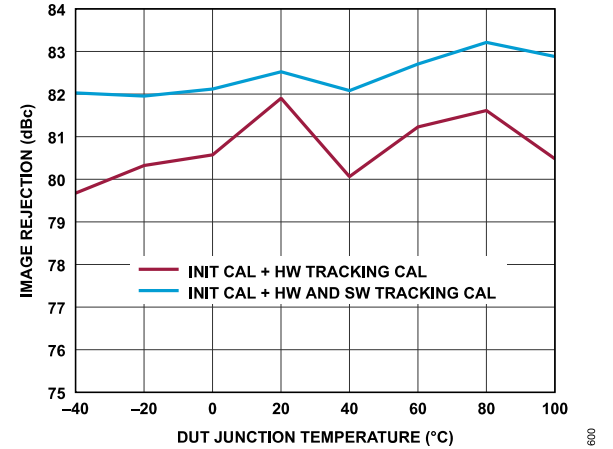

Figure 12. Receiver Image Rejection vs. DUT Junction Temperature (Low to High), Tone 1 Baseband Frequency = -5.1 MHz, Tone 2 Baseband Frequency = 13.9 MHz, ADC = High Performance, $P_{OUT} = -15.1$ dBFS

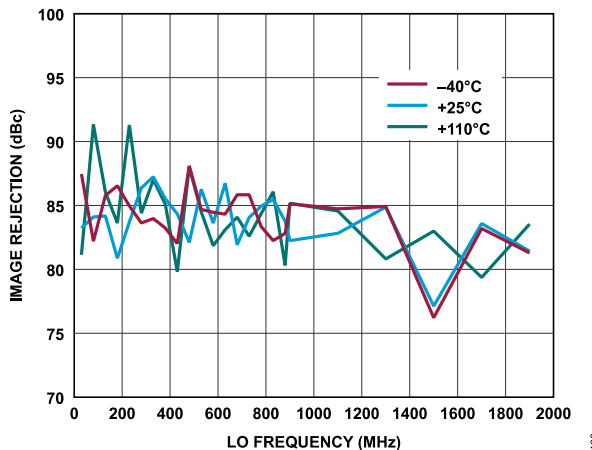

Figure 10. Receiver Image Rejection vs. LO Frequency, Baseband Frequency = 5.6 MHz, ADC = High Performance, Initialization Calibration and Hardware Tracking Calibration Only

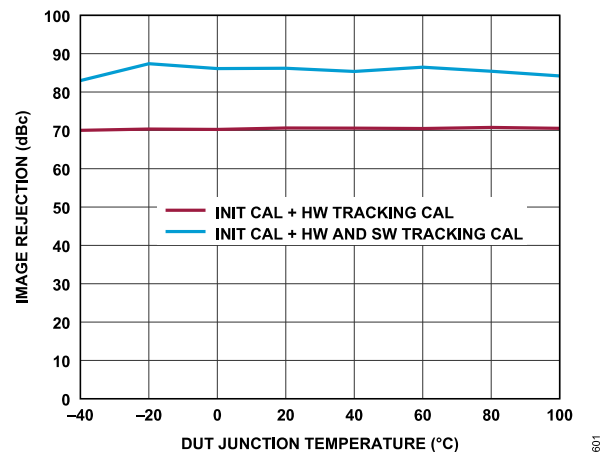

Figure 13. Receiver Image Rejection vs. DUT Junction Temperature (Low to High), Tone 1 Baseband Frequency = -5.1 MHz, Tone 2 Baseband Frequency = 13.9 MHz, ADC = Low Power, $P_{OUT} = -15.1$ dBFS

TYPICAL PERFORMANCE CHARACTERISTICS

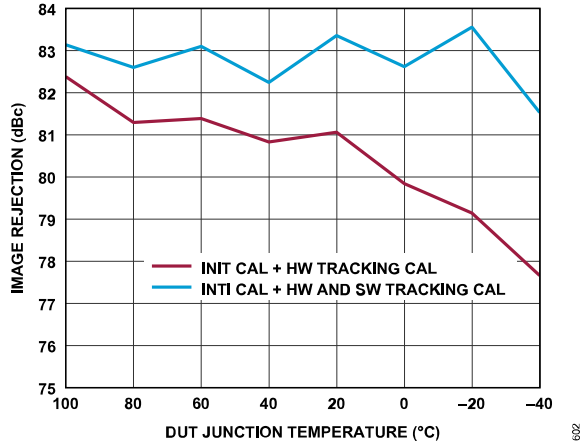

Figure 14. Receiver Image Rejection vs. DUT Junction Temperature (High to Low), Tone 1 Baseband Frequency = -5.1 MHz, Tone 2 Baseband Frequency = 13.9 MHz, ADC = High Performance, $P_{OUT} = -15.1$ dBFS

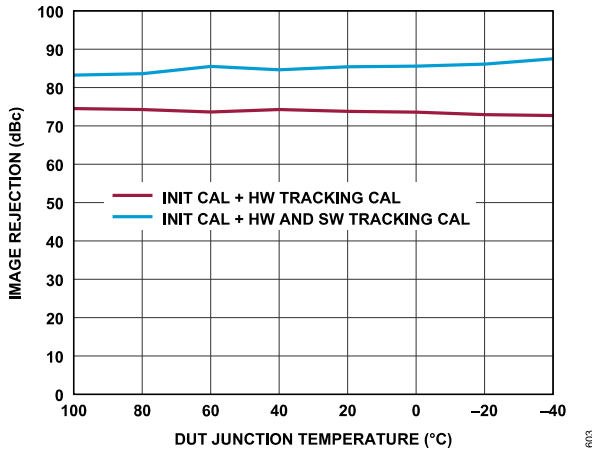

Figure 15. Receiver Image Rejection vs. DUT Junction Temperature (High to Low), Tone 1 Baseband Frequency = -5.1 MHz, Tone 2 Baseband Frequency = 13.9 MHz, ADC = Low Power, $P_{OUT} = -15.1$ dBFS

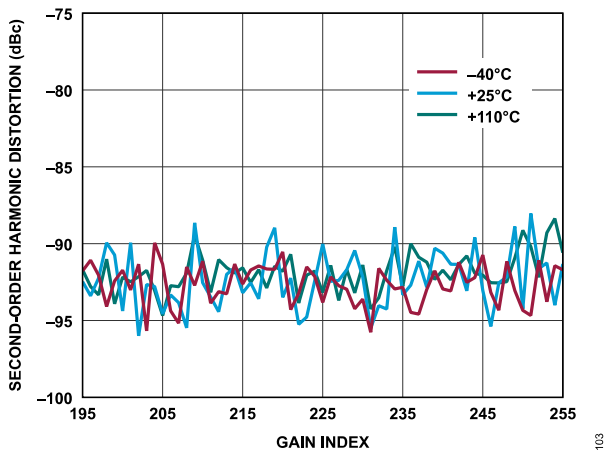

Figure 16. Receiver Second-Order Harmonic Distortion vs. Gain Index, Baseband Frequency = 5.6 MHz, ADC = High Performance

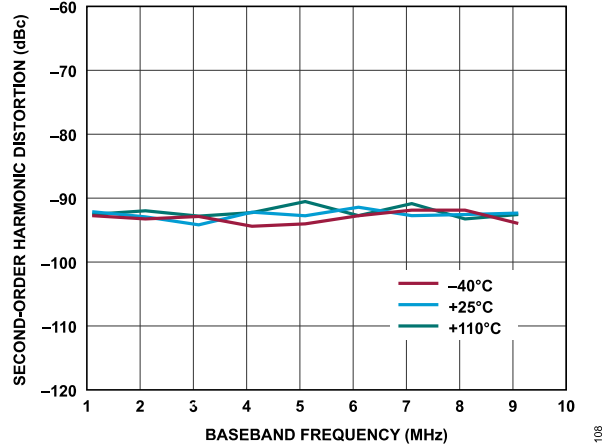

Figure 17. Receiver Second-Order Harmonic Distortion vs. Baseband Frequency, Gain Index = 255, ADC = High Performance

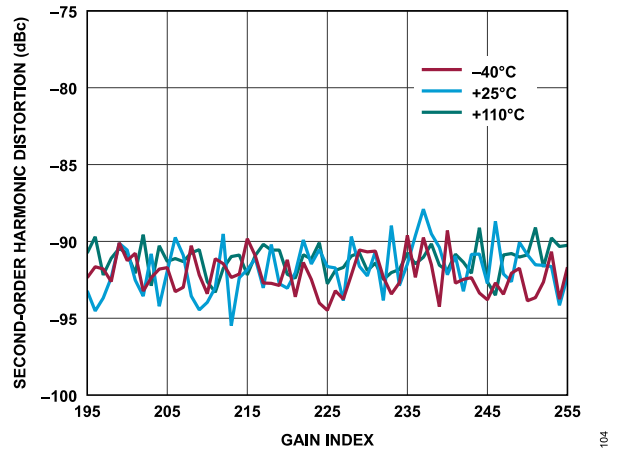

Figure 18. Receiver Second-Order Harmonic Distortion vs. Gain Index, Baseband Frequency = 5.6 MHz, ADC = Low Power

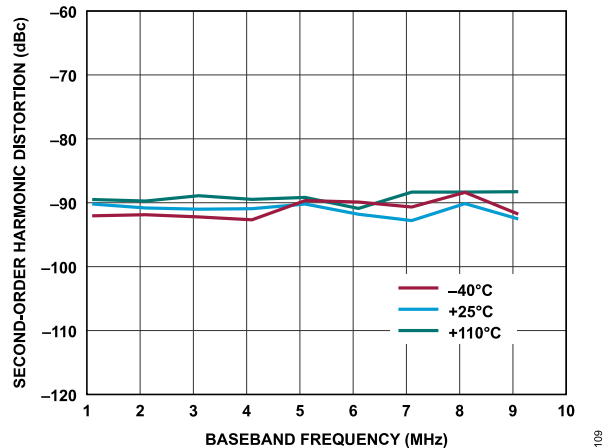

Figure 19. Receiver Second-Order Harmonic Distortion vs. Baseband Frequency, Gain Index = 255, ADC = Low Power

TYPICAL PERFORMANCE CHARACTERISTICS

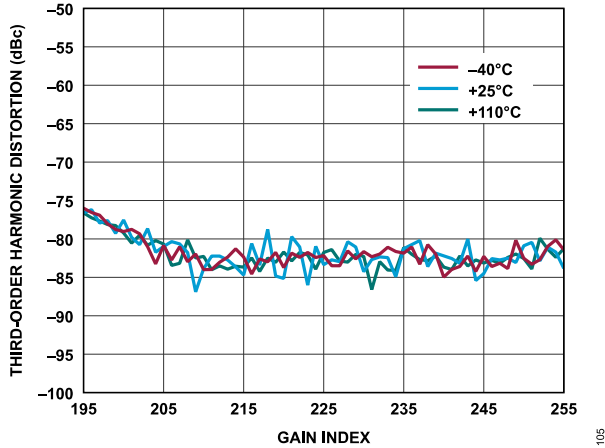

Figure 20. Receiver Third-Order Harmonic Distortion vs. Gain Index, Baseband Frequency = 5.6 MHz, ADC = High Performance

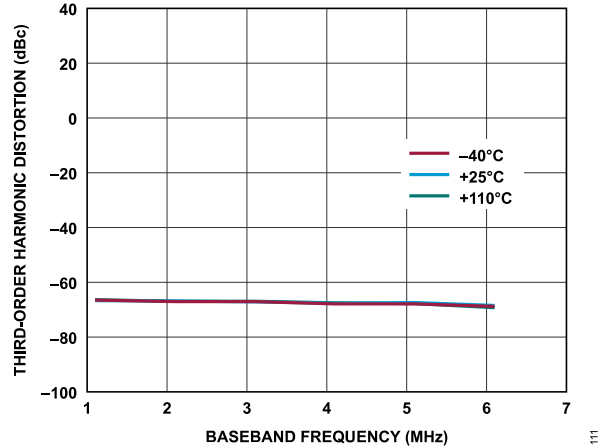

Figure 23. Receiver Third-Order Harmonic Distortion vs. Baseband Frequency, Gain Index = 255, ADC = Low Power

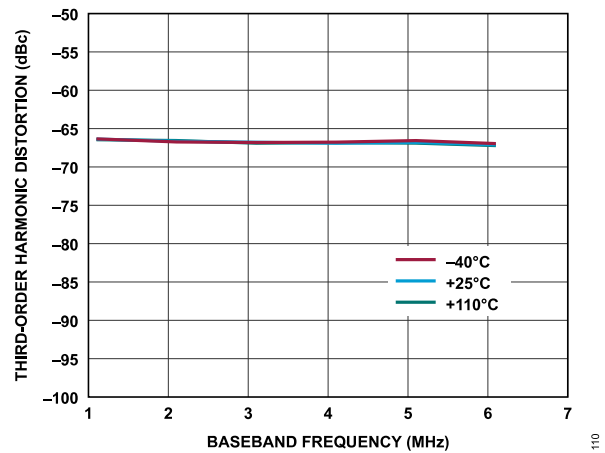

Figure 21. Receiver Third-Order Harmonic Distortion vs. Baseband Frequency, Gain Index = 255, ADC = High Performance

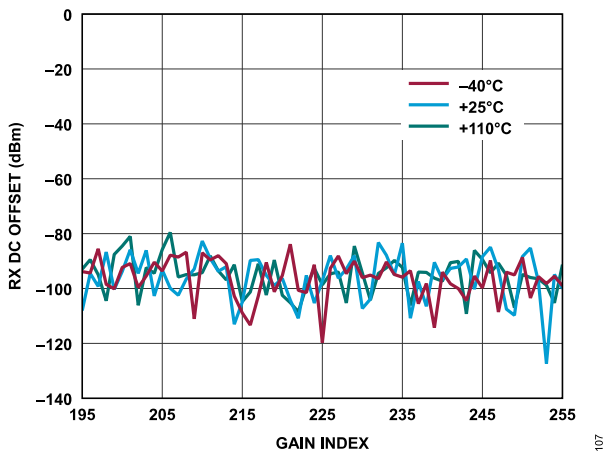

Figure 24. Receiver DC Offset vs. Gain Index, Baseband Frequency = 5.6 MHz, ADC = High Performance

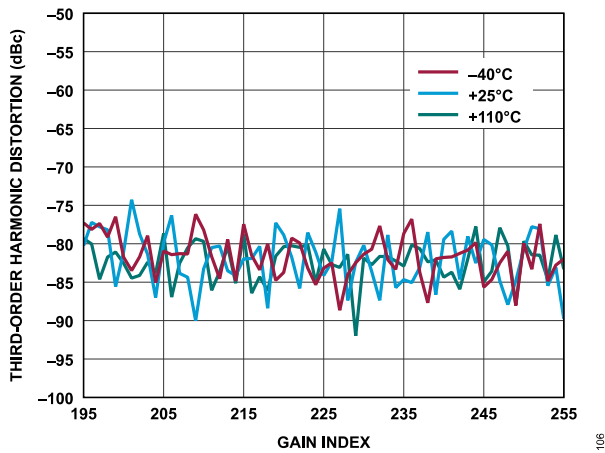

Figure 22. Receiver Third-Order Harmonic Distortion vs. Gain Index, Baseband Frequency = 5.6 MHz, ADC = Low Power

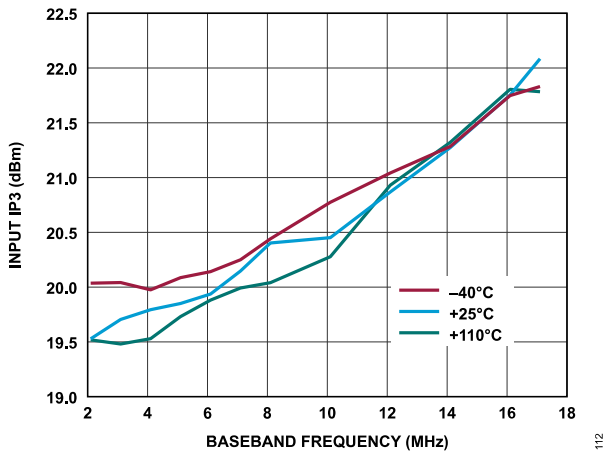

Figure 25. Receiver Input IP3 vs. Baseband Frequency, ADC = High Performance, f_1 = Baseband Frequency, f_2 = Baseband Frequency + 1 MHz, Gain Index = 255

TYPICAL PERFORMANCE CHARACTERISTICS

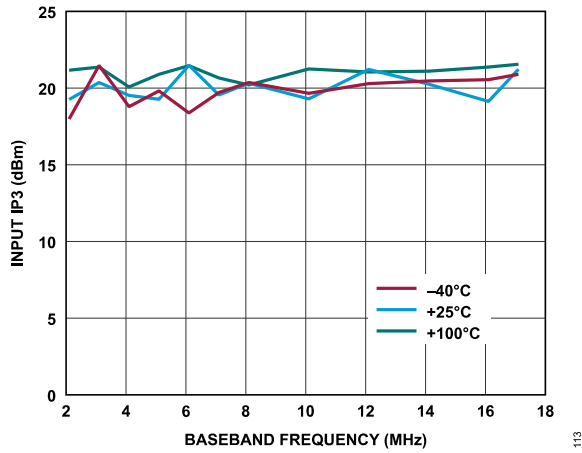

Figure 26. Receiver Input IP3 vs. Baseband Frequency, ADC = Low Power, f_1 = Baseband Frequency, f_2 = Baseband Frequency + 1 MHz, Gain Index = 255

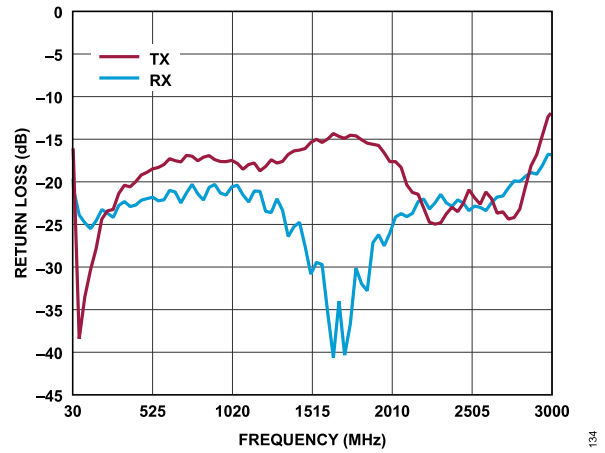

Figure 29. Receiver and Transmitter Return Loss vs. Frequency (For LO = 30 MHz to 3 GHz)

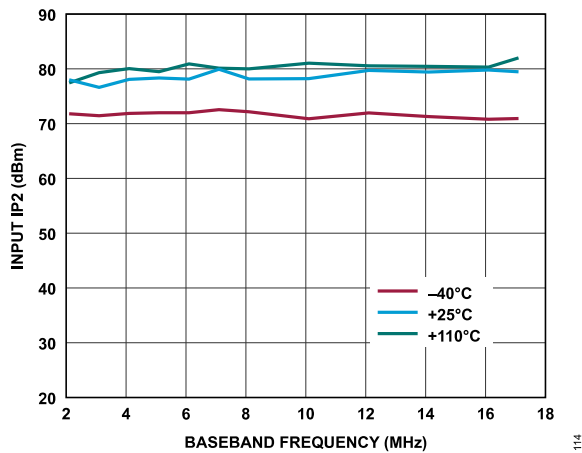

Figure 27. Receiver Input IP2 vs. Baseband Frequency, ADC = High Performance, f_1 = Baseband Frequency, f_2 = Baseband Frequency + 1 MHz, Gain Index = 255

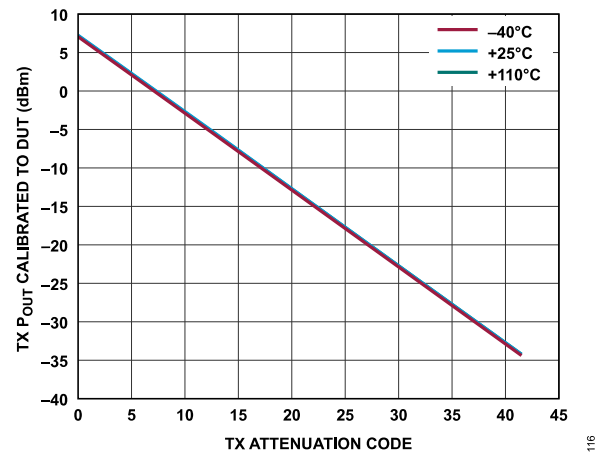

Figure 30. Transmitter Absolute Power vs. Transmitter Attenuation Code, Baseband Frequency = 18 MHz, Backoff = 0.2 dBFS

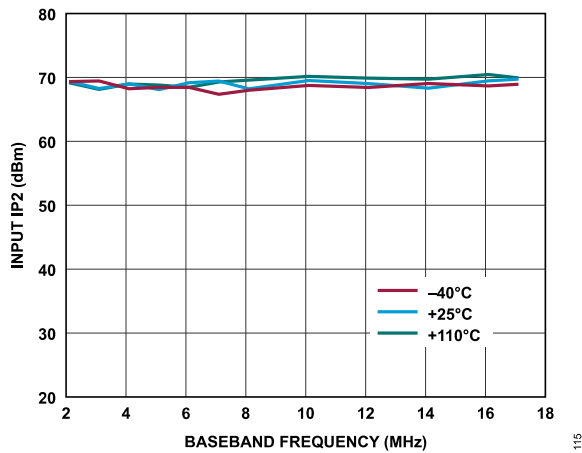

Figure 28. Receiver Input IP2 vs. Baseband Frequency, ADC = Low Power, f_1 = Baseband Frequency, f_2 = Baseband Frequency + 1 MHz, Gain Index = 255

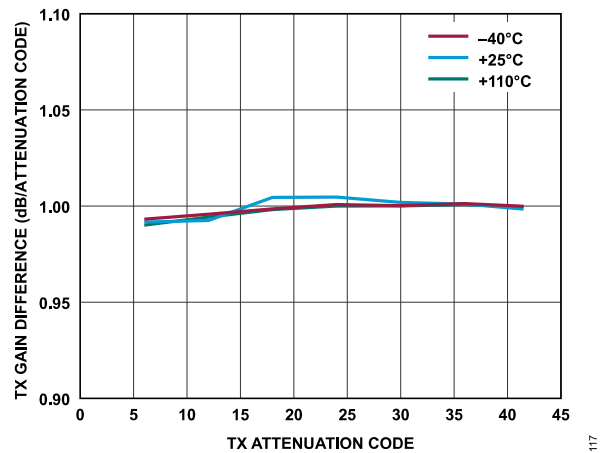

Figure 31. Transmitter Attenuation Delta (Error) vs. Transmitter Attenuation Code, Baseband Frequency = 18 MHz, Backoff = 0.2 dBFS

TYPICAL PERFORMANCE CHARACTERISTICS

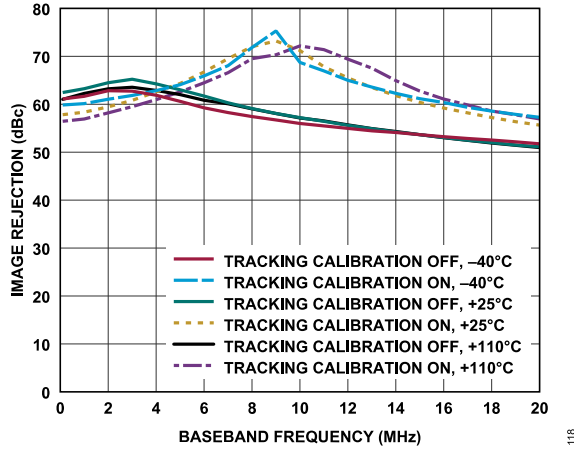

Figure 32. Transmitter Image Rejection vs. Baseband Frequency, Tracking Calibration On vs. Tracking Calibration Off, Transmitter Attenuation Code = 0

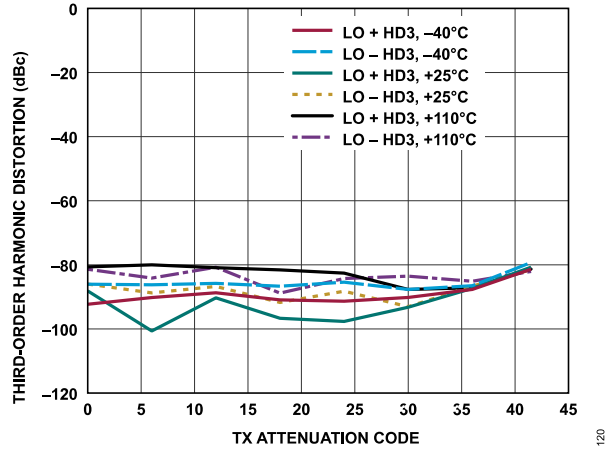

Figure 35. Transmitter Third-Order Harmonic Distortion vs. Transmitter Attenuation Code, Baseband Frequency = 18 MHz, Backoff = 0.2 dBFS

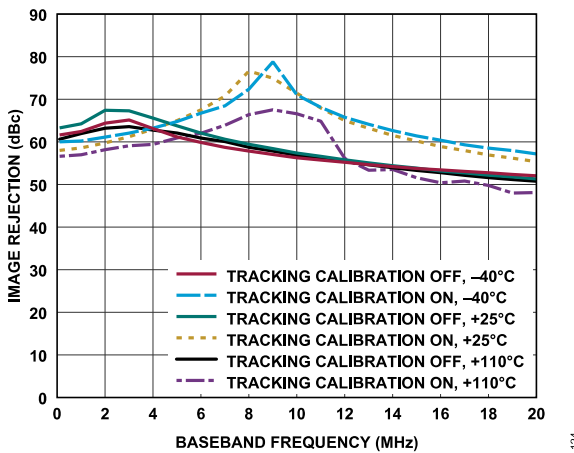

Figure 33. Transmitter Image Rejection vs. Baseband Frequency, Tracking Calibration On vs. Tracking Calibration Off, Transmitter Attenuation Code = 20

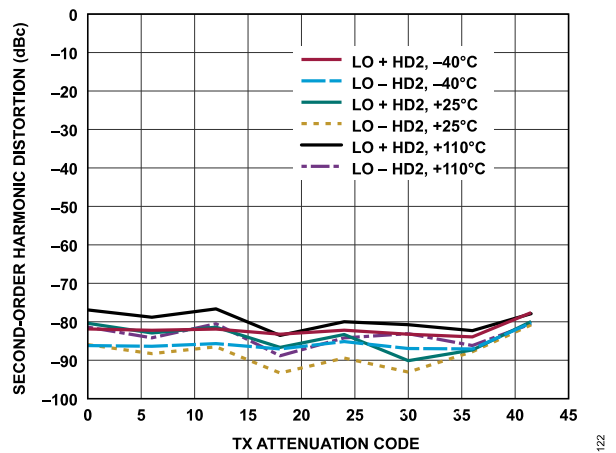

Figure 36. Transmitter Second-Order Harmonic Distortion vs. Transmitter Attenuation Code, Baseband Frequency = 18 MHz, Backoff = 0.2 dBFS

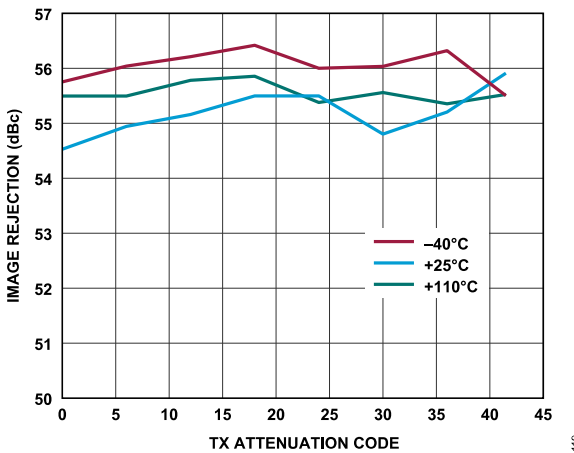

Figure 34. Transmitter Image Rejection vs. Transmitter Attenuation Code, Baseband Frequency = 18 MHz, Backoff = 0.2 dBFS, Initialization Calibration Only

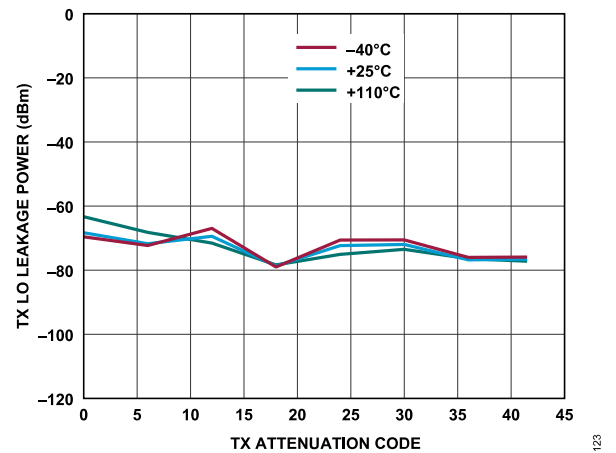

Figure 37. Transmitter LO Leakage Power vs. Transmitter Attenuation Code, Baseband Frequency = 18 MHz, Backoff = 6 dBFS, Initialization Calibration Only

TYPICAL PERFORMANCE CHARACTERISTICS

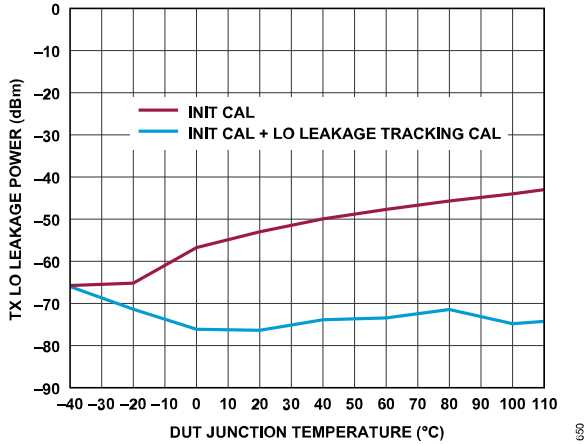

Figure 38. Transmitter LO Leakage Power vs. DUT Junction Temperature (Low to High), Baseband Frequency = 4 MHz, Backoff = 0.5 dBFS, Attenuation Code = 0

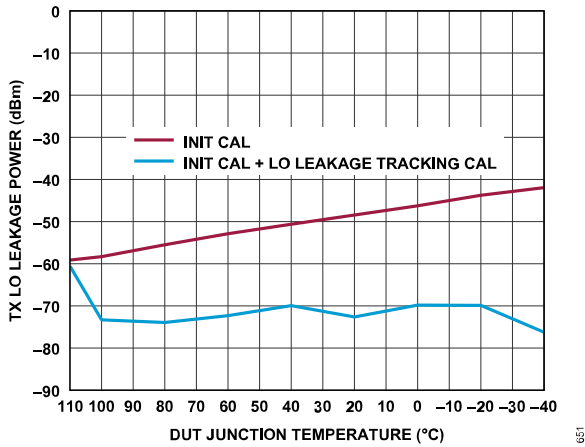

Figure 39. Transmitter LO Leakage Power vs. DUT Junction Temperature (High to Low), Baseband Frequency = 4 MHz, Backoff = 0.5 dBFS, Attenuation Code = 0

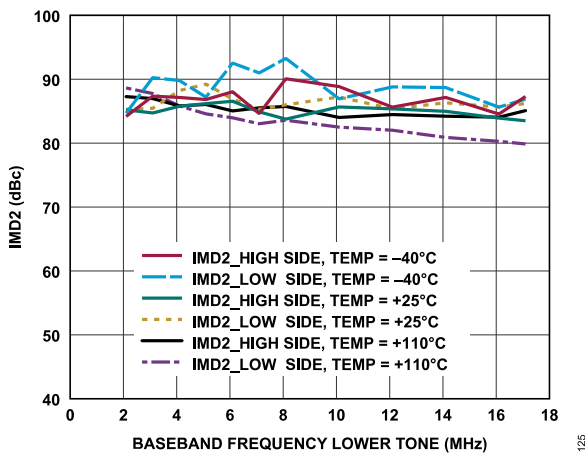

Figure 40. Transmitter Second-Order Intermodulation Distortion (IMD2) vs. Baseband Frequency, Transmitter Attenuation Code = 0, f_1 = Baseband Frequency, f_2 = Baseband Frequency + 1 MHz

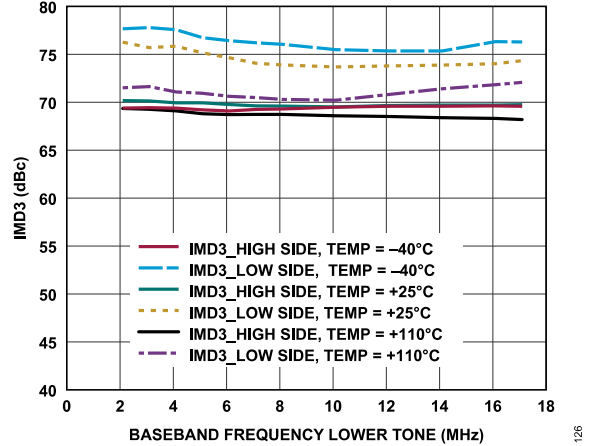

Figure 41. Transmitter Third-Order Intermodulation Distortion (IMD3) vs. Baseband Frequency, Transmitter Attenuation Code = 0, f_1 = Baseband Frequency, f_2 = Baseband Frequency + 1 MHz

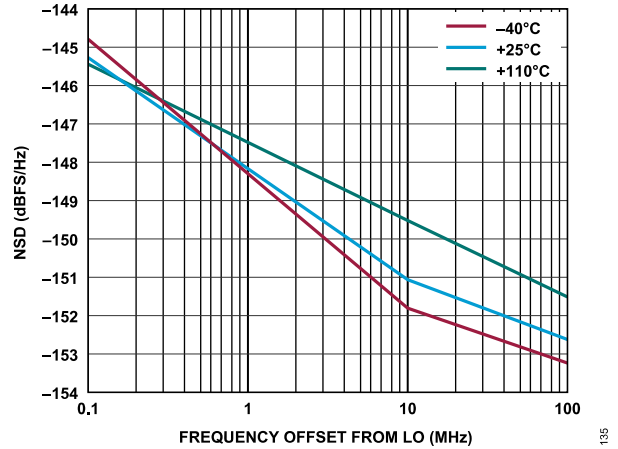

Figure 42. Transmitter NSD vs. Frequency Offset from LO, Baseband Frequency = 5.6 MHz, Transmitter Channel = Ch1

TYPICAL PERFORMANCE CHARACTERISTICS

470 MHz LO

The temperature settings refer to the die temperature. All LO frequencies set to 470 MHz, unless otherwise noted.

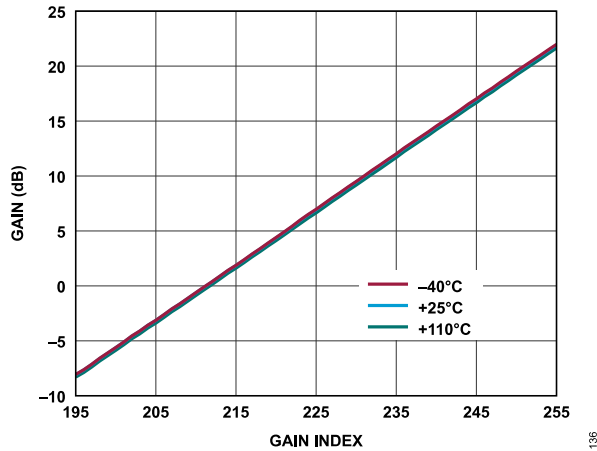

Figure 43. Receiver Absolute Gain (Complex) vs. Gain Index, Baseband Frequency = 5.6 MHz, ADC = High Performance, $P_{OUT} = -9.6$ dBFS

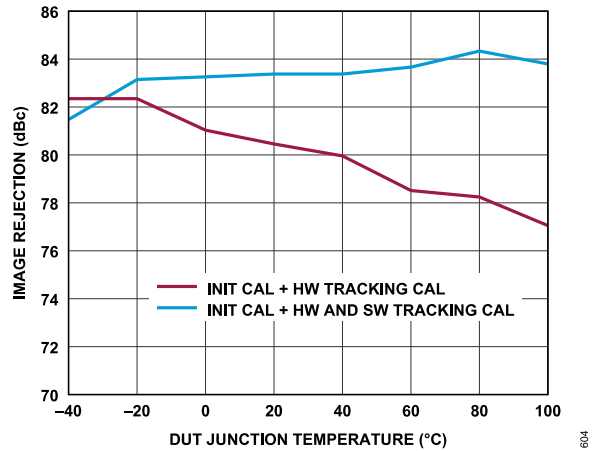

Figure 46. Receiver Image Rejection vs. DUT Junction Temperature (Low to High), Tone 1 Baseband Frequency = -5.1MHz, Tone 2 Baseband Frequency = 13.9 MHz, ADC = High Performance, $P_{OUT} = -11.1$ dBFS

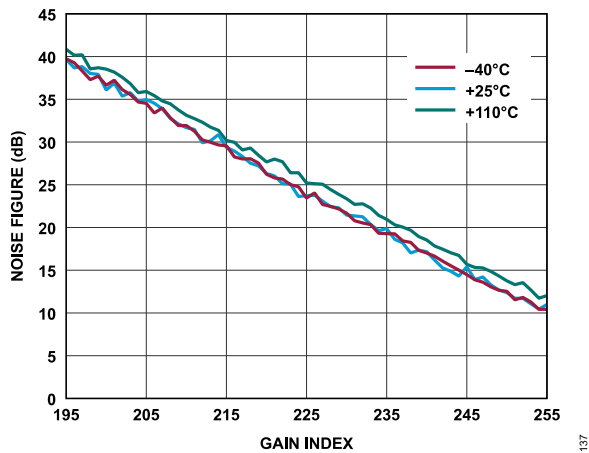

Figure 44. Receiver Noise Figure vs. Gain Index, Baseband Frequency = 5.6 MHz, ADC = High Performance

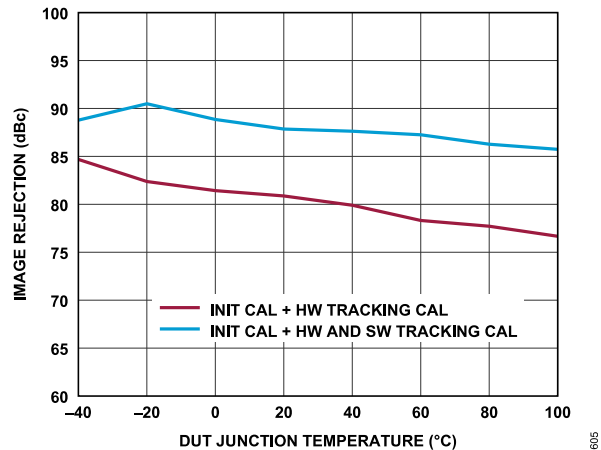

Figure 47. Receiver Image Rejection vs. DUT Junction Temperature (Low to High), Tone 1 Baseband Frequency = -5.1 MHz, Tone 2 Baseband Frequency = 13.9 MHz, ADC = Low Power, $P_{OUT} = -11.1$ dBFS

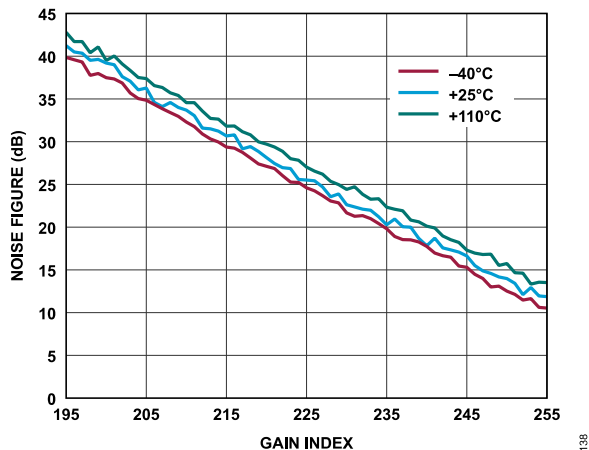

Figure 45. Receiver Noise Figure vs. Gain Index, Baseband Frequency = 5.6 MHz, ADC = Low Power

TYPICAL PERFORMANCE CHARACTERISTICS

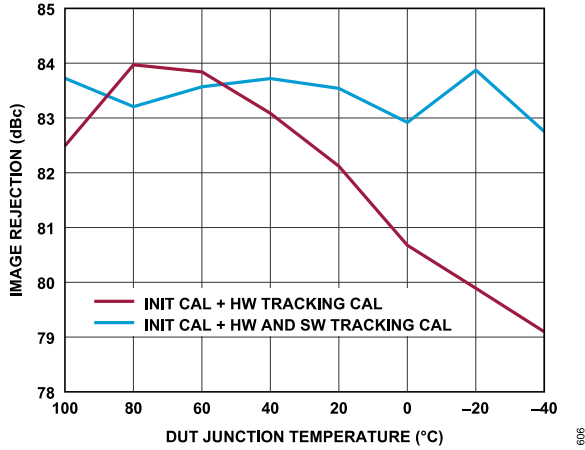

Figure 48. Receiver Image Rejection vs. DUT Junction Temperature (High to Low), Tone 1 Baseband Frequency = -5.1 MHz, Tone 2 Baseband Frequency = 13.9 MHz, ADC = High Performance, $P_{OUT} = -11.1$ dBFS

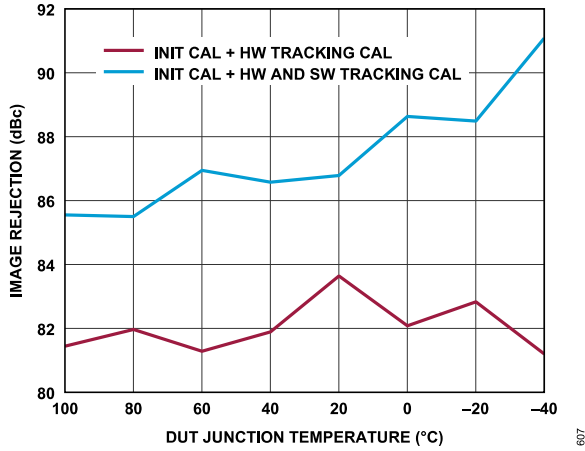

Figure 49. Receiver Image Rejection vs. DUT Junction Temperature (High to Low), Tone 1 Baseband Frequency = -5.1 MHz, Tone 2 Baseband Frequency = 13.9 MHz, ADC = Low Power, $P_{OUT} = -11.1$ dBFS

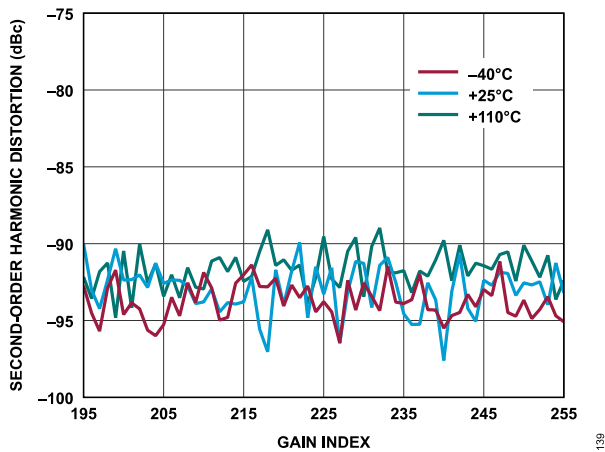

Figure 50. Receiver Second-Order Harmonic Distortion vs. Gain Index, Baseband Frequency = 5.6 MHz, ADC = High Performance

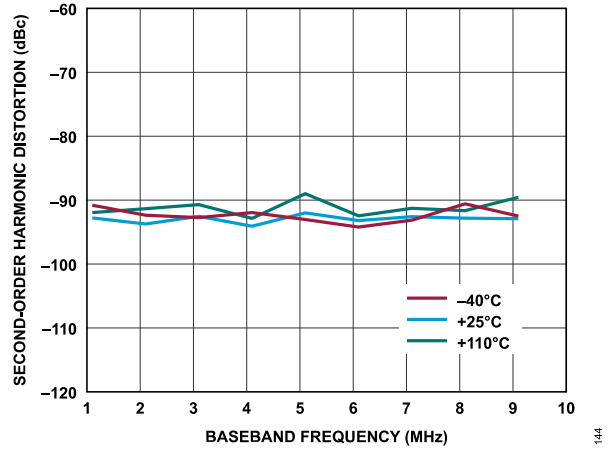

Figure 51. Receiver Second-Order Harmonic Distortion vs. Baseband Frequency, Gain Index = 255, ADC = High Performance

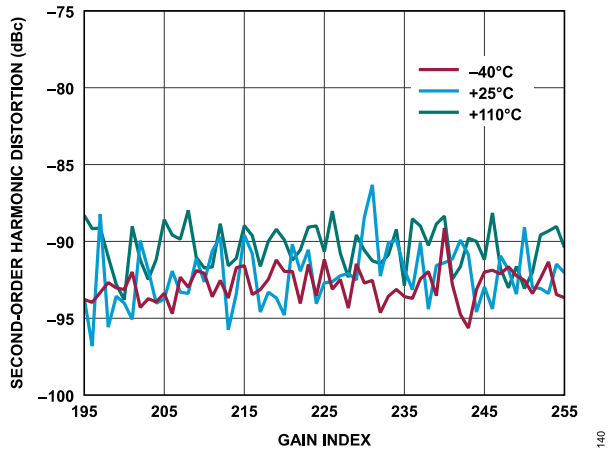

Figure 52. Receiver Second-Order Harmonic Distortion vs. Gain Index, Baseband Frequency = 5.6 MHz, ADC = Low Power

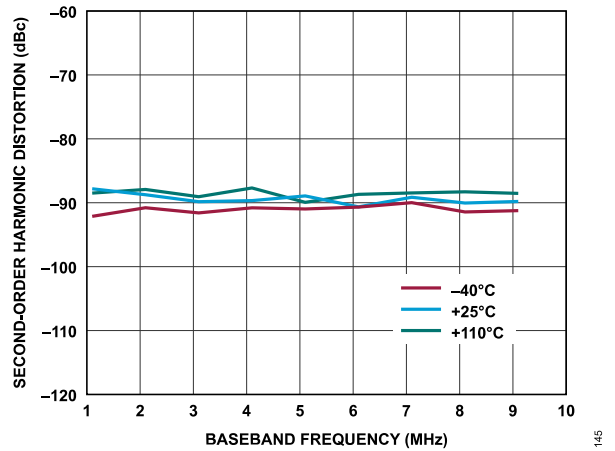

Figure 53. Receiver Second-Order Harmonic Distortion vs. Baseband Frequency, Gain Index = 255, ADC = Low Power

TYPICAL PERFORMANCE CHARACTERISTICS

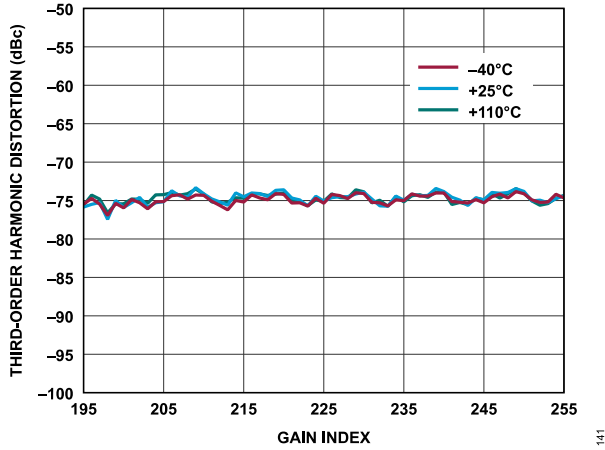

Figure 54. Receiver Third-Order Harmonic Distortion vs. Gain Index, Baseband Frequency = 5.6 MHz, ADC = High Performance

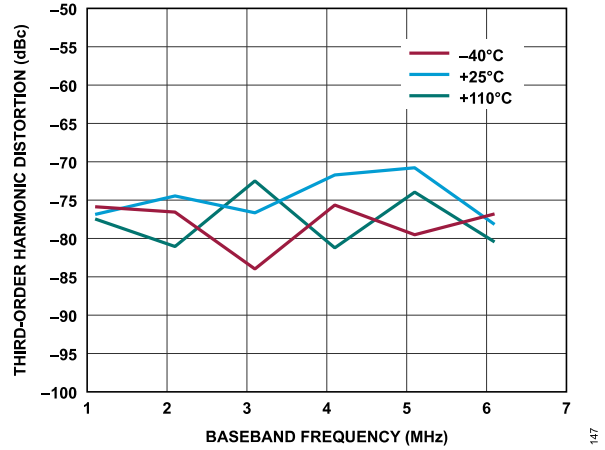

Figure 57. Receiver Third-Order Harmonic Distortion vs. Baseband Frequency, Gain Index = 255, ADC = Low Power

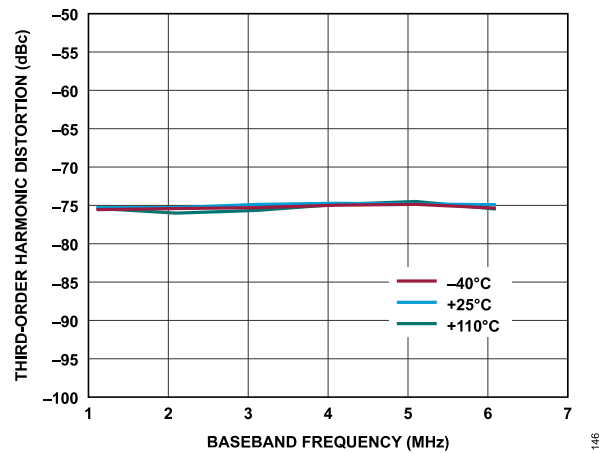

Figure 55. Receiver Third-Order Harmonic Distortion vs. Baseband Frequency, Gain Index = 255, ADC = High Performance

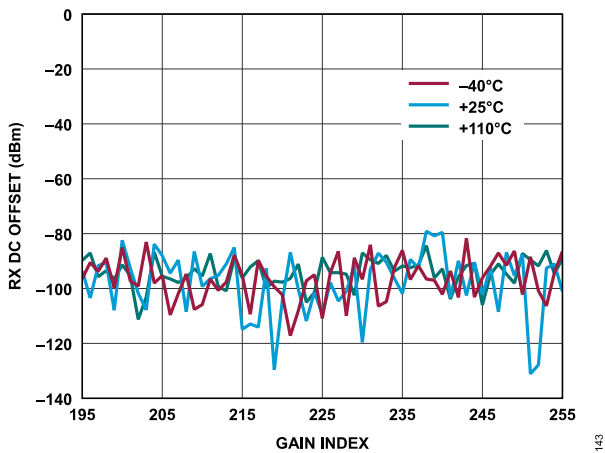

Figure 58. Receiver DC Offset vs. Gain Index, Baseband Frequency = 5.6 MHz, ADC = High Performance

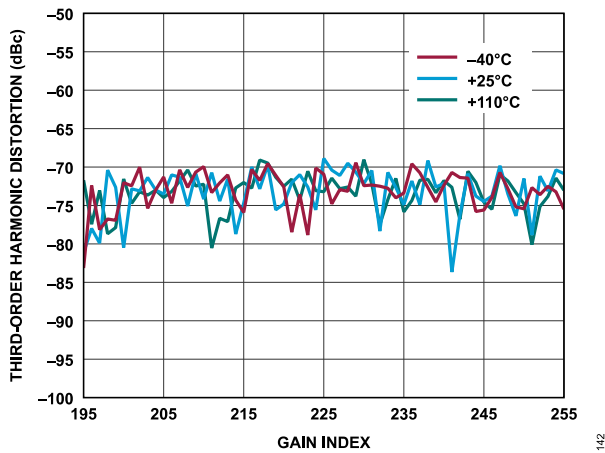

Figure 56. Receiver Third-Order Harmonic Distortion vs. Gain Index, Baseband Frequency = 5.6 MHz, ADC = Low Power

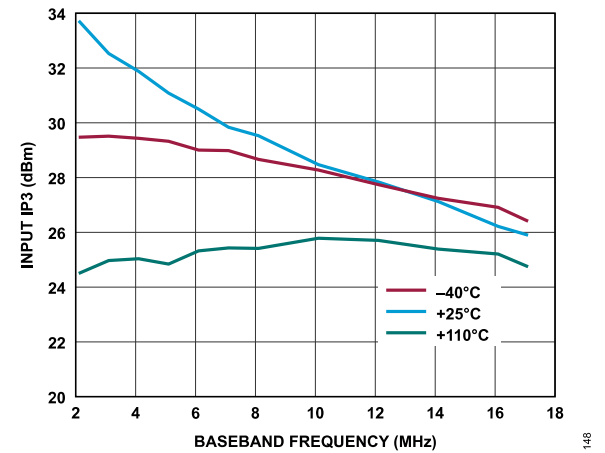

Figure 59. Receiver Input IP3 vs. Baseband Frequency, ADC = High Performance, f_1 = Baseband Frequency, f_2 = Baseband Frequency + 1 MHz, Gain Index = 255

TYPICAL PERFORMANCE CHARACTERISTICS

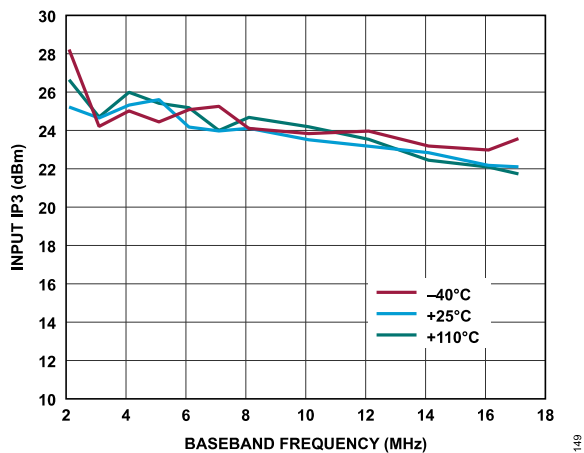

Figure 60. Receiver Input IP3 vs. Baseband Frequency, ADC = Low Power, f_1 = Baseband Frequency, f_2 = Baseband Frequency + 1 MHz, Gain Index = 255

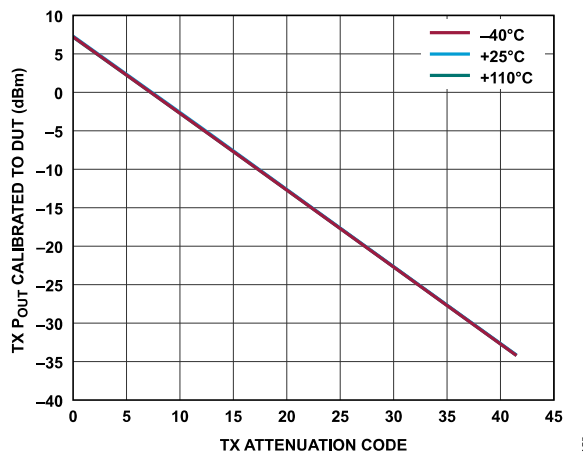

Figure 63. Transmitter Absolute Power vs. Transmitter Attenuation Code, Baseband Frequency = 18 MHz, Backoff = 0.2 dBFS

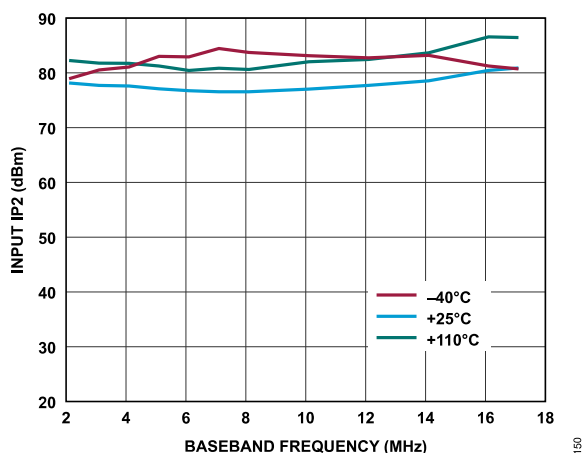

Figure 61. Receiver Input IP2 vs. Baseband Frequency, ADC = High Performance, f_1 = Baseband Frequency, f_2 = Baseband Frequency + 1 MHz, Gain Index = 255

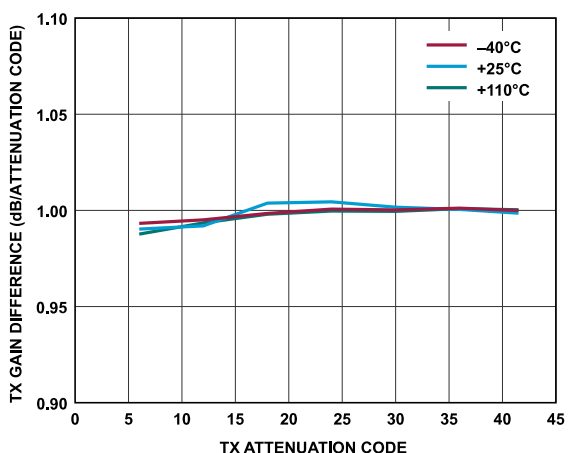

Figure 64. Transmitter Attenuation Delta (Error) vs. Transmitter Attenuation Code, Baseband Frequency = 18 MHz, Backoff = 0.2 dBFS

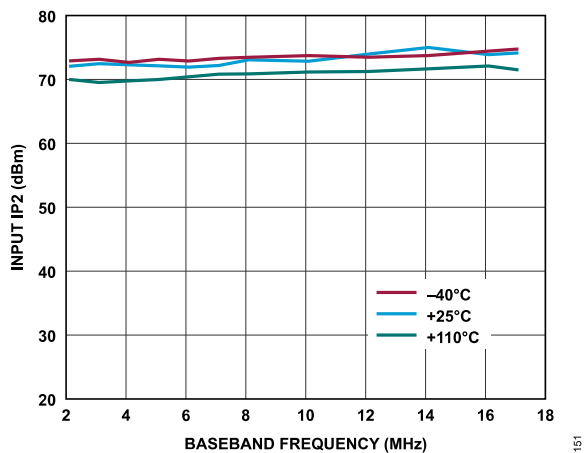

Figure 62. Receiver Input IP2 vs. Baseband Frequency, ADC = Low Power, f_1 = Baseband Frequency, f_2 = Baseband Frequency + 1 MHz, Gain Index = 255

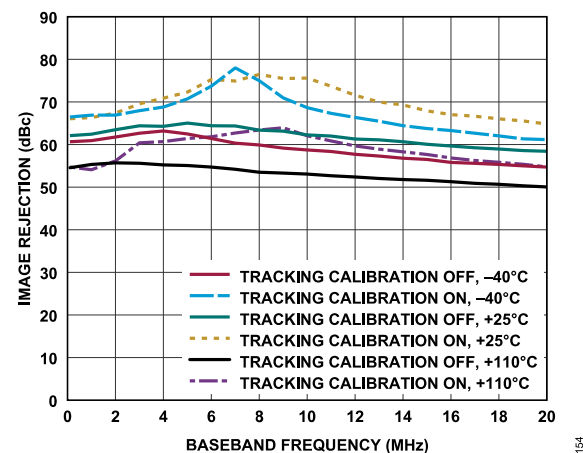

Figure 65. Transmitter Image Rejection vs. Baseband Frequency, Tracking Calibration On vs. Tracking Calibration Off, Transmitter Attenuation Code = 0

TYPICAL PERFORMANCE CHARACTERISTICS

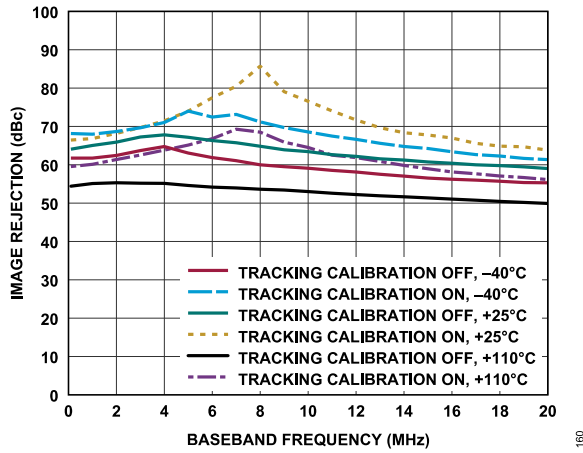

Figure 66. Transmitter Image Rejection vs. Baseband Frequency, Tracking Calibration On vs. Tracking Calibration Off, Transmitter Attenuation Code = 20

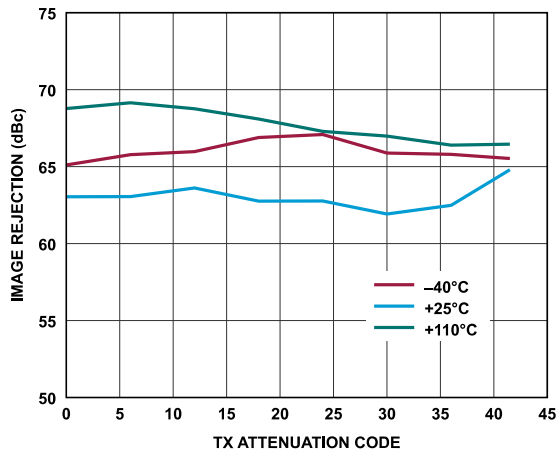

Figure 67. Transmitter Image Rejection vs. Transmitter Attenuation Code, Baseband Frequency = 18 MHz, Backoff = 0.2 dBFS, Initialization Calibration Only

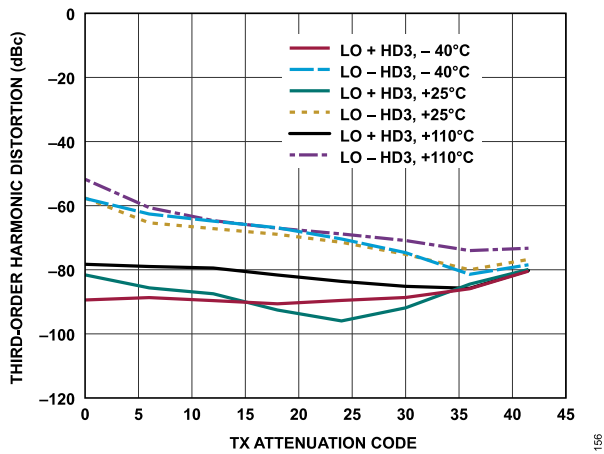

Figure 68. Transmitter Third-Order Harmonic Distortion vs. Transmitter Attenuation Code, Baseband Frequency = 18 MHz, Backoff = 0.2 dBFS

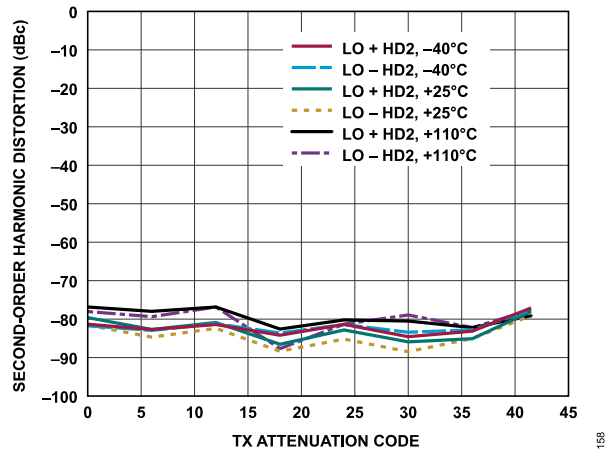

Figure 69. Transmitter Second-Order Harmonic Distortion vs. Transmitter Attenuation Code, Baseband Frequency = 18 MHz, Backoff = 0.2 dBFS

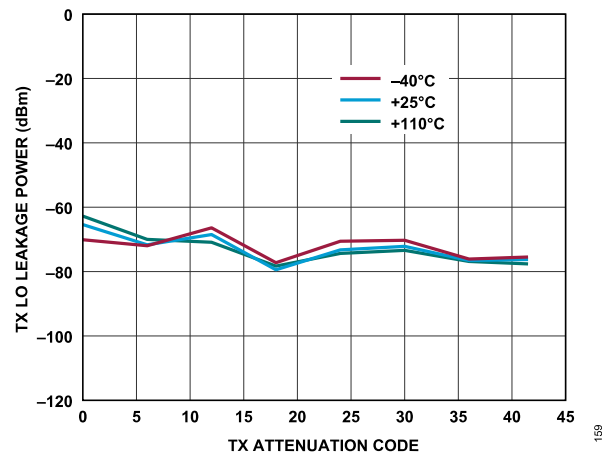

Figure 70. Transmitter LO Leakage Power vs. Transmitter Attenuation Code, Baseband Frequency = 18 MHz, Backoff = 6 dBFS, Initialization Calibration Only

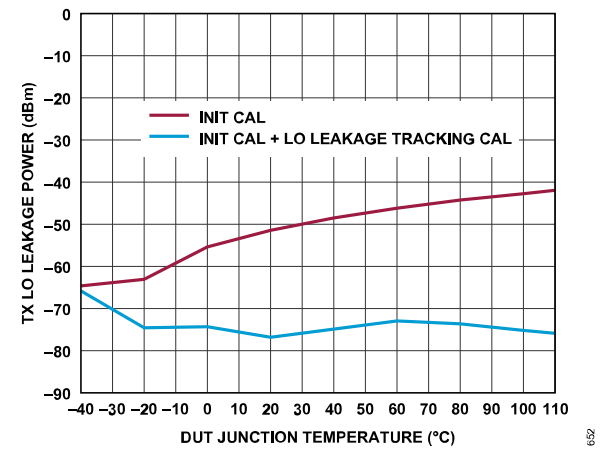

Figure 71. Transmitter LO Leakage Power vs. DUT Junction Temperature (Low to High), Baseband Frequency = 4 MHz, Backoff = 0.5 dBFS, Attenuation Code = 0

TYPICAL PERFORMANCE CHARACTERISTICS

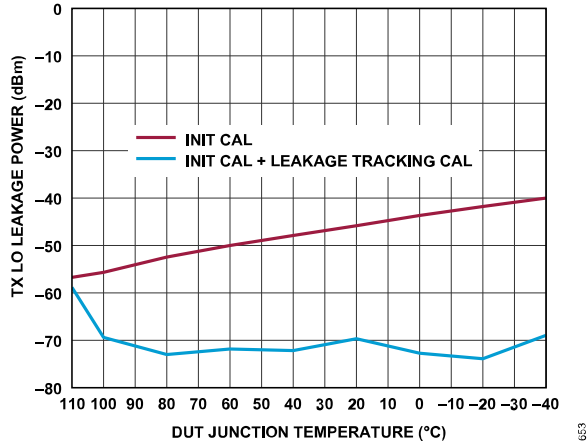

Figure 72. Transmitter LO Leakage Power vs. DUT Junction Temperature (High to Low), Baseband Frequency = 4 MHz, Backoff = 0.5 dBFS, Attenuation Code = 0

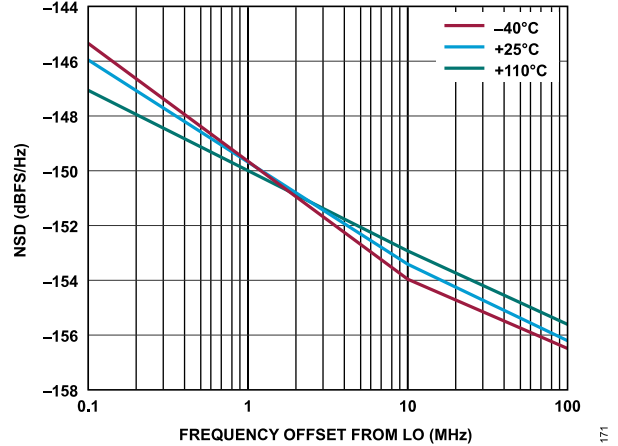

Figure 75. Transmitter NSD vs. Frequency Offset from LO, Baseband Frequency = 5.6 MHz, Transmitter Channel = Ch1

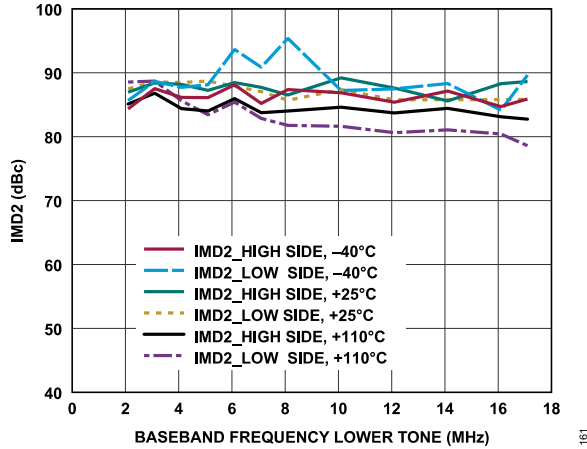

Figure 73. Transmitter IMD2 vs. Baseband Frequency, Transmitter Attenuation Code = 0, f_1 = Baseband Frequency, f_2 = Baseband Frequency + 1 MHz

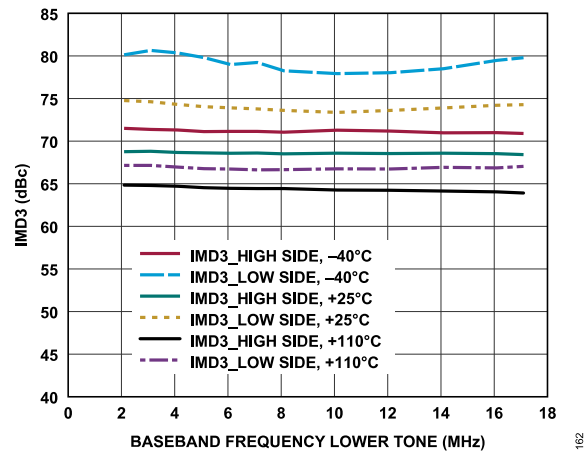

Figure 74. Transmitter IMD3 vs. Baseband Frequency, Transmitter Attenuation Code = 0, f_1 = Baseband Frequency, f_2 = Baseband Frequency + 1 MHz

TYPICAL PERFORMANCE CHARACTERISTICS

900 MHz LO

The temperature settings refer to the die temperature. All LO frequencies set to 900 MHz, unless otherwise noted.

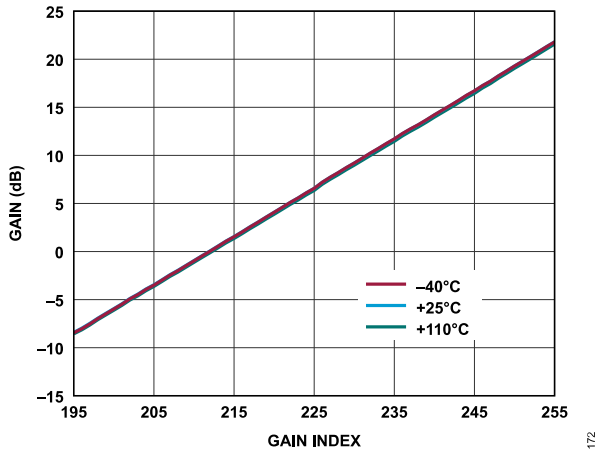

Figure 76. Receiver Absolute Gain (Complex) vs. Gain Index, Baseband Frequency = 5.6 MHz, ADC = High Performance, $P_{OUT} = -9.6$ dBFS

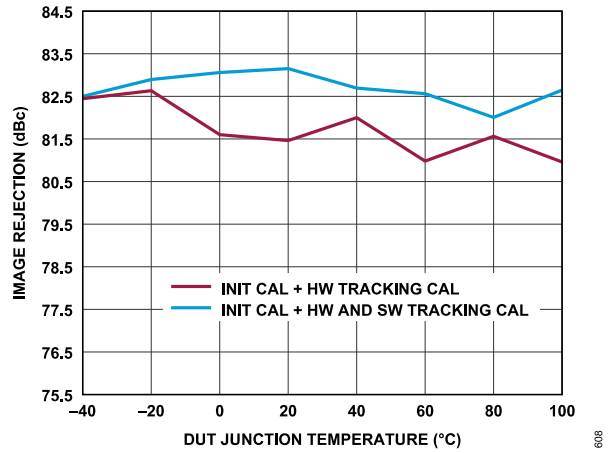

Figure 79. Receiver Image Rejection vs. DUT Junction Temperature (Low to High), Tone 1 Baseband Frequency = -5.1 MHz, Tone 2 Baseband Frequency = 13.9 MHz, ADC = High Performance, $P_{OUT} = -11.1$ dBFS

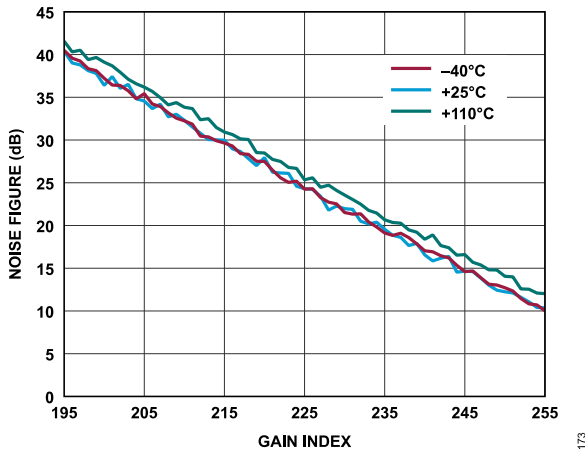

Figure 77. Receiver Noise Figure vs. Gain Index, Baseband Frequency = 5.6 MHz, ADC = High Performance

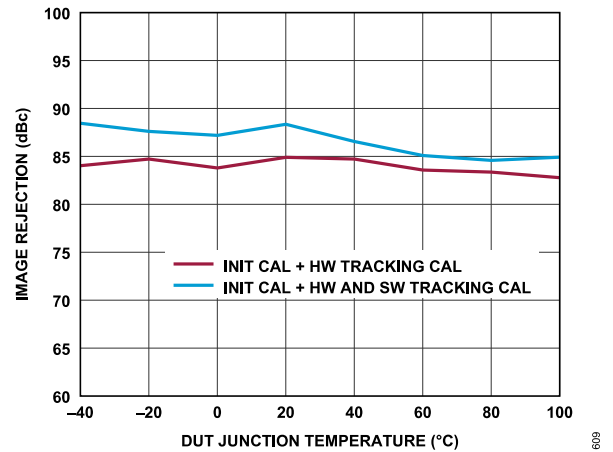

Figure 80. Receiver Image Rejection vs. DUT Junction Temperature (Low to High), Tone 1 Baseband Frequency = -5.1 MHz, Tone 2 Baseband Frequency = 13.9 MHz, ADC = Low Power, $P_{OUT} = -11.1$ dBFS

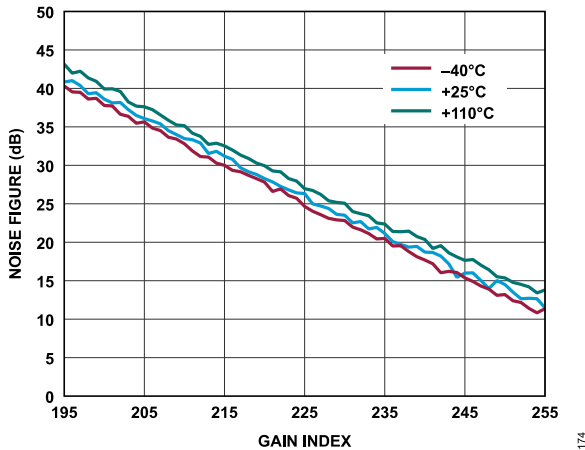

Figure 78. Receiver Noise Figure vs. Gain Index, Baseband Frequency = 5.6 MHz, ADC = Low Power

TYPICAL PERFORMANCE CHARACTERISTICS

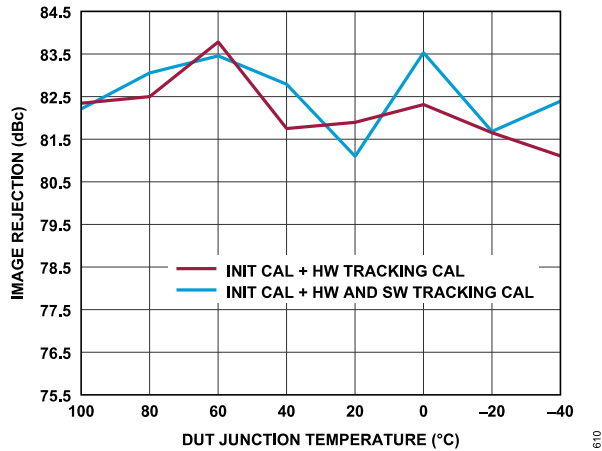

Figure 81. Receiver Image Rejection vs. DUT Junction Temperature (High to Low), Tone 1 Baseband Frequency = -5.1 MHz, Tone 2 Baseband Frequency = 13.9 MHz, ADC = High Performance, $P_{OUT} = -11.1$ dBFS

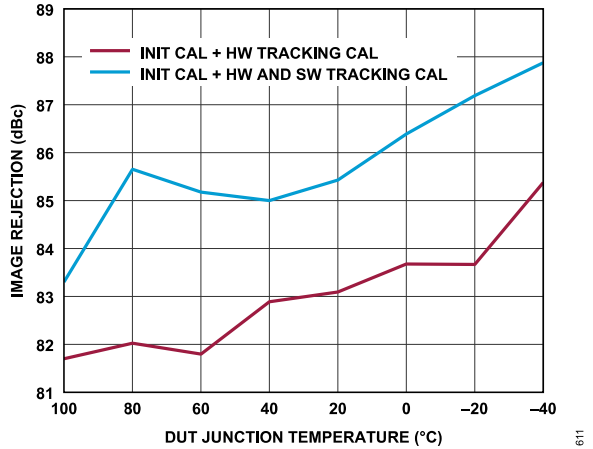

Figure 82. Receiver Image Rejection vs. DUT Junction Temperature (High to Low), Tone 1 Baseband Frequency = -5.1 MHz, Tone 2 Baseband Frequency = 13.9 MHz, ADC = Low Power, $P_{OUT} = -11.1$ dBFS

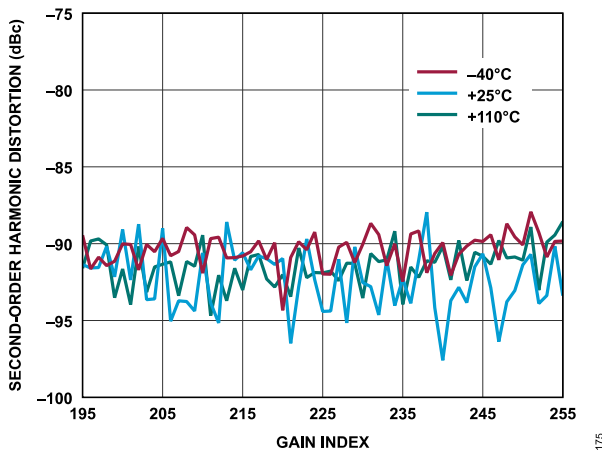

Figure 83. Receiver Second-Order Harmonic Distortion vs. Gain Index, Baseband Frequency = 5.6 MHz, ADC = High Performance

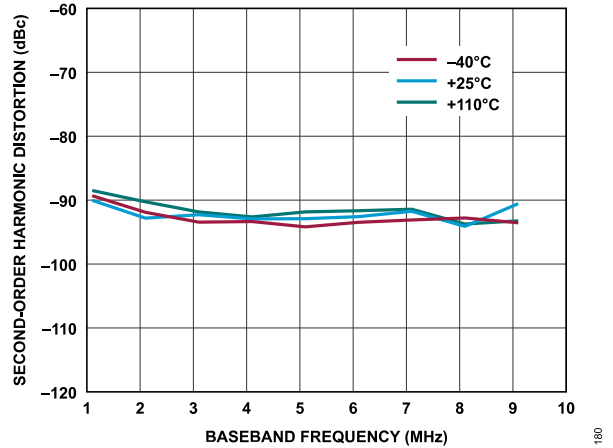

Figure 84. Receiver Second-Order Harmonic Distortion vs. Baseband Frequency, Gain Index = 255, ADC = High Performance

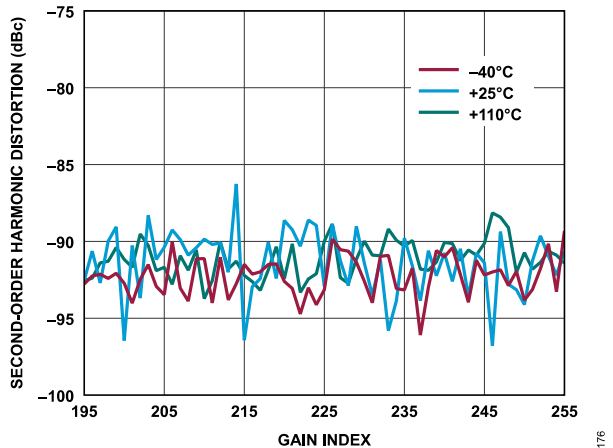

Figure 85. Receiver Second-Order Harmonic Distortion vs. Gain Index, Baseband Frequency = 5.6 MHz, ADC = Low Power

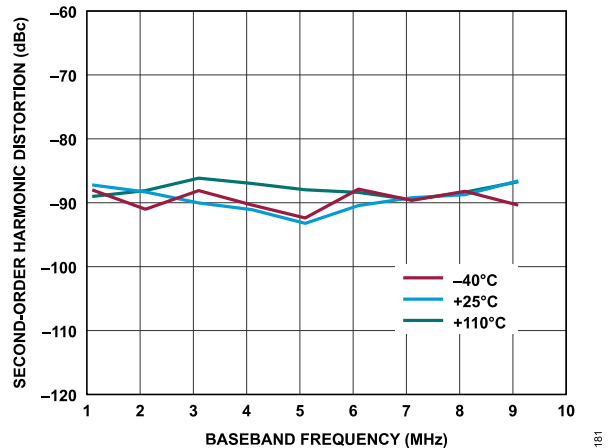

Figure 86. Receiver Second-Order Harmonic Distortion vs. Baseband Frequency, Gain Index = 255, ADC = Low Power

TYPICAL PERFORMANCE CHARACTERISTICS

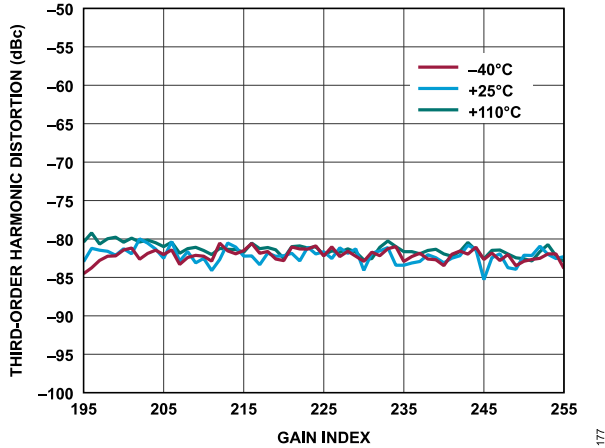

Figure 87. Receiver Third-Order Harmonic Distortion vs. Gain Index, Baseband Frequency = 5.6 MHz, ADC = High Performance

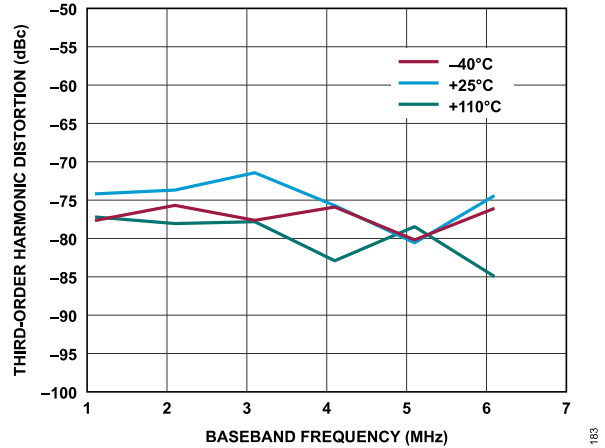

Figure 90. Receiver Third-Order Harmonic Distortion vs. Baseband Frequency, Gain Index = 255, ADC = Low Power

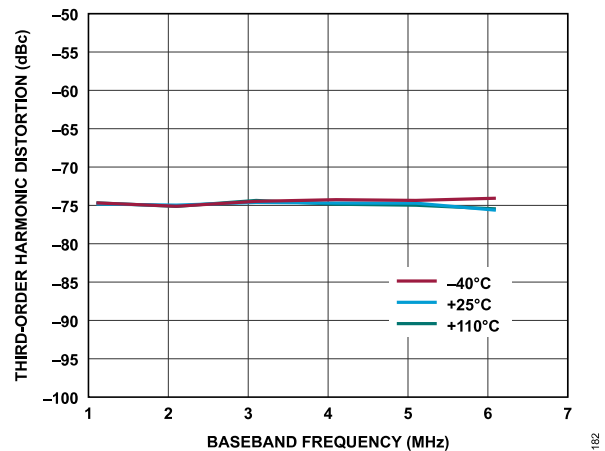

Figure 88. Receiver Third-Order Harmonic Distortion vs. Baseband Frequency, Gain Index = 255, ADC = High Performance

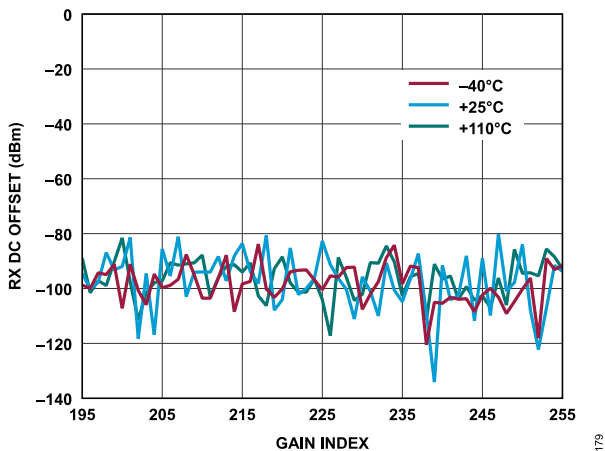

Figure 91. Receiver DC Offset vs. Gain Index, Baseband Frequency = 5.6 MHz, ADC = High Performance

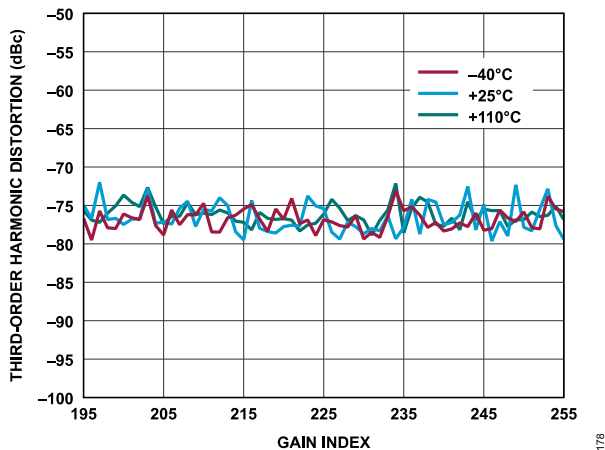

Figure 89. Receiver Third-Order Harmonic Distortion vs. Gain Index, Baseband Frequency = 5.6 MHz, ADC = Low Power

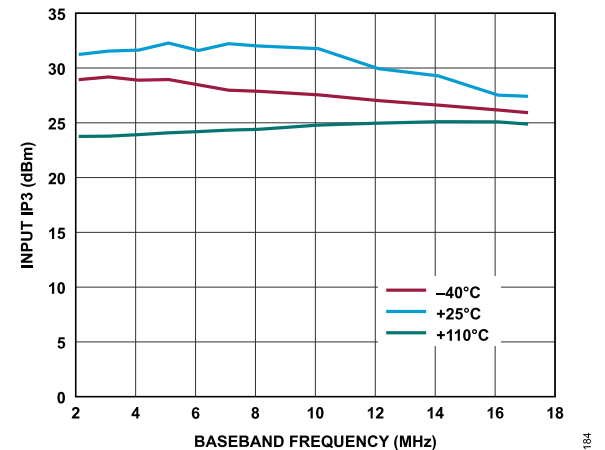

Figure 92. Receiver Input IP3 vs. Baseband Frequency, ADC = High Performance, f_1 = Baseband Frequency, f_2 = Baseband Frequency + 1 MHz, Gain Index = 255

TYPICAL PERFORMANCE CHARACTERISTICS

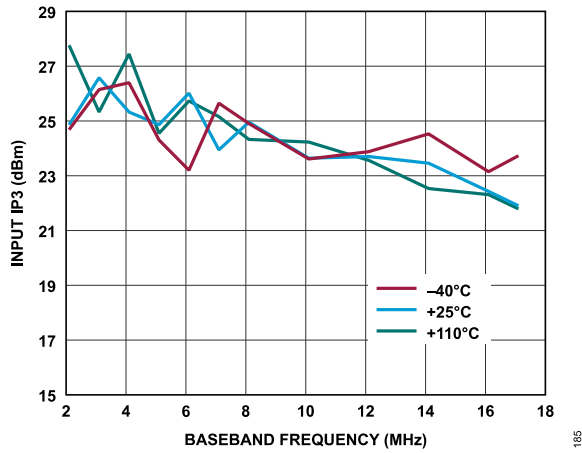

Figure 93. Receiver Input IP3 vs. Baseband Frequency, ADC = Low Power, f_1 = Baseband Frequency, f_2 = Baseband Frequency + 1 MHz, Gain Index = 255

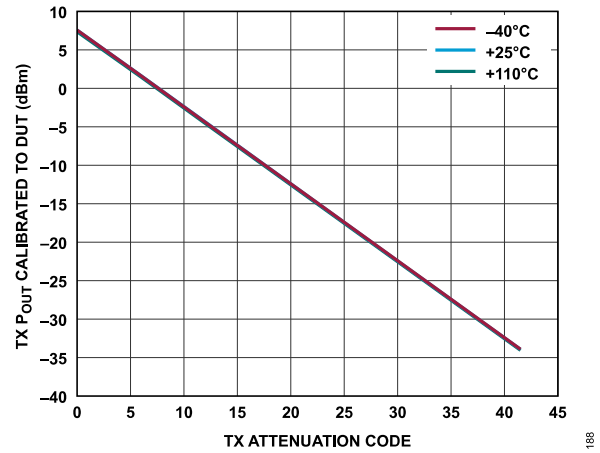

Figure 96. Transmitter Absolute Power vs. Transmitter Attenuation Code, Baseband Frequency = 18 MHz, Backoff = 0.2 dBFS

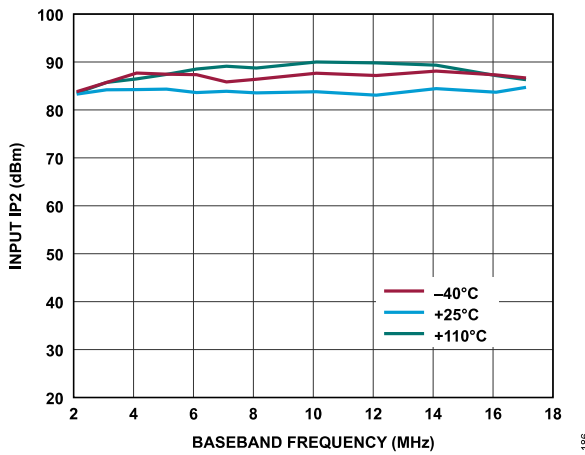

Figure 94. Receiver Input IP2 vs. Baseband Frequency, ADC = High Performance, f_1 = Baseband Frequency, f_2 = Baseband Frequency + 1 MHz, Gain Index = 255

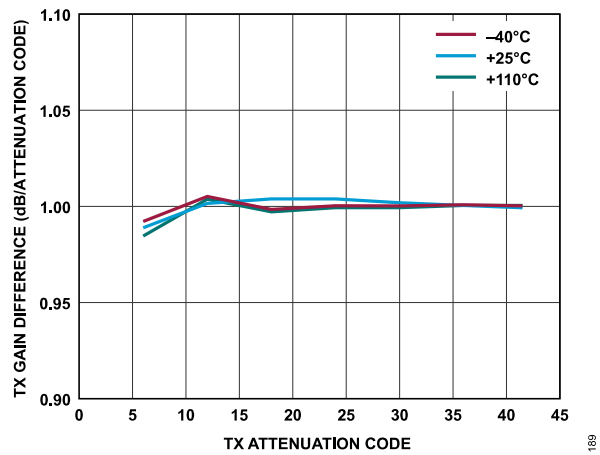

Figure 97. Transmitter Attenuation Delta (Error) vs. Transmitter Attenuation Code, Baseband Frequency = 18 MHz, Backoff = 0.2 dBFS

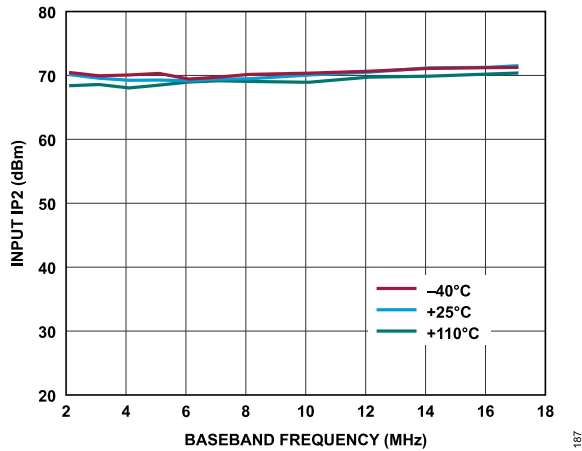

Figure 95. Receiver Input IP2 vs. Baseband Frequency, ADC = Low Power, f_1 = Baseband Frequency, f_2 = Baseband Frequency + 1 MHz, Gain Index = 255

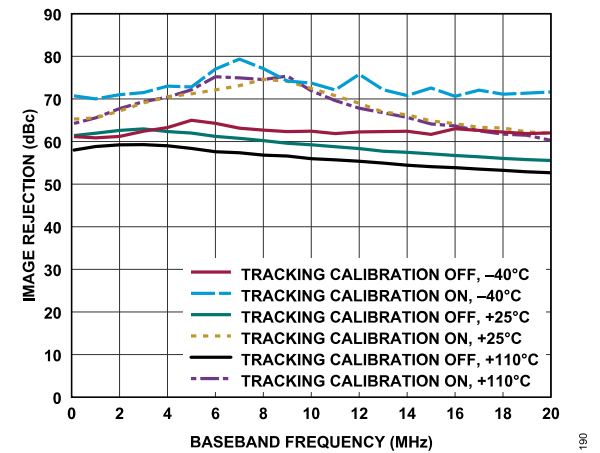

Figure 98. Transmitter Image Rejection vs. Baseband Frequency, Tracking Calibration On vs. Tracking Calibration Off, Transmitter Attenuation Code = 0

TYPICAL PERFORMANCE CHARACTERISTICS

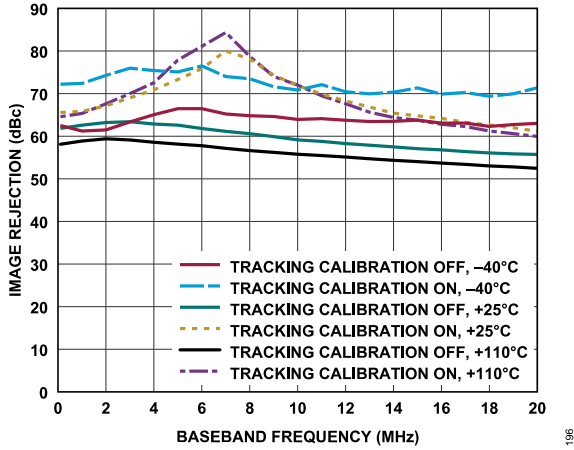

Figure 99. Transmitter Image Rejection vs. Baseband Frequency, Tracking Calibration On vs. Tracking Calibration Off, Transmitter Attenuation Code = 20

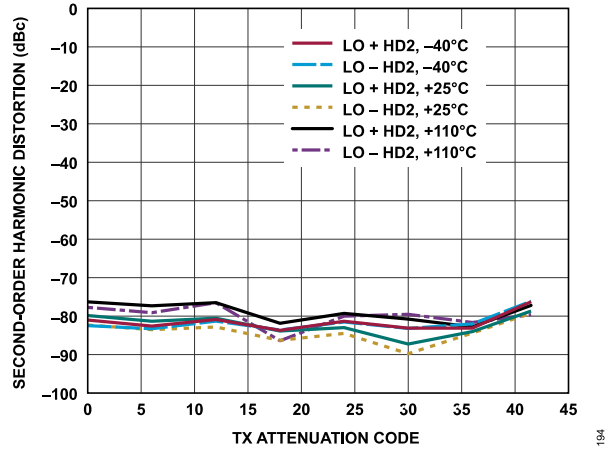

Figure 102. Transmitter Second-Order Harmonic Distortion vs. Transmitter Attenuation Code, Baseband Frequency = 18 MHz, Backoff = 0.2 dBFS

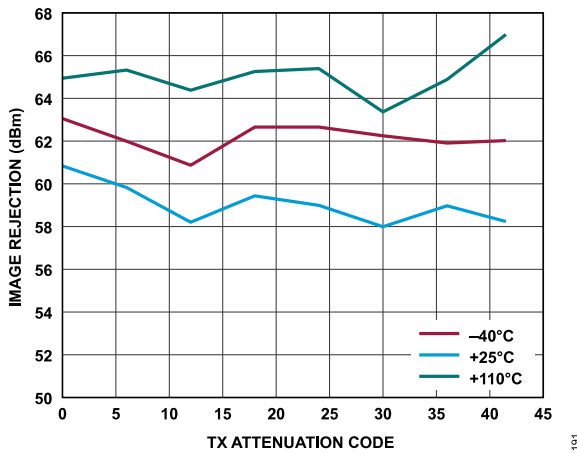

Figure 100. Transmitter Image Rejection vs. Transmitter Attenuation Code, Baseband Frequency = 18 MHz, Backoff = 0.2 dBFS, Initialization Calibration Only

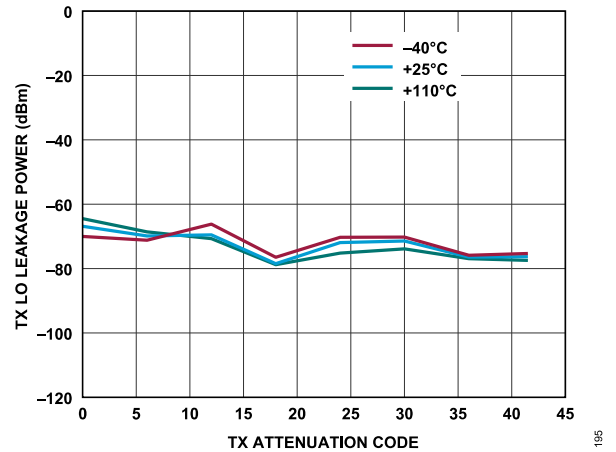

Figure 103. Transmitter LO Leakage Power vs. Attenuation Code, Baseband Frequency = 18 MHz, Backoff = 6 dBFS, Initialization Calibration Only

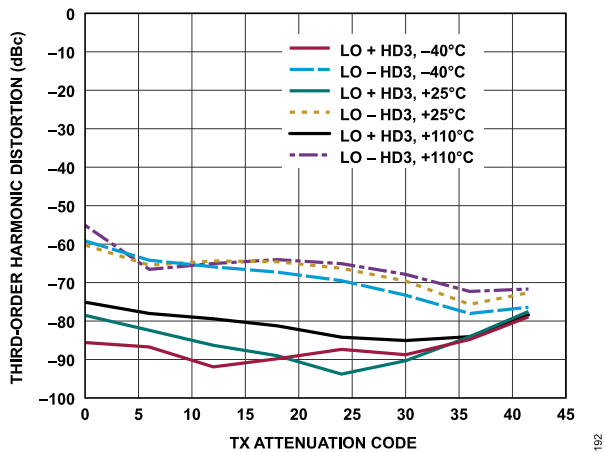

Figure 101. Transmitter Third-Order Harmonic Distortion vs. Transmitter Attenuation Code, Baseband Frequency = 18 MHz, Backoff = 0.2 dBFS

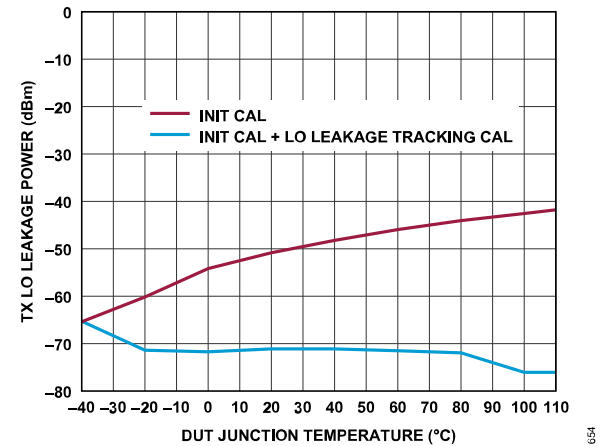

Figure 104. Transmitter LO Leakage Power vs. DUT Junction Temperature (Low to High), Baseband Frequency = 4 MHz, Backoff = 0.5 dBFS, Attenuation Code = 0

TYPICAL PERFORMANCE CHARACTERISTICS

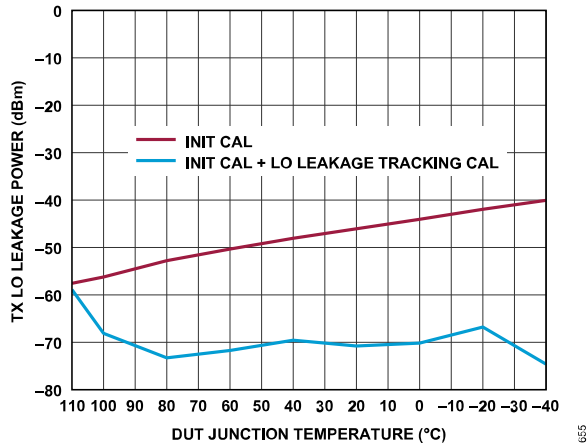

Figure 105. Transmitter LO Leakage Power vs. DUT Junction Temperature (High to Low), Baseband Frequency = 4 MHz, Backoff = 0.5 dBFS, Attenuation Code = 0

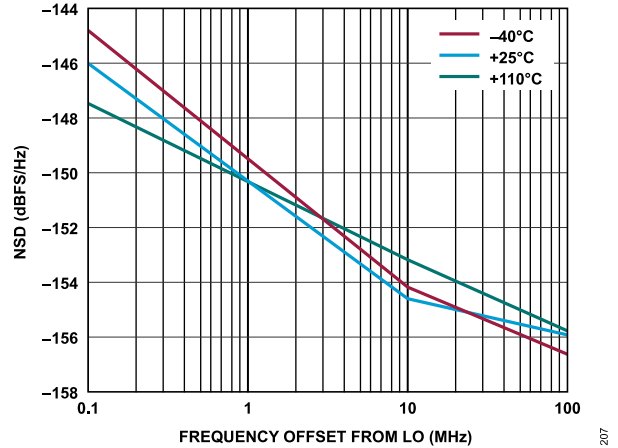

Figure 108. Transmitter NSD vs. Frequency Offset from LO, Baseband Frequency = 5.6 MHz, Transmitter Channel = Ch1

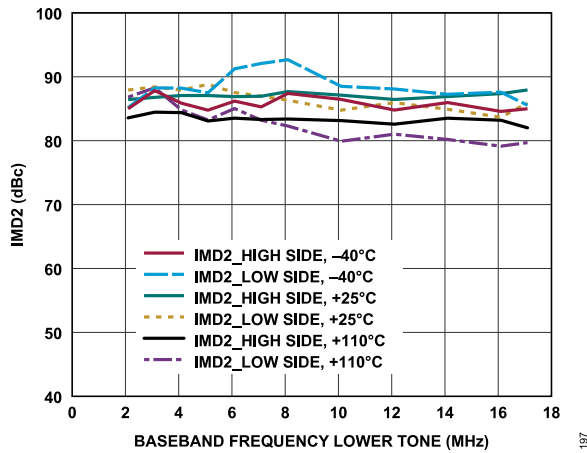

Figure 106. Transmitter IMD2 vs. Baseband Frequency, Transmitter Attenuation Code = 0, f_1 = Baseband Frequency, f_2 = Baseband Frequency + 1 MHz

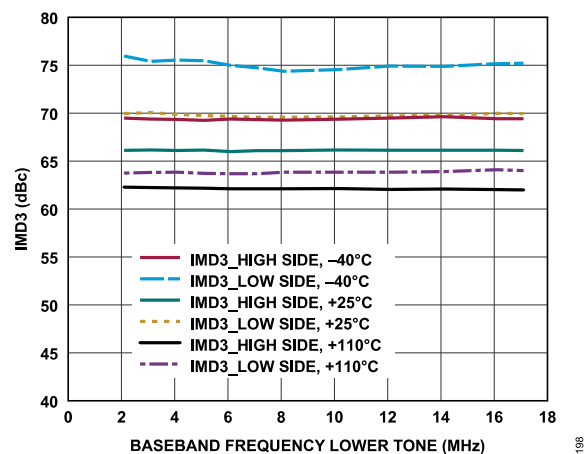

Figure 107. Transmitter IMD3 vs. Baseband Frequency, Transmitter Attenuation Code = 0, f_1 = Baseband Frequency, f_2 = Baseband Frequency + 1 MHz

TYPICAL PERFORMANCE CHARACTERISTICS

2400 MHz LO

The temperature settings refer to the die temperature. All LO frequencies set to 2400 MHz, unless otherwise noted.

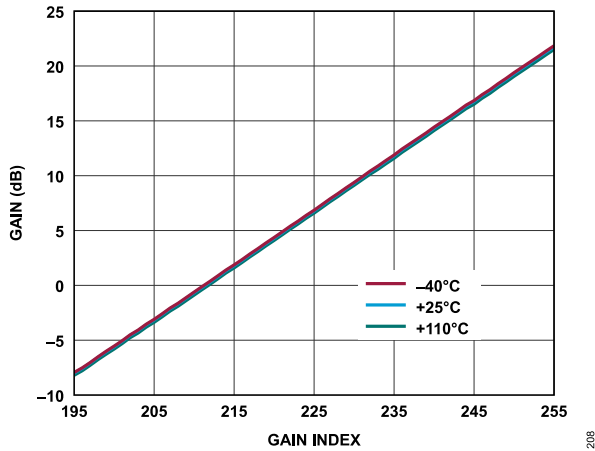

Figure 109. Receiver Absolute Gain (Complex) vs. Gain Index, Baseband Frequency = 5.6 MHz, ADC = High Performance, $P_{OUT} = -9.6$ dBFS

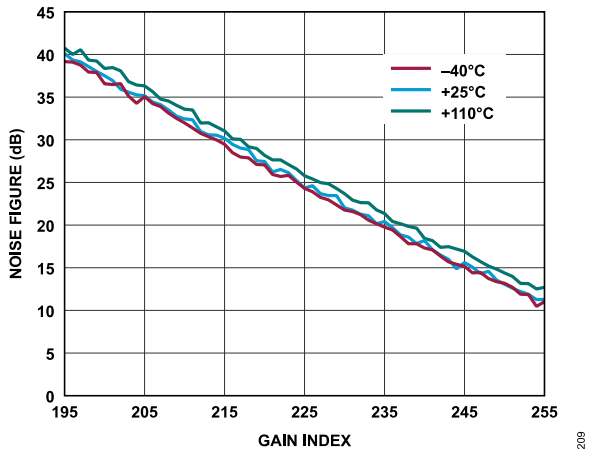

Figure 110. Receiver Noise Figure vs. Gain Index, Baseband Frequency = 5.6 MHz, ADC = High Performance

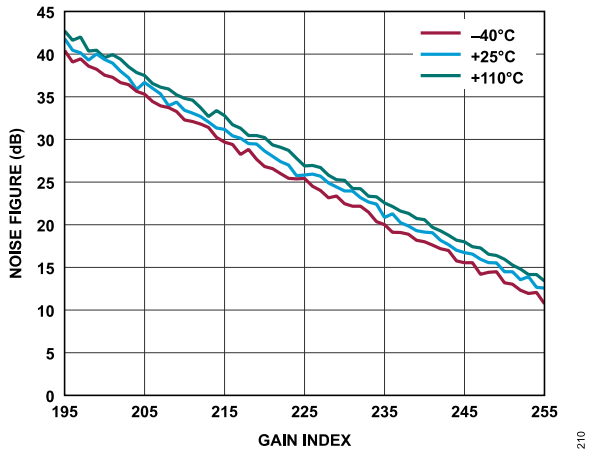

Figure 111. Receiver Noise Figure vs. Gain Index, Baseband Frequency = 5.6 MHz, ADC = Low Power

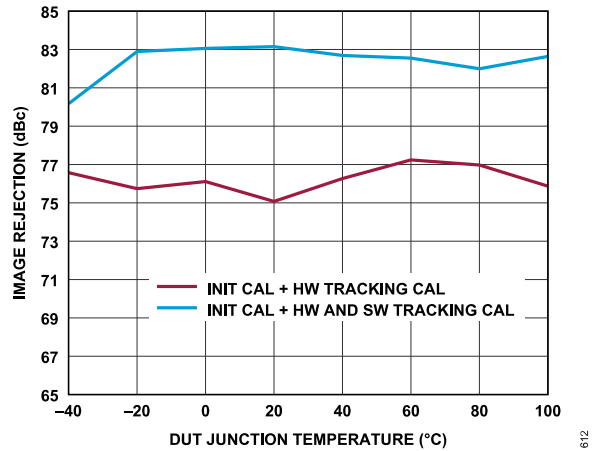

Figure 112. Receiver Image Rejection vs. DUT Junction Temperature (Low to High), Tone 1 Baseband Frequency = -5.1 MHz, Tone 2 Baseband Frequency = 13.9 MHz, ADC = High Performance, $P_{OUT} = -11.1$ dBFS

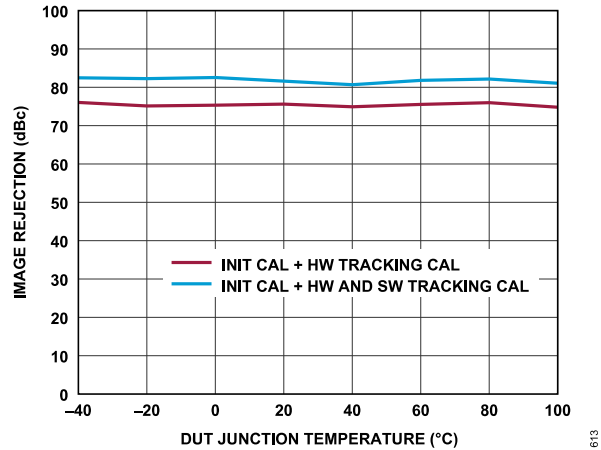

Figure 113. Receiver Image Rejection vs. DUT Junction Temperature (Low to High), Tone 1 Baseband Frequency = -5.1 MHz, Tone 2 Baseband Frequency = 13.9 MHz, ADC = Low Power, $P_{OUT} = -11.1$ dBFS

TYPICAL PERFORMANCE CHARACTERISTICS

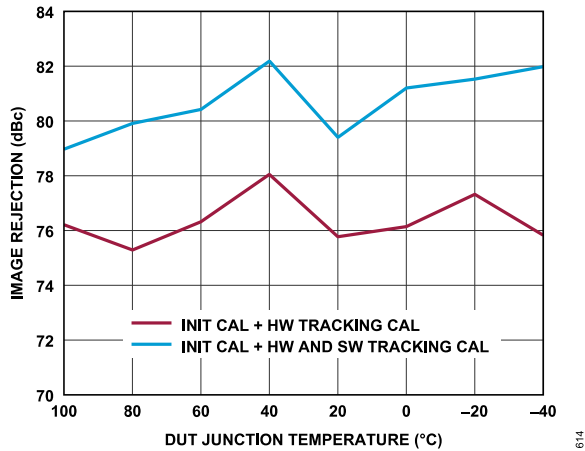

Figure 114. Receiver Image Rejection vs. DUT Junction Temperature (High to Low), Tone 1 Baseband Frequency = -5.1 MHz, Tone 2 Baseband Frequency = 13.9 MHz, ADC = High Performance, $P_{OUT} = -11.1$ dBFS

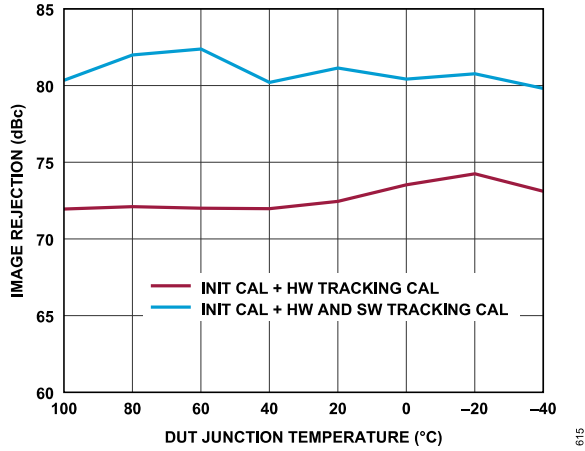

Figure 115. Receiver Image Rejection vs. DUT Junction Temperature (High to Low), Tone 1 Baseband Frequency = -5.1 MHz, Tone 2 Baseband Frequency = 13.9 MHz, ADC = Low Power, $P_{OUT} = -11.1$ dBFS

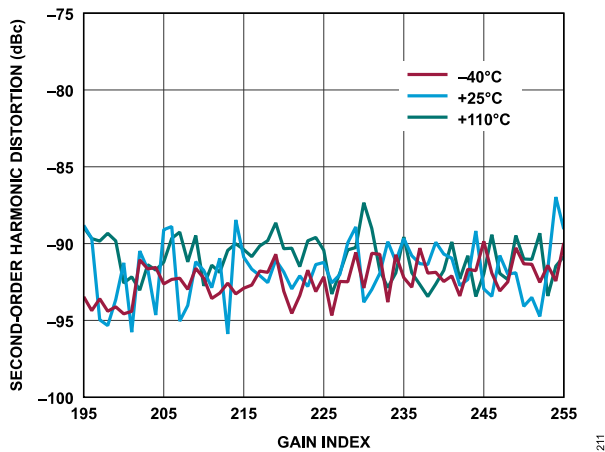

Figure 116. Receiver Second-Order Harmonic Distortion vs. Gain Index, Baseband Frequency = 5.6 MHz, ADC = High Performance

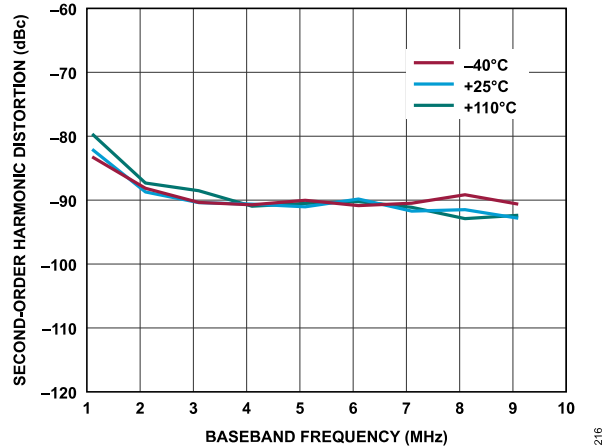

Figure 117. Receiver Second-Order Harmonic Distortion vs. Baseband Frequency, Gain Index = 255, ADC = High Performance

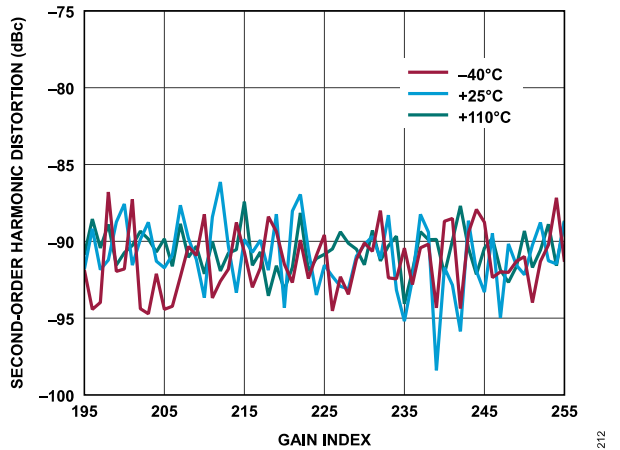

Figure 118. Receiver Second-Order Harmonic Distortion vs. Gain Index, Baseband Frequency = 5.6 MHz, ADC = Low Power

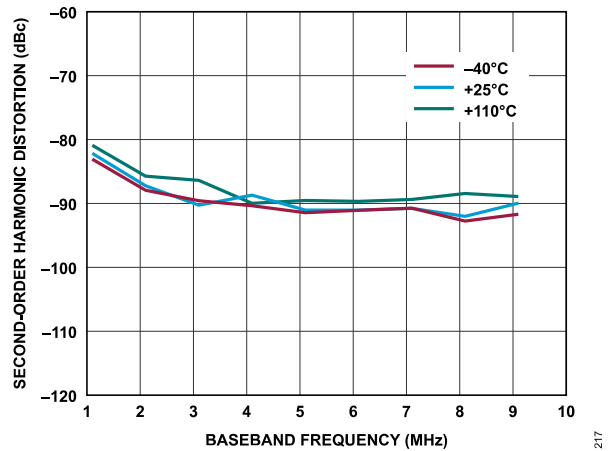

Figure 119. Receiver Second-Order Harmonic Distortion vs. Baseband Frequency, Gain Index = 255, ADC = Low Power

TYPICAL PERFORMANCE CHARACTERISTICS

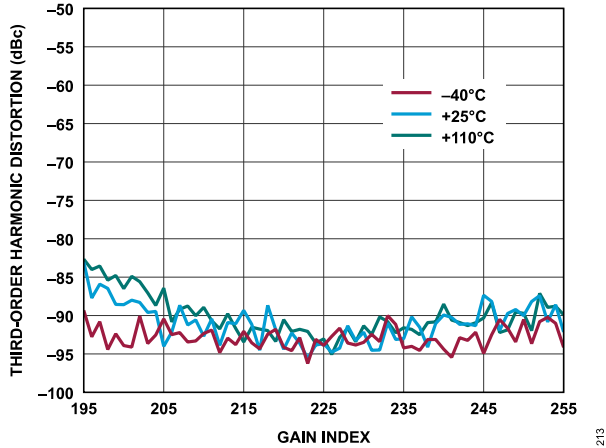

Figure 120. Receiver Third-Order Harmonic Distortion vs. Gain Index, Baseband Frequency = 5.6 MHz, ADC = High Performance

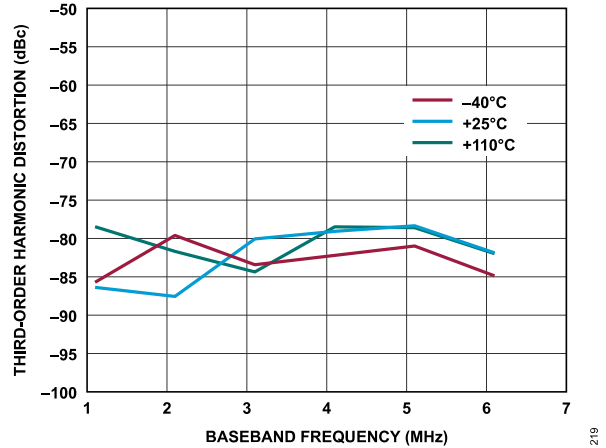

Figure 123. Receiver Third-Order Harmonic Distortion vs. Baseband Frequency, Gain Index = 255, ADC = Low Power

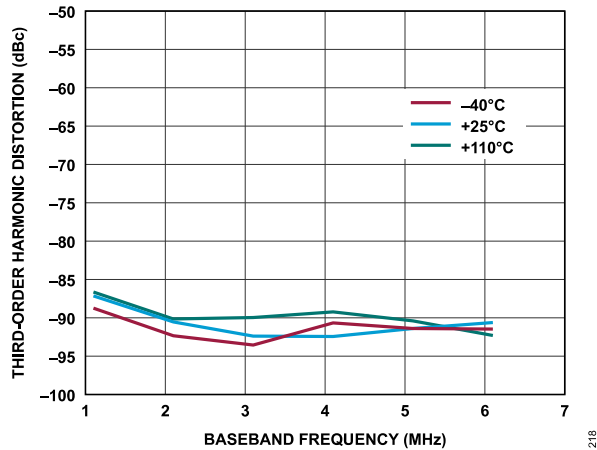

Figure 121. Receiver Third-Order Harmonic Distortion vs. Baseband Frequency, Gain Index = 255, ADC = High Performance

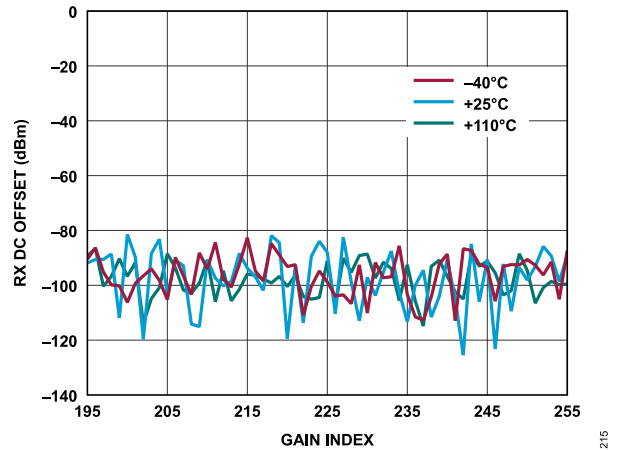

Figure 124. Receiver DC Offset vs. Gain Index, Baseband Frequency = 5.6 MHz, ADC = High Performance

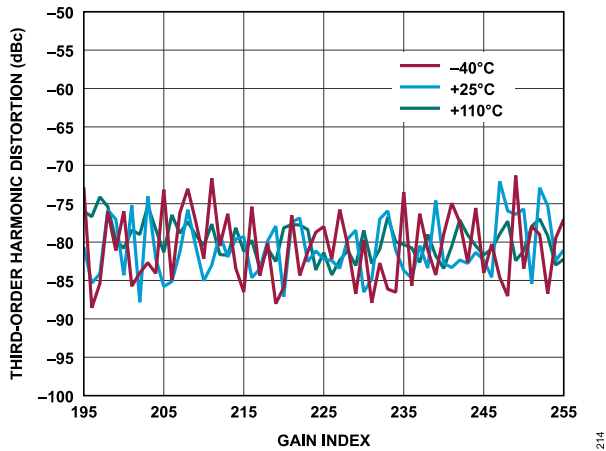

Figure 122. Receiver Third-Order Harmonic Distortion vs. Gain Index, Baseband Frequency = 5.6 MHz, ADC = Low Power

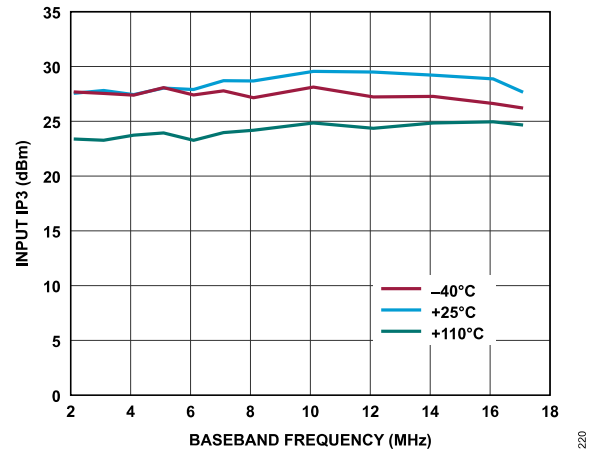

Figure 125. Receiver Input IP3 vs. Baseband Frequency, ADC = High Performance, f_1 = Baseband Frequency, f_2 = Baseband Frequency + 1 MHz, Gain Index = 255

TYPICAL PERFORMANCE CHARACTERISTICS

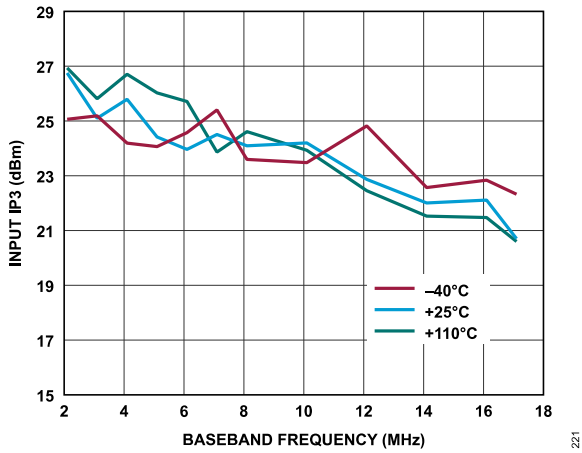

Figure 126. Receiver Input IP3 vs. Baseband Frequency, ADC = Low Power, f1 = Baseband Frequency, f2 = Baseband Frequency + 1 MHz, Gain Index = 255

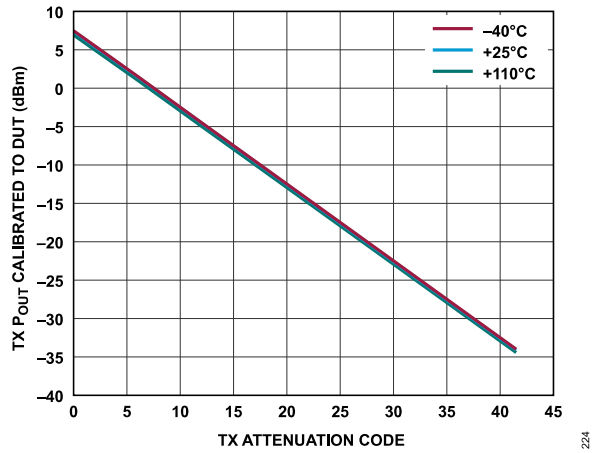

Figure 129. Transmitter Absolute Power vs. Transmitter Attenuation Code, Baseband Frequency = 18 MHz, Backoff = 0.2 dBFS

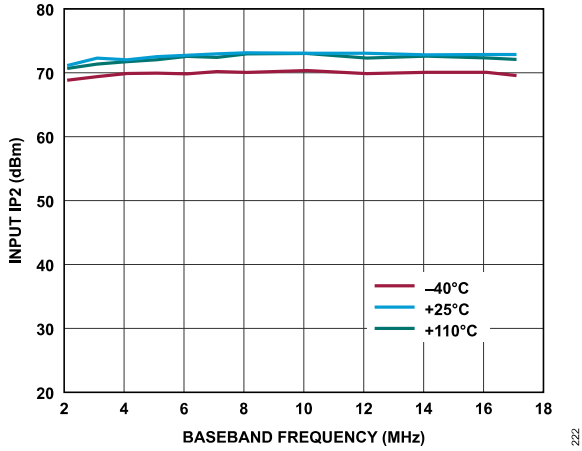

Figure 127. Receiver Input IP2 vs. Baseband Frequency, ADC = High Performance, f1 = Baseband Frequency, f2 = Baseband Frequency + 1 MHz, Gain Index = 255

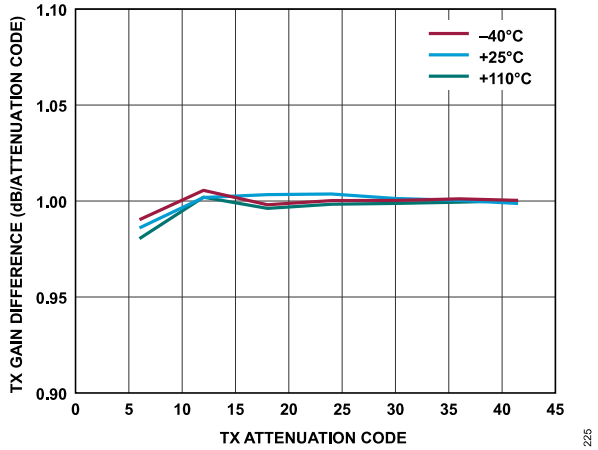

Figure 130. Transmitter Attenuation Delta (Error) vs. Transmitter Attenuation Code, Baseband Frequency = 18 MHz, Backoff = 0.2 dBFS

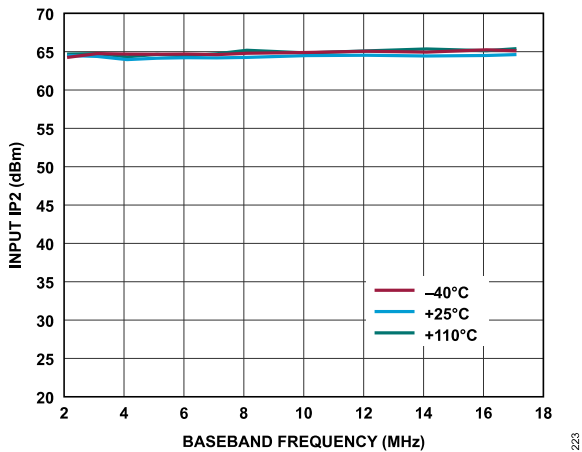

Figure 128. Receiver Input IP2 vs. Baseband Frequency, ADC = Low Power, f1 = Baseband Frequency, f2 = Baseband Frequency + 1 MHz, Gain Index = 255

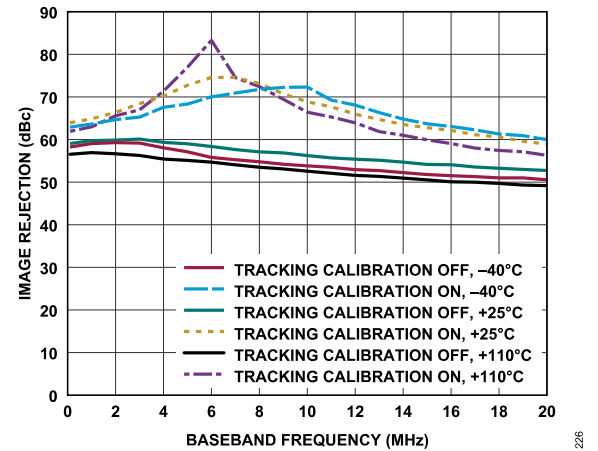

Figure 131. Transmitter Image Rejection vs. Baseband Frequency, Tracking Calibration On vs. Tracking Calibration Off, Transmitter Attenuation Code = 0

TYPICAL PERFORMANCE CHARACTERISTICS

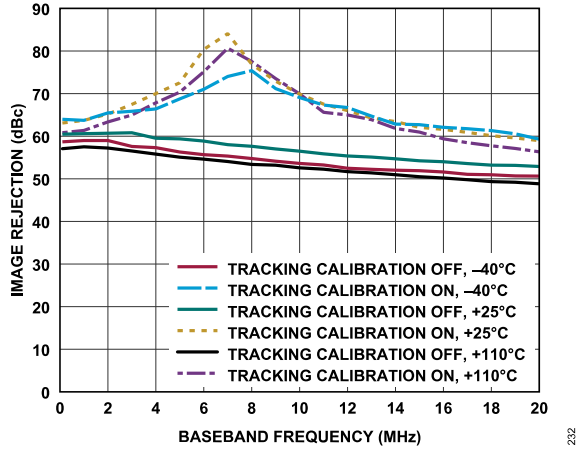

Figure 132. Transmitter Image Rejection vs. Baseband Frequency, Tracking Calibration On vs. Tracking Calibration Off, Transmitter Attenuation Code = 20

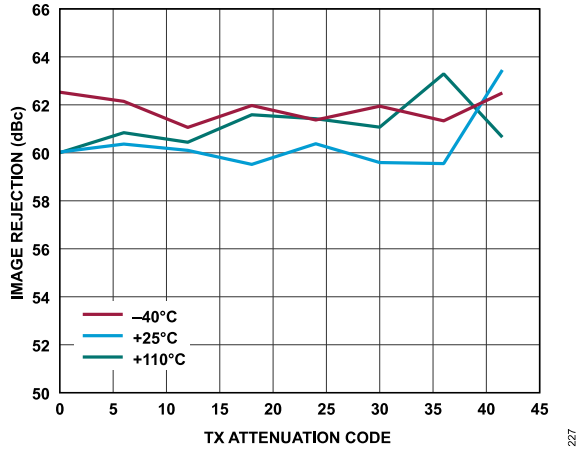

Figure 133. Transmitter Image Rejection vs. Transmitter Attenuation Code, Baseband Frequency = 18 MHz, Backoff = 0.2 dBFS, Initialization Calibration Only

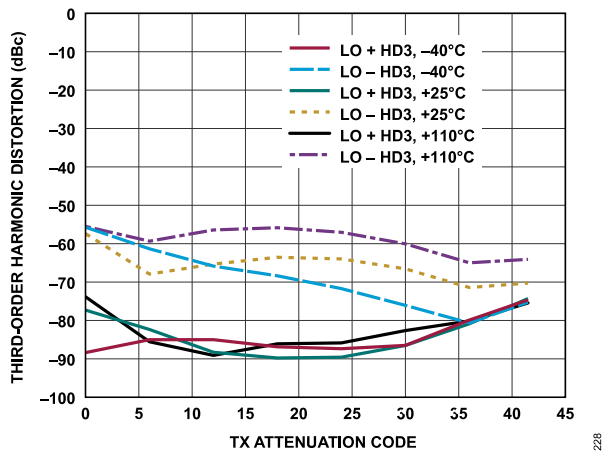

Figure 134. Transmitter Third-Order Harmonic Distortion vs. Transmitter Attenuation Code, Baseband Frequency = 18 MHz, Backoff = 0.2 dBFS

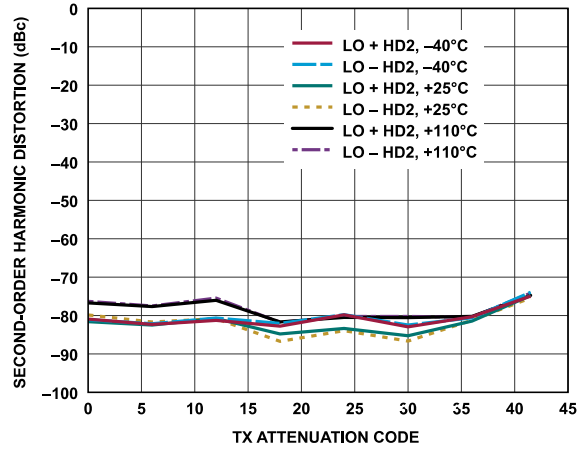

Figure 135. Transmitter Second-Order Harmonic Distortion vs. Transmitter Attenuation Code, Baseband Frequency = 18 MHz, Backoff = 0.2 dBFS

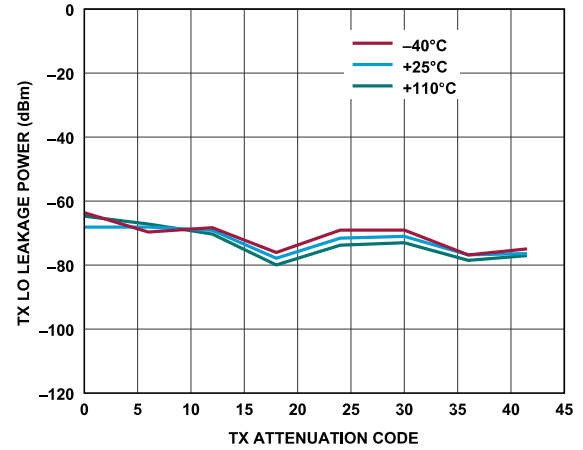

Figure 136. Transmitter LO Leakage Power vs. Transmitter Attenuation Code, Baseband Frequency = 18 MHz, Backoff = 6 dBFS, Initialization Calibration Only

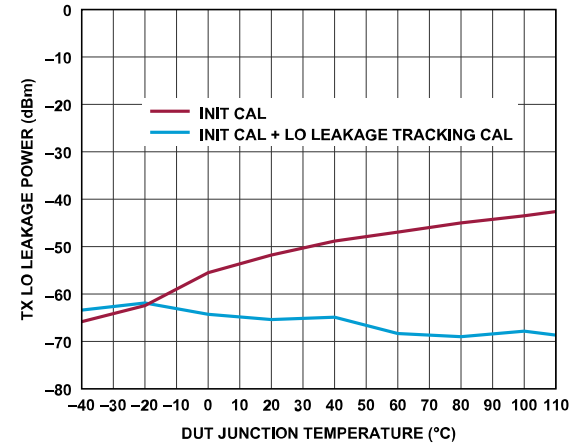

Figure 137. Transmitter LO Leakage Power vs. DUT Junction Temperature (Low to High), Baseband Frequency = 4 MHz, Backoff = 0.5 dBFS, Attenuation Code = 0

TYPICAL PERFORMANCE CHARACTERISTICS

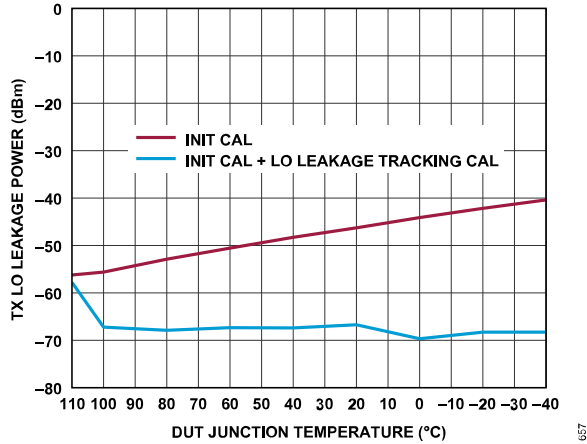

Figure 138. Transmitter LO Leakage Power vs. DUT Junction Temperature (High to Low), Baseband Frequency = 4 MHz, Backoff = 0.5 dBFS, Attenuation Code = 0

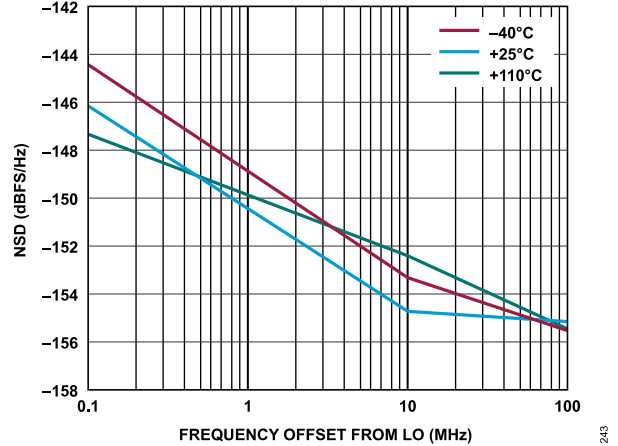

Figure 141. Transmitter NSD vs. Frequency Offset from LO, Baseband Frequency = 5.6 MHz, Transmitter Channel = Ch1

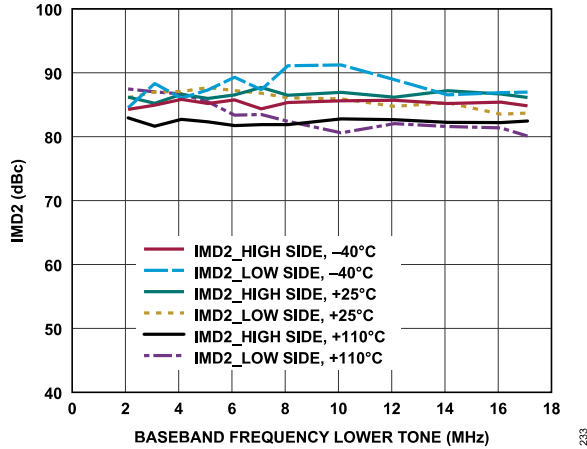

Figure 139. Transmitter IMD2 vs. Baseband Frequency, Transmitter Attenuation Code = 0, f_1 = Baseband Frequency, f_2 = Baseband Frequency + 1 MHz

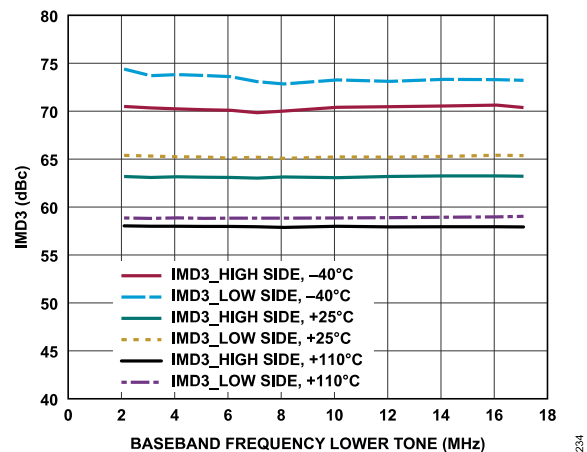

Figure 140. Transmitter IMD3 vs Baseband Frequency, Transmitter Attenuation Code = 0, f_1 = Baseband Frequency, f_2 = Baseband Frequency + 1 MHz

TYPICAL PERFORMANCE CHARACTERISTICS

3500 MHz LO

The temperature settings refer to the die temperature. All LO frequencies set to 3500 MHz, unless otherwise noted.

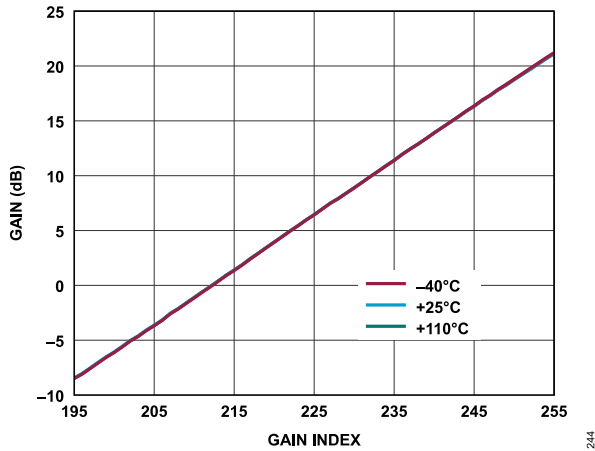

Figure 142. Receiver Absolute Gain (Complex) vs. Gain Index, Baseband Frequency = 5.6 MHz, ADC = High Performance, $P_{OUT} = -9.6$ dBFS

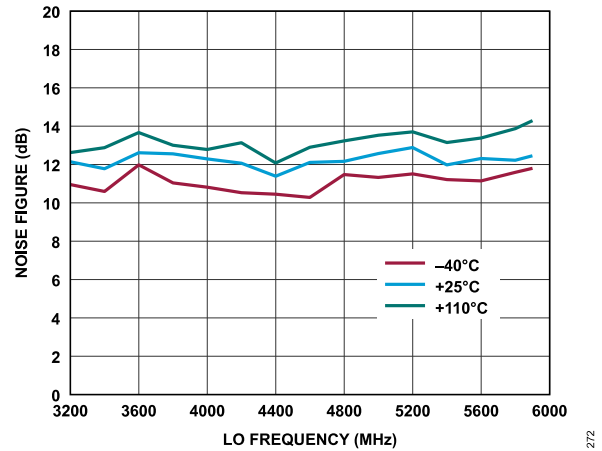

Figure 145. Receiver Noise Figure vs. LO Frequency, Baseband Frequency = 5.6 MHz, ADC = High Performance

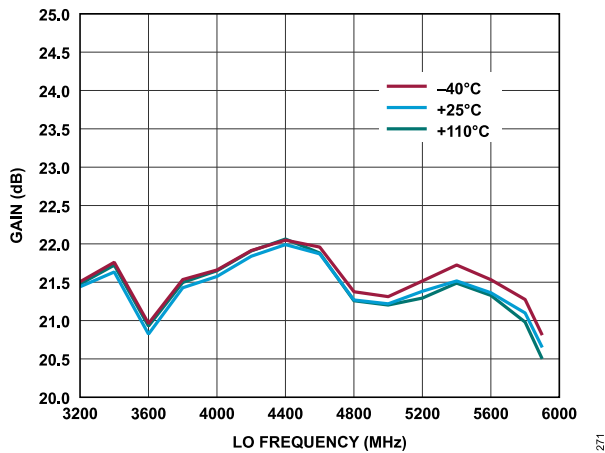

Figure 143. Receiver Absolute Gain (Complex) vs. LO Frequency, Baseband Frequency = 5.6 MHz, ADC = High Performance, $P_{OUT} = -9.6$ dBFS

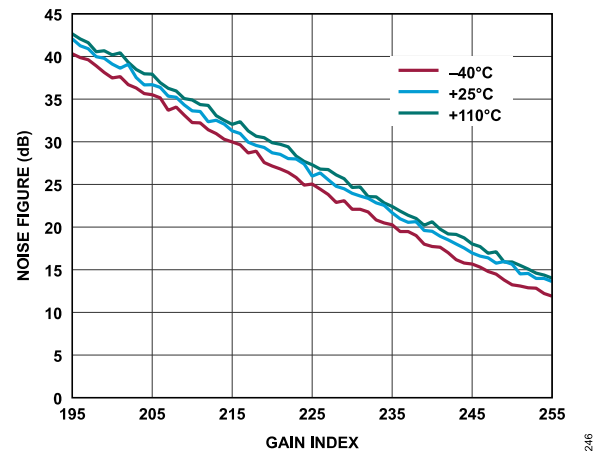

Figure 146. Receiver Noise Figure vs. Gain Index, Baseband Frequency = 5.6 MHz, ADC = Low Power

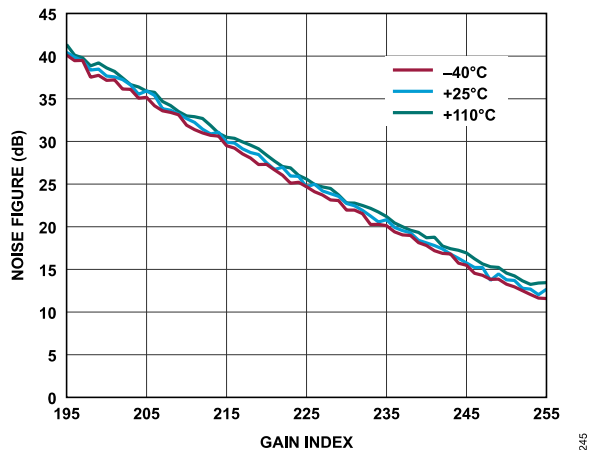

Figure 144. Receiver Noise Figure vs. Gain Index, Baseband Frequency = 5.6 MHz, ADC = High Performance

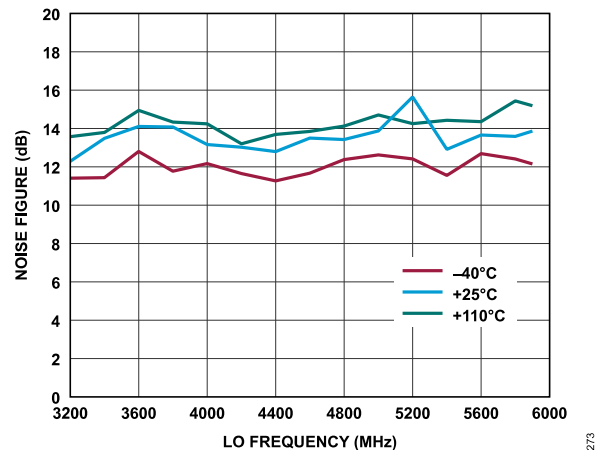

Figure 147. Receiver Noise Figure vs. LO Frequency, Baseband Frequency = 5.6 MHz, ADC = Low Power

TYPICAL PERFORMANCE CHARACTERISTICS

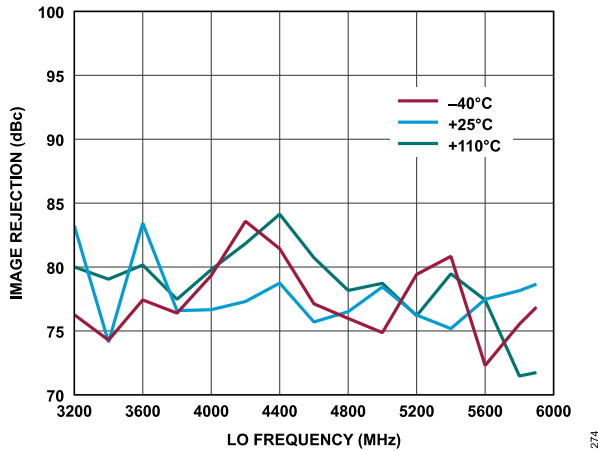

Figure 148. Receiver Image Rejection vs. LO Frequency, Baseband Frequency = 5.6 MHz, ADC = High Performance, Initialization Calibration and Hardware Tracking Calibration Only

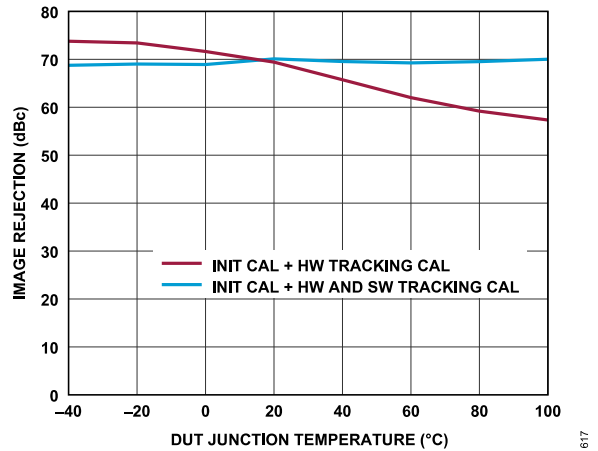

Figure 151. Receiver Image Rejection vs. DUT Junction Temperature (Low to High), Tone 1 Baseband Frequency = -5.1 MHz, Tone 2 Baseband Frequency = 13.9 MHz, ADC = Low Power, $P_{OUT} = -11.1$ dBFS

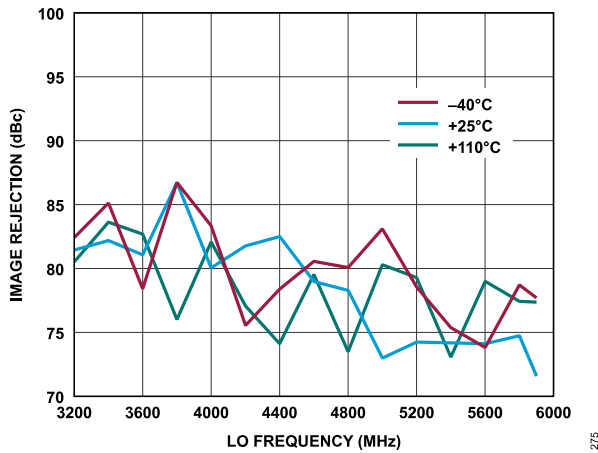

Figure 149. Receiver Image Rejection vs. LO Frequency, Baseband Frequency = 5.6 MHz, ADC = Low Power, Initialization Calibration and Hardware Tracking Calibration Only

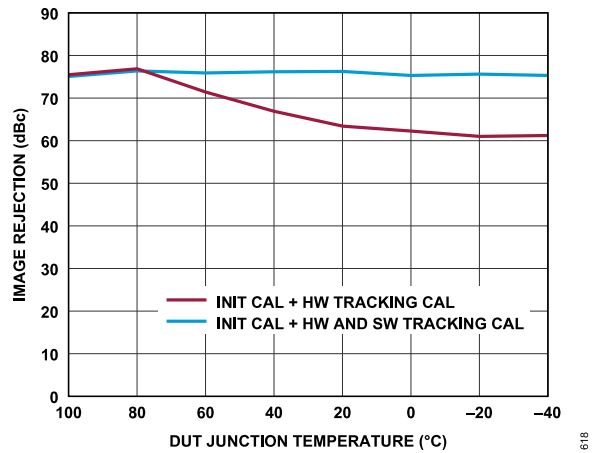

Figure 152. Receiver Image Rejection vs. DUT Junction Temperature (High to Low), Tone 1 Baseband Frequency = -5.1 MHz, Tone 2 Baseband Frequency = 13.9 MHz, ADC = High Performance, $P_{OUT} = -11.1$ dBFS

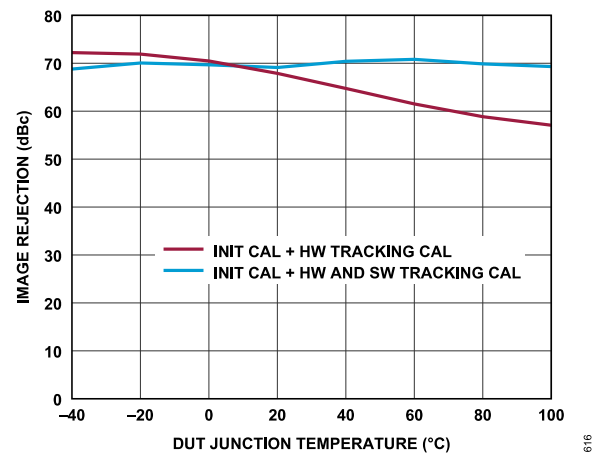

Figure 150. Receiver Image Rejection vs. DUT Junction Temperature (Low to High), Tone 1 Baseband Frequency = -5.1 MHz, Tone 2 Baseband Frequency = 13.9 MHz, ADC = High Performance, $P_{OUT} = -11.1$ dBFS

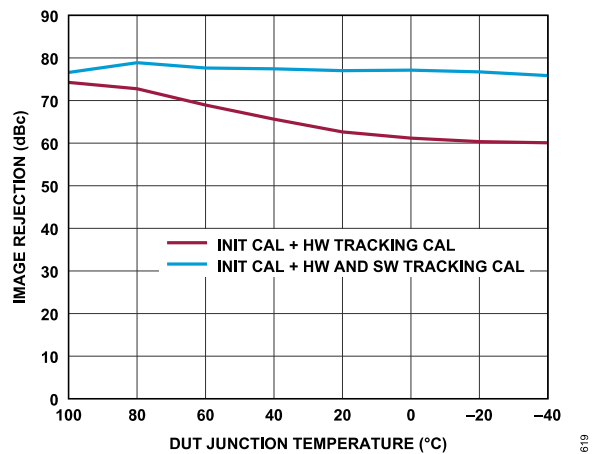

Figure 153. Receiver Image Rejection vs. DUT Junction Temperature (High to Low), Tone 1 Baseband Frequency = -5.1 MHz, Tone 2 Baseband Frequency = 13.9 MHz, ADC = Low Power, $P_{OUT} = -11.1$ dBFS

TYPICAL PERFORMANCE CHARACTERISTICS

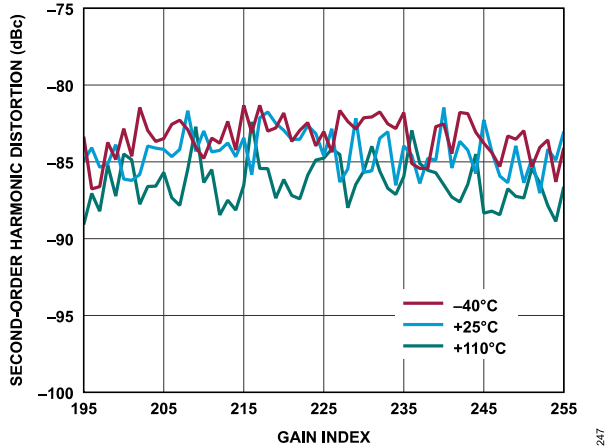

Figure 154. Receiver Second-Order Harmonic Distortion vs. Gain Index, Baseband Frequency = 5.6 MHz, ADC = High Performance

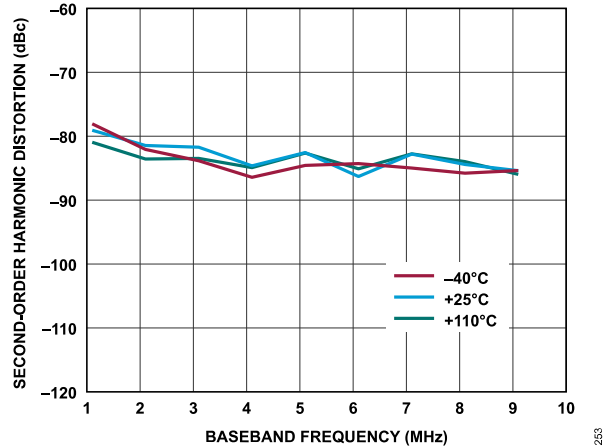

Figure 157. Receiver Second-Order Harmonic Distortion vs. Baseband Frequency, Gain Index = 255, ADC = Low Power

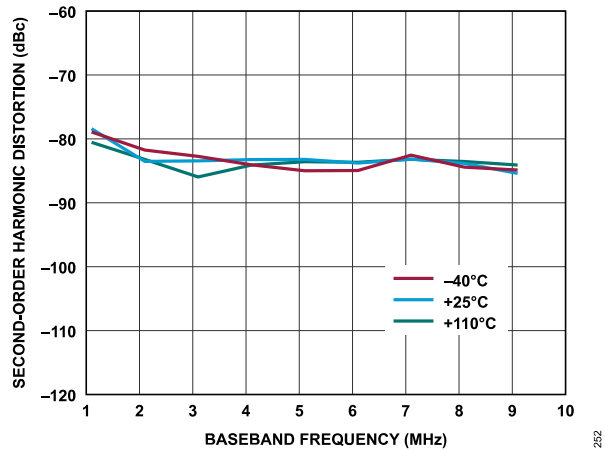

Figure 155. Receiver Second-Order Harmonic Distortion vs. Baseband Frequency, Gain Index = 255, ADC = High Performance

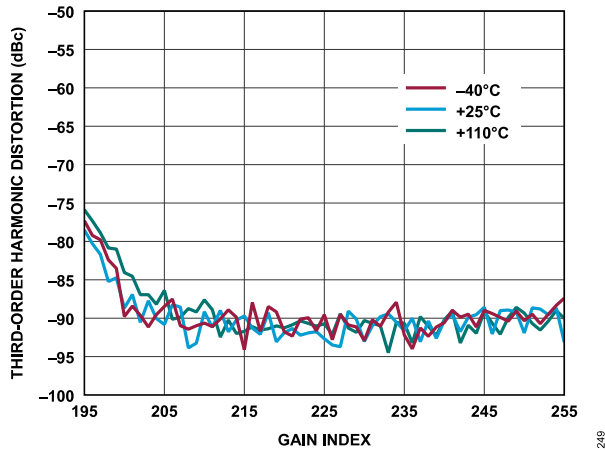

Figure 158. Receiver Third-Order Harmonic Distortion vs. Gain Index, Baseband Frequency = 5.6 MHz, ADC = High Performance

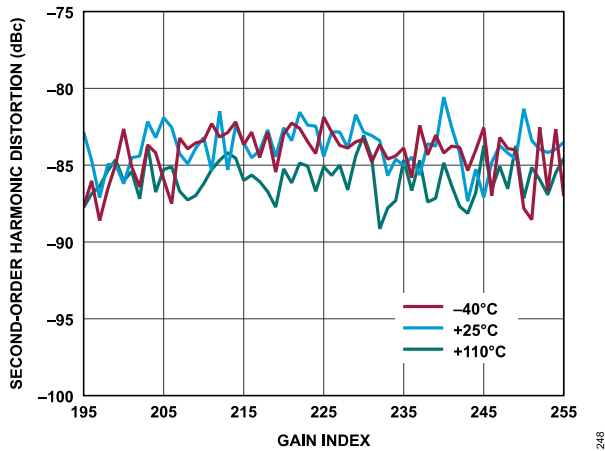

Figure 156. Receiver Second-Order Harmonic Distortion vs. Gain Index, Baseband Frequency = 5.6 MHz, ADC = Low Power

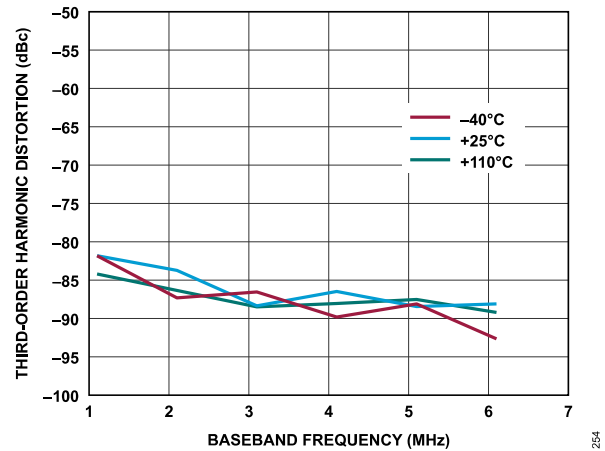

Figure 159. Receiver Third-Order Harmonic Distortion vs. Baseband Frequency, Gain Index = 255, ADC = High Performance

TYPICAL PERFORMANCE CHARACTERISTICS

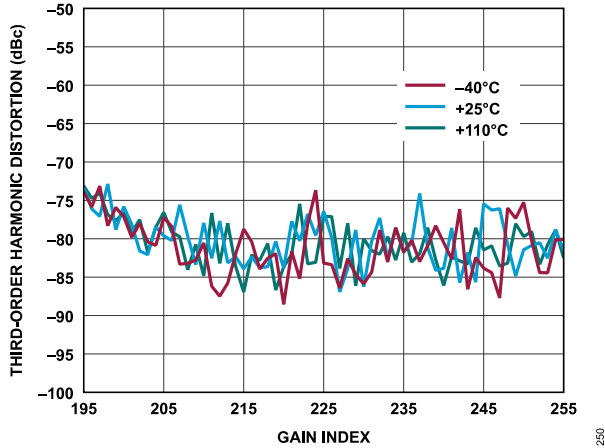

Figure 160. Receiver Third-Order Harmonic Distortion vs. Gain Index, Baseband Frequency = 5.6 MHz, ADC = Low Power

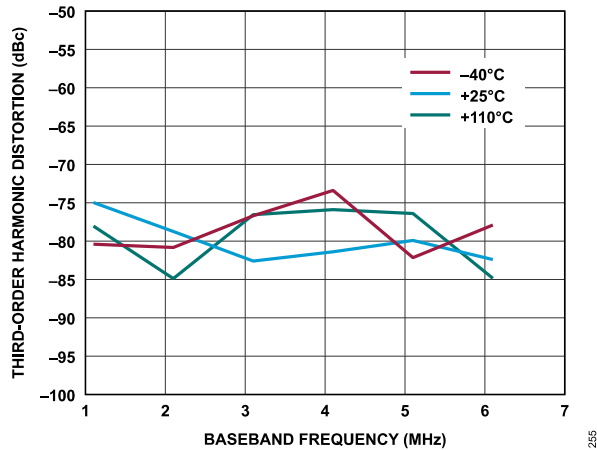

Figure 161. Receiver Third-Order Harmonic Distortion vs. Baseband Frequency, Gain index = 255, ADC = Low Power

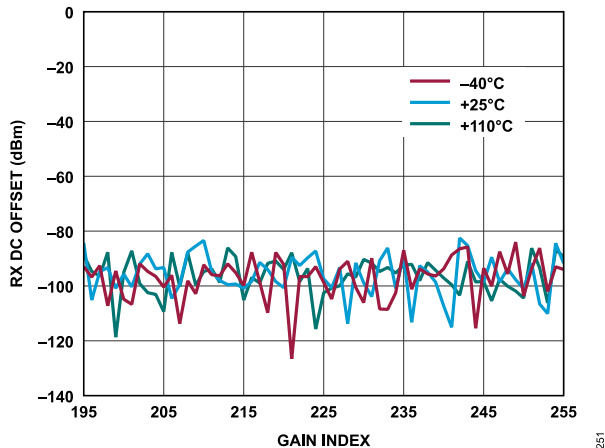

Figure 162. Receiver DC Offset vs. Gain Index, Baseband Frequency = 5.6 MHz, ADC = High Performance

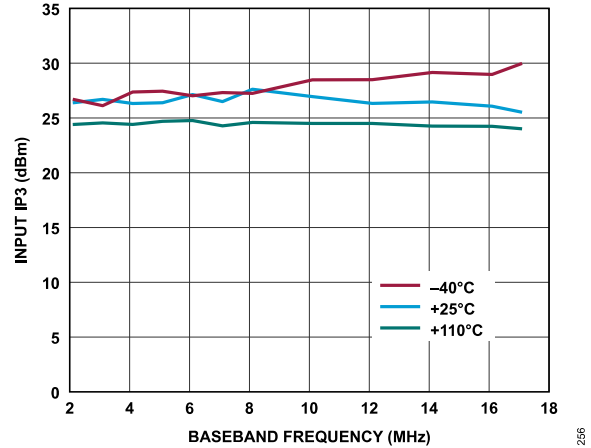

Figure 163. Receiver Input IP3 vs. Baseband Frequency, ADC = High Performance, f_1 = Baseband Frequency, f_2 = Baseband Frequency + 1 MHz, Gain Index = 255

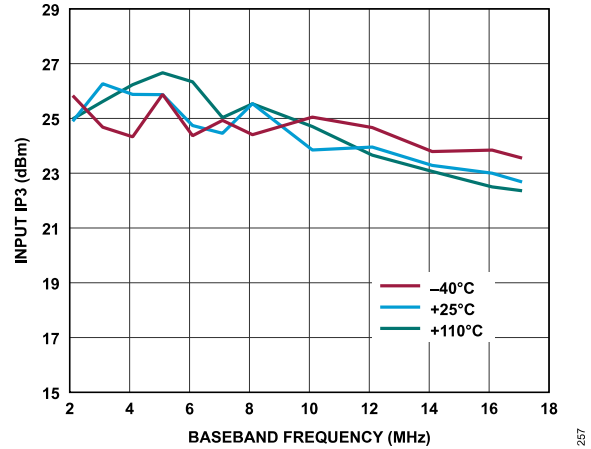

Figure 164. Receiver Input IP3 vs. Baseband Frequency, ADC = Low Power, f_1 = Baseband Frequency, f_2 = Baseband Frequency + 1 MHz, Gain Index = 255

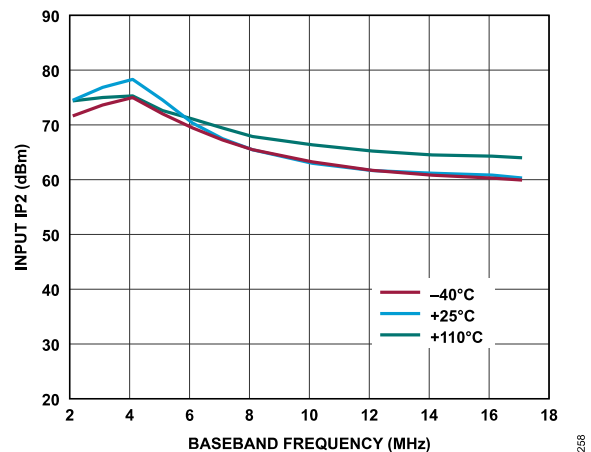

Figure 165. Receiver Input IP2 vs. Baseband Frequency, ADC = High Performance, f_1 = Baseband Frequency, f_2 = Baseband Frequency + 1 MHz, Gain Index = 255

TYPICAL PERFORMANCE CHARACTERISTICS

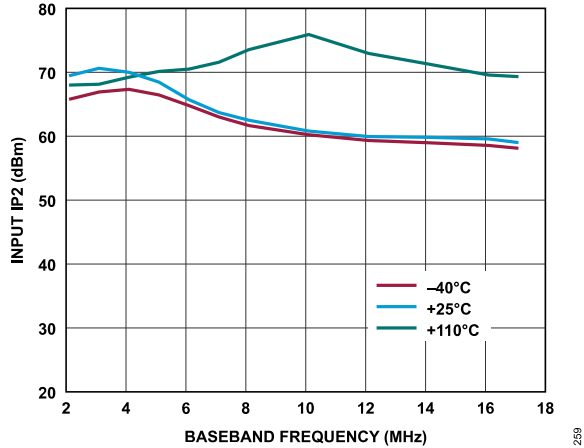

Figure 166. Receiver Input IP2 vs. Baseband Frequency, ADC = Low Power, f1 = Baseband Frequency, f2 = Baseband Frequency + 1 MHz, Gain Index = 255

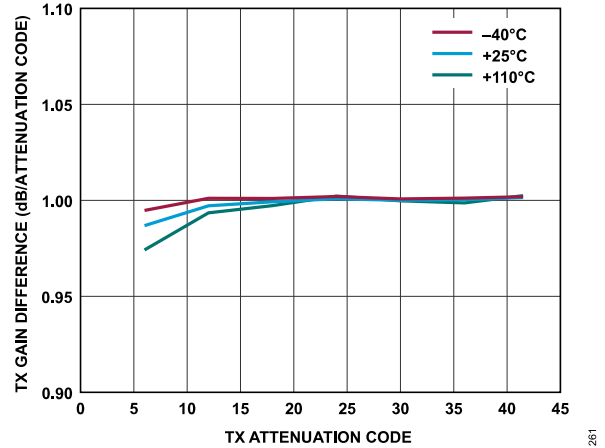

Figure 169. Transmitter Attenuation Delta (Error) vs. Transmitter Attenuation Code, Baseband Frequency = 18 MHz, Backoff = 0.2 dBFS

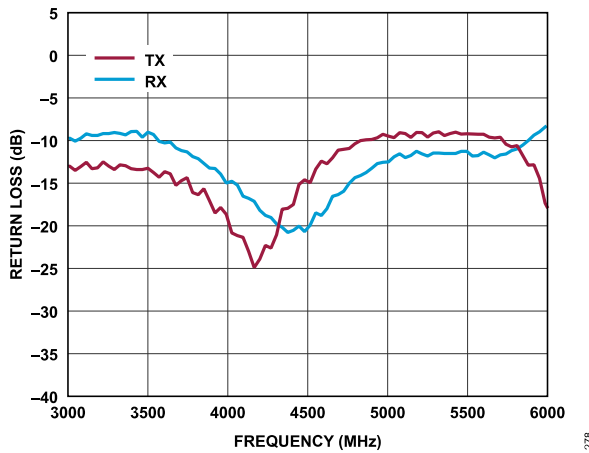

Figure 167. Receiver and Transmitter Return Loss vs. Frequency (For LO = 3 GHz to 6 GHz)

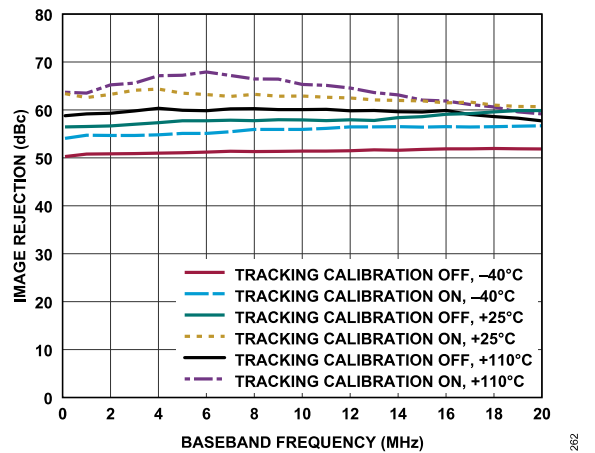

Figure 170. Transmitter Image Rejection vs. Baseband Frequency, Tracking Calibration On vs. Tracking Calibration Off, Transmitter Attenuation Code = 0

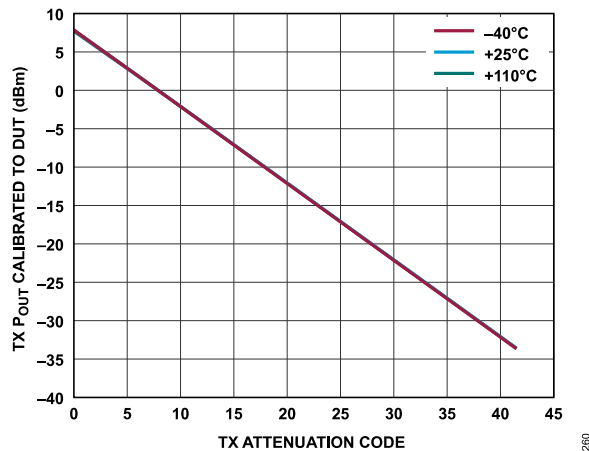

Figure 168. Transmitter Absolute Power vs. Transmitter Attenuation Code, Baseband Frequency = 18 MHz, Backoff = 0.2 dBFS

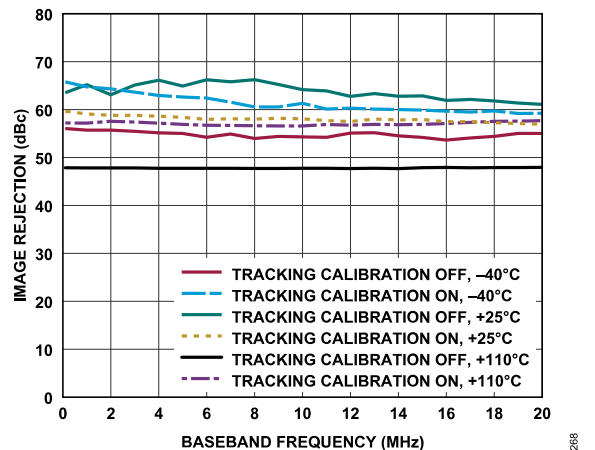

Figure 171. Transmitter Image Rejection vs. Baseband Frequency, Tracking Calibration On vs. Tracking Calibration Off, Transmitter Attenuation Code = 20

TYPICAL PERFORMANCE CHARACTERISTICS

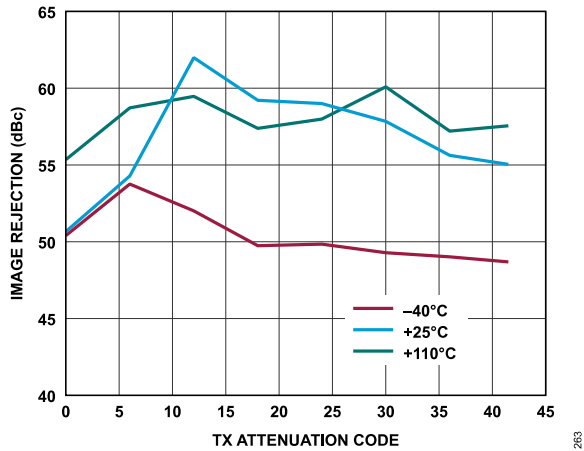

Figure 172. Transmitter Image Rejection vs. Transmitter Attenuation Code, Baseband Frequency = 18 MHz, Backoff = 0.2 dBFS, Initialization Calibration Only

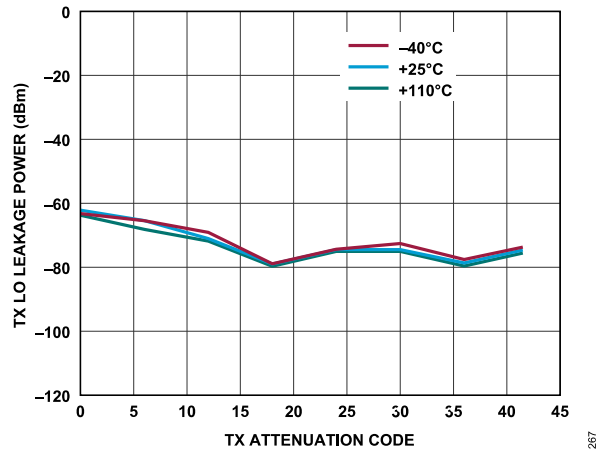

Figure 175. Transmitter LO Leakage Power vs. Transmitter Attenuation Code, Baseband Frequency = 18 MHz, Backoff = 6 dBFS, Initialization Calibration Only

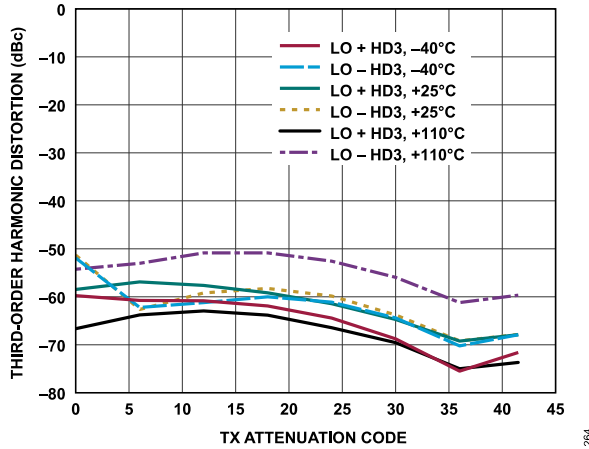

Figure 173. Transmitter Third-Order Harmonic Distortion vs. Transmitter Attenuation Code, Baseband Frequency = 18 MHz, Backoff = 0.2 dBFS

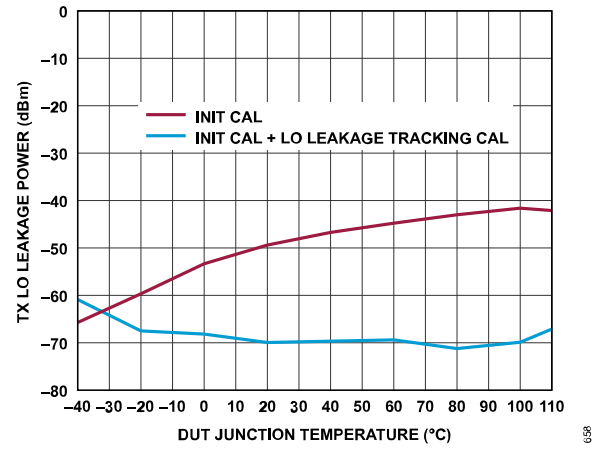

Figure 176. Transmitter LO Leakage Power vs. DUT Junction Temperature (Low to High), Baseband Frequency = 4 MHz, Backoff = 0.5 dBFS, Attenuation Code = 0

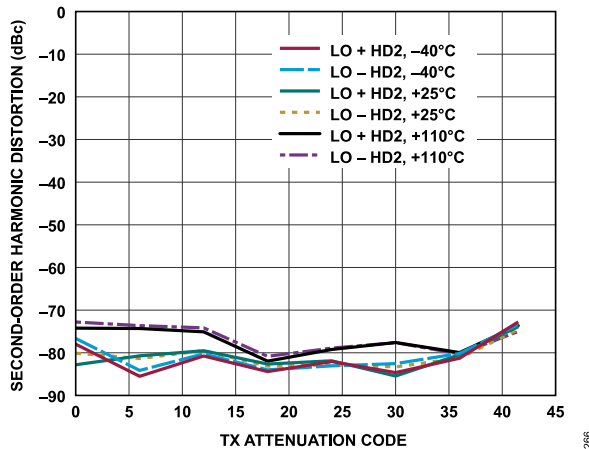

Figure 174. Transmitter Second-Order Harmonic Distortion vs. Transmitter Attenuation Code, Baseband Frequency = 18 MHz, Backoff = 0.2 dBFS

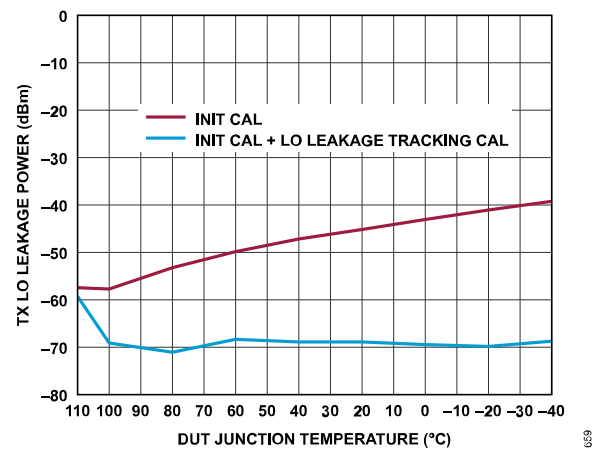

Figure 177. Transmitter LO Leakage Power vs. DUT Junction Temperature (High to Low), Baseband Frequency = 4 MHz, Backoff = 0.5 dBFS, Attenuation Code = 0

TYPICAL PERFORMANCE CHARACTERISTICS

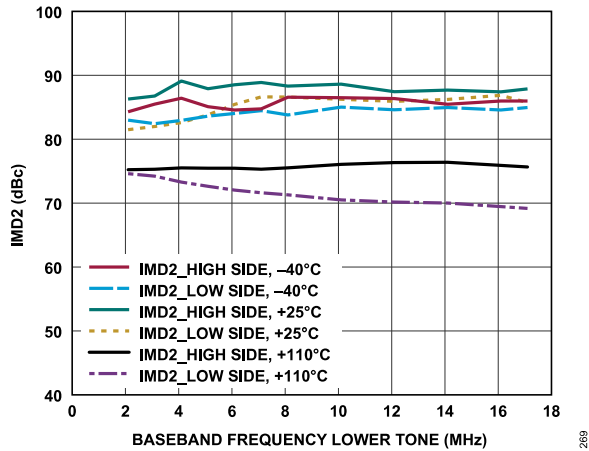

Figure 178. Transmitter IMD2 vs. Baseband Frequency, Transmitter Attenuation Code = 0, f_1 = Baseband Frequency, f_2 = Baseband Frequency + 1 MHz

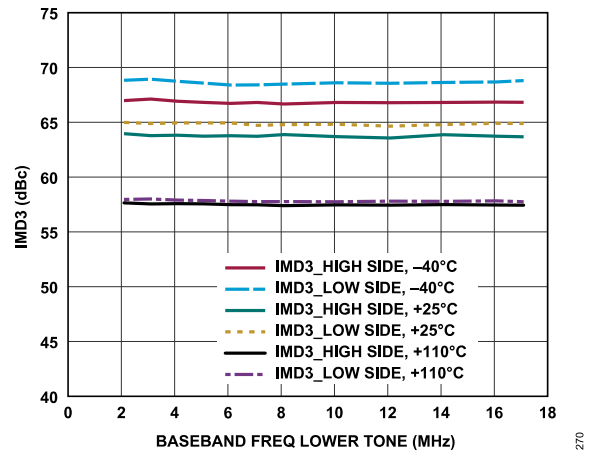

Figure 179. Transmitter IMD3 vs. Baseband Frequency, Transmitter Attenuation Code = 0, f_1 = Baseband Frequency, f_2 = Baseband Frequency + 1 MHz

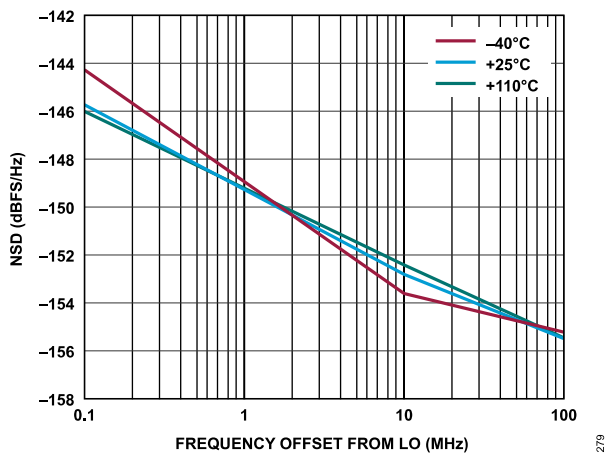

Figure 180. Transmitter NSD vs. Frequency Offset from LO, Baseband Frequency = 5.6 MHz, Transmitter Channel = Ch1

TYPICAL PERFORMANCE CHARACTERISTICS

5800 MHz LO

The temperature settings refer to the die temperature. All LO frequencies set to 5800 MHz, unless otherwise noted.

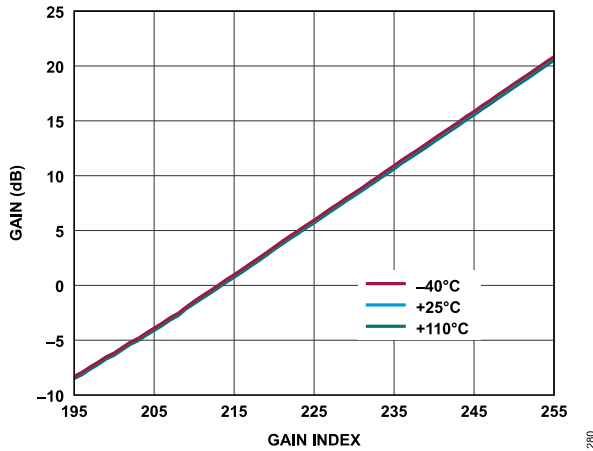

Figure 181. Receiver Absolute Gain (Complex) vs. Gain Index, Baseband Frequency = 5.6 MHz, ADC = High Performance, $P_{OUT} = -9.6$ dBFS

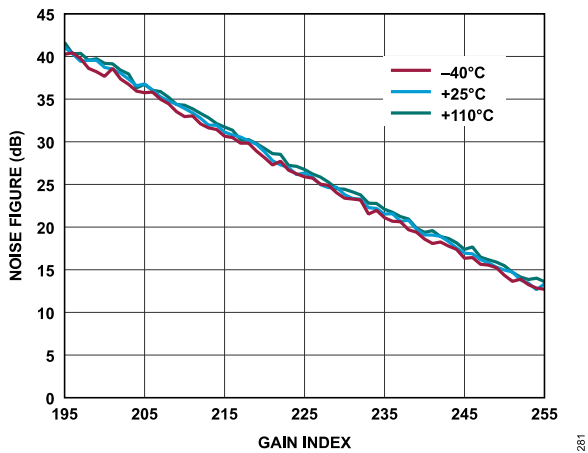

Figure 182. Receiver Noise Figure vs. Gain Index, Baseband Frequency = 5.6 MHz, ADC = High Performance

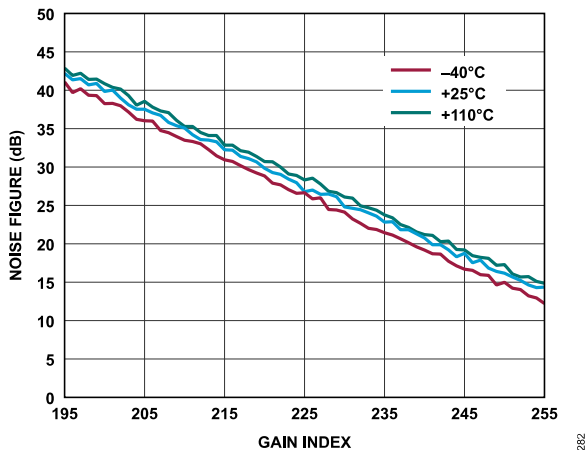

Figure 183. Receiver Noise Figure vs. Gain Index, Baseband Frequency = 5.6 MHz, ADC = Low Power

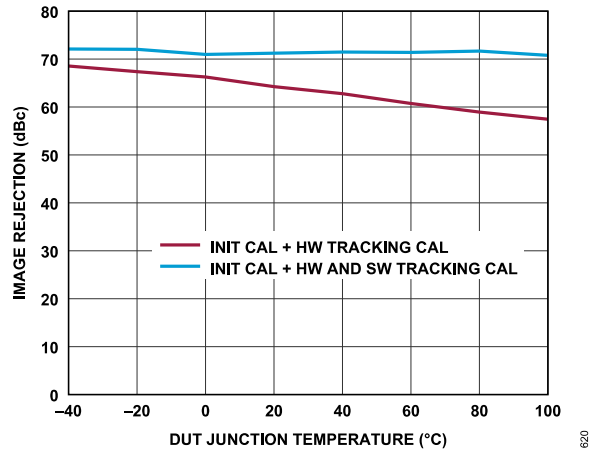

Figure 184. Receiver Image Rejection vs. DUT Junction Temperature (Low to High), Tone 1 Baseband Frequency = -5.1 MHz, Tone 2 Baseband Frequency = 13.9 MHz, ADC = High Performance, $P_{OUT} = -11.1$ dBFS

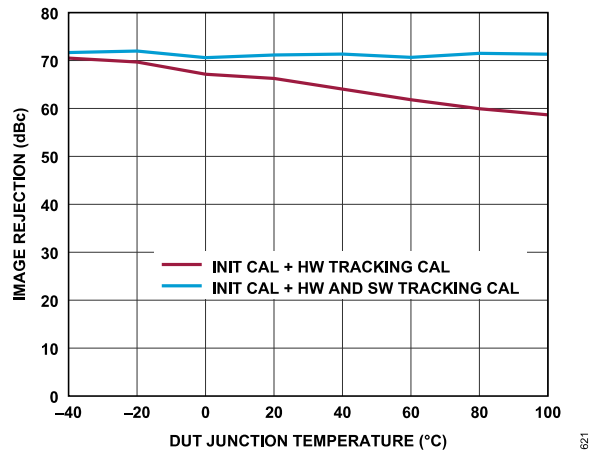

Figure 185. Receiver Image Rejection vs. DUT Junction Temperature (Low to High), Tone 1 Baseband Frequency = -5.1 MHz, Tone 2 Baseband Frequency = 13.9 MHz, ADC = Low Power, $P_{OUT} = -11.1$ dBFS

TYPICAL PERFORMANCE CHARACTERISTICS

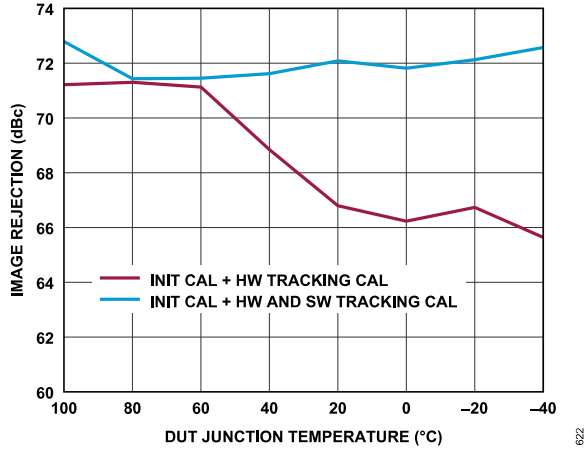

Figure 186. Receiver Image Rejection vs. DUT Junction Temperature (High to Low), Tone 1 Baseband Frequency = -5.1 MHz, Tone 2 Baseband Frequency = 13.9 MHz, ADC = High Performance, $P_{OUT} = -11.1$ dBFS

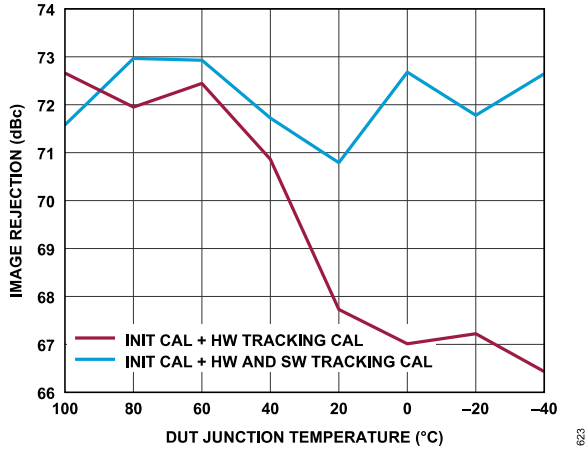

Figure 187. Receiver Image Rejection vs. DUT Junction Temperature (High to Low), Tone 1 Baseband Frequency = -5.1 MHz, Tone 2 Baseband Frequency = 13.9 MHz, ADC = Low Power, $P_{OUT} = -11.1$ dBFS

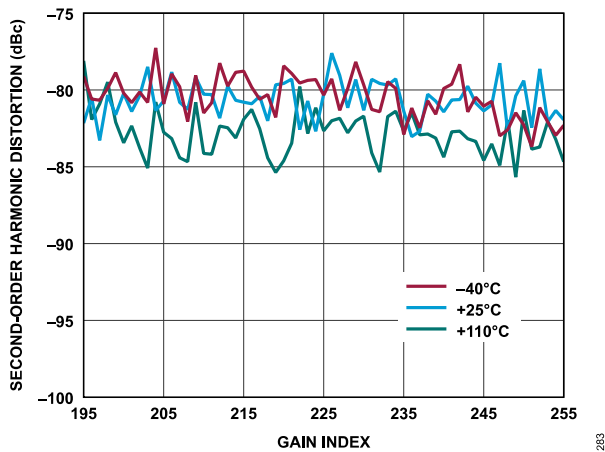

Figure 188. Receiver Second-Order Harmonic Distortion vs. Gain Index, Baseband Frequency = 5.6 MHz, ADC = High Performance

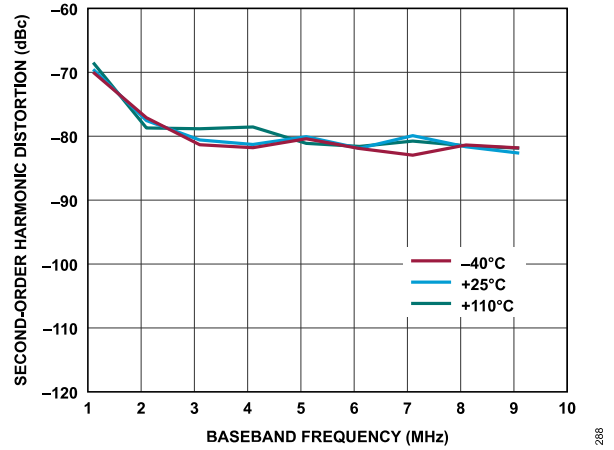

Figure 189. Receiver Second-Order Harmonic Distortion vs. Baseband Frequency, Gain Index = 255, ADC = High Performance

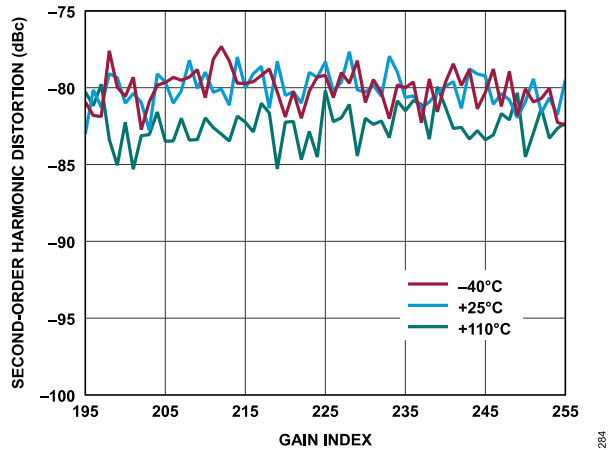

Figure 190. Receiver Second-Order Harmonic Distortion vs. Gain Index, Baseband Frequency = 5.6 MHz, ADC = Low Power

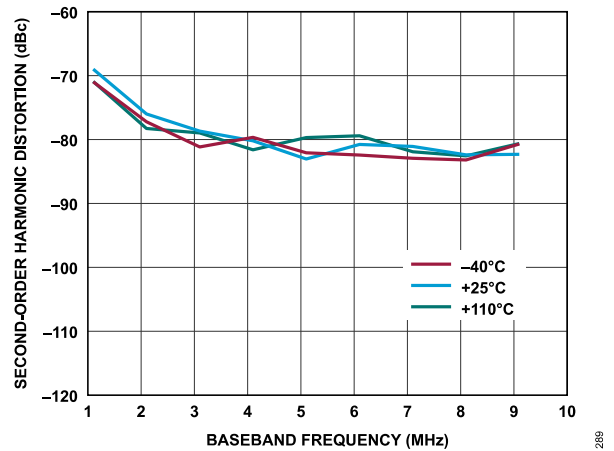

Figure 191. Receiver Second-Order Harmonic Distortion vs. Baseband Frequency, Gain Index = 255, ADC = Low Power

TYPICAL PERFORMANCE CHARACTERISTICS

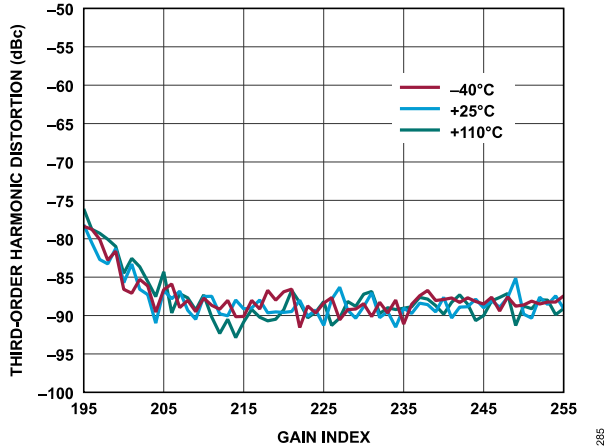

Figure 192. Receiver Third-Order Harmonic Distortion vs. Gain Index, Baseband Frequency = 5.6 MHz, ADC = High Performance

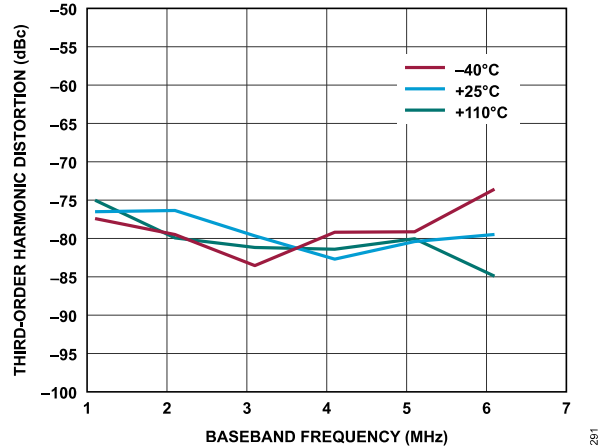

Figure 195. Receiver Third-Order Harmonic Distortion vs. Baseband Frequency, Gain index = 255, ADC = Low Power

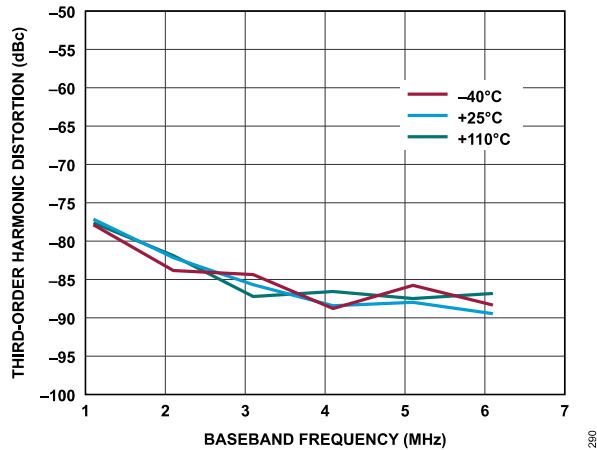

Figure 193. Receiver Third-Order Harmonic Distortion vs. Baseband Frequency, Gain Index = 255, ADC = High Performance

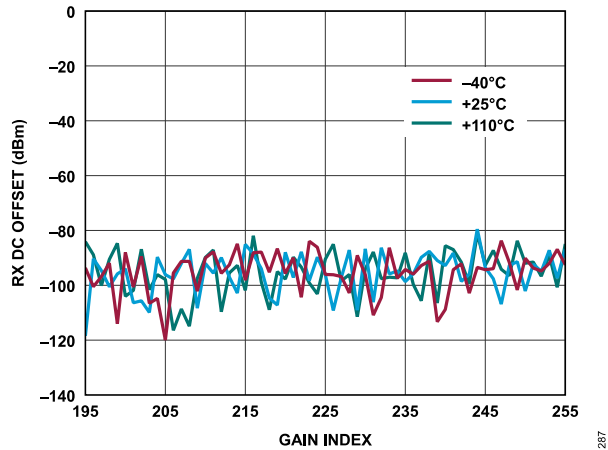

Figure 196. Receiver DC Offset vs. Gain Index, Baseband Frequency = 5.6 MHz, ADC = High Performance

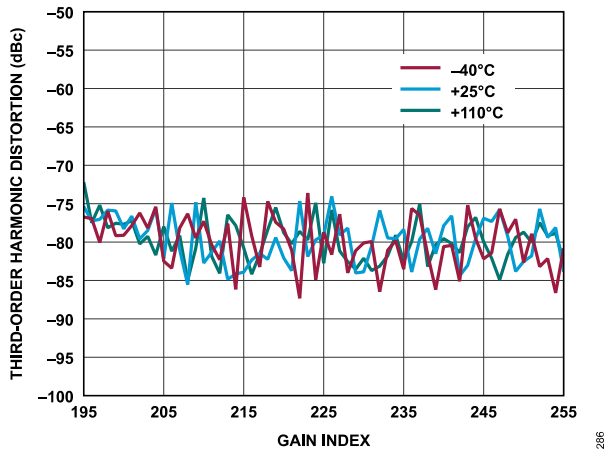

Figure 194. Receiver Third-Order Harmonic Distortion vs. Gain Index, Baseband Frequency = 5.6 MHz, ADC = Low Power

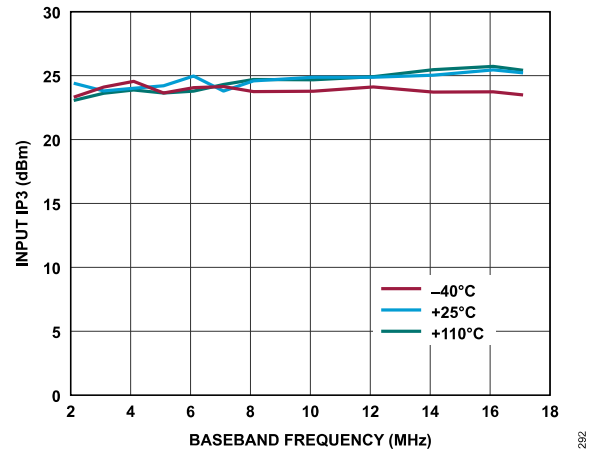

Figure 197. Receiver Input IP3 vs. Baseband Frequency, ADC = High Performance, f_1 = Baseband Frequency, f_2 = Baseband Frequency + 1 MHz, Gain Index = 255

TYPICAL PERFORMANCE CHARACTERISTICS

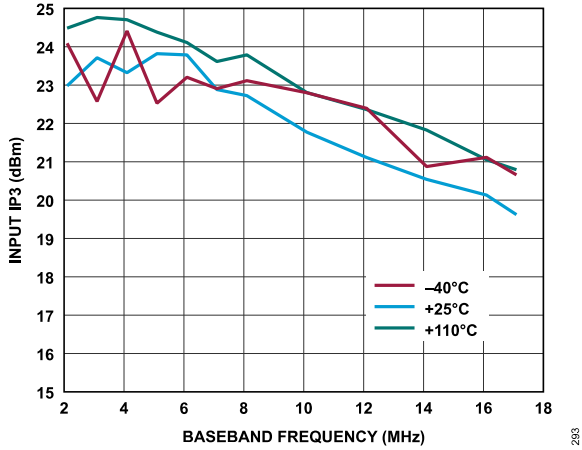

Figure 198. Receiver Input IP3 vs. Baseband Frequency, ADC = Low Power, f_1 = Baseband Frequency, f_2 = Baseband Frequency + 1 MHz, Gain Index = 255

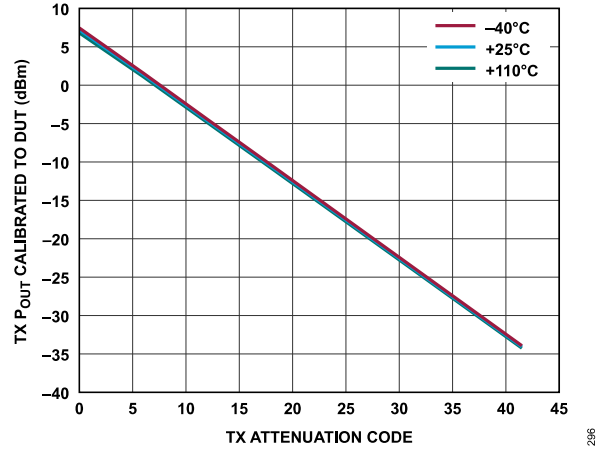

Figure 201. Transmitter Absolute Power vs. Transmitter Attenuation Code, Baseband Frequency = 18 MHz, Backoff = 0.2 dBFS

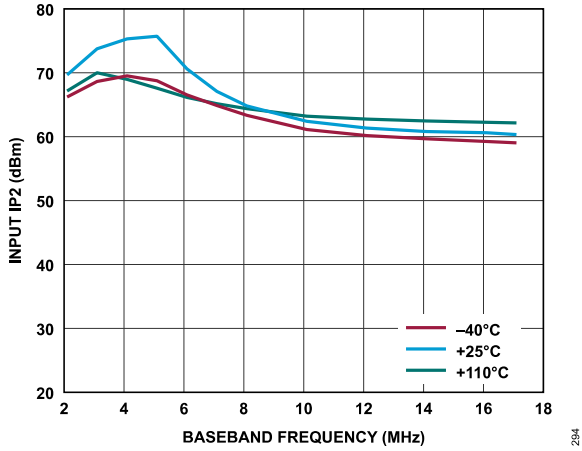

Figure 199. Receiver Input IP2 vs. Baseband Frequency, ADC = High Performance, f_1 = Baseband Frequency, f_2 = Baseband Frequency + 1 MHz, Gain Index = 255

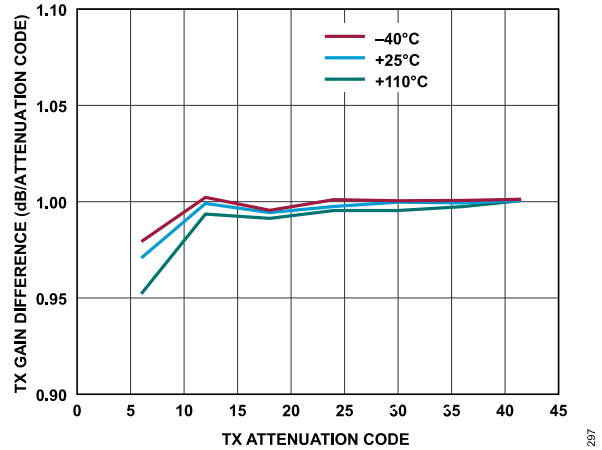

Figure 202. Transmitter Attenuation Delta (Error) vs. Transmitter Attenuation Code, Baseband Frequency = 18 MHz, Backoff = 0.2 dBFS

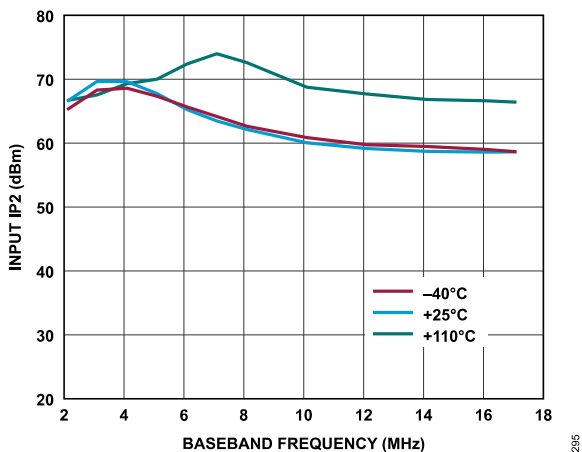

Figure 200. Receiver Input IP2 vs. Baseband Frequency, ADC = Low Power, f_1 = Baseband Frequency, f_2 = Baseband Frequency + 1 MHz, Gain Index = 255

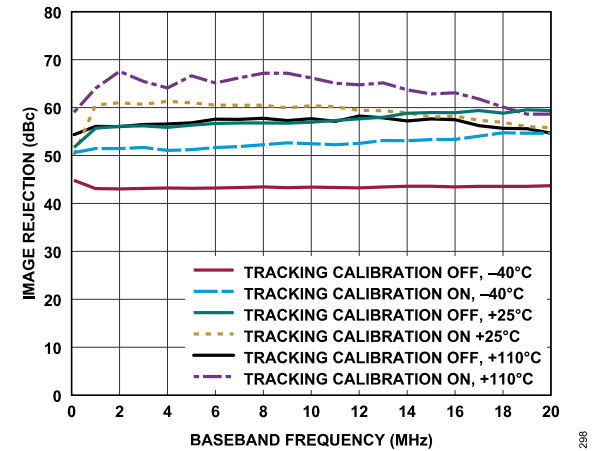

Figure 203. Transmitter Image Rejection vs. Baseband Frequency, Tracking Calibration On vs. Tracking Calibration Off, Transmitter Attenuation Code = 0

TYPICAL PERFORMANCE CHARACTERISTICS

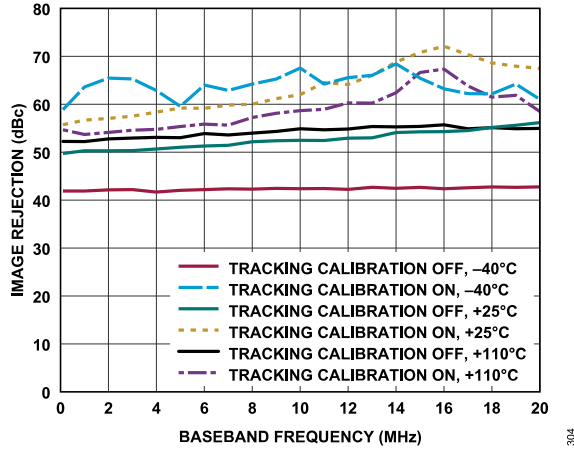

Figure 204. Transmitter Image Rejection vs. Baseband Frequency, Tracking Calibration On vs. Tracking Calibration Off, Transmitter Attenuation Code = 20

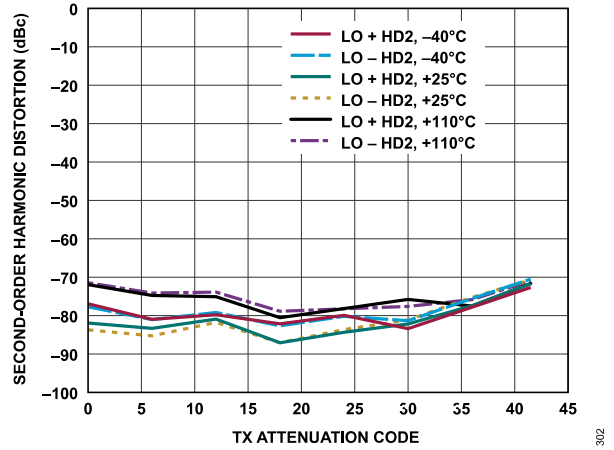

Figure 207. Transmitter Second-Order Harmonic Distortion vs. Transmitter Attenuation Code, Baseband Frequency = 18 MHz, Backoff = 0.2 dBFS

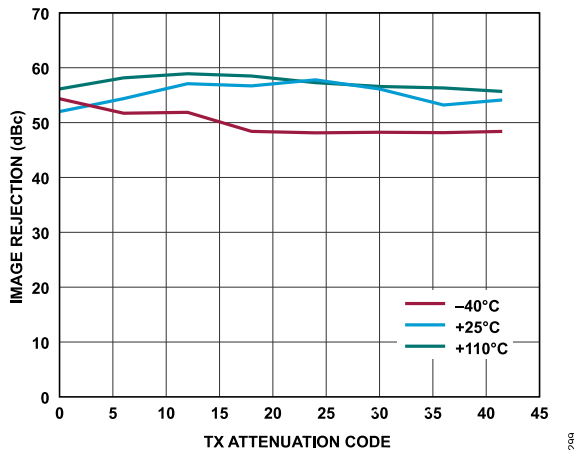

Figure 205. Transmitter Image Rejection vs. Transmitter Attenuation Code, Baseband Frequency = 18 MHz, Backoff = 0.2 dBFS, Initialization Calibration Only

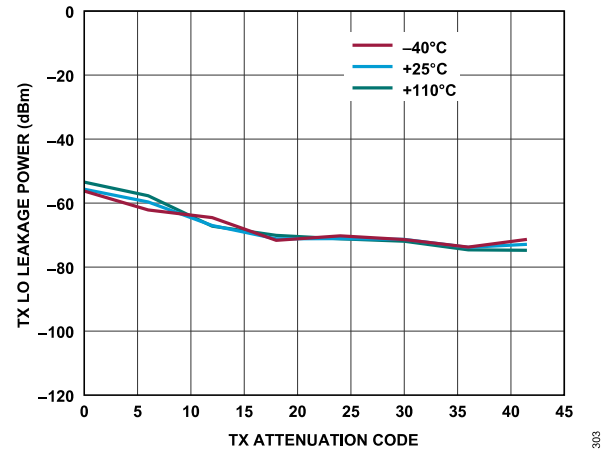

Figure 208. Transmitter LO Leakage Power vs. Transmitter Attenuation Code, Baseband Frequency = 18 MHz, Backoff = 6 dBFS, Initialization Calibration Only

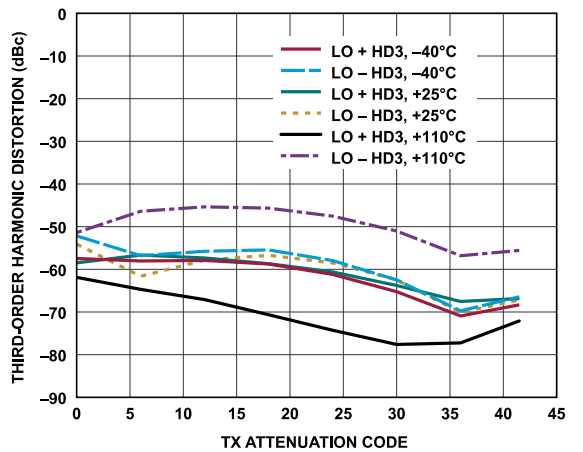

Figure 206. Transmitter Third-Order Harmonic Distortion vs. Transmitter Attenuation Code, Baseband Frequency = 18 MHz, Backoff = 0.2 dBFS

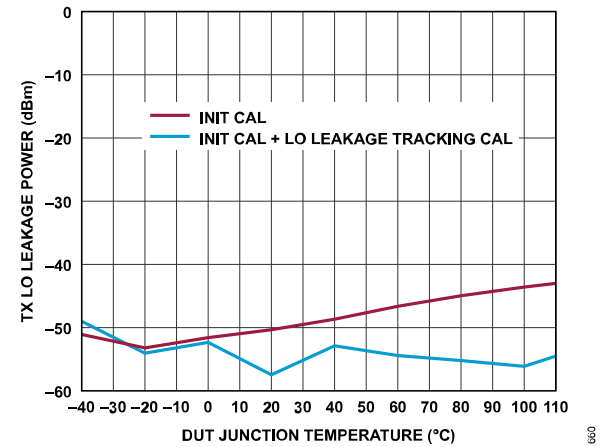

Figure 209. Transmitter LO Leakage Power vs. DUT Junction Temperature (Low to High), Baseband Frequency = 4 MHz, Backoff = 0.5 dBFS, Attenuation Code = 0

TYPICAL PERFORMANCE CHARACTERISTICS

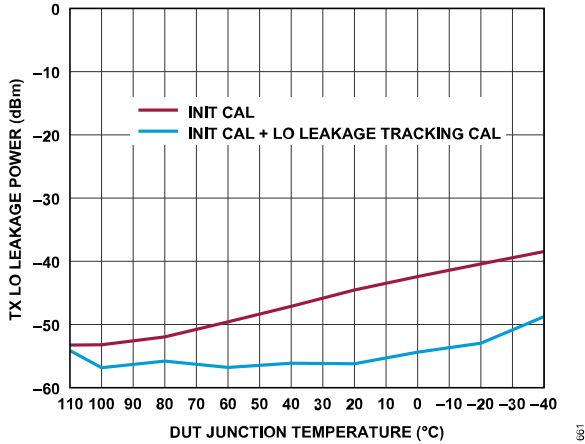

Figure 210. Transmitter LO Leakage Power vs. DUT Junction Temperature (High to Low), Baseband Frequency = 4 MHz, Backoff = 0.5 dBFS, Attenuation Code = 0

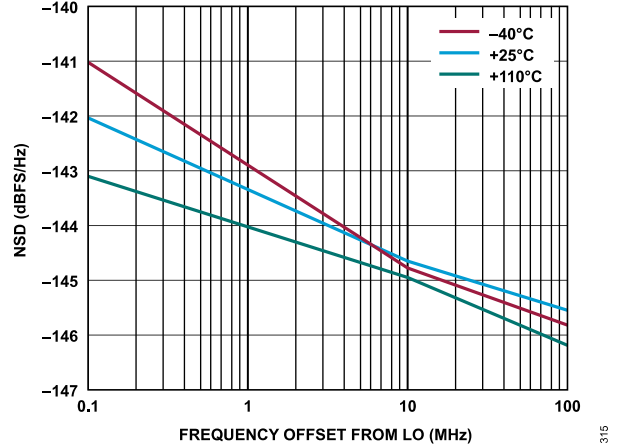

Figure 213. Transmitter NSD vs. Frequency Offset from LO, Baseband Frequency = 5.6 MHz, Transmitter Channel = Ch1

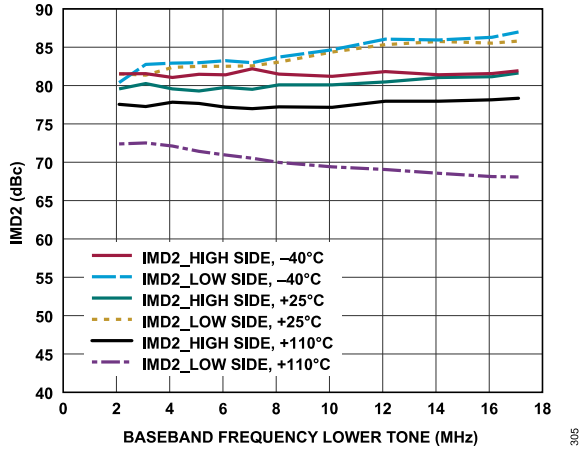

Figure 211. Transmitter IMD2 vs. Baseband Frequency, Transmitter Attenuation Code = 0, f_1 = Baseband Frequency, f_2 = Baseband Frequency + 1 MHz

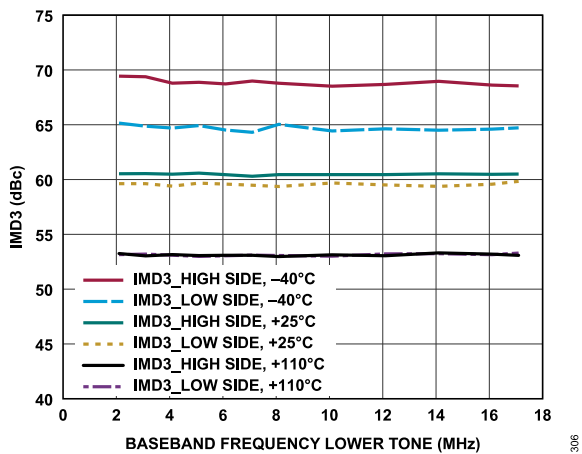

Figure 212. Transmitter IMD3 vs. Baseband Frequency, Transmitter Attenuation Code = 0, f_1 = Baseband Frequency, f_2 = Baseband Frequency + 1 MHz

TYPICAL PERFORMANCE CHARACTERISTICS

NARROW-BAND

Device configuration profile: receiver = 25 kHz bandwidth, receiver IF = 490 kHz, I/Q rate = 144 kHz, transmitter = 25 kHz bandwidth, I/Q rate = 144 kHz, device clock = 38.4 MHz, and an internal LO is used for all measurements. Measurements are at nominal power supply voltages. All RF specifications are based on measurements that include PCB and matching circuit losses, unless otherwise noted. Specifications are applicable over the lifetime of the device.

30 MHz LO

The temperature settings refer to the die temperature. All LO frequencies are set to 30 MHz, unless otherwise noted.

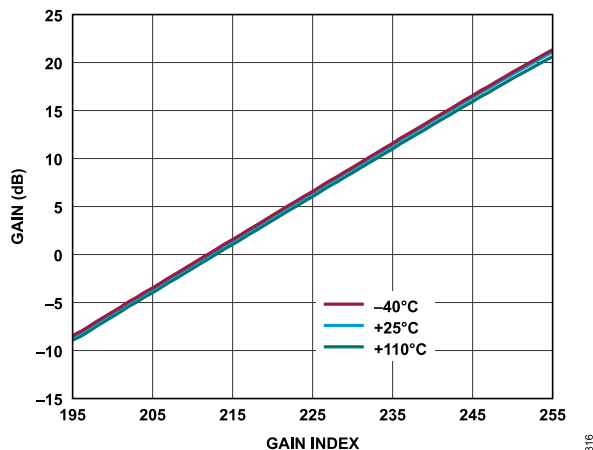

Figure 214. Receiver Absolute Gain (Complex) vs. Gain Index, Baseband Frequency = 2.1 kHz, ADC = High Performance, $P_{OUT} = -9.6$ dBFS

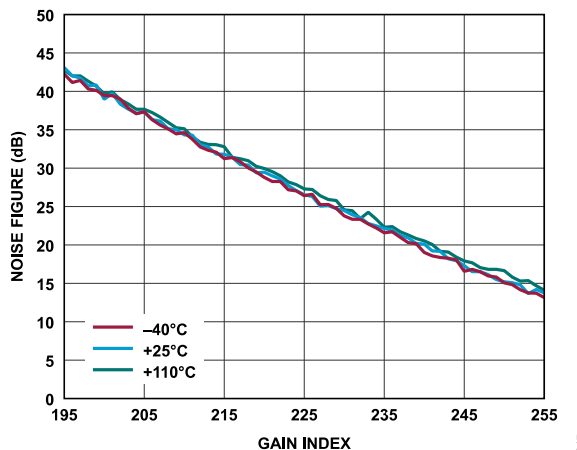

Figure 216. Receiver Noise Figure vs. Gain Index, Baseband Frequency = 2.1 kHz, ADC = High Performance

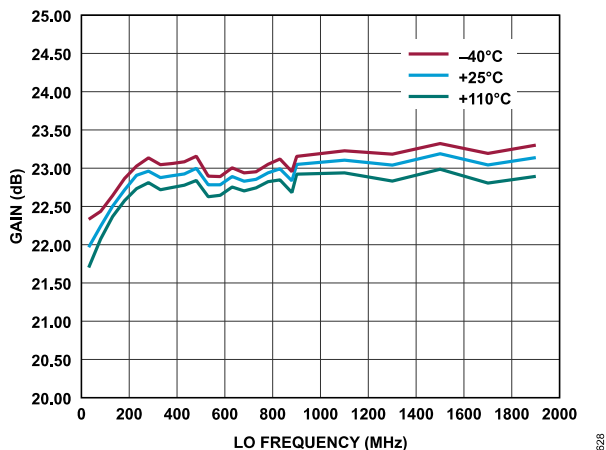

Figure 215. Receiver Absolute Gain (Complex) vs. LO Frequency, Baseband Frequency = 2.1 kHz, ADC = High Performance, $P_{OUT} = -9.6$ dBFS

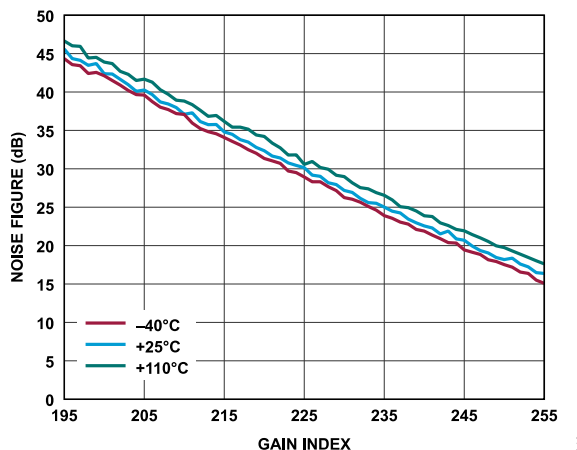

Figure 217. Receiver Noise Figure vs. Gain Index, Baseband Frequency = 2.1 kHz, ADC = Low Power

TYPICAL PERFORMANCE CHARACTERISTICS

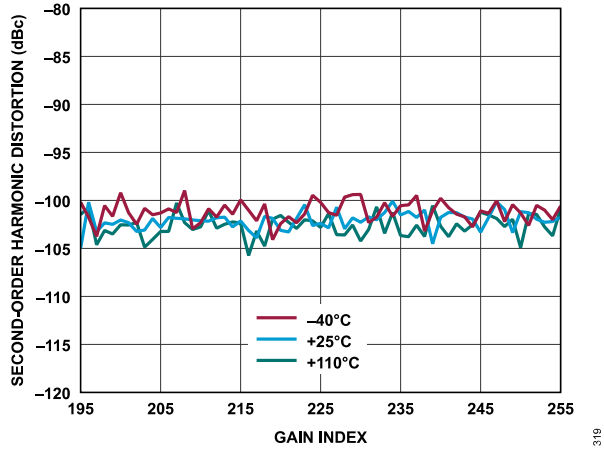

Figure 218. Receiver Second-Order Harmonic Distortion vs. Gain Index, Baseband Frequency = 2.1 kHz, ADC = High Performance

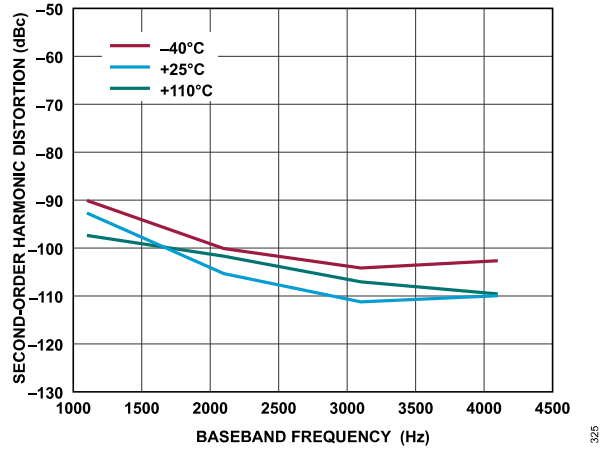

Figure 221. Receiver Second-Order Harmonic Distortion vs. Baseband Frequency, Gain Index = 255, ADC = Low Power

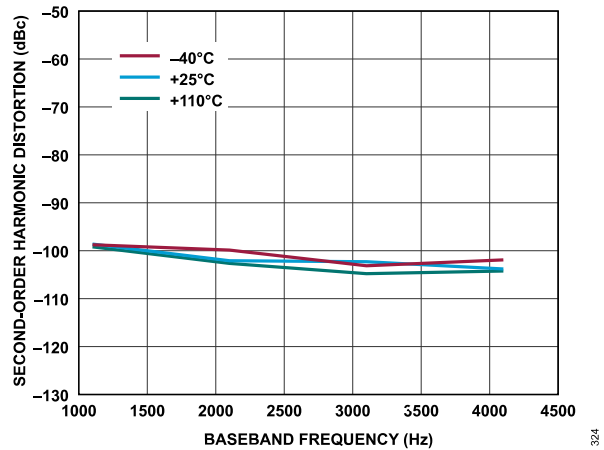

Figure 219. Receiver Second-Order Harmonic Distortion vs. Baseband Frequency, Gain Index = 255, ADC = High Performance

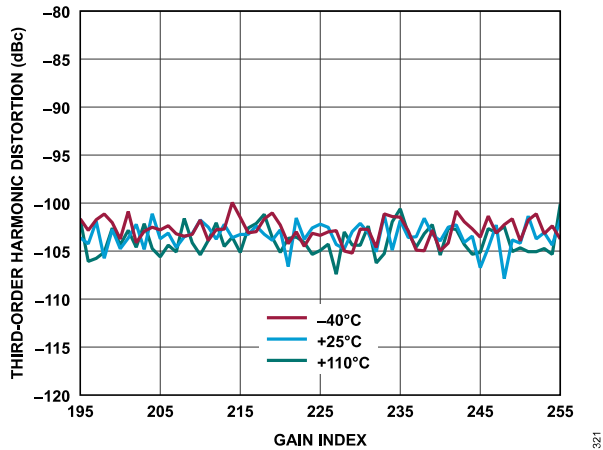

Figure 222. Receiver Third-Order Harmonic Distortion vs. Gain Index, Baseband Frequency = 2.1 kHz, ADC = High Performance

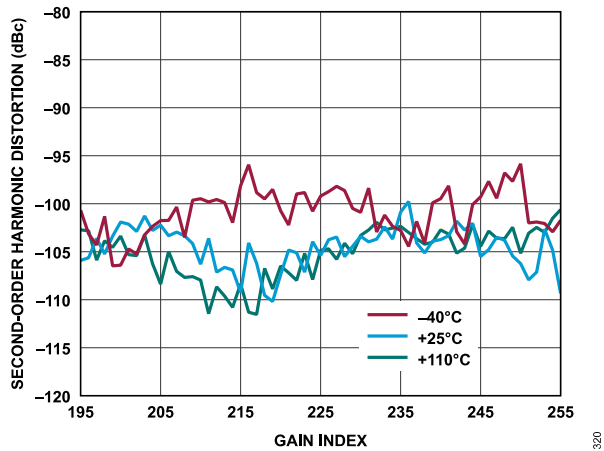

Figure 220. Receiver Second-Order Harmonic Distortion vs. Gain Index, Baseband Frequency = 2.1 kHz, ADC = Low Power

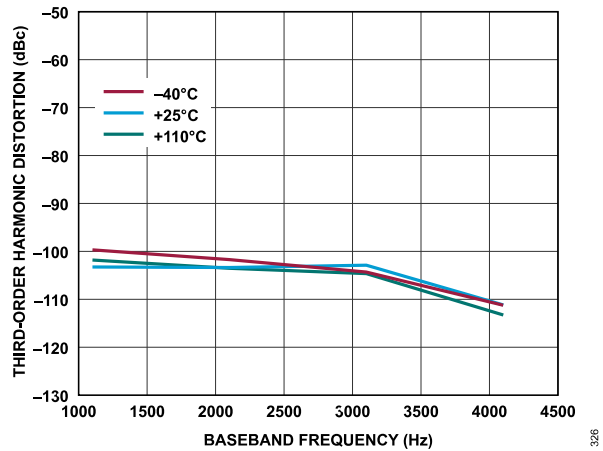

Figure 223. Receiver Third-Order Harmonic Distortion vs. Baseband Frequency, Gain Index = 255, ADC = High Performance

TYPICAL PERFORMANCE CHARACTERISTICS

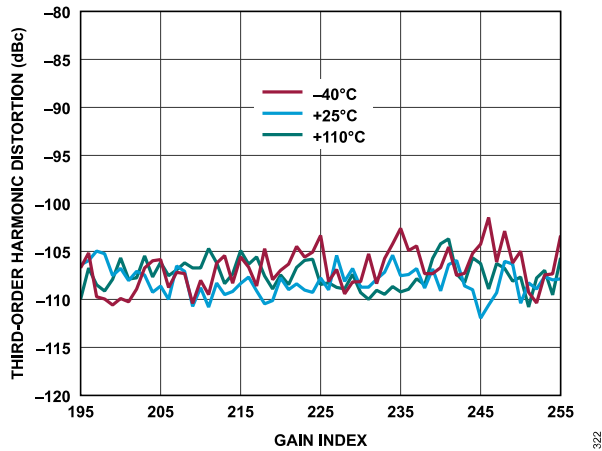

Figure 224. Receiver Third-Order Harmonic Distortion vs. Gain Index, Baseband Frequency = 2.1 kHz, ADC = Low Power

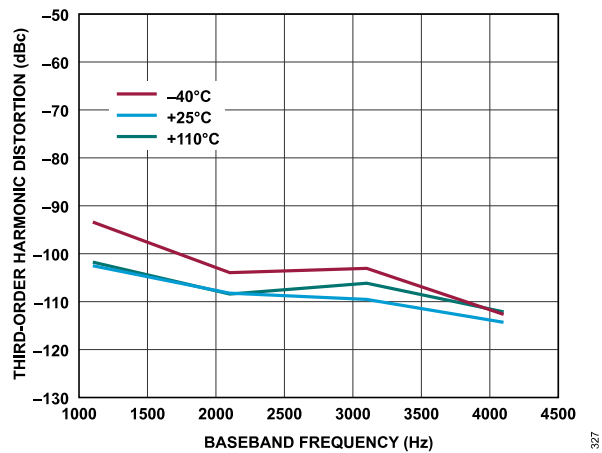

Figure 225. Receiver Third-Order Harmonic Distortion vs. Baseband Frequency, Gain Index = 255, ADC = Low Power

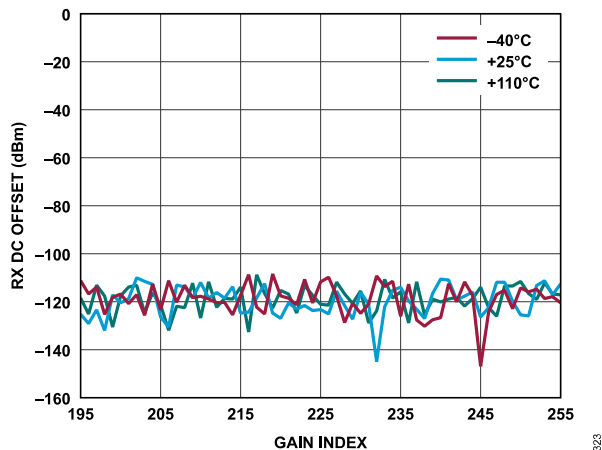

Figure 226. Receiver DC Offset vs. Gain Index, Baseband Frequency = 2.1 kHz, ADC = High Performance

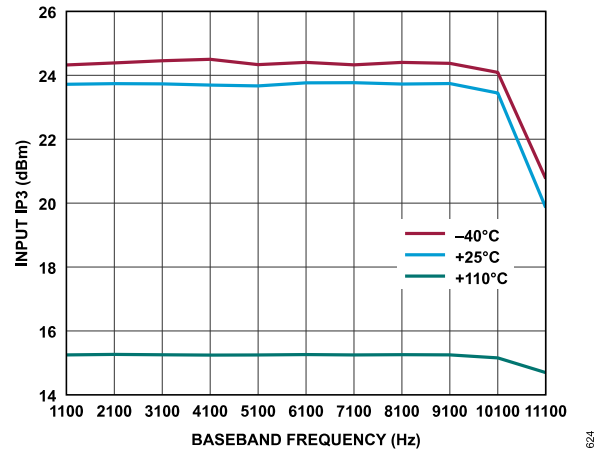

Figure 227. Receiver Input IP3 vs. Baseband Frequency, ADC = High Performance, $f_1 = \text{Baseband Frequency} + 1 \text{ MHz}$, $f_2 = \text{Baseband Frequency} + 2 \text{ MHz}$, Gain Index = 255, First-Order TIA with $f_{1dB} = 4 \text{ MHz}$, $P_{OUT} = -15.1 \text{ dBFS}$ at -40°C and $+25^\circ\text{C}$, $P_{OUT} = -18.1 \text{ dBFS}$ at $+110^\circ\text{C}$

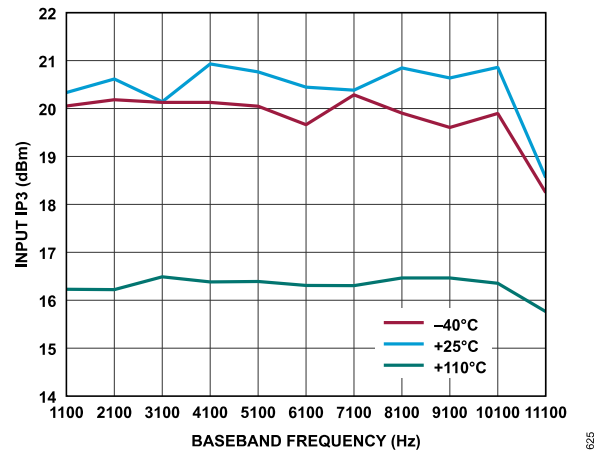

Figure 228. Receiver Input IP3 vs. Baseband Frequency, ADC = Low Power, $f_1 = \text{Baseband Frequency} + 1 \text{ MHz}$, $f_2 = \text{Baseband Frequency} + 2 \text{ MHz}$, Gain Index = 255, First-Order TIA with $f_{1dB} = 4 \text{ MHz}$, $P_{OUT} = -15.1 \text{ dBFS}$ at -40°C and $+25^\circ\text{C}$, $P_{OUT} = -18.1 \text{ dBFS}$ at $+110^\circ\text{C}$

TYPICAL PERFORMANCE CHARACTERISTICS

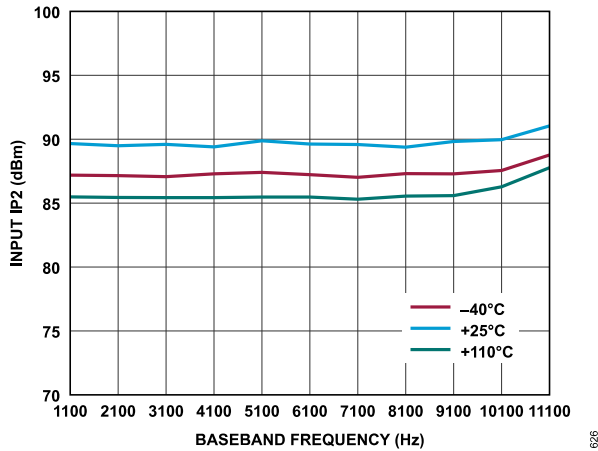

Figure 229. Receiver Input IP2 vs. Baseband Frequency, ADC = High Performance, f_1 = Baseband Frequency + 1 MHz, f_2 = Baseband Frequency + 2 MHz, Gain Index = 255, First-Order TIA with f_{3dB} = 4 MHz, P_{OUT} = -11.6 dBFS

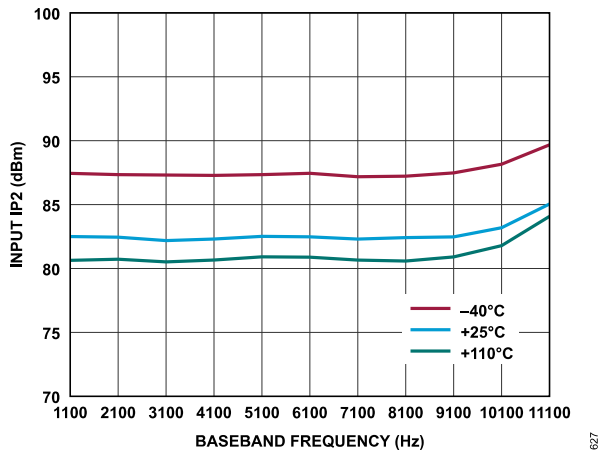

Figure 230. Receiver Input IP2 vs. Baseband Frequency, ADC = Low Power, f_1 = Baseband Frequency + 1 MHz, f_2 = Baseband Frequency + 2 MHz, Gain Index = 255, First-Order TIA with f_{3dB} = 4 MHz, P_{OUT} = -11.6 dBFS

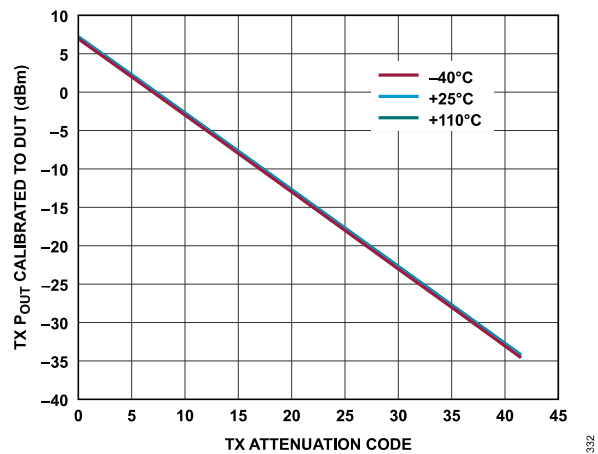

Figure 231. Transmitter Absolute Power vs. Transmitter Attenuation Code, Baseband Frequency = 2.1 kHz, Backoff = 0.2 dBFS

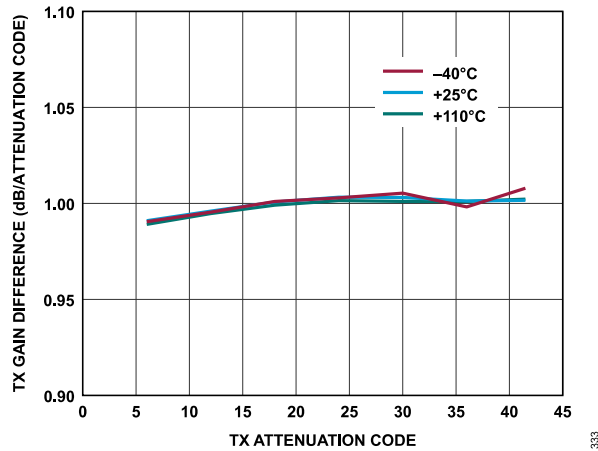

Figure 232. Transmitter Attenuation Delta (Error) vs. Transmitter Attenuation Code, Baseband Frequency = 2.1 kHz, Backoff = 0.2 dBFS

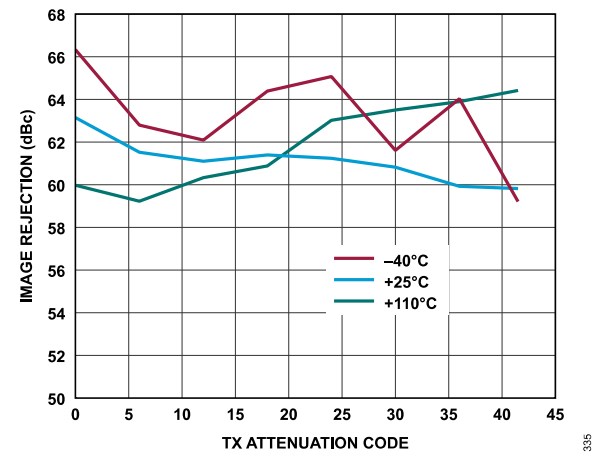

Figure 233. Transmitter Image Rejection vs. Transmitter Attenuation Code, Baseband Frequency = 2.1 kHz, Backoff = 0.2 dBFS

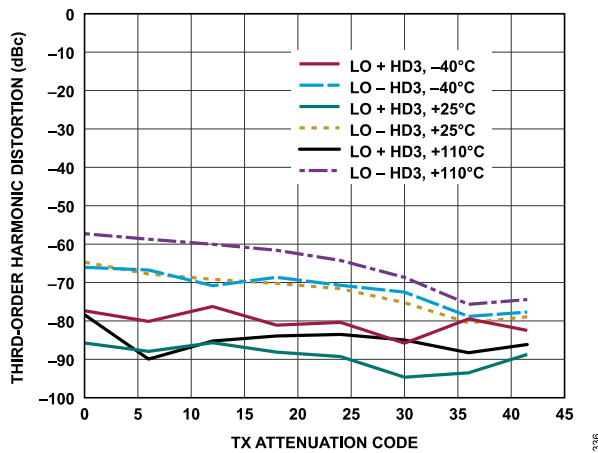

Figure 234. Transmitter Third-Order Harmonic Distortion vs. Transmitter Attenuation Code, Baseband Frequency = 2.1 kHz, Backoff = 0.2 dBFS, Initialization Calibration Only

TYPICAL PERFORMANCE CHARACTERISTICS

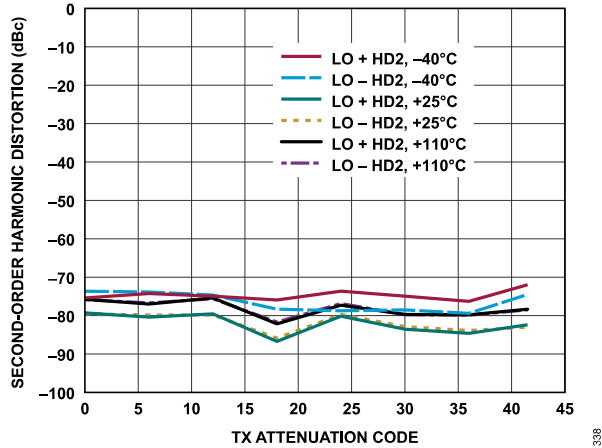

Figure 235. Transmitter Second-Order Harmonic Distortion vs. Transmitter Attenuation Code, Baseband Frequency = 2.1 kHz, Backoff = 0.2 dBFS

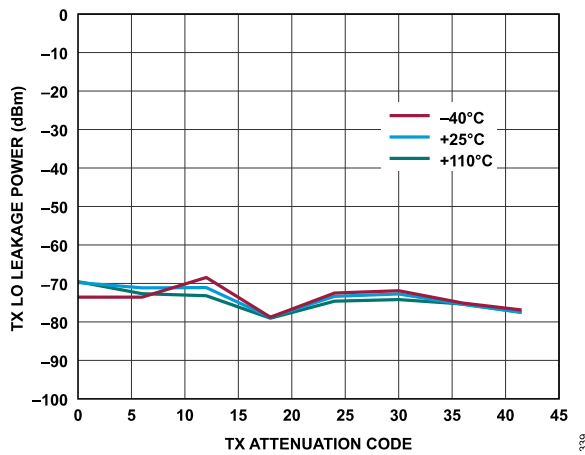

Figure 236. Transmitter LO Leakage Power vs. Transmitter Attenuation Code, Baseband Frequency = 2.1 kHz, Backoff = 6 dBFS, Initialization Calibration Only

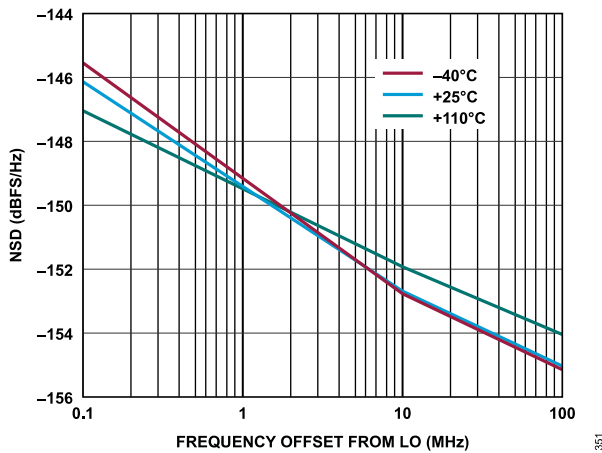

Figure 237. Transmitter NSD vs. Frequency Offset from LO, Baseband Frequency = 2.1 kHz, Transmitter Channel = Channel 1

TYPICAL PERFORMANCE CHARACTERISTICS

470 MHz LO

The temperature settings refer to the die temperature. All LO frequencies set to 470 MHz, unless otherwise noted.

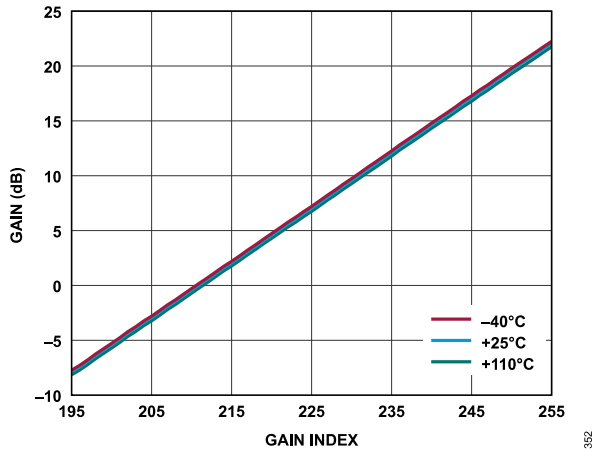

Figure 238. Receiver Absolute Gain (Complex) vs. Gain Index, Baseband Frequency = 2.1 kHz, ADC = High Performance, $P_{OUT} = -9.6$ dBFS

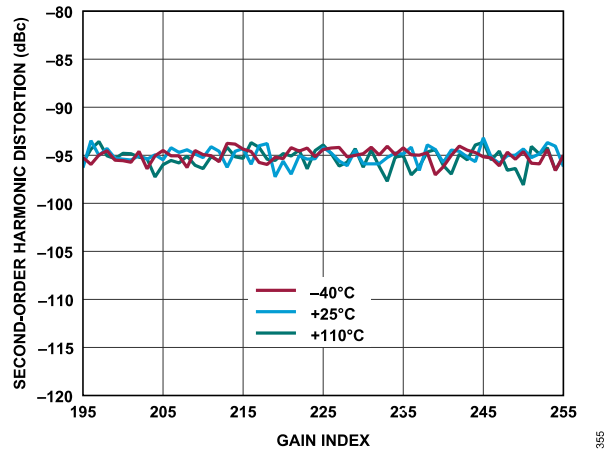

Figure 241. Receiver Second-Order Harmonic Distortion vs. Gain Index, Baseband Frequency = 2.1 kHz, ADC = High Performance

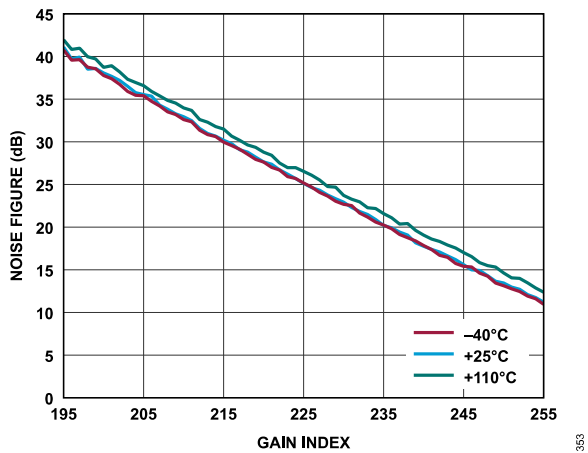

Figure 239. Receiver Noise Figure vs. Gain Index, Baseband Frequency = 2.1 kHz, ADC = High Performance

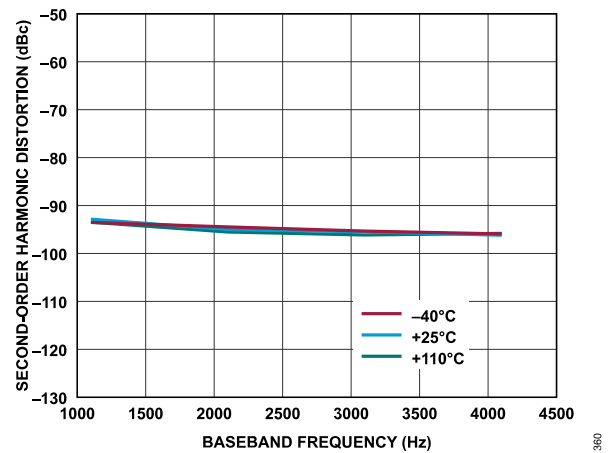

Figure 242. Receiver Second-Order Harmonic Distortion vs. Baseband Frequency, Gain Index = 255, ADC = High Performance

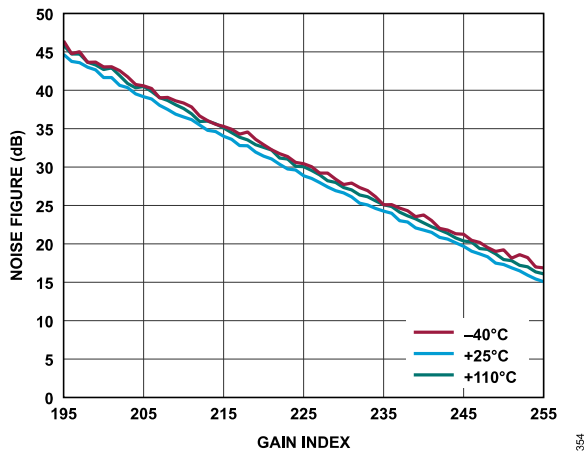

Figure 240. Receiver Noise Figure vs. Gain Index, Baseband Frequency = 2.1 kHz, ADC = Low Power

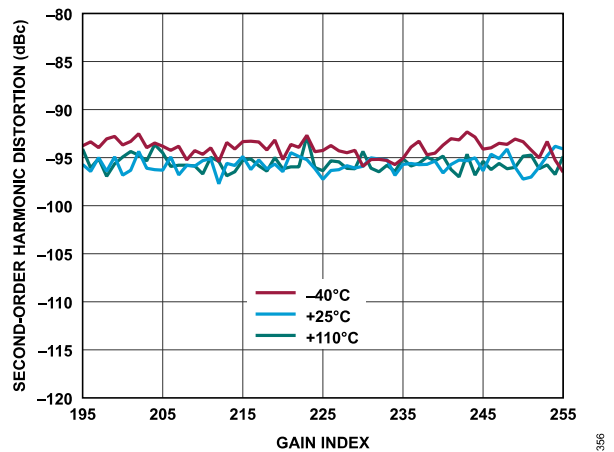

Figure 243. Receiver Second-Order Harmonic Distortion vs. Gain Index, Baseband Frequency = 2.1 kHz, ADC = Low Power

TYPICAL PERFORMANCE CHARACTERISTICS

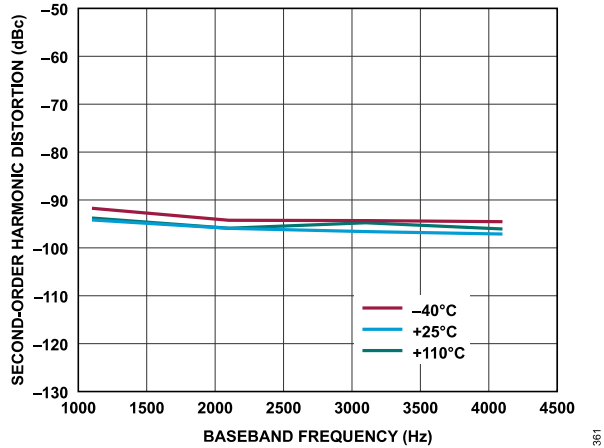

Figure 244. Receiver Second-Order Harmonic Distortion vs. Baseband Frequency, Gain Index = 255, ADC = Low Power

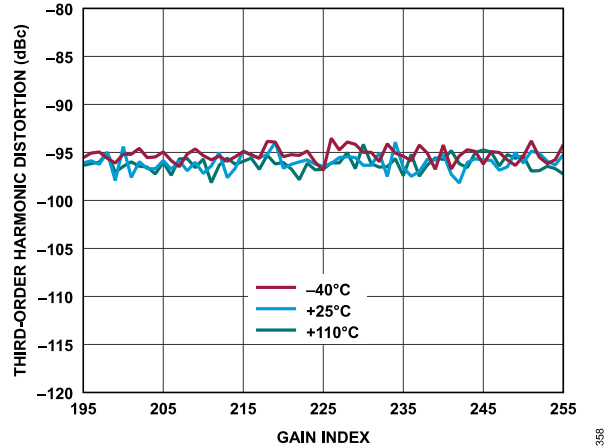

Figure 247. Receiver Third-Order Harmonic Distortion vs. Gain Index, Baseband Frequency = 2.1 kHz, ADC = Low Power

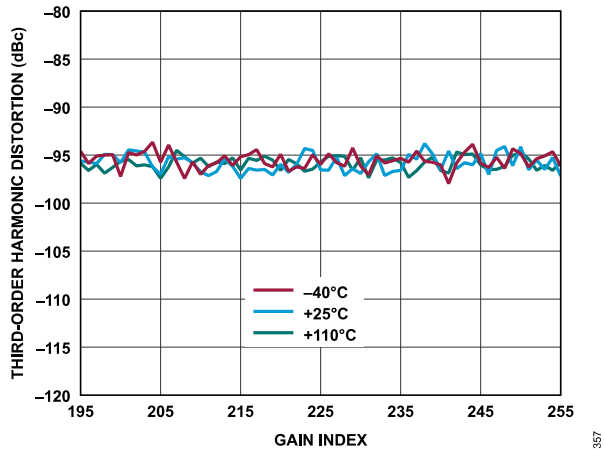

Figure 245. Receiver Third-Order Harmonic Distortion vs. Gain Index, Baseband Frequency = 2.1 kHz, ADC = High Performance

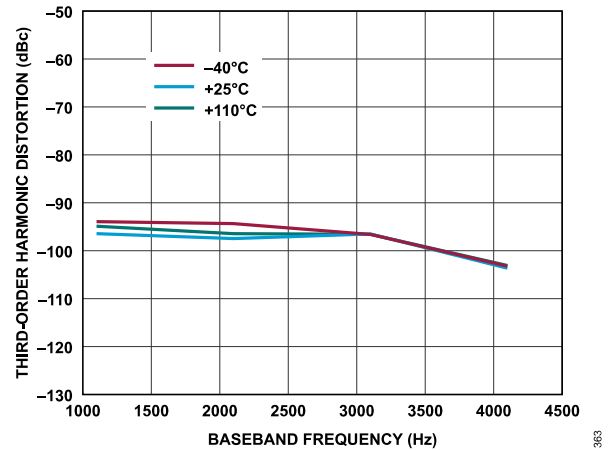

Figure 248. Receiver Third-Order Harmonic Distortion vs. Baseband Frequency, Gain Index = 255, ADC = Low Power

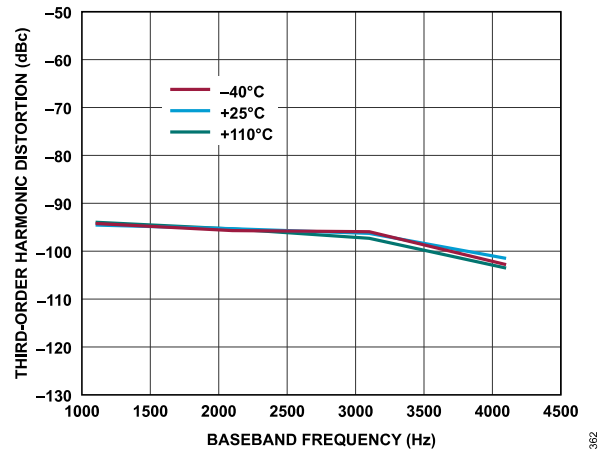

Figure 246. Receiver Third-Order Harmonic Distortion vs. Baseband Frequency, Gain Index = 255, ADC = High Performance

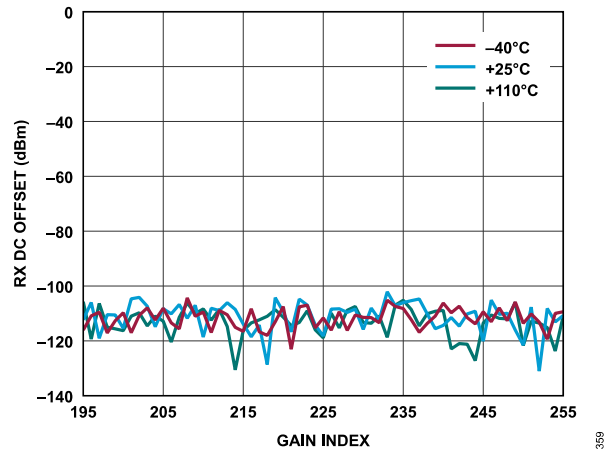

Figure 249. Receiver DC Offset vs. Gain Index, Baseband Frequency = 2.1 kHz, ADC = High Performance

TYPICAL PERFORMANCE CHARACTERISTICS

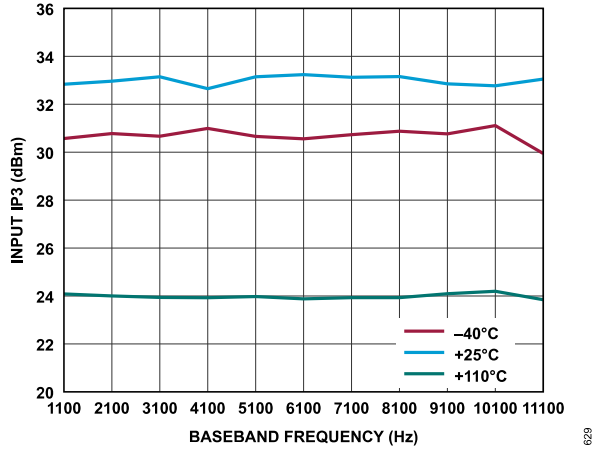

Figure 250. Receiver Input IP3 vs. Baseband Frequency, ADC = High Performance, f_1 = Baseband Frequency + 1 MHz, f_2 = Baseband Frequency + 2 MHz, Gain Index = 255, First-Order TIA with f_{1dB} = 4 MHz, P_{OUT} = -13.6 dBFS at -40°C and +25°C, P_{OUT} = -16.6 dBFS at +110°C

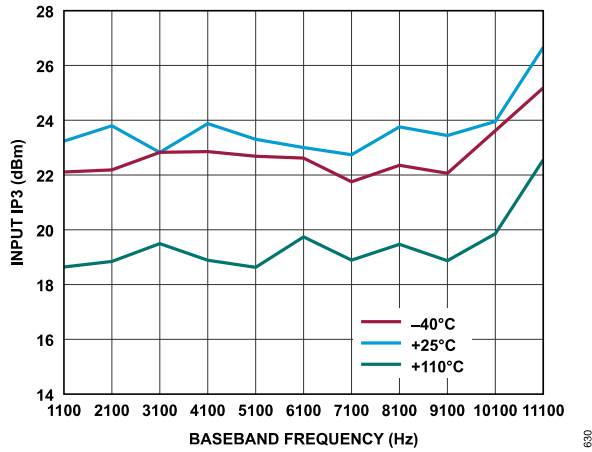

Figure 251. Receiver Input IP3 vs. Baseband Frequency, ADC = Low Power, f_1 = Baseband Frequency + 1 MHz, f_2 = Baseband Frequency + 2 MHz, Gain Index = 255, First-Order TIA with f_{1dB} = 4 MHz, P_{OUT} = -13.6 dBFS at -40°C and +25°C, P_{OUT} = -16.6 dBFS at +110°C

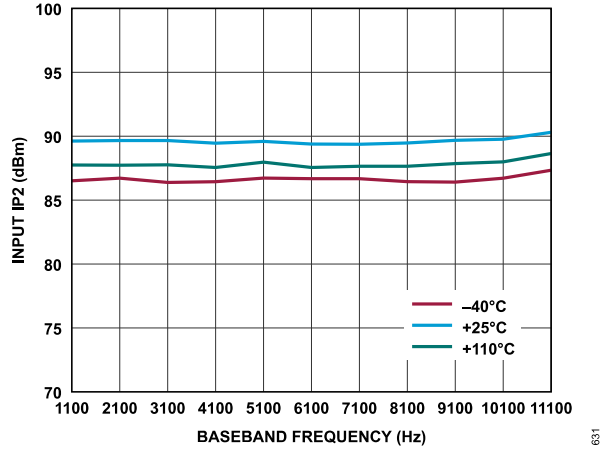

Figure 252. Receiver Input IP2 vs. Baseband Frequency, ADC = High Performance, f_1 = Baseband Frequency + 1 MHz, f_2 = Baseband Frequency + 2 MHz, Gain Index = 255, First-Order TIA with f_{3dB} = 4 MHz, P_{OUT} = -11.6 dBFS

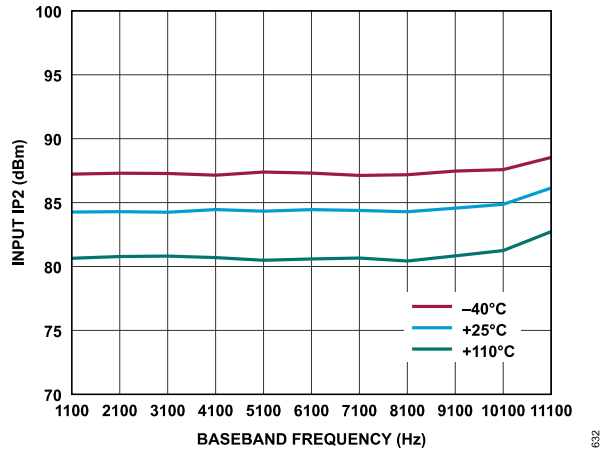

Figure 253. Receiver Input IP2 vs. Baseband Frequency, ADC = Low Power, f_1 = Baseband Frequency + 1 MHz, f_2 = Baseband Frequency + 2 MHz, Gain Index = 255, First-Order TIA with f_{3dB} = 4 MHz, P_{OUT} = -11.6 dBFS

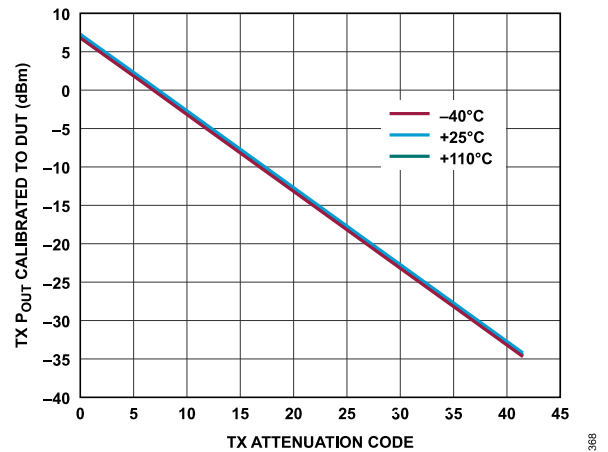

Figure 254. Transmitter Absolute Power vs. Transmitter Attenuation Code, Baseband Frequency = 2.1 kHz, Backoff = 0.2 dBFS

TYPICAL PERFORMANCE CHARACTERISTICS

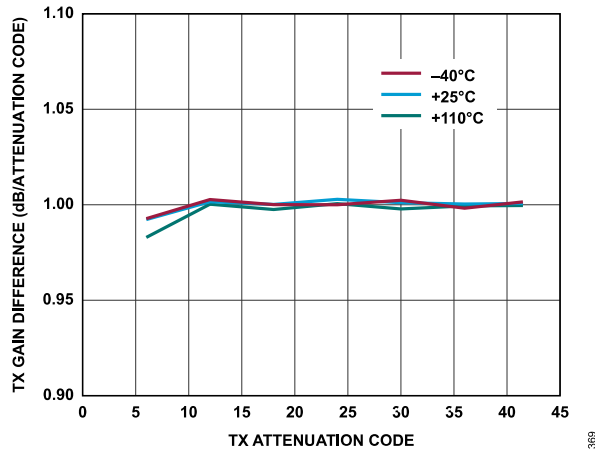

Figure 255. Transmitter Attenuation Delta (Error) vs. Transmitter Attenuation Code, Baseband Frequency = 2.1 kHz, Backoff = 0.2 dBFS

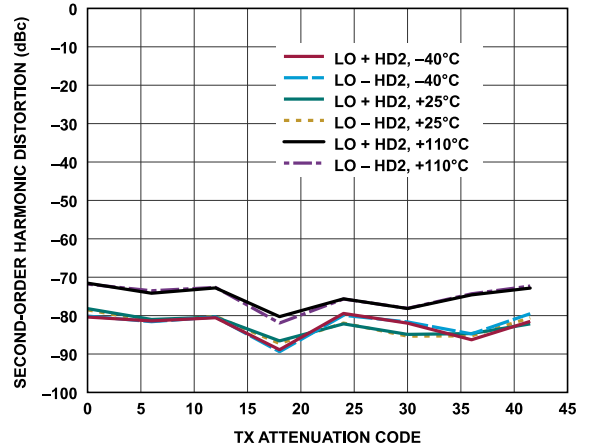

Figure 258. Transmitter Second-Order Harmonic Distortion vs. Transmitter Attenuation Code, Baseband Frequency = 2.1 kHz, Backoff = 0.2 dBFS

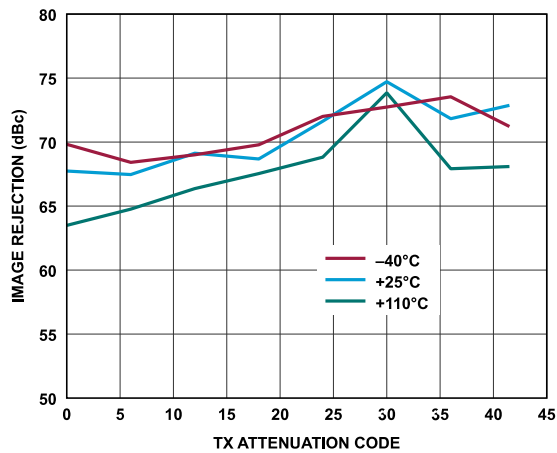

Figure 256. Transmitter Image Rejection vs. Transmitter Attenuation Code, Baseband Frequency = 2.1 kHz, Backoff = 0.2 dBFS, Initialization Calibration Only

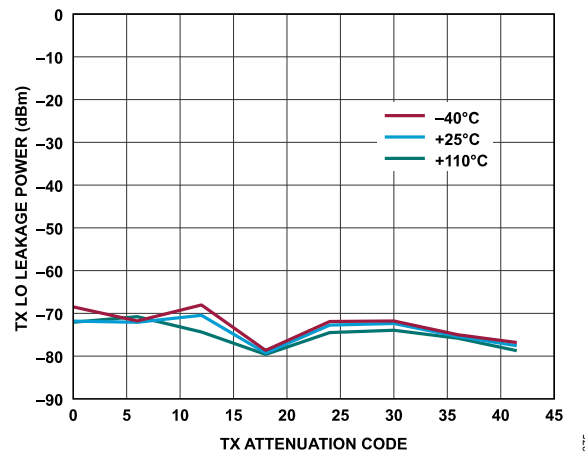

Figure 259. Transmitter LO Leakage Power vs. Transmitter Attenuation Code, Baseband Frequency = 2.1 kHz, Backoff = 6 dBFS, Initialization Calibration Only

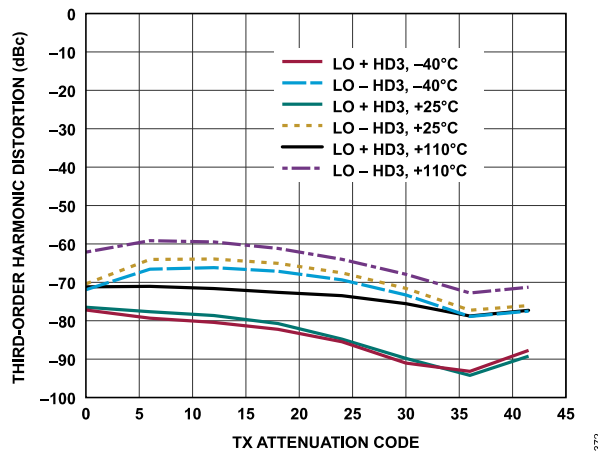

Figure 257. Transmitter Third-Order Harmonic Distortion vs. Transmitter Attenuation Code, Baseband Frequency = 2.1 kHz, Backoff = 0.2 dBFS

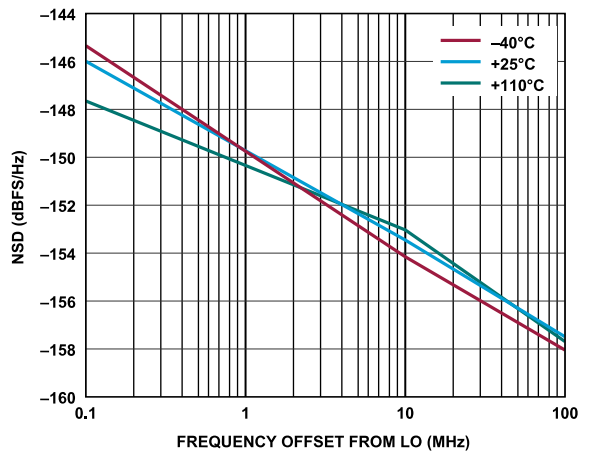

Figure 260. Transmitter NSD vs. Frequency Offset from LO, Baseband Frequency = 2.1 kHz, Transmitter Channel = Channel 1

TYPICAL PERFORMANCE CHARACTERISTICS

900 MHz LO

The temperature settings refer to the die temperature. All LO frequencies set to 900 MHz, unless otherwise noted.

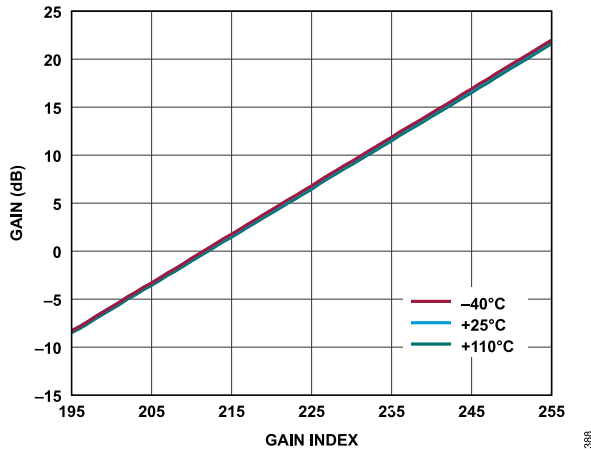

Figure 261. Receiver Absolute Gain (Complex) vs. Gain Index, Baseband Frequency = 2.1 kHz, ADC = High Performance, $P_{OUT} = -9.6$ dBFS

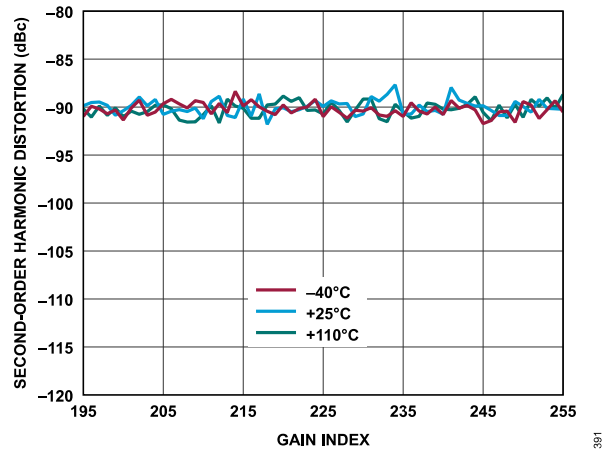

Figure 264. Receiver Second-Order Harmonic Distortion vs. Gain Index, Baseband Frequency = 2.1 kHz, ADC = High Performance

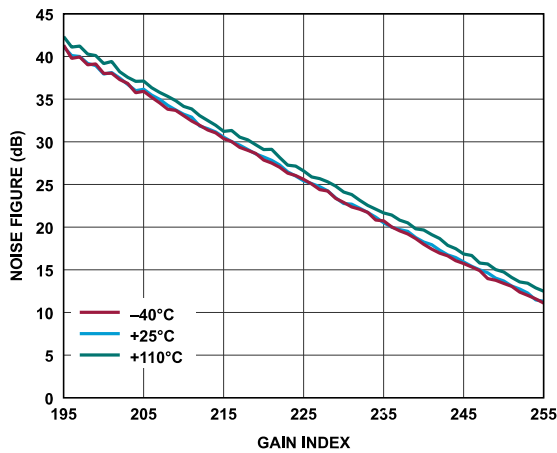

Figure 262. Receiver Noise Figure vs. Gain Index, Baseband Frequency = 2.1 kHz, ADC = High Performance

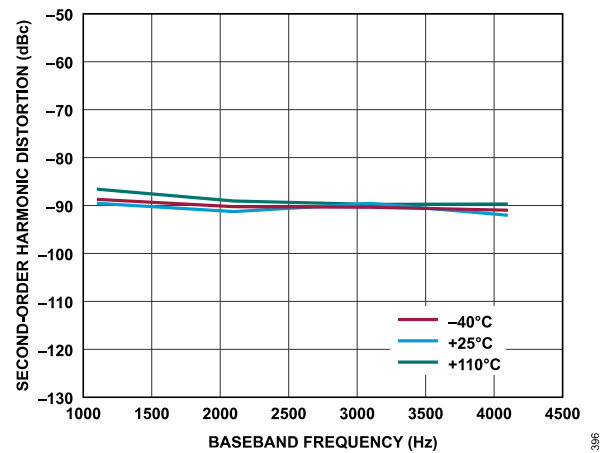

Figure 265. Receiver Second-Order Harmonic Distortion vs. Baseband Frequency, Gain Index = 255, ADC = High Performance

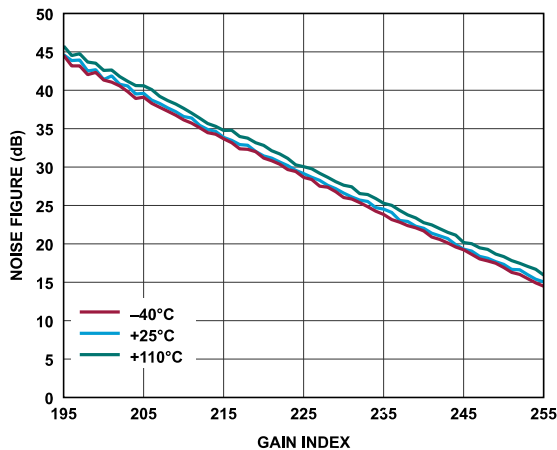

Figure 263. Receiver Noise Figure vs. Gain Index, Baseband Frequency = 2.1 kHz, ADC = Low Power

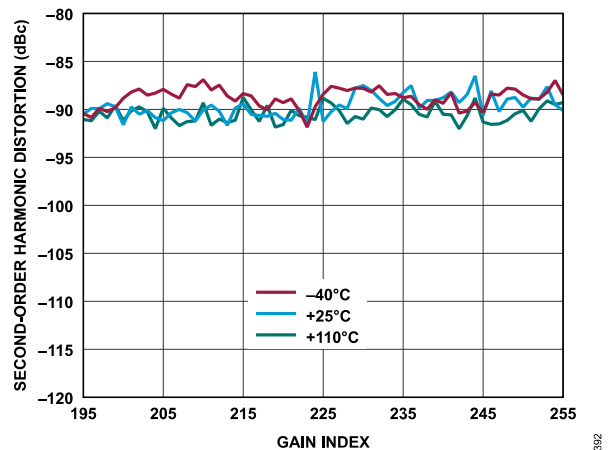

Figure 266. Receiver Second-Order Harmonic Distortion vs. Gain Index, Baseband Frequency = 2.1 kHz, ADC = Low Power

TYPICAL PERFORMANCE CHARACTERISTICS

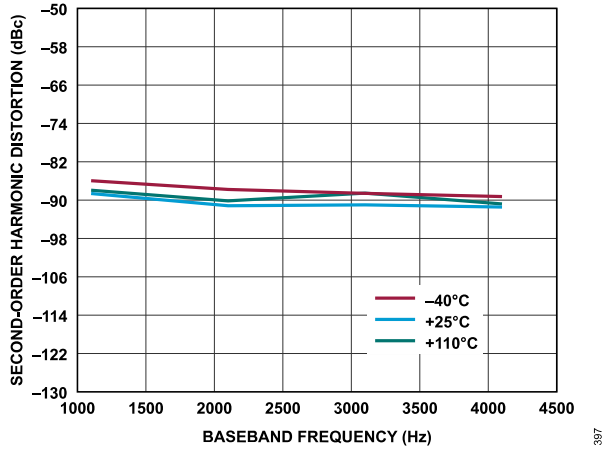

Figure 267. Receiver Second-Order Harmonic Distortion vs. Baseband Frequency, Gain Index = 255, ADC = Low Power

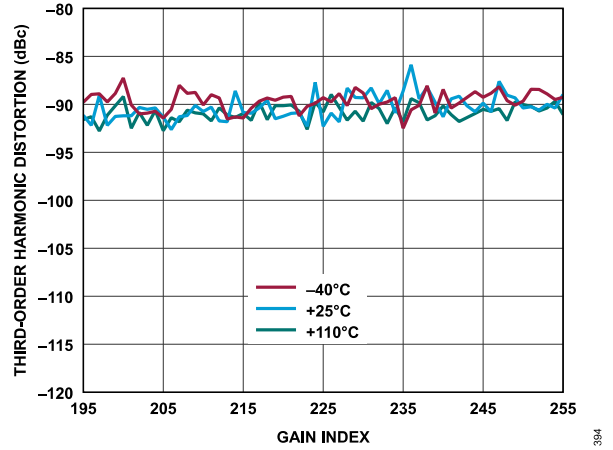

Figure 270. Receiver Third-Order Harmonic Distortion vs. Gain Index, Baseband Frequency = 2.1 kHz, ADC = Low Power

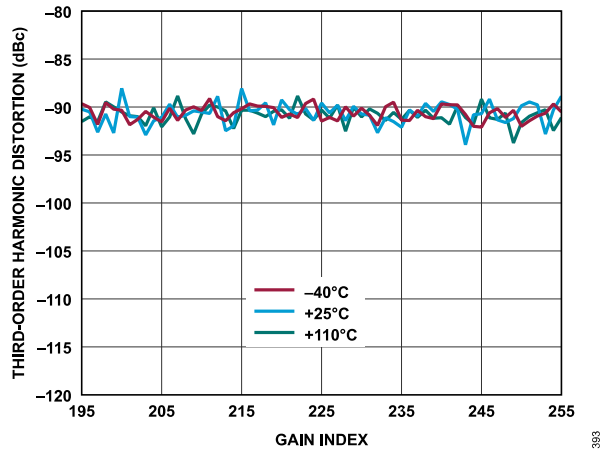

Figure 268. Receiver Third-Order Harmonic Distortion vs. Gain Index, Baseband Frequency = 2.1 kHz, ADC = High Performance

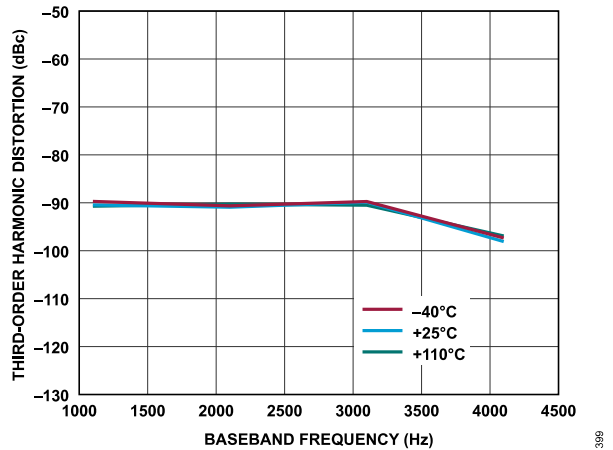

Figure 271. Receiver Third-Order Harmonic Distortion vs. Baseband Frequency, Gain Index = 255, ADC = Low Power

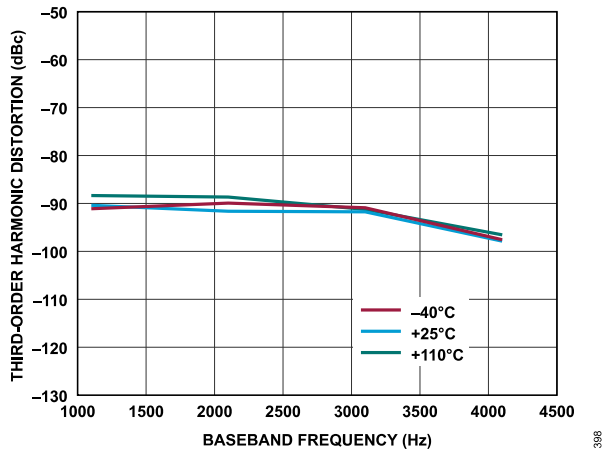

Figure 269. Receiver Third-Order Harmonic Distortion vs. Baseband Frequency, Gain Index = 255, ADC = High Performance

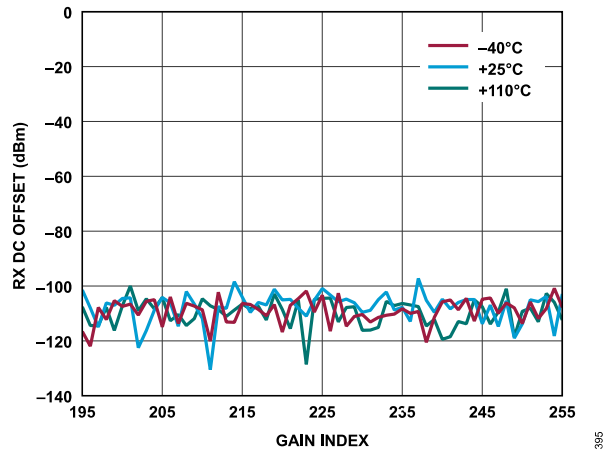

Figure 272. Receiver DC Offset vs. Gain Index, Baseband Frequency = 2.1 kHz, ADC = High Performance

TYPICAL PERFORMANCE CHARACTERISTICS

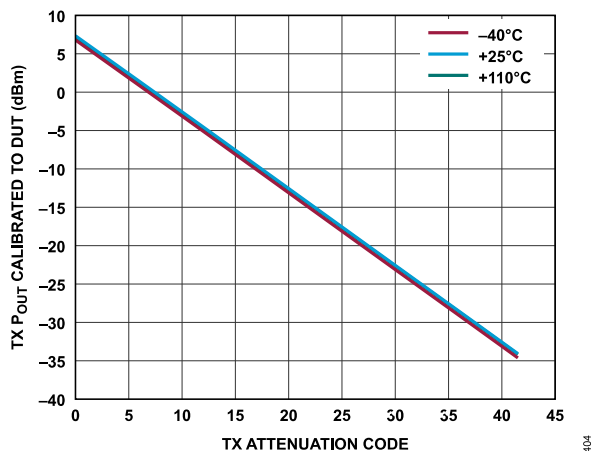

Figure 273. Transmitter Absolute Power vs. Transmitter Attenuation Code, Baseband Frequency = 2.1 kHz, Backoff = 0.2 dBFS

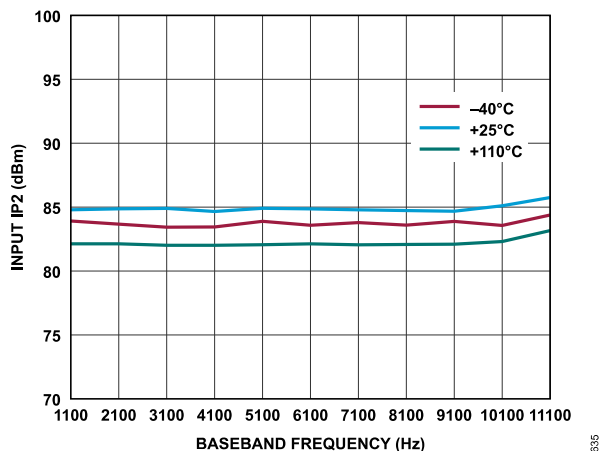

Figure 276. Receiver Input IP2 vs. Baseband Frequency, ADC = High Performance, f_1 = Baseband Frequency + 1 MHz, f_2 = Baseband Frequency + 2 MHz, Gain Index = 255, First-Order TIA with $f_{3dB} = 4$ MHz, $P_{OUT} = -11.6$ dBFS

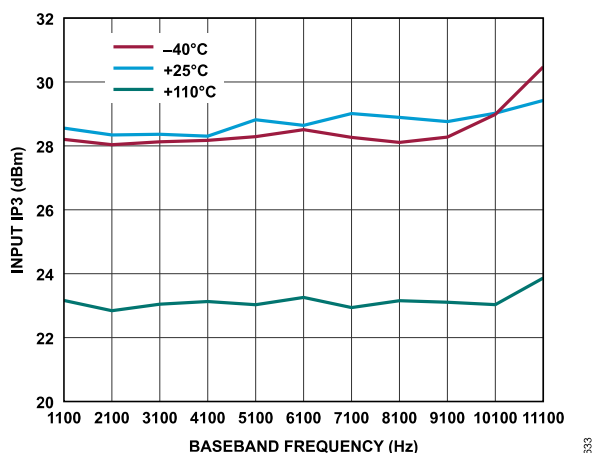

Figure 274. Receiver Input IP3 vs. Baseband Frequency, ADC = High Performance, f_1 = Baseband Frequency + 1 MHz, f_2 = Baseband Frequency + 2 MHz, Gain Index = 255, First-Order TIA with $f_{1dB} = 4$ MHz, $P_{OUT} = -15.1$ dBFS at -40°C and $+25^\circ\text{C}$, $P_{OUT} = -18.1$ dBFS at $+110^\circ\text{C}$

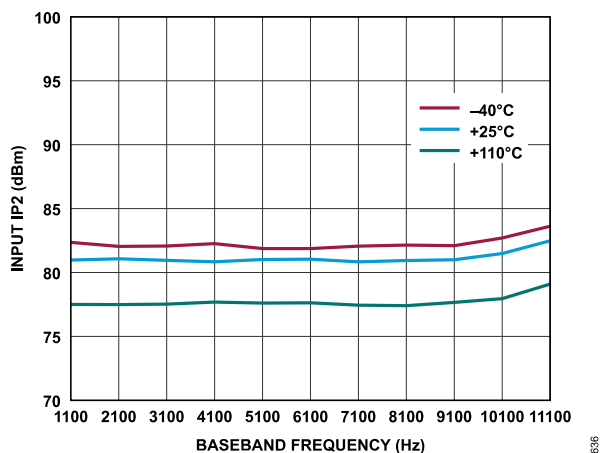

Figure 277. Receiver Input IP2 vs. Baseband Frequency, ADC = Low Power, f_1 = Baseband Frequency + 1 MHz, f_2 = Baseband Frequency + 2 MHz, Gain Index = 255, First-Order TIA with $f_{3dB} = 4$ MHz, $P_{OUT} = -11.6$ dBFS

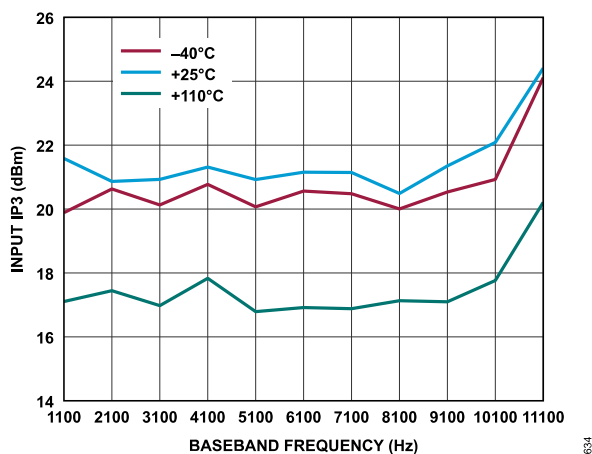

Figure 275. Receiver Input IP3 vs. Baseband Frequency, ADC = Low Power, f_1 = Baseband Frequency + 1 MHz, f_2 = Baseband Frequency + 2 MHz, Gain Index = 255, First-Order TIA with $f_{1dB} = 4$ MHz, $P_{OUT} = -15.1$ dBFS at -40°C and $+25^\circ\text{C}$, $P_{OUT} = -18.1$ dBFS at $+110^\circ\text{C}$

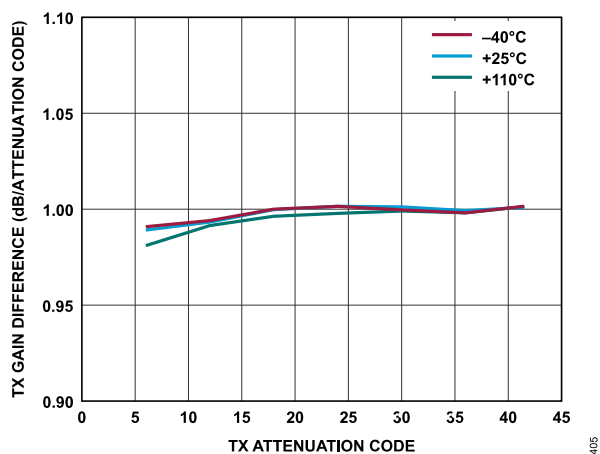

Figure 278. Transmitter Attenuation Delta (Error) vs. Transmitter Attenuation Code, Baseband Frequency = 2.1 kHz, Backoff = 0.2 dBFS

TYPICAL PERFORMANCE CHARACTERISTICS

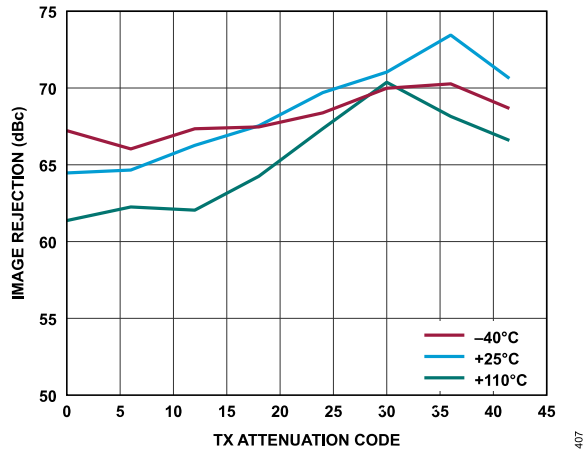

Figure 279. Transmitter Image Rejection vs. Transmitter Attenuation Code, Baseband Frequency = 2.1 kHz, Backoff = 0.2 dBFS, Initialization Calibration Only

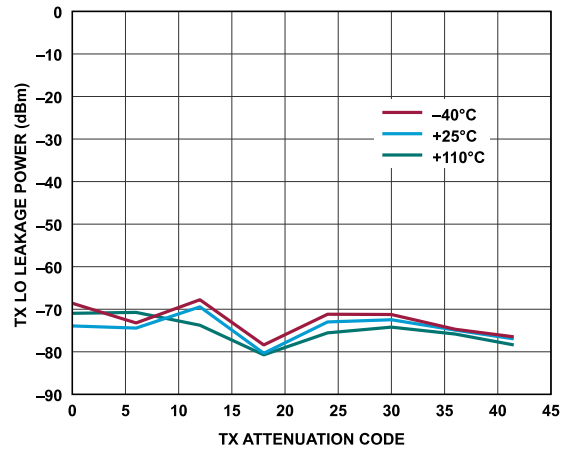

Figure 282. Transmitter LO Leakage Power vs. Transmitter Attenuation Code, Baseband Frequency = 2.1 kHz, Backoff = 6 dBFS, Initialization Calibration Only

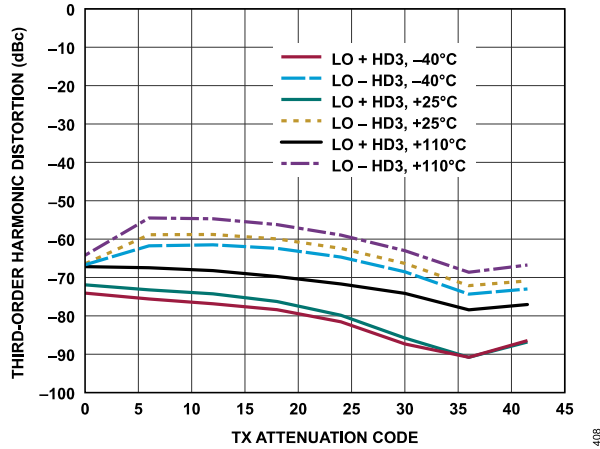

Figure 280. Transmitter Third-Order Harmonic Distortion vs. Transmitter Attenuation Code, Baseband Frequency = 2.1 kHz, Backoff = 0.2 dBFS

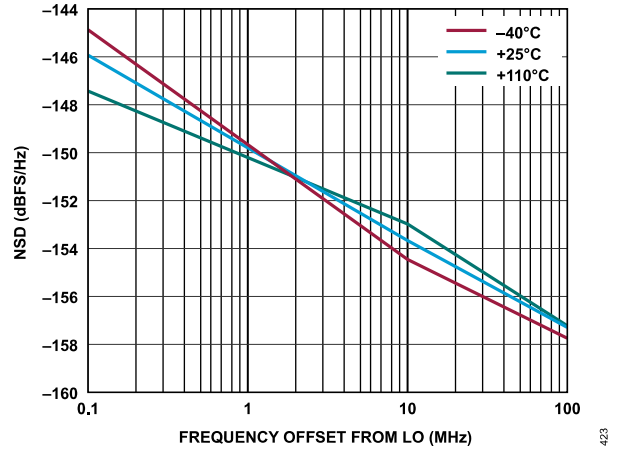

Figure 283. Transmitter NSD vs. Frequency Offset from LO, Baseband Frequency = 2.1 kHz, Transmitter Channel = Channel 1

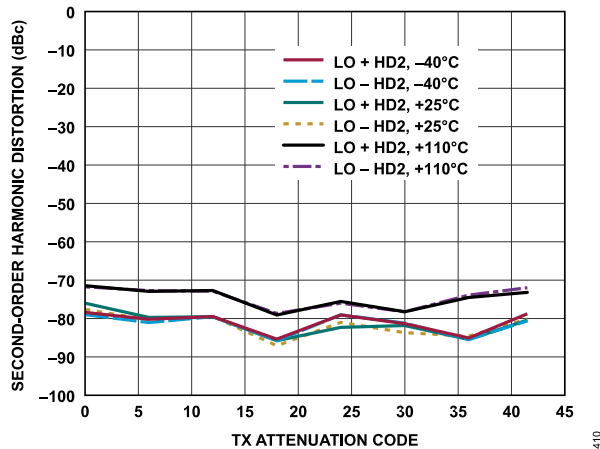

Figure 281. Transmitter HD2 vs. Transmitter Attenuation Code, Baseband Frequency = 2.1 kHz, Backoff = 0.2 dBFS

TYPICAL PERFORMANCE CHARACTERISTICS

2400 MHz LO

The temperature settings refer to the die temperature. All LO frequencies set to 2400 MHz, unless otherwise noted.

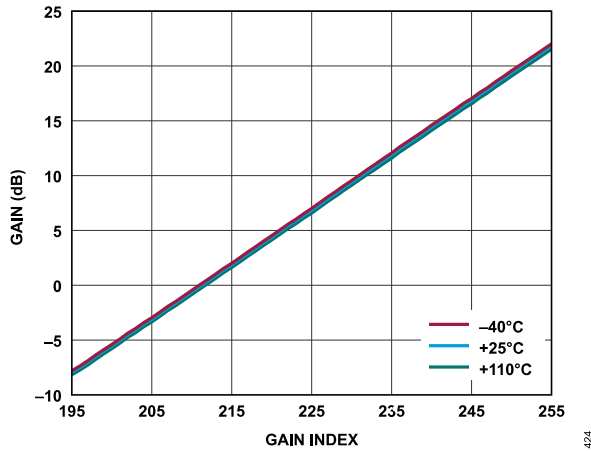

Figure 284. Receiver Absolute Gain (Complex) vs. Gain Index, Baseband Frequency = 2.1 kHz, ADC = High Performance, $P_{OUT} = -9.6$ dBFS

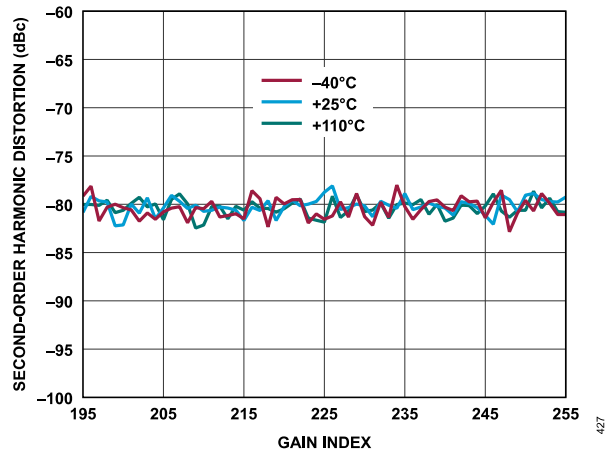

Figure 287. Receiver Second-Order Harmonic Distortion vs. Gain Index, Baseband Frequency = 2.1 kHz, ADC = High Performance

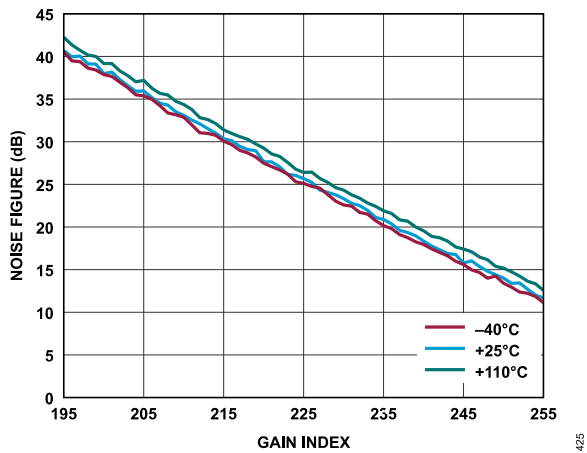

Figure 285. Receiver Noise Figure vs. Gain Index, Baseband Frequency = 2.1 kHz, ADC = High Performance

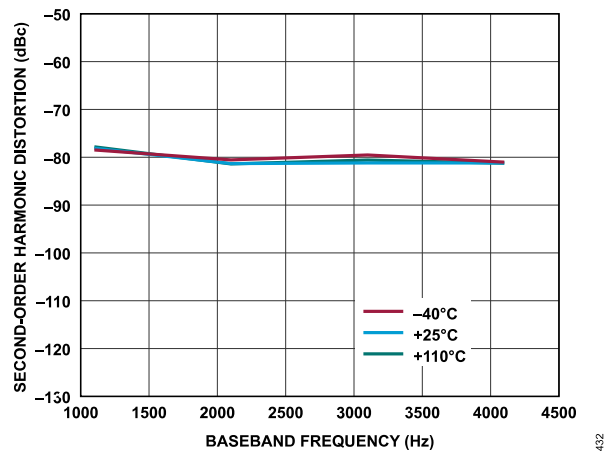

Figure 288. Receiver Second-Order Harmonic Distortion vs. Baseband Frequency, Gain Index = 255, ADC = High Performance

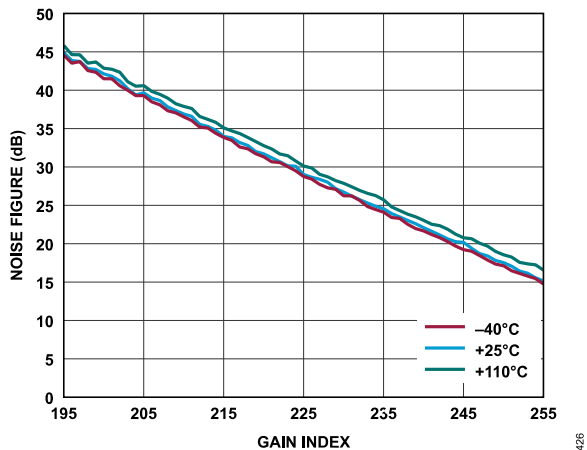

Figure 286. Receiver Noise Figure vs. Gain Index, Baseband Frequency = 2.1 kHz, ADC = Low Power

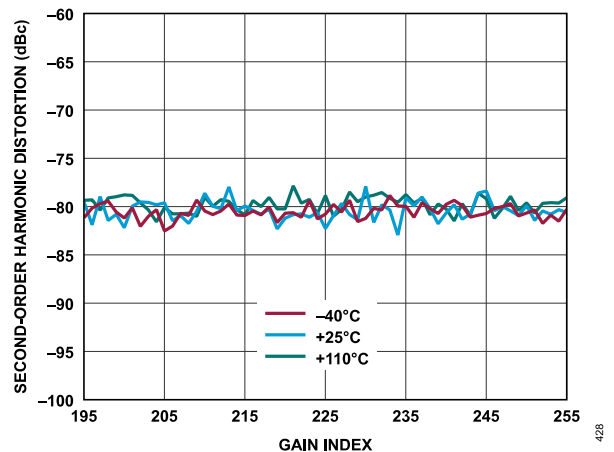

Figure 289. Receiver Second-Order Harmonic Distortion vs. Gain Index, Baseband Frequency = 2.1 kHz, ADC = Low Power

TYPICAL PERFORMANCE CHARACTERISTICS

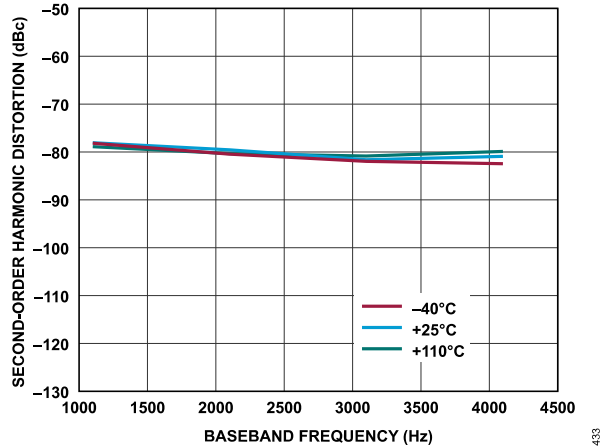

Figure 290. Receiver Second-Order Harmonic Distortion vs. Baseband Frequency, Gain Index = 255, ADC = Low Power

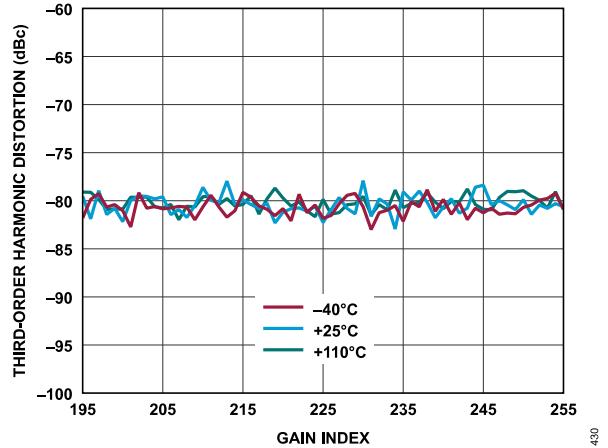

Figure 293. Receiver Third-Order Harmonic Distortion vs. Gain Index, Baseband Frequency = 2.1 kHz, ADC = Low Power

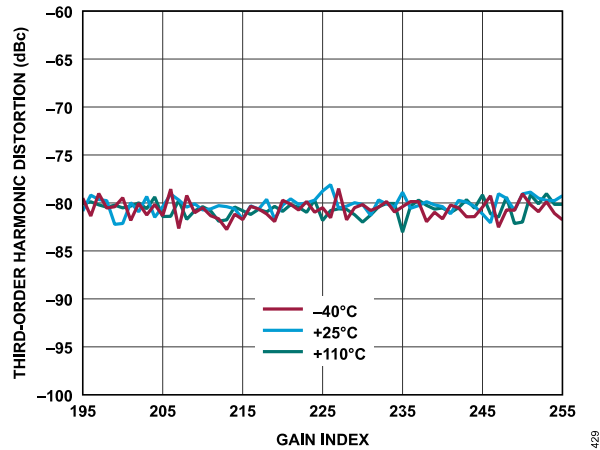

Figure 291. Receiver Third-Order Harmonic Distortion vs. Gain Index, Baseband Frequency = 2.1 kHz, ADC = High Performance

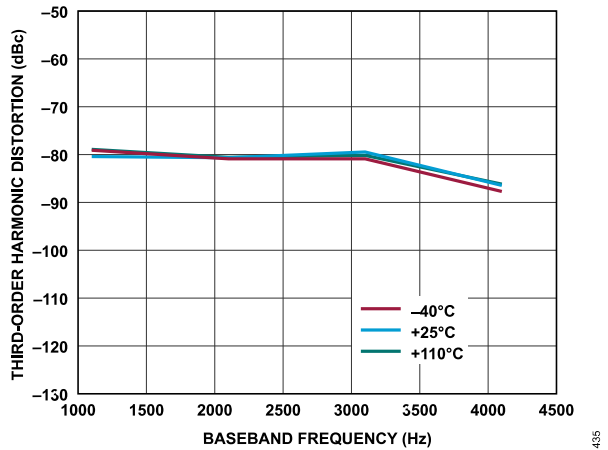

Figure 294. Receiver Third-Order Harmonic Distortion vs. Baseband Frequency, Gain Index = 255, ADC = Low Power

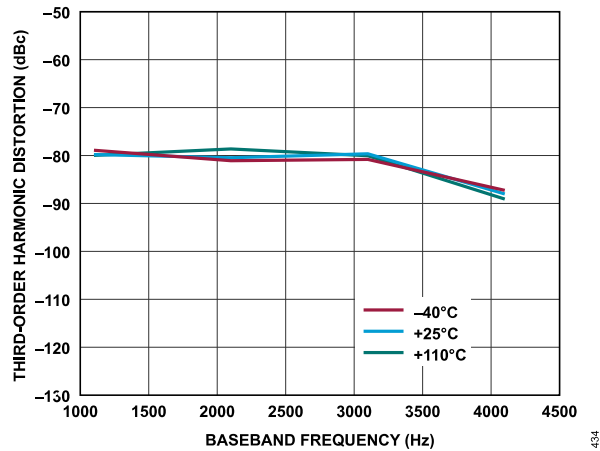

Figure 292. Receiver Third-Order Harmonic Distortion vs. Baseband Frequency, Gain Index = 255, ADC = High Performance

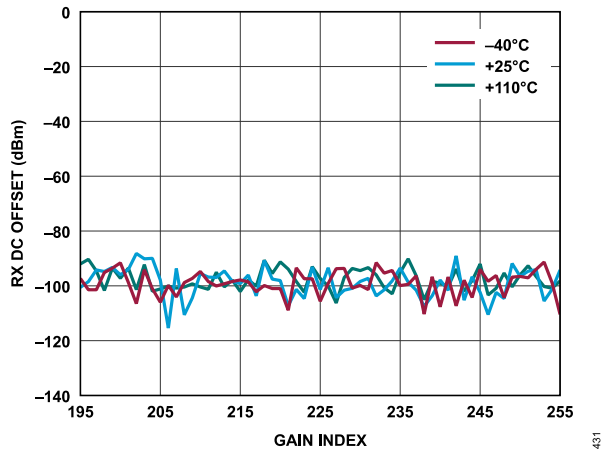

Figure 295. Receiver DC Offset vs. Gain Index, Baseband Frequency = 2.1 kHz, ADC = High Performance

TYPICAL PERFORMANCE CHARACTERISTICS

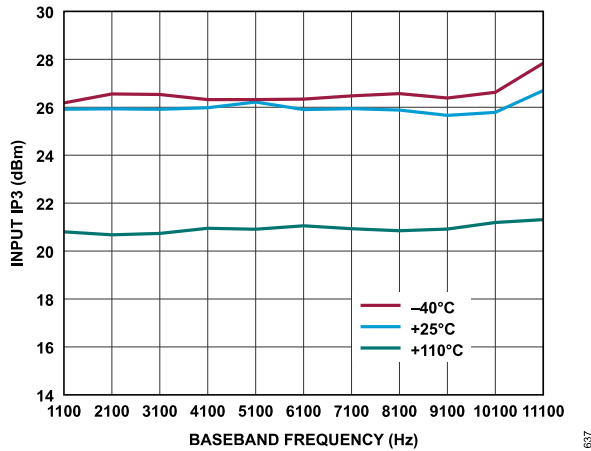

Figure 296. Receiver Input IP3 vs. Baseband Frequency, ADC = High Performance, f_1 = Baseband Frequency + 1 MHz, f_2 = Baseband Frequency + 2 MHz, Gain Index = 255, First-Order TIA with f_{1dB} = 4 MHz, P_{OUT} = -13.6 dBFS at -40°C and +25°C, P_{OUT} = -16.6 dBFS at +110°C

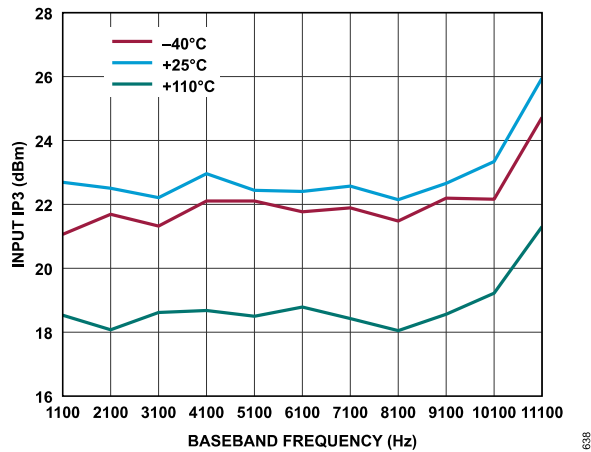

Figure 297. Receiver Input IP3 vs. Baseband Frequency, ADC = Low Power, f_1 = Baseband Frequency + 1 MHz, f_2 = Baseband Frequency + 2 MHz, Gain Index = 255, First-Order TIA with f_{1dB} = 4 MHz, P_{OUT} = -13.6 dBFS at -40°C and +25°C, P_{OUT} = -16.6 dBFS at +110°C

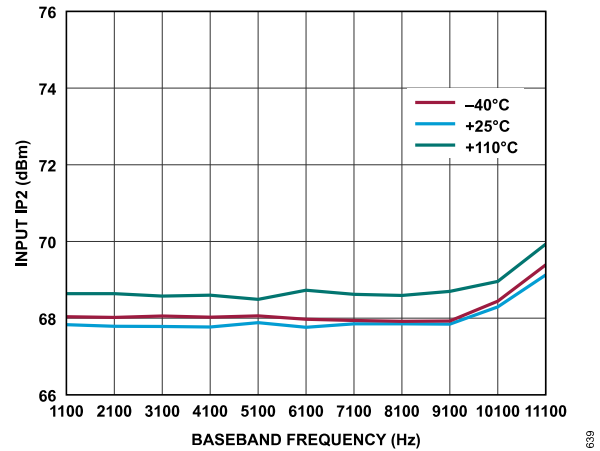

Figure 298. Receiver Input IP2 vs. Baseband Frequency, ADC = High Performance, f_1 = Baseband Frequency + 1 MHz, f_2 = Baseband Frequency + 2 MHz, Gain Index = 255, First-Order TIA with f_{3dB} = 4 MHz, P_{OUT} = -11.6 dBFS

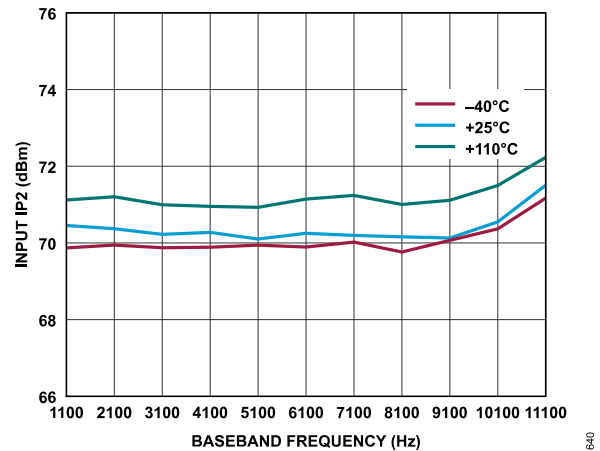

Figure 299. Receiver Input IP2 vs. Baseband Frequency, ADC = Low Power, f_1 = Baseband Frequency + 1 MHz, f_2 = Baseband Frequency + 2 MHz, Gain Index = 255, First-Order TIA with f_{3dB} = 4 MHz, P_{OUT} = -11.6 dBFS

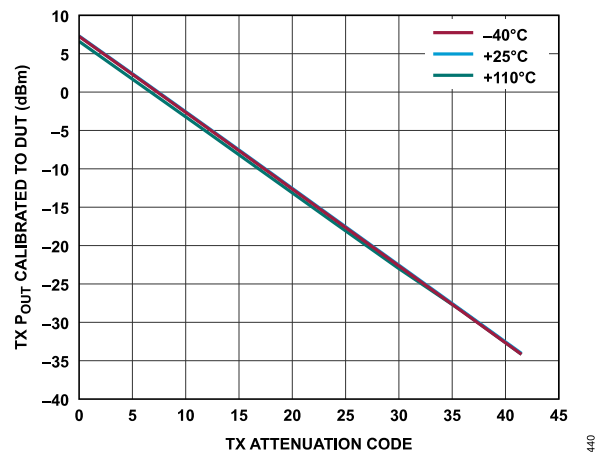

Figure 300. Transmitter Absolute Power vs. Transmitter Attenuation Code, Baseband Frequency = 2.1 kHz, Backoff = 0.2 dBFS

TYPICAL PERFORMANCE CHARACTERISTICS

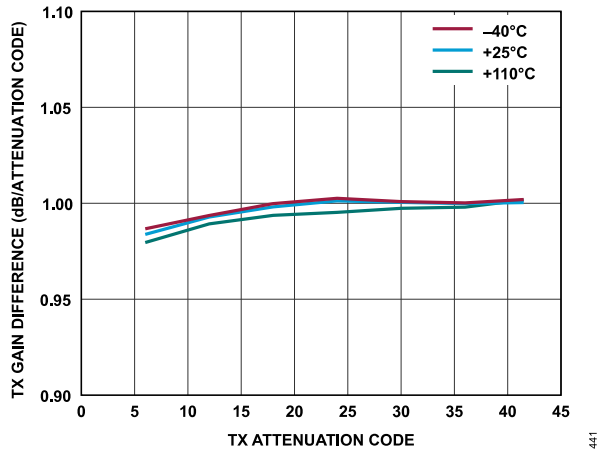

Figure 301. Transmitter Attenuation Delta (Error) vs. Transmitter Attenuation Code, Baseband Frequency = 2.1 kHz, Backoff = 0.2 dBFS

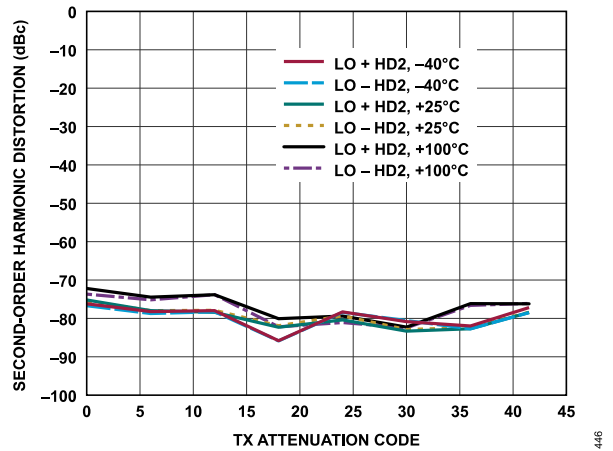

Figure 304. Transmitter Second-Order Harmonic Distortion vs. Transmitter Attenuation Code, Baseband Frequency = 2.1 kHz, Backoff = 0.2 dBFS

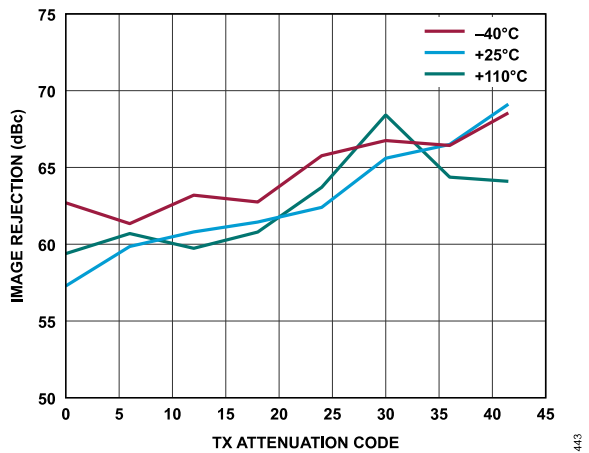

Figure 302. Transmitter Image Rejection vs. Transmitter Attenuation Code, Baseband Frequency = 2.1 kHz, Backoff = 0.2 dBFS, Initialization Calibration Only

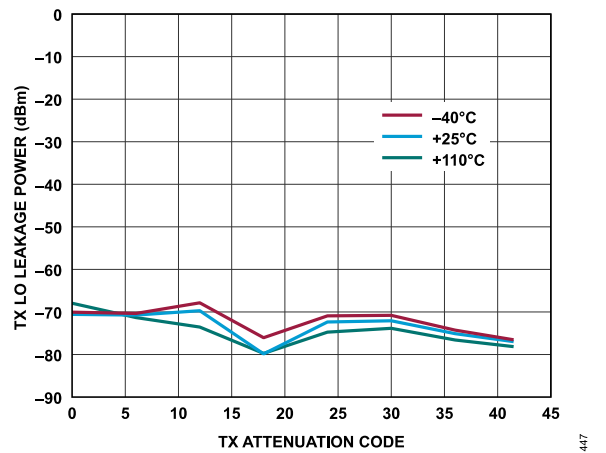

Figure 305. Transmitter LO Leakage Power vs. Transmitter Attenuation Code, Baseband Frequency = 2.1 kHz, Backoff = 6 dBFS, Initialization Calibration Only

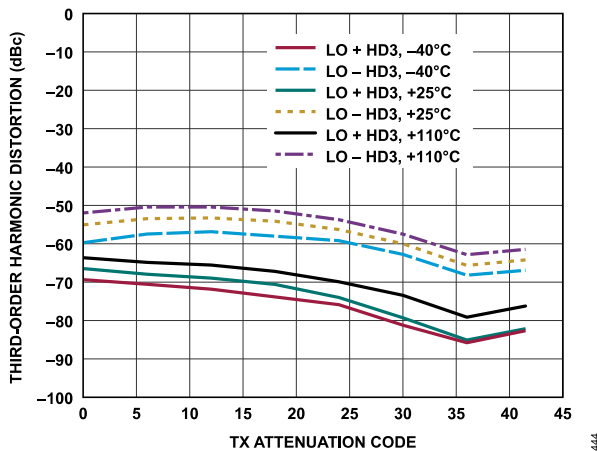

Figure 303. Transmitter Third-Order Harmonic Distortion vs. Transmitter Attenuation Code, Baseband Frequency = 2.1 kHz, Backoff = 0.2 dBFS

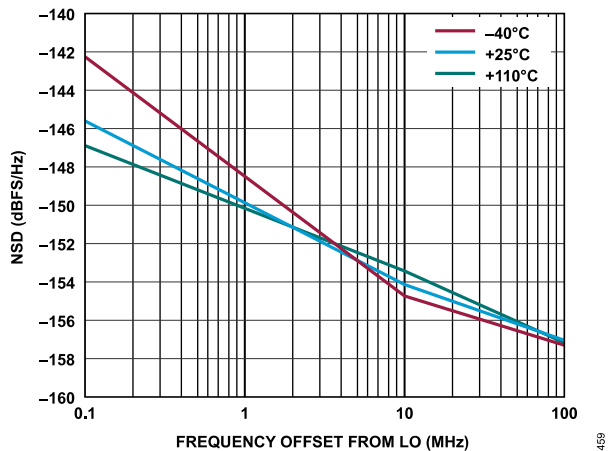

Figure 306. Transmitter NSD vs. Frequency Offset from LO, Baseband Frequency = 2.1 kHz, Transmitter Channel = Channel 1

TYPICAL PERFORMANCE CHARACTERISTICS

3500 MHz LO

The temperature settings refer to the die temperature. All LO frequencies set to 3500 MHz, unless otherwise noted.

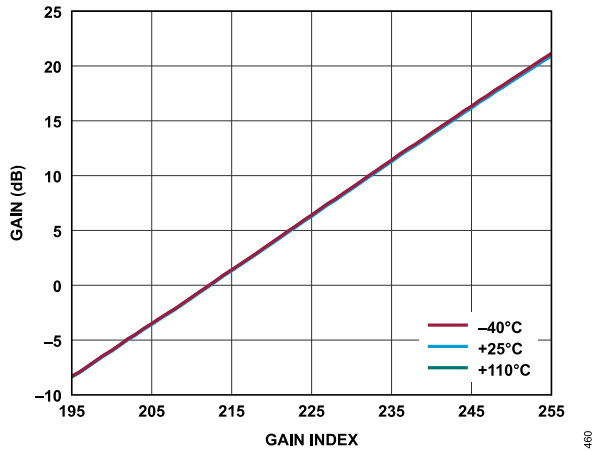

Figure 307. Receiver Absolute Gain (Complex) vs. Gain Index, Baseband Frequency = 2.1 kHz, ADC = High Performance, $P_{OUT} = -9.6$ dBFS

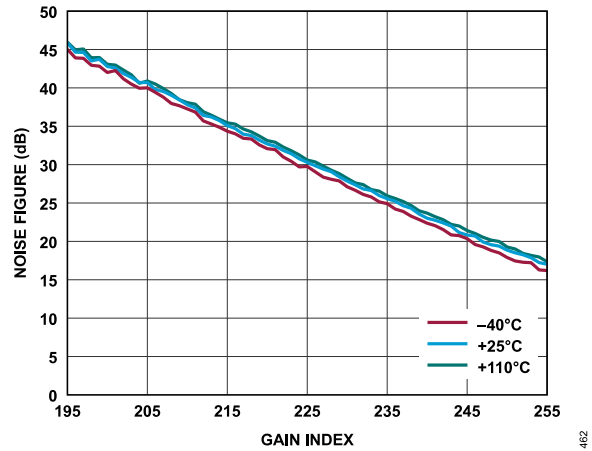

Figure 310. Receiver Noise Figure vs. Gain Index, Baseband Frequency = 2.1 kHz, ADC = Low Power

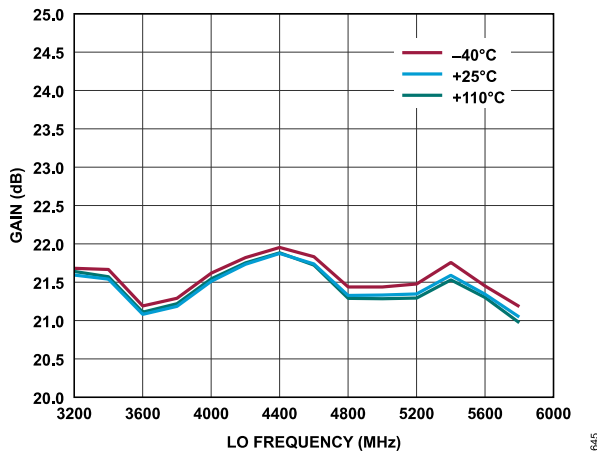

Figure 308. Receiver Absolute Gain (Complex) vs. LO Frequency, Baseband Frequency = 2.1 kHz, ADC = High Performance, $P_{OUT} = -9.6$ dBFS

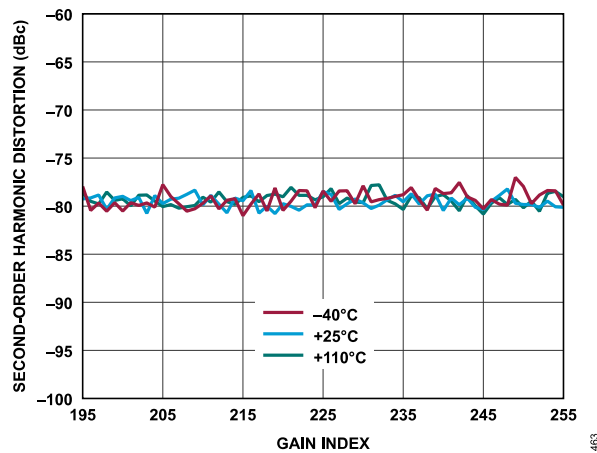

Figure 311. Receiver Second-Order Harmonic Distortion vs. Gain Index, Baseband Frequency = 2.1 kHz, ADC = High Performance

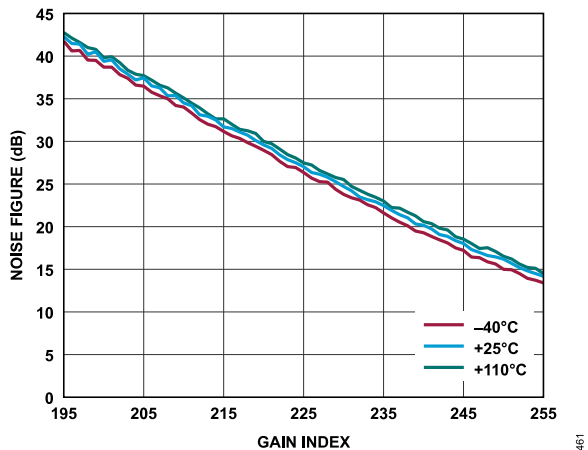

Figure 309. Receiver Noise Figure vs. Gain Index, Baseband Frequency = 2.1 kHz, ADC = High Performance

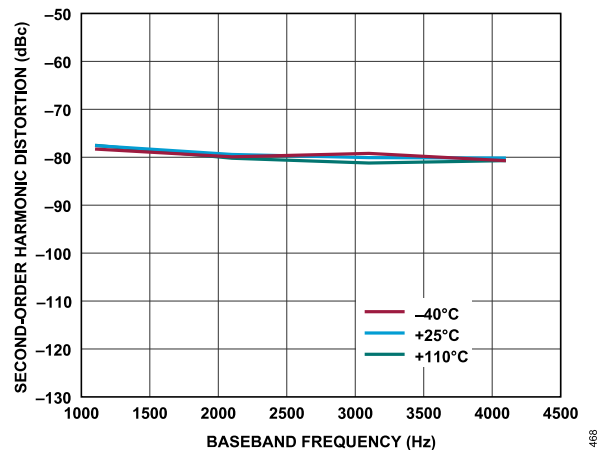

Figure 312. Receiver Second-Order Harmonic Distortion vs. Baseband Frequency, Gain Index = 255, ADC = High Performance

TYPICAL PERFORMANCE CHARACTERISTICS

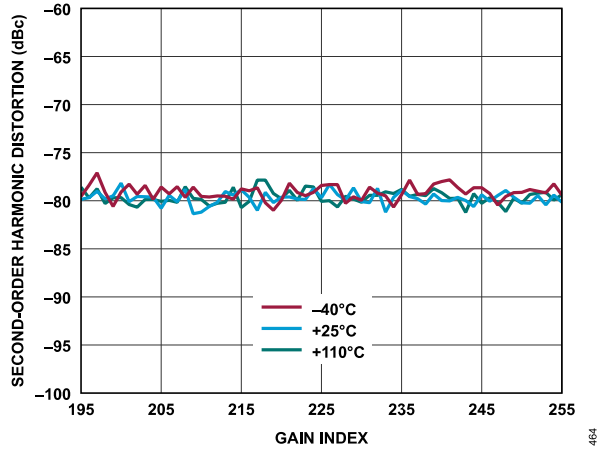

Figure 313. Receiver Second-Order Harmonic Distortion vs. Gain Index, Baseband Frequency = 2.1 kHz, ADC = Low Power

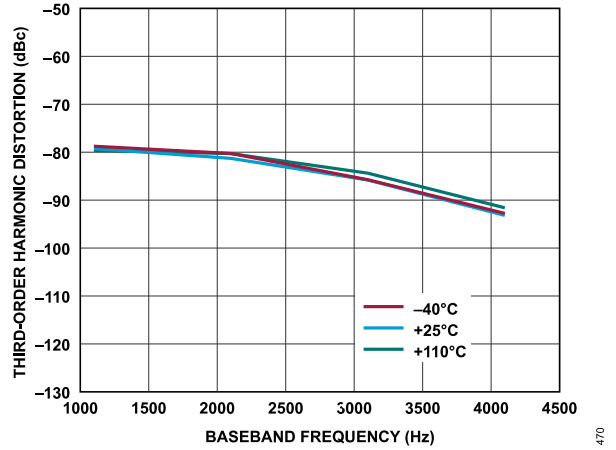

Figure 316. Receiver Third-Order Harmonic Distortion vs. Baseband Frequency, Gain Index = 255, ADC = High Performance

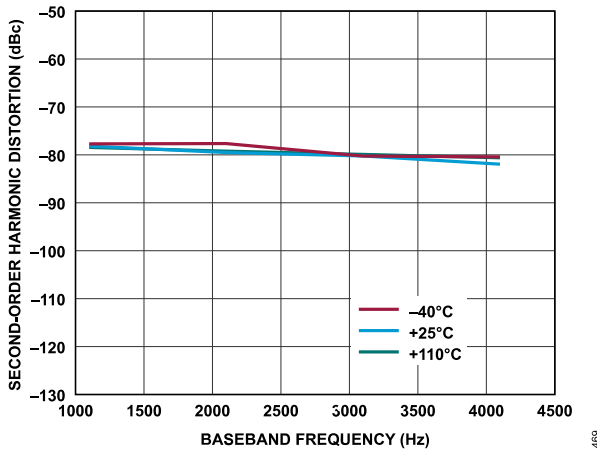

Figure 314. Receiver Second-Order Harmonic Distortion vs. Baseband Frequency, Gain Index = 255, ADC = Low Power

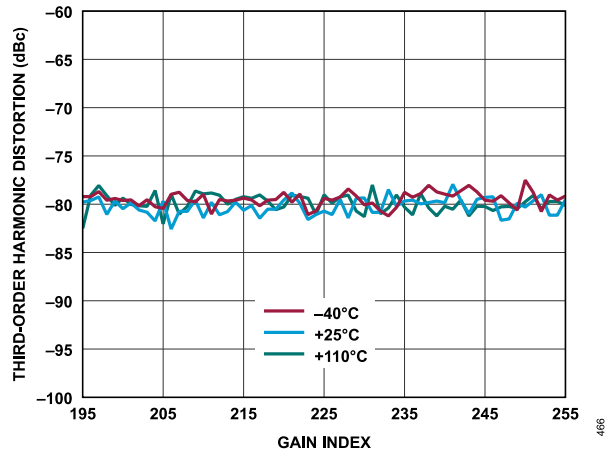

Figure 317. Receiver Third-Order Harmonic Distortion vs. Gain Index, Baseband Frequency = 2.1 kHz, ADC = Low Power

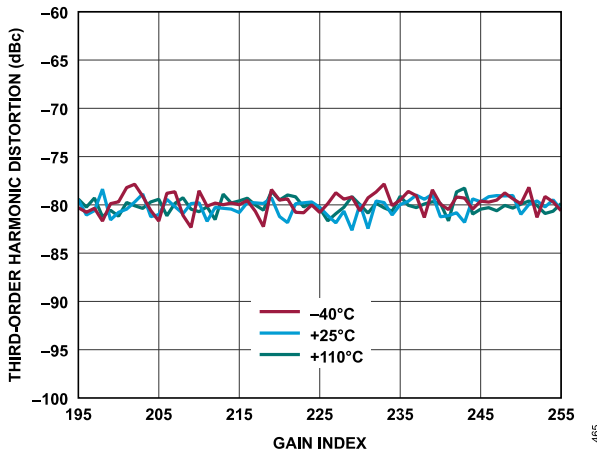

Figure 315. Receiver Third-Order Harmonic Distortion vs. Gain Index, Baseband Frequency = 2.1 kHz, ADC = High Performance

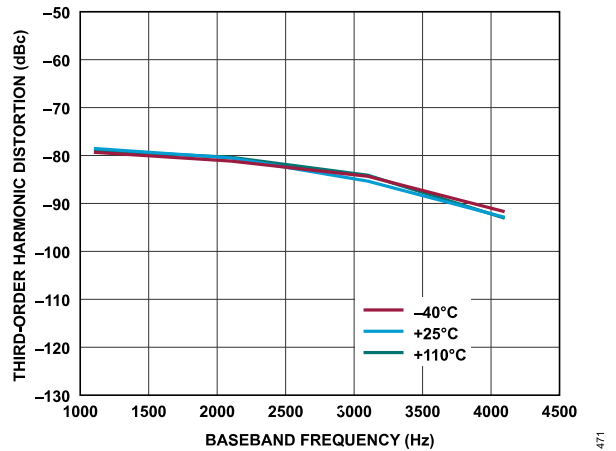

Figure 318. Receiver Third-Order Harmonic Distortion vs. Baseband Frequency, Gain Index = 255, ADC = Low Power

TYPICAL PERFORMANCE CHARACTERISTICS

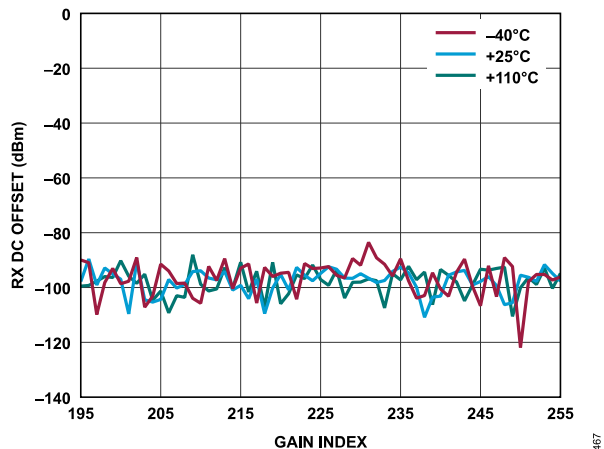

Figure 319. Receiver DC Offset vs. Gain Index, Baseband Frequency = 2.1 kHz, ADC = High Performance

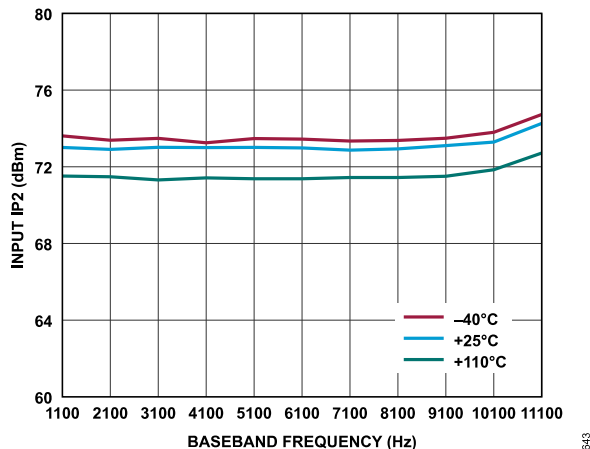

Figure 322. Receiver Input IP2 vs. Baseband Frequency, ADC = High Performance, f_1 = Baseband Frequency + 1 MHz, f_2 = Baseband Frequency + 2 MHz, Gain Index = 255, First-Order TIA with $f_{3dB} = 4$ MHz, $P_{OUT} = -6.6$ dBFS

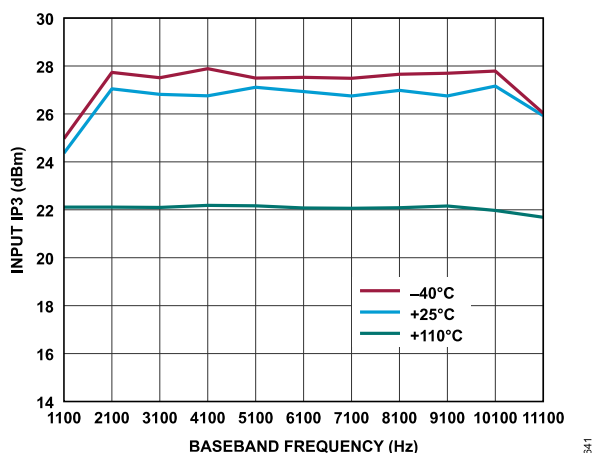

Figure 330. Receiver Input IP3 vs. Baseband Frequency, ADC = High Performance, f_1 = Baseband Frequency + 1 MHz, f_2 = Baseband Frequency + 2 MHz, Gain Index = 255, First-Order TIA with $f_{1dB} = 4$ MHz, $P_{OUT} = -12.6$ dBFS at -40°C and $+25^\circ\text{C}$, $P_{OUT} = -15.6$ dBFS at $+110^\circ\text{C}$

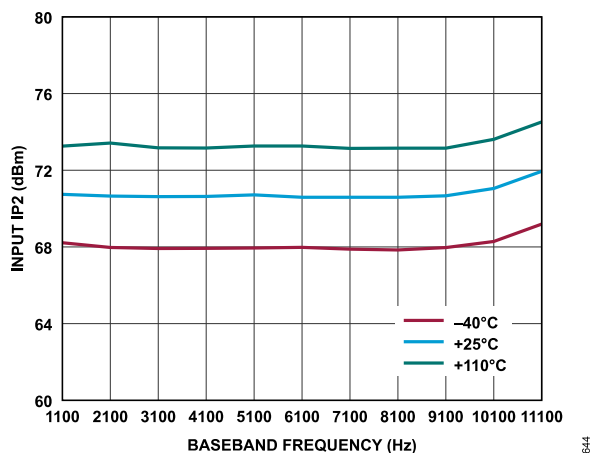

Figure 323. Receiver Input IP2 vs. Baseband Frequency, ADC = Low Power, f_1 = Baseband Frequency + 1 MHz, f_2 = Baseband Frequency + 2 MHz, Gain Index = 255, First-Order TIA with $f_{3dB} = 4$ MHz, $P_{OUT} = -6.6$ dBFS

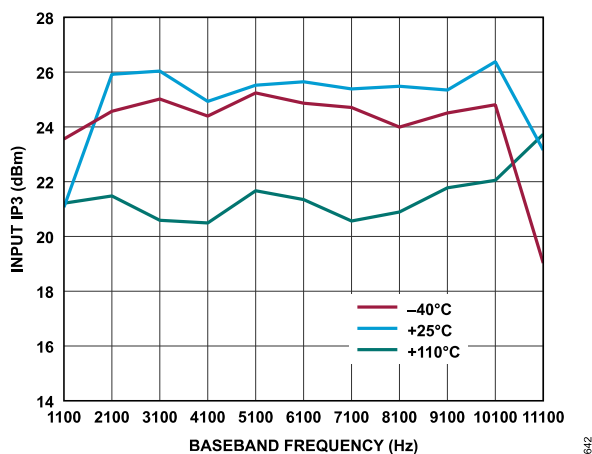

Figure 331. Receiver Input IP3 vs. Baseband Frequency, ADC = Low Power, f_1 = Baseband Frequency + 1 MHz, f_2 = Baseband Frequency + 2 MHz, Gain Index = 255, First-Order TIA with $f_{1dB} = 4$ MHz, $P_{OUT} = -12.6$ dBFS at -40°C and $+25^\circ\text{C}$, $P_{OUT} = -15.6$ dBFS at $+110^\circ\text{C}$

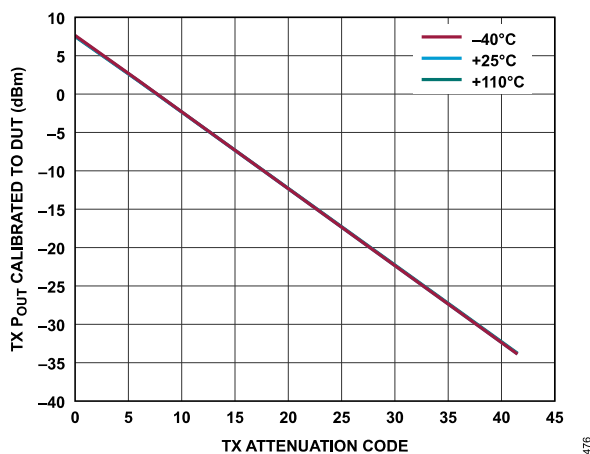

Figure 324. Transmitter Absolute Power vs. Transmitter Attenuation Code, Baseband Frequency = 2.1 kHz, Backoff = 0.2 dBFS

TYPICAL PERFORMANCE CHARACTERISTICS

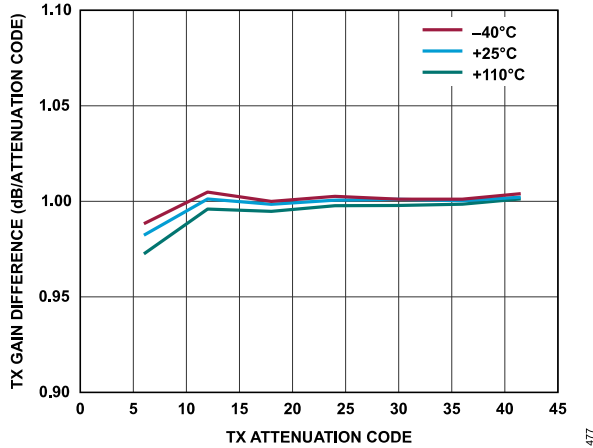

Figure 325. Transmitter Attenuation Delta (Error) vs. Transmitter Attenuation Code, Baseband Frequency = 2.1 kHz, Backoff = 0.2 dBFS

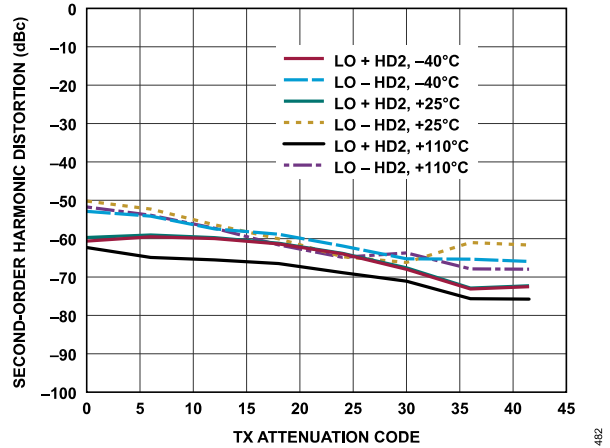

Figure 328. Transmitter Second-Order Harmonic Distortion vs. Transmitter Attenuation Code, Baseband Frequency = 2.1 kHz, Backoff = 0.2 dBFS

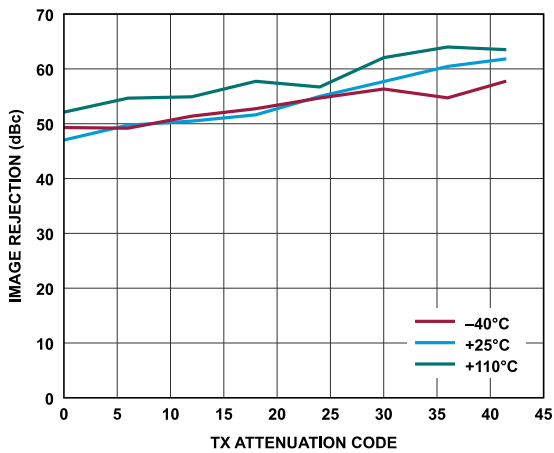

Figure 326. Transmitter Image Rejection vs. Transmitter Attenuation Code, Baseband Frequency = 2.1 kHz, Backoff = 0.2 dBFS, Initialization Calibration Only

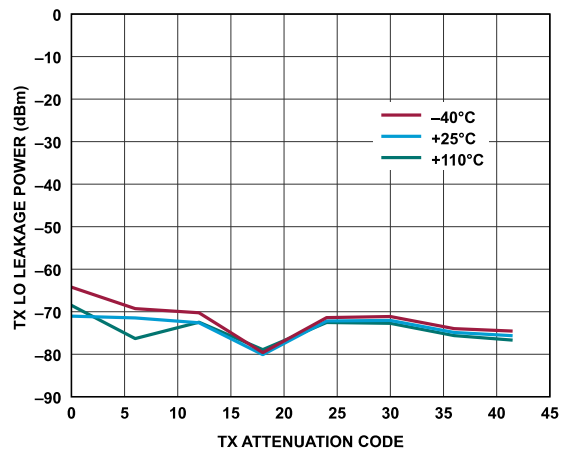

Figure 329. Transmitter LO Leakage Power vs. Transmitter Attenuation Code, Baseband Frequency = 2.1 kHz, Backoff = 6 dBFS, Initialization Calibration Only

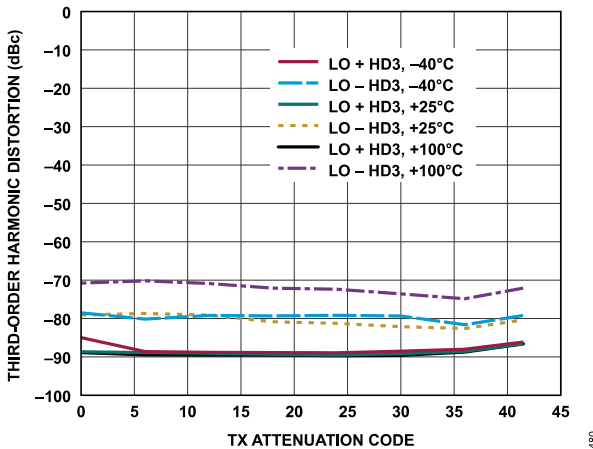

Figure 327. Transmitter Third-Order Harmonic Distortion vs. Transmitter Attenuation Code, Baseband Frequency = 2.1 kHz, Backoff = 0.2 dBFS

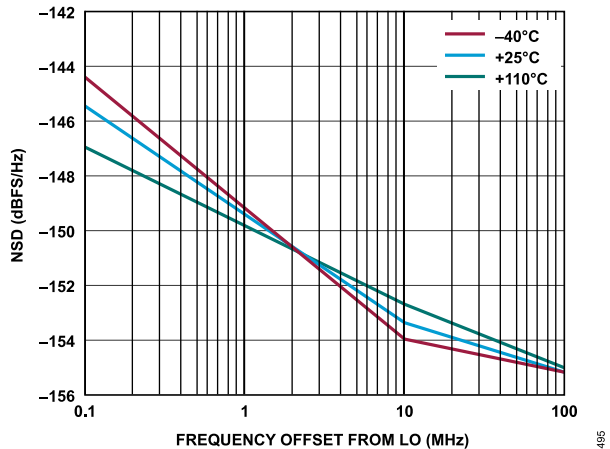

Figure 330. Transmitter NSD vs. Frequency Offset from LO, Baseband Frequency = 2.1 kHz, Transmitter Channel = Channel 1

TYPICAL PERFORMANCE CHARACTERISTICS

5800 MHz LO

The temperature settings refer to the die temperature. All LO frequencies set to 5800 MHz, unless otherwise noted.

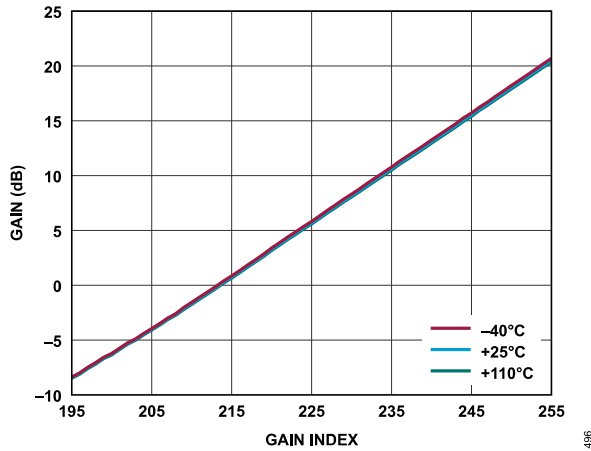

Figure 331. Receiver Absolute Gain (Complex) vs. Gain Index, Baseband Frequency = 2.1 kHz, ADC = High Performance, $P_{OUT} = -9.6$ dBFS

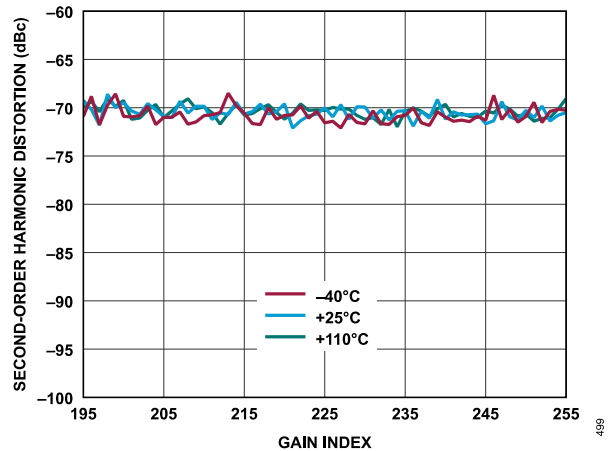

Figure 334. Receiver Second-Order Harmonic Distortion vs. Gain Index, Baseband Frequency = 2.1 kHz, ADC = High Performance

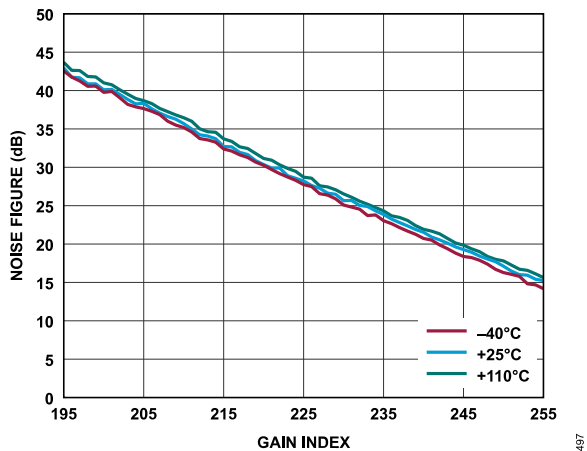

Figure 332. Receiver Noise Figure vs. Gain Index, Baseband Frequency = 2.1 kHz, ADC = High Performance

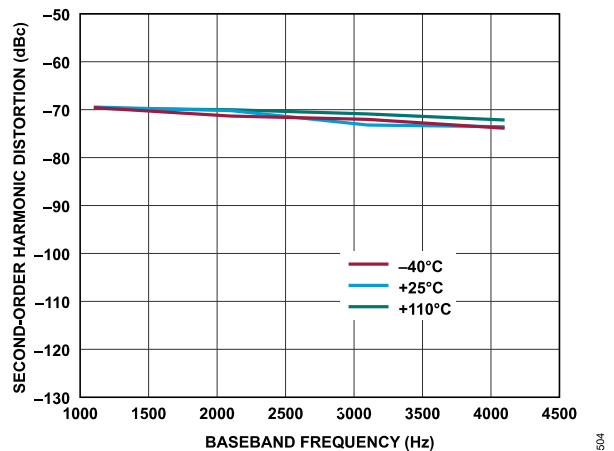

Figure 335. Receiver Second-Order Harmonic Distortion vs. Baseband Frequency, Gain Index = 255, ADC = High Performance

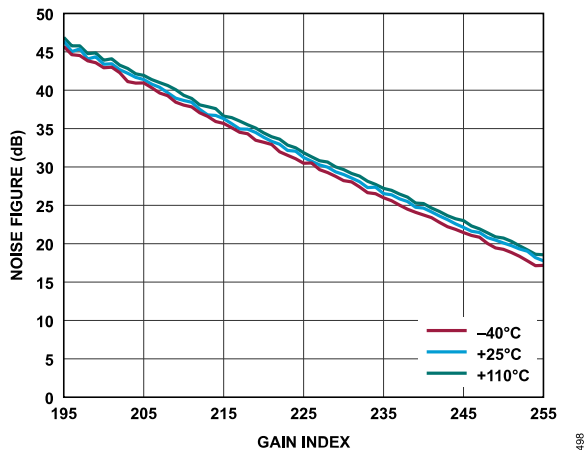

Figure 333. Receiver Noise Figure vs. Gain Index, Baseband Frequency = 2.1 kHz, ADC = Low Power

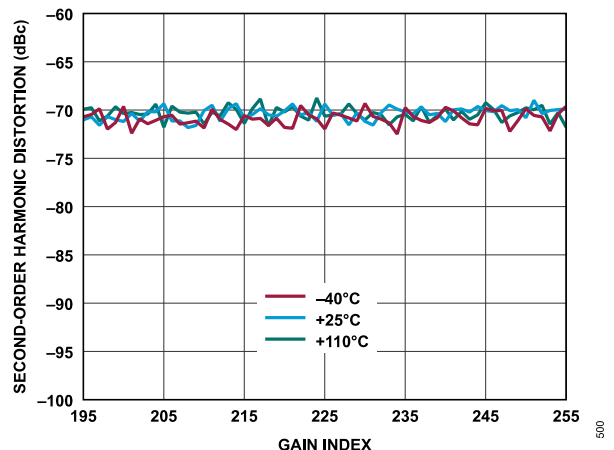

Figure 336. Receiver Second-Order Harmonic Distortion vs. Gain Index, Baseband Frequency = 2.1 kHz, ADC = Low Power

TYPICAL PERFORMANCE CHARACTERISTICS

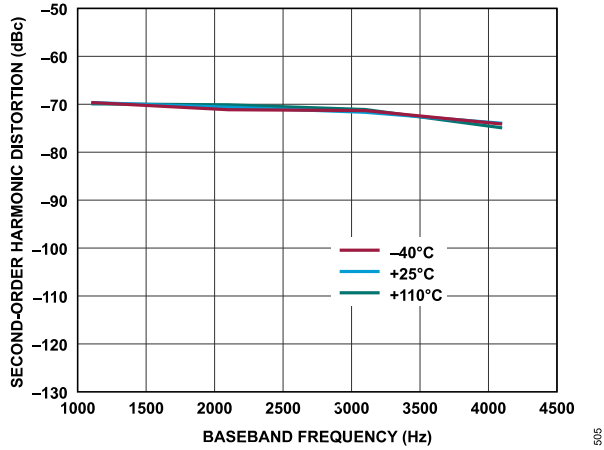

Figure 337. Receiver Second-Order Harmonic Distortion vs. Baseband Frequency, Gain Index = 255, ADC = Low Power

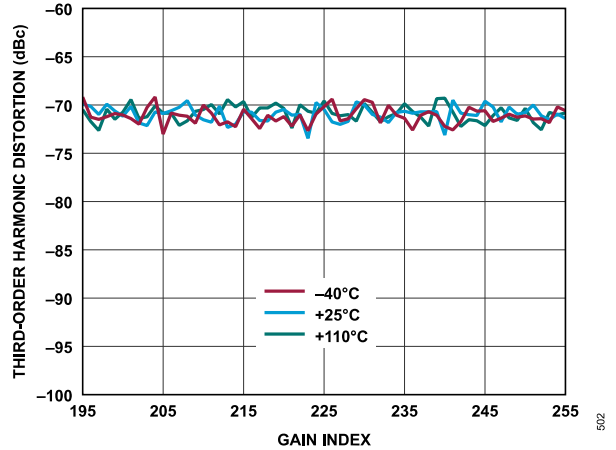

Figure 340. Receiver Third-Order Harmonic Distortion vs. Gain Index, Baseband Frequency = 2.1 kHz, ADC = Low Power

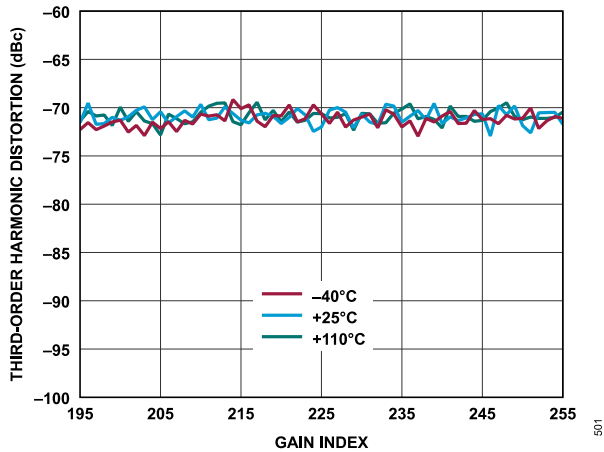

Figure 338. Receiver Third-Order Harmonic Distortion vs. Gain Index, Baseband Frequency = 2.1 kHz, ADC = High Performance

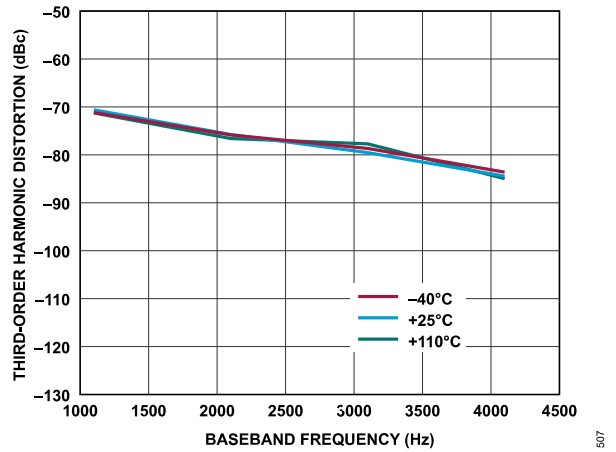

Figure 341. Receiver Third-Order Harmonic Distortion vs. Baseband Frequency, Gain Index = 255, ADC = Low Power

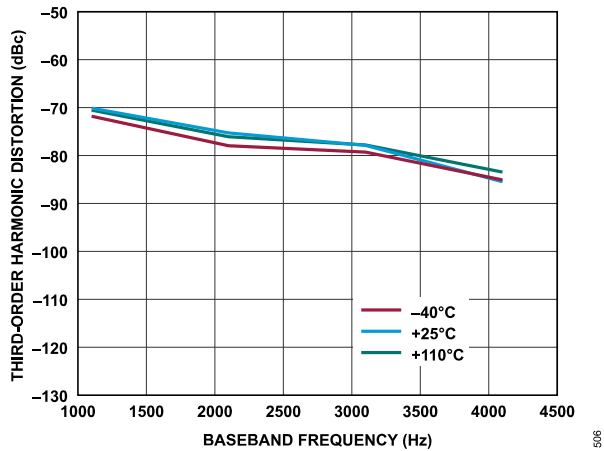

Figure 339. Receiver Third-Order Harmonic Distortion vs. Baseband Frequency, Gain Index = 255, ADC = High Performance

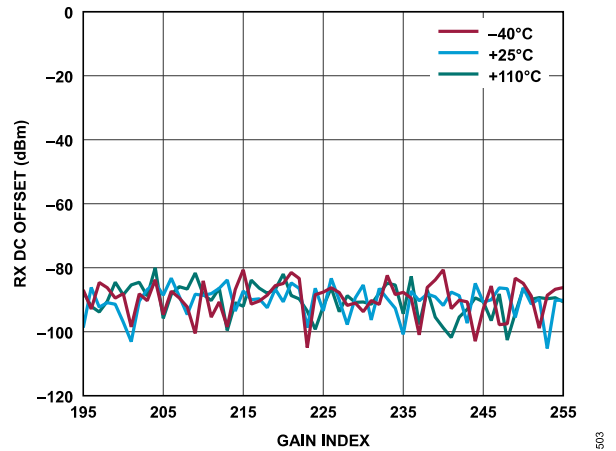

Figure 342. Receiver DC Offset vs. Gain Index, Baseband Frequency = 2.1 kHz, ADC = High Performance

TYPICAL PERFORMANCE CHARACTERISTICS

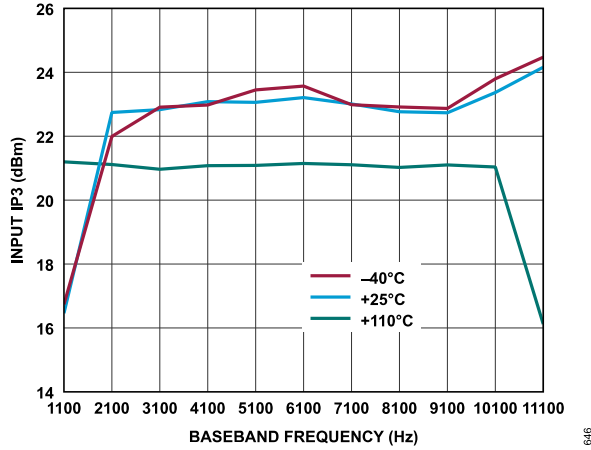

Figure 343. Receiver Input IP3 vs. Baseband Frequency, ADC = High Performance, f_1 = Baseband Frequency + 1 MHz, f_2 = Baseband Frequency + 2 MHz, Gain Index = 255, First-Order TIA with f_{1dB} = 4 MHz, P_{OUT} = -14 dBFS at -40°C and +25°C, P_{OUT} = -12 dBFS at +110°C

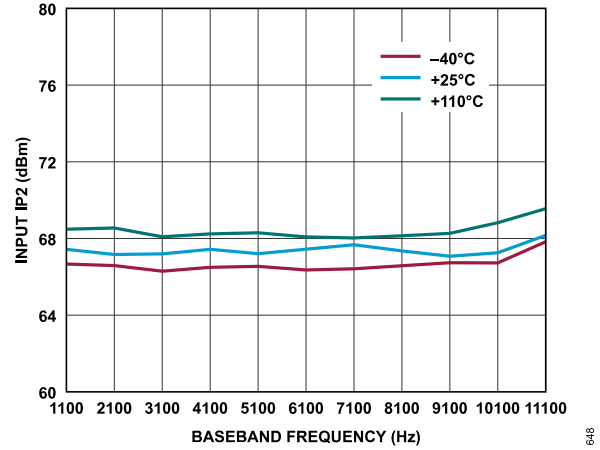

Figure 345. Receiver Input IP2 vs. Baseband Frequency, ADC = High Performance, f_1 = Baseband Frequency + 1 MHz, f_2 = Baseband Frequency + 2 MHz, Gain Index = 255, First-Order TIA with f_{3dB} = 4 MHz, P_{OUT} = -6.6 dBFS

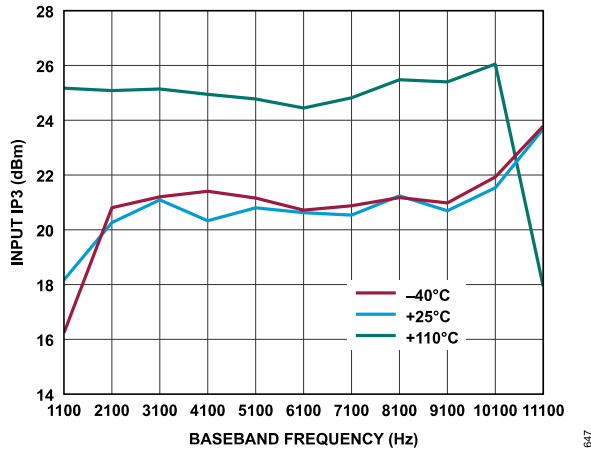

Figure 344. Receiver Input IP3 vs. Baseband Frequency, ADC = Low Power, f_1 = Baseband Frequency + 1 MHz, f_2 = Baseband Frequency + 2 MHz, Gain Index = 255, First-Order TIA with f_{1dB} = 4 MHz, P_{OUT} = -14 dBFS at -40°C and +25°C, P_{OUT} = -12 dBFS at +110°C

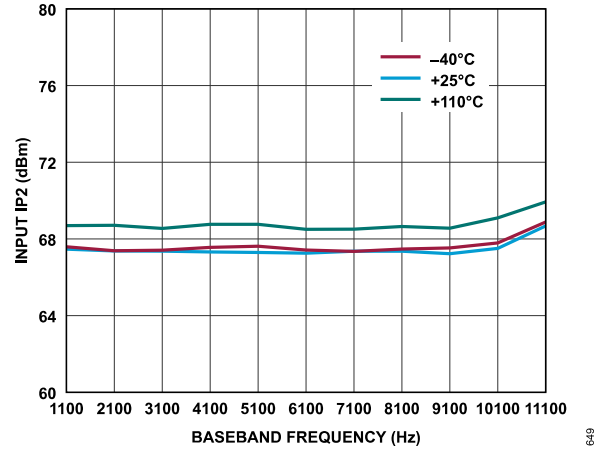

Figure 346. Receiver Input IP2 vs. Baseband Frequency, ADC = Low Power, f_1 = Baseband Frequency + 1 MHz, f_2 = Baseband Frequency + 2 MHz, Gain Index = 255, First-Order TIA with f_{3dB} = 4 MHz, P_{OUT} = -6.6 dBFS

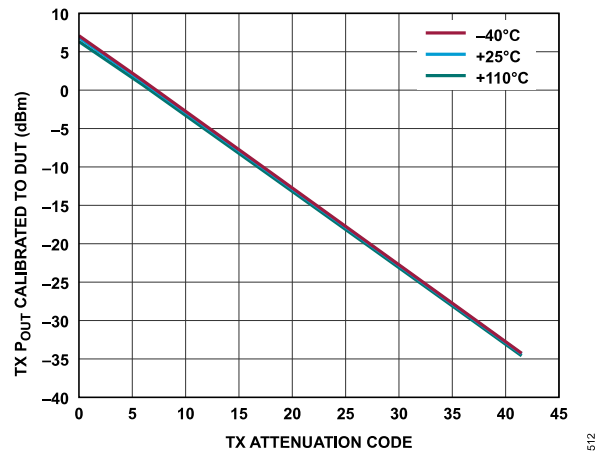

Figure 347. Transmitter Absolute Power vs. Transmitter Attenuation Code, Baseband Frequency = 2.1 kHz, Backoff = 0.2 dBFS

TYPICAL PERFORMANCE CHARACTERISTICS

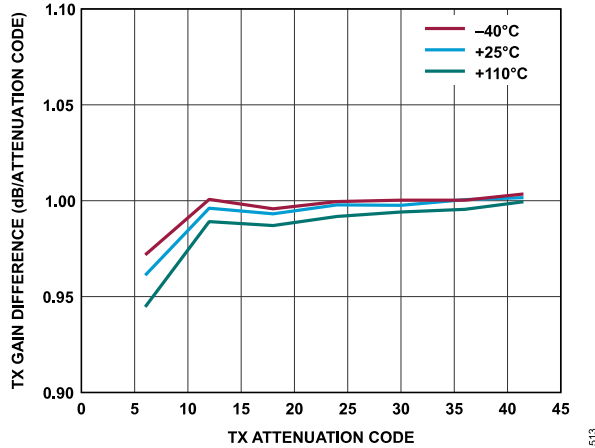

Figure 348. Transmitter Attenuation Delta (Error) vs. Transmitter Attenuation Code, Baseband Frequency = 2.1 kHz, Backoff = 0.2 dBFS

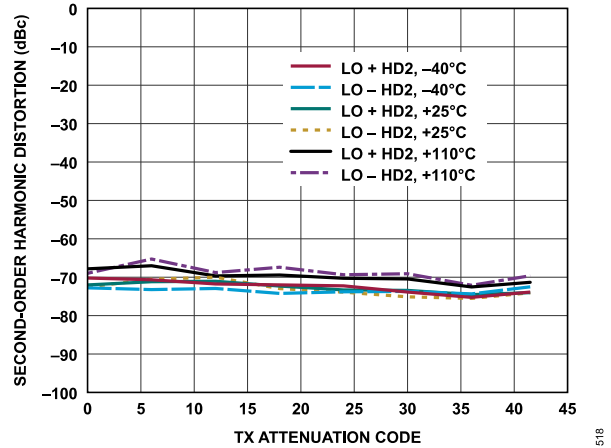

Figure 351. Transmitter Second-Order Harmonic Distortion vs. Transmitter Attenuation Code, Baseband Frequency = 2.1 kHz, Backoff = 0.2 dBFS

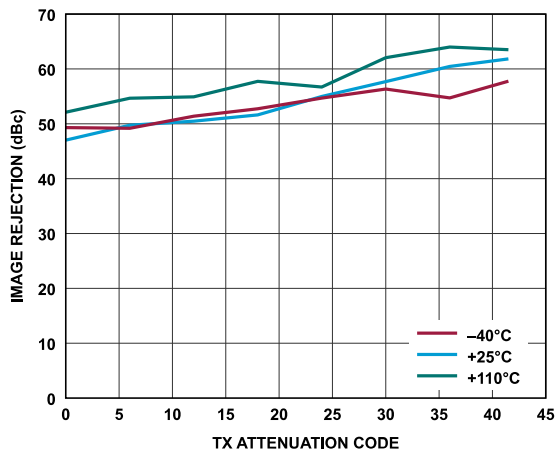

Figure 349. Transmitter Image Rejection vs. Transmitter Attenuation Code, Baseband Frequency = 2.1 kHz, Backoff = 0.2 dBFS, Initialization Calibration Only

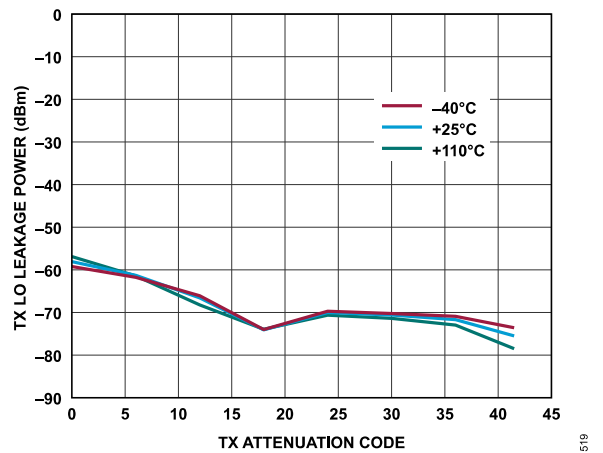

Figure 352. Transmitter LO Leakage Power vs. Transmitter Attenuation Code, Baseband Frequency = 2.1 kHz, Backoff = 6 dBFS, Initialization Calibration Only

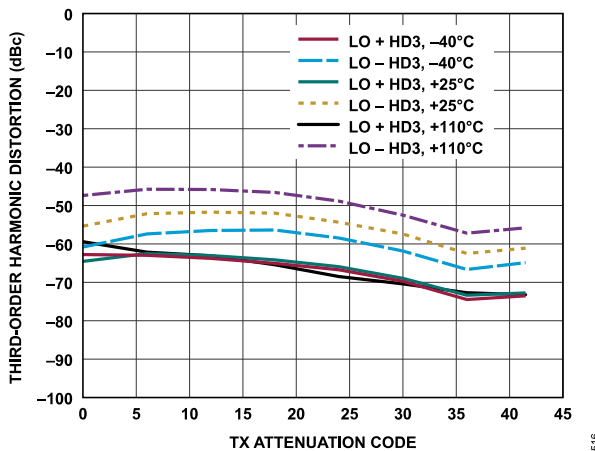

Figure 350. Transmitter Third-Order Harmonic Distortion vs. Transmitter Attenuation Code, Baseband Frequency = 2.1 kHz, Backoff = 0.2 dBFS

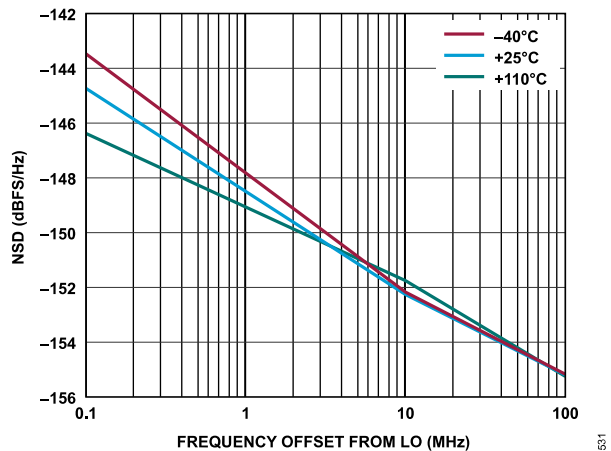

Figure 353. Transmitter NSD vs. Frequency Offset from LO, Baseband Frequency = 2.1 kHz, Transmitter Channel = Channel 1

TYPICAL PERFORMANCE CHARACTERISTICS

PHASE NOISE

PLL bandwidth = 300 kHz. DEV_CLK = 38.4 MHz. Narrow-band or wideband profile with IQ mode. A high performance, low noise, Wenzel type oscillator is used as a reference clock.

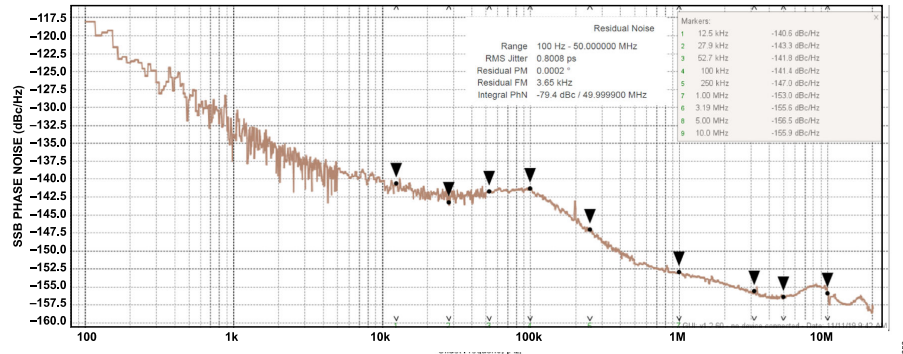

Figure 354. Internal Local Oscillator Phase Noise at 30 MHz LO

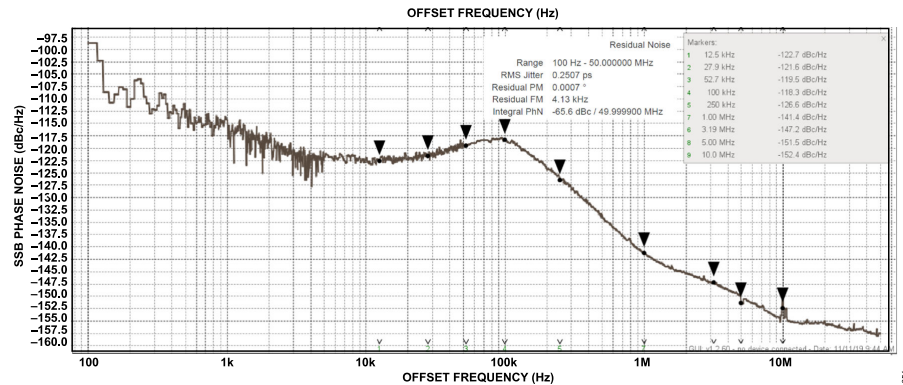

Figure 355. Internal Local Oscillator Phase Noise at 470 MHz LO

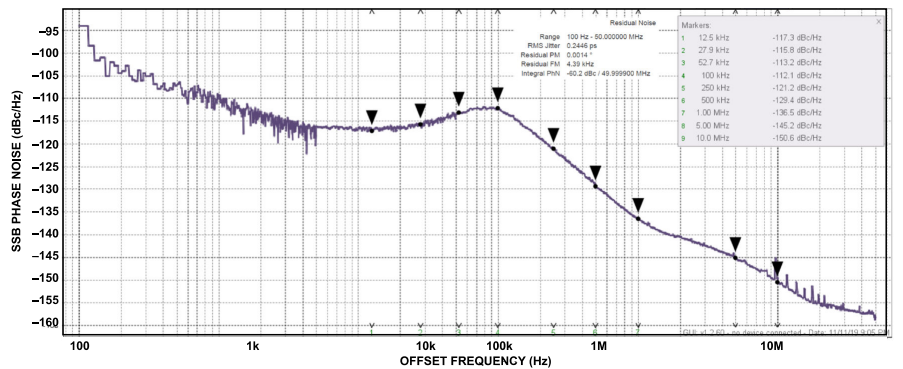

Figure 356. Internal Local Oscillator Phase Noise at 900 MHz LO

TYPICAL PERFORMANCE CHARACTERISTICS

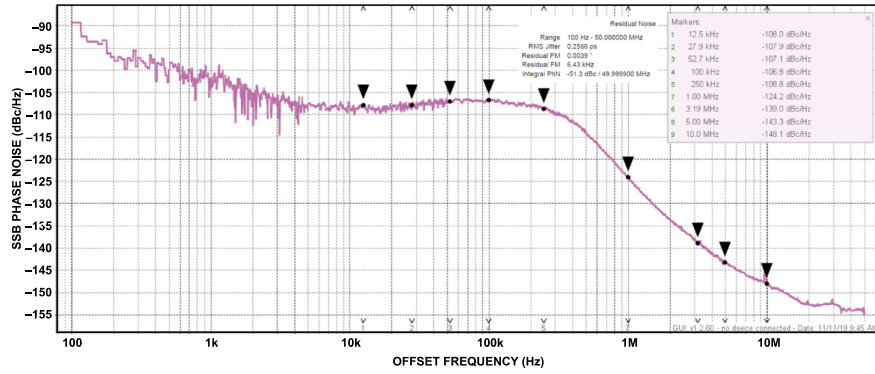

Figure 357. Internal Local Oscillator Phase Noise at 2400 MHz LO

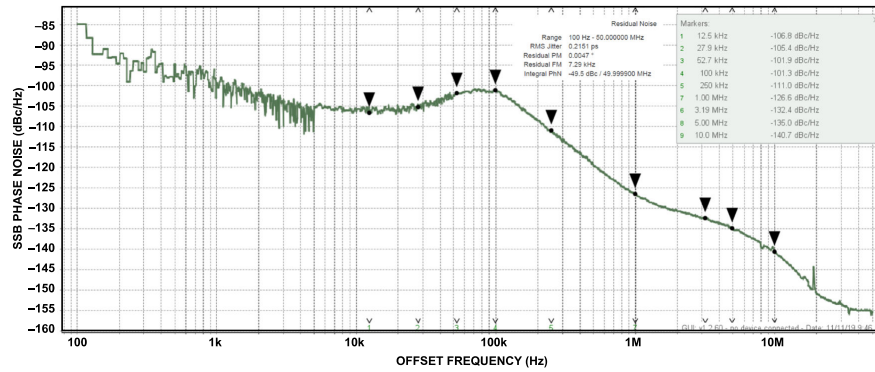

Figure 358. Internal Local Oscillator Phase Noise at 3500 MHz LO

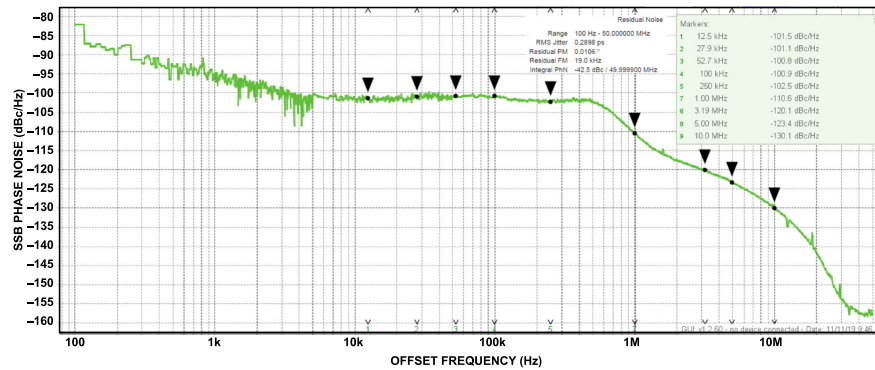

Figure 359. Internal Local Oscillator Phase Noise at 5800 MHz LO

THEORY OF OPERATION

The ADRV9004 is a highly integrated RF transceiver that can be configured for a wide range of applications. The device integrates all RF, mixed-signal, and digital blocks necessary to provide transmit and receive functions in a single device. Programmability allows the two receiver channels and two transmitter channels to be used in TDD and FDD systems for mobile radio and cellular standards.

The ADRV9004 contains serial interface links that consist of LVDS and a CMOS synchronous serial interface (CSSI). Both receiver and transmitter channels provide a low pin count and reliable data interface to a field-programmable gate array (FPGA) or other integrated baseband solutions.

The ADRV9004 provides self calibration for dc offset, LO leakage, and QEC using an integrated microcontroller core to maintain a high performance level under varying temperatures and input signal conditions. Firmware is supplied with the device to schedule all calibrations with no user interaction.

TRANSMITTER

The ADRV9004 uses a direct conversion transmitter architecture that consists of two identical and independently controlled channels

that provide all digital processing, mixed signals, PLLs, and RF blocks necessary to implement a direct conversion system. Refer to [Figure 360](#) for the transmitter data path overview.

The ADRV9004 has an optional, fully programmable, 128-tap FIR. The FIR output is sent to a series of interpolation filters that provide additional filtering and data rate interpolation prior to reaching the DAC. Each DAC has an adjustable sample rate and is linear up to full scale.

The DAC output produces baseband analog signals. The I and Q signals are first filtered to remove sampling artifacts and then fed to the upconversion mixers. At the mixer stage, the I and Q signals are recombined and modulated onto the carrier frequency for transmission to the output stage. Each transmit chain provides a wide attenuation adjustment range with fine granularity to help designers optimize the signal-to-noise ratio (SNR).

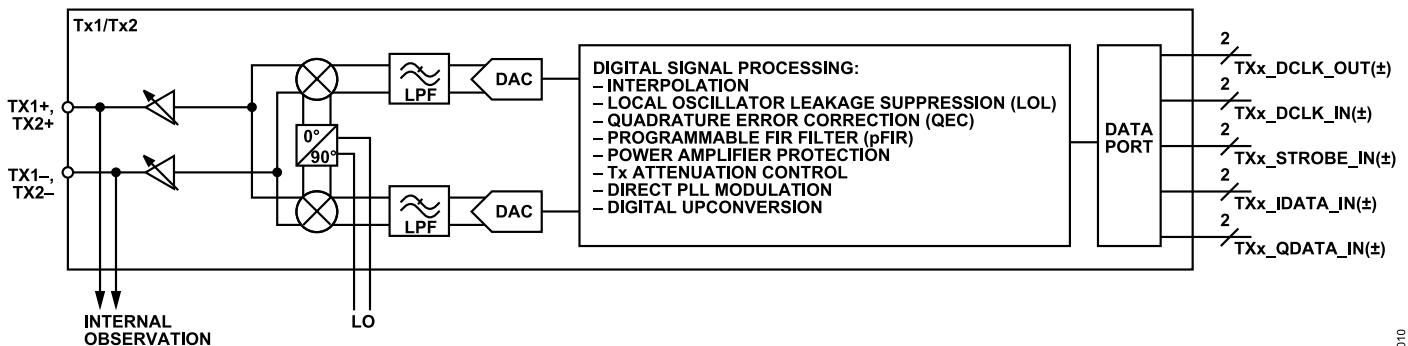

Figure 360. Transmitter Architecture

THEORY OF OPERATION

RECEIVER

Figure 361 shows a simplified block diagram of the ADRV9004 receiver. It is a fully integrated, direct conversion, low IF receiver signal chain. The receiver subsystem consists of a resistive input network for gain control followed by a current mode passive mixer. The output current of the mixer is converted to a voltage by a transimpedance amplifier and then digitized. There are two sets of ADCs, a high performance Σ - Δ ADC and a low power ADC. The digital baseband that provides the required filtering and decimation follows these ADCs.

There are two RF inputs for each receiver to match different bands in one reference design. The mixer architecture is linear and inherently wideband, which facilitates impedance matching. The differential input impedance of the receiver inputs is 100 Ω .

To achieve gain control, a programmed gain index map is implemented. This gain map distributes attenuation among the various receiver blocks for optimal performance at each power level. The gain range is 34 dB. Additional support is available for both automatic and manual gain control modes.

The receive LPFs can be reconfigured to help provide antialias filtering and improve out of band blockers. The ADRV9004 is a wideband architecture transceiver that relies on the ADC high dynamic range to receive signals and interference at the same time. Filtering provided by the receive LPF attenuates ADC alias images. The receive LPF characteristic is flat and not intended to provide rejection of close in blockers. The baseband filter supports a baseband bandwidth from 5 MHz to 50 MHz.

The receiver includes two ADC pairs. One pair consists of high performance Σ - Δ ADCs to provide maximum interferer tolerance, and the second pair consists of ADCs for significant power reduction. The extra pair of ADCs allow a smart trade-off between power and performance.

The ADC output can be conditioned further by a series of decimation filters and a fully programmable, 128-tap FIR filter with additional decimation settings. The sample rate of each digital filter block automatically adjusts with each change of the decimation factors to produce the desired output data rate.

For standards that demand low phase noise performance, the ADRV9004 can operate in low IF mode. The ADRV9004 can receive signals offset from the carrier, as with an IF downconversion scheme. A digital NCO and mixer that follow the analog receive path can downconvert the IF signal to baseband. Downconverting the signal to baseband allows a lower sample rate on the data bus. The ADRV9004 makes no assumptions about high-side or low-side injection.

Monitor Mode

The ADRV9004 receiver signal chain can be configured to monitor the radio channel signal level in duty cycle detection and sleep fashion. Monitor mode allows the digital baseband processor to power down until the ADRV9004 detects a signal. Monitor mode provides overall system power saving. The timing of detection and sleep mode is fully programmable. Alternatively, the ADRV9004 can be under full control of the baseband processor during monitor mode.

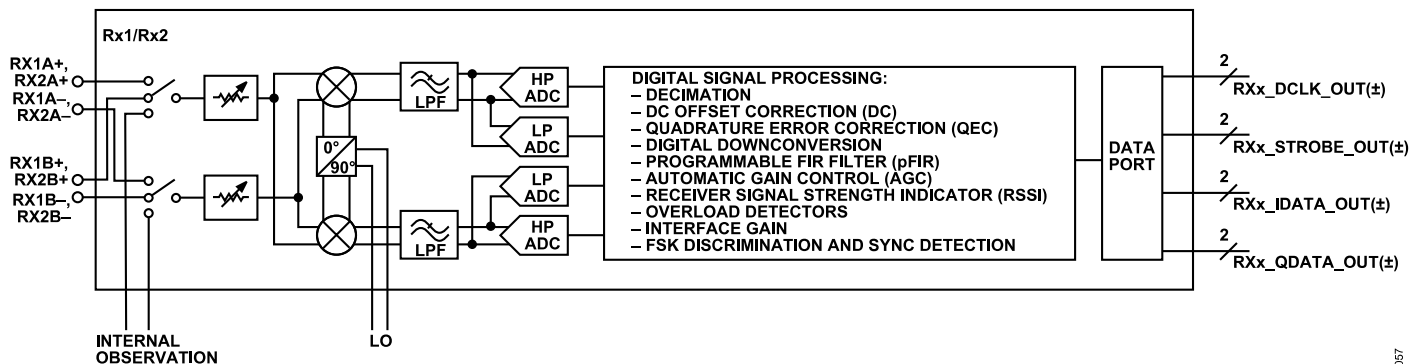

Figure 361. Receiver Architecture

THEORY OF OPERATION

RECEIVER AS AN OBSERVATION RECEIVER

In FDD type applications where only one receiver is used or in the TDD type applications during transmitter time slots, unused receiver inputs can be used to perform transmitter observation. The observation receiver operates in a similar manner to the main receivers.

Use the observation receiver channel to perform the following:

- ▶ Monitor the transmitter channels and implement transmitter local oscillator leakage (LOL) correction and transmitter QEC
- ▶ Monitor signal levels after the power amplifier output for further data processing in the external baseband processor

CLOCK INPUT

The reference clock inputs provide a low frequency clock from which all internal ADRV9004 clocks are derived. The ADRV9004 offers multiple reference input clocking options. The reference input clock pins on the device are labeled DEV_CLK_IN±.

For optimal performance, drive the reference clock differentially via an external source or from an external crystal. If a differential input clock is provided, the clock signal must be ac-coupled with the input range limited from 10 MHz to 1 GHz. The ADRV9004 can also accept an external crystal (XTAL) as a clock source. The frequency range of the supported crystal is between 20 MHz to 80 MHz. The external crystal connection must be dc-coupled.

If a differential clock is not available, a single-ended, ac-coupled, 1 V p-p (maximum) CMOS signal can be applied to the DEV_CLK_IN+ pin with the DEV_CLK_IN- pin unconnected. The maximum clock frequency in this mode is limited to 80 MHz.

SYNTHESIZERS

The ADRV9004 offers two distinct PLL paths, an RF PLL for the high frequency RF path and a baseband PLL for the digital and sampling clocks of the data converters.

RF PLL

The PLL structure in the ADRV9004 is unique in the sense that instead of having one dedicated PLL for the receive data path and a dedicated PLL for the transmit data path, two RF PLLs are in the device and both PLLs can source the receiver, the transmitter, both paths, or neither. This flexibility enables the ADRV9004 to meet various applications that require versatility.

The RF PLL supports the use of both internal and external LO signals. The internal LO is generated by an on-chip VCO, which is tunable over a frequency range of 6.5 GHz to 13 GHz. The output of the VCO is phase-locked to an external reference clock through a fractional-N PLL that is programmable through the API command. The VCO outputs are steered through a combination of frequency dividers to produce in-phase and quadrature phase LO signals in the 30 MHz to 6 GHz frequency range.

Alternatively, an external LO signal can be applied to the external LO inputs of the ADRV9004 to generate the LO signals in quadrature for the RF path. If the external LO path is chosen, the input frequency range is between 60 MHz and 12 GHz.

PLL synthesizers are fractional-N designs that incorporate completely integrated VCOs and loop filters. In TDD mode, LO distribution paths and receive and transmit data paths turn on and off as appropriate for the receive and transmit frames. In FDD mode, the transmit PLL and the receive PLL can be activated simultaneously. These PLLs require no external components. The RF LO generation circuits offer a trade-off between performance and power consumption.

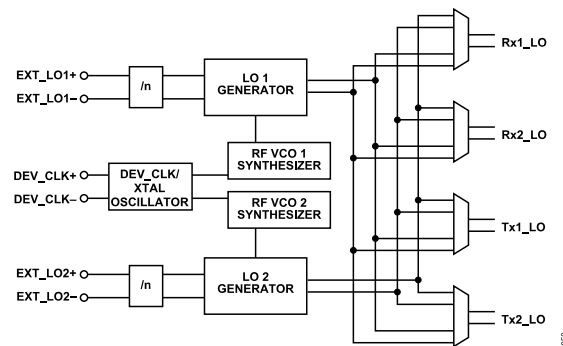

Figure 362. RF LO

The ADRV9004 supports various forms of fast frequency hopping (FFH) with the frequency dwell time and transition time as the main distinguishing factors between these forms. The RF PLL phase noise and the QEC and LOL algorithm performance degrade as a function of decreasing frequency transition times. FFH mode supports hop frequencies that are preloaded at power-up or streamed by the user onto the ADRV9004. Hopping between the frequencies in FFH mode can be triggered by toggling a GPIO pin or executing an API command.

Baseband PLL

The ADRV9004 contains a baseband PLL synthesizer that generates all baseband and data port related clocks. Two options are provided for a high performance baseband PLL and a low power baseband PLL. A high performance baseband PLL offers greater flexibility in generating clocks to support a wider range of sample rates. A low power baseband PLL has a limitation in supporting certain sample rates but consumes less power. Both high performance and low power baseband PLLs are automatically programmed based on the data rate and sample rate requirements of the system.

SPI

The ADRV9004 uses an SPI to communicate with the baseband processor. This interface can be configured either as a 4-wire interface with dedicated receive and transmit ports, or as a 3-wire interface with a bidirectional data communications port. This bus

THEORY OF OPERATION

allows the baseband processor to set all device control parameters using a simple address data serial bus protocol.

Write commands follow a 24-bit format. The first bit sets the bus direction of the bus transfer. The next 15 bits set the address where the data is written. The final eight bits contain the data transferred to the specific register address. Read commands follow a similar format with the exception that the first 16 bits are transferred on the SPI_DIO pin and the final eight bits are read from the ADRV9004 either on the SPI_DO pin in 4-wire mode or on the SPI_DIO pin in 3-wire mode.

GPIO PINS

Digital General-Purpose Inputs/Outputs (DGPIOs)

The ADRV9004 GPIO signals referenced to the VDIGIO_1P8 supply are intended to interface with digital circuitry and can be configured for numerous functions. Some of these pins, when configured as outputs, are used by the baseband processor as real-time signals to provide a number of internal settings and measurements. This configuration allows the baseband processor to monitor receiver performance in different situations. Signals used for manual gain mode, calibration flags, state machine states, and various receiver parameters are among the outputs that can be monitored on these pins. In addition, certain pins can be configured as inputs and used in various functions, such as setting the receiver gain or transmitter attenuation in real time.

Analog General-Purpose Inputs/Outputs (AGPIOs)

The AGPIO pins are intended to interface with system blocks that perform analog functions. The AGPIO pins referenced to the VAGPIO_1P8 supply provide control signals to the external components, such as the low noise amplifier (LNA) or digital step

attenuator (DSA). The selected AGPIO pins provide an alternate auxiliary DAC functionality. See [Table 18](#) for more details on pin mapping.

AUXILIARY CONVERTERS

Auxiliary ADC Inputs (AUXADC_x)

The ADRV9004 contains four auxiliary ADCs with the corresponding inputs connected to four dedicated input pins (AUXADC_x). This block can monitor system voltages without additional components. The auxiliary ADC is 10 bits with an input voltage range of 0.05 V to 0.95 V. When enabled, the auxiliary ADC is free running. An API function allows the user to read back the last value latched by the ADC.

Auxiliary DACs Outputs (AUXDAC_x)

The ADRV9004 contains four identical auxiliary DACs (AUXDAC_x) that can supply bias voltages, analog control voltages, or other system functionality. The auxiliary DACs (AUXDAC_0 to AUXDAC_3) are multiplexed with the AGPIO_xx pins, as shown in [Table 18](#). The auxiliary DACs are 12 bits and have an output voltage range of approximately 0.05 V to VDDA_1P8 – 0.05 V and have a current drive of 10 mA. The auxiliary DACs generate ramp up and ramp down patterns that can be loaded into the ADRV9004 and then triggered based on state of dedicated DGPIO pin.

JTAG BOUNDARY SCAN

The ADRV9004 provides support for a JTAG boundary scan. There are five dual function pins associated with the JTAG interface. These pins, as shown in [Table 19](#), are used to access the on-chip test access port. To enable the JTAG functionality, set the DGPIO_8 pin through DGPIO_11 pin and the MODE pin, as shown in [Table 19](#).

Table 18. Pin Number to AGPIO_xx Mapping and AUXDAC_x

Pin Number	Primary Function	Alternate Function
E12	AGPIO_0	AUXDAC_0
F10	AGPIO_1	AUXDAC_1
E3	AGPIO_2	AUXDAC_2
F5	AGPIO_3	AUXDAC_3
F4	AGPIO_4	Not applicable
G4	AGPIO_5	Not applicable
G6	AGPIO_6	Not applicable
H6	AGPIO_7	Not applicable
G9	AGPIO_8	Not applicable
H9	AGPIO_9	Not applicable
F11	AGPIO_10	Not applicable
G11	AGPIO_11	Not applicable

THEORY OF OPERATION

Table 19. Pin Number to DGPIO_xx Mapping and JTAG Function

Pin Number	Primary Function	JTAG Function, Boundary Scan CMOS Mode	JTAG Function, Boundary Scan LVDS Mode
K6	DGPIO_0	Not applicable	Not applicable
K7	DGPIO_1	Not applicable	Not applicable
K8	DGPIO_2	Not applicable	Not applicable
K9	DGPIO_3	TDO	TDO
K10	DGPIO_4	$\overline{\text{TRST}}$	$\overline{\text{TRST}}$
K11	DGPIO_5	TDI	TDI
L4	DGPIO_6	TMS	TMS
L5	DGPIO_7	TCLK	TCLK
L6	DGPIO_8	User sets to 0	User sets to 1
L9	DGPIO_9	User sets to 0	User sets to 0
L10	DGPIO_10	User sets to 0	User sets to 0
L11	DGPIO_11	User sets to 0	User sets to 0
M9	DGPIO_12/TX1_DCLK_OUT-	Not applicable	Not applicable
M10	DGPIO_13/TX1_DCLK_OUT+	Not applicable	Not applicable
M6	DGPIO_14/TX2_DCLK_OUT-	Not applicable	Not applicable
M5	DGPIO_15/TX2_DCLK_OUT+	Not applicable	Not applicable
L13	MODE Pin	User sets to 1	User sets to 1

APPLICATIONS INFORMATION

POWER SUPPLY SEQUENCE

The ADRV9004 requires a specific power-up sequence to avoid undesired power-up currents. The optimal power-on sequence requires VDD_1P0 to power up first. The VDDA_1P3 and VDDA_1P8 supplies must then power up after the VDD_1P0 supply. If VDDA_1P0 is used, VDDA_1P0 must be powered up after VDDA_1P3 and VDDA_1P8 are enabled.

The user must toggle the $\overline{\text{RESET}}$ signal after power has stabilized prior to configuration.

DIGITAL DATA INTERFACE

The ADRV9004 data interface supports both CMOS and LVDS electrical interfaces. The CSSI is intended for narrow RF signal bandwidths, and the LVDS synchronous serial interface (LSSI) can support the full RF bandwidth of the ADRV9004. [Table 20](#) provides a high level overview. For more details, refer to the [ADRV9001](#) system development user guide.

All signal lanes support both electrical interfaces, but concurrent operation of both interfaces is not supported. Additionally, each receive and transmit channel has a dedicated set of lanes for transferring information. The receive and transmit channels cannot be reconfigured to an alternative ball configuration that is different from how it has been assigned by design.

CSSI

The CSSI supports two modes of operation, 1-lane serialized data or 4-lane data. In either case, the maximum clock frequency supported by the CMOS configuration is 80 MHz.

For the CSSI in 1-lane data mode, 16 bits of I data and 16 bits of Q data (a total of 32 data bits) are serialized on a single lane. [Figure 363](#) shows a graphical overview of the CSSI in 1-lane data mode.

For the CSSI in 4-lane data mode, the I and Q digital data is spread across four data lanes. The 16 bits of I data and 16 bits of Q data are split into 8 bits and sent over one of four data lanes. For example, Lane 0 would have 8 LSB bits of I data, Lane 1 would have 8 MSB bits of I data, Lane 2 would have 8 LSB bits of Q data, and Lane 3 would have 8 MSB bits of Q data.

The CSSI in 4-lane data mode supports both a full rate clock and a double data rate (DDR) clock. The DDR clock mode allows data to be latched on both the rising and falling edges, which enables twice the available RF bandwidth, as shown in [Figure 364](#).

CSSI Receive

In the receive CMOS configuration, two additional signal lanes are required for the strobe and clock signals in addition to the data

lane requirement as described for the CSSI in 1-lane mode and the CSSI in 4-lane mode, which allows a total of three signal lanes for the CSSI in 1-lane data mode and six total signal lanes for the CSSI in 4-lane data mode.

RXx_DCLK_OUT is an output clock signal that synchronizes the data and strobe output signals. RXx_STROBE_OUT is a strobe output signal that indicates the first bit of the serial data stream. The RXx_STROBE_OUT signal can be configured to indicate the start of the I and Q samples. For a 16-bit data sample, the RXx_STROBE_OUT signal is high for one clock cycle and low for 31 clock cycles. Alternatively, the RXx_STROBE_OUT signal can be configured to be high for I data duration and low for Q data duration. In this case, for a 16-bit data sample, the RXx_STROBE_OUT signal is high for 16 clock cycles (I data) and low for 16 clock cycles (Q data).

CSSI Transmit

For the transmit CMOS configuration, three additional signal lanes are required for the strobe, clock input, and clock output in addition to the data lane requirement as described for the CSSI in 1-lane data mode and the CSSI in 4-lane data mode, which allows a total of four signal lanes for the CSSI in 1-lane data mode and seven total signal lanes for the CSSI in 4-lane data mode.

TXx_DCLK_IN is an input clock to the ADRV9004 that synchronizes to the data inputs (TXx_DATA_IN) and strobe inputs (TXx_STROBE_IN). TXx_STROBE_IN is an input signal that indicates the first bit of the serial data sample. Similar to the receive path, the transmit strobe has two configuration options. The TXx_DCLK_OUT is an output clock from the ADRV9004 to the external baseband device to generate the TXx_DCLK_IN, TXx_STROBE_IN, and TXx_DATA_IN signals.

LSSI

The LSSI supports the higher RF channel bandwidths and requires differential signal pairs. In LSSI mode, there are two data transfer formats, 1-lane data mode, where both the I and Q data are serialized on a single differential pair, or 2-lane data mode, where the I and Q data occupy separate differential pairs. The selection of either 1-lane data mode or 2-lane data mode depends on the RF channel bandwidth. To capture the maximum 40 MHz RF bandwidth of the ADRV9004, select the LSSI in 2-lane data mode. In either case, the maximum clock frequency supported by the LSSI configuration is 491.52 MHz and the clock type is DDR. Refer to [Figure 365](#) for more details.

APPLICATIONS INFORMATION

Table 20. ADRV9004 Data Port Interface Modes

Interface Mode	Data Lanes per Channel	Serialization Factor per Data Lane	Maximum Data Lane Rate (MHz)	Maximum Clock Rate (MHz)	Maximum RF Bandwidth (MHz)	Sample Rate for I and Q Data (MHz)	Data Type ¹	Figure Reference
CSSI in 1-Lane Data	1	32	80	80	1.25	2.5	Normal	Figure 363
CSSI in 1-Lane Data	1	32	160	80	2.5	5	DDR	
CSSI in 4-Lane Data	4	8	80	80	5	10	Normal	
CSSI in 4-Lane Data	4	8	160	80	10	20	DDR	Figure 364
LSSI in 1-Lane Data	1	32	983.04	491.52	20	30.72	DDR	
LSSI in 2-Lane Data	2	16	983.04	491.52	40	61.44	DDR	Figure 365
LSSI in 2-Lane Data	2	12	737.28	368.64	40	61.44	DDR	

¹ Normal data type refers to data on the rising edges, and DDR is double data rate, where data is available on the rising and falling edges of the input clock.

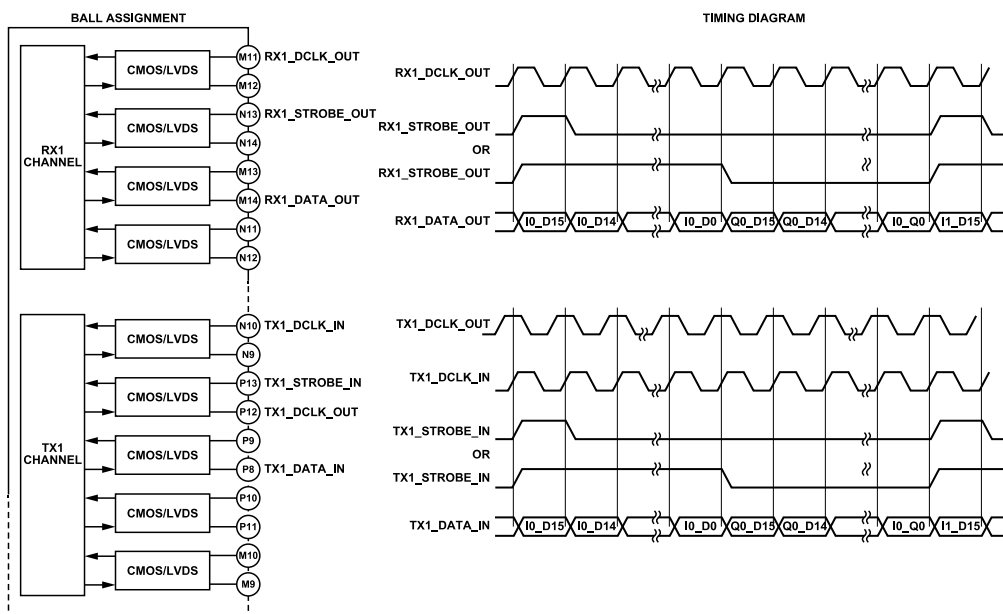

Figure 363. CSSI in 1-Lane Data Mode

APPLICATIONS INFORMATION

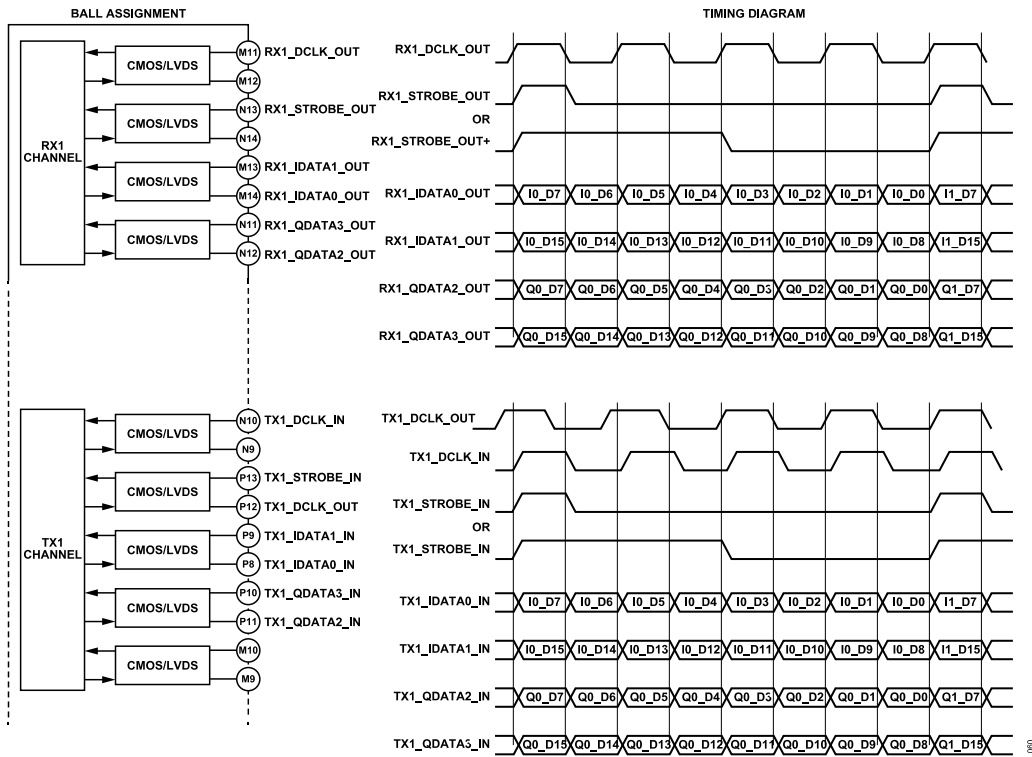

Figure 364. CSSI in 4-Lane Data Mode, DDR

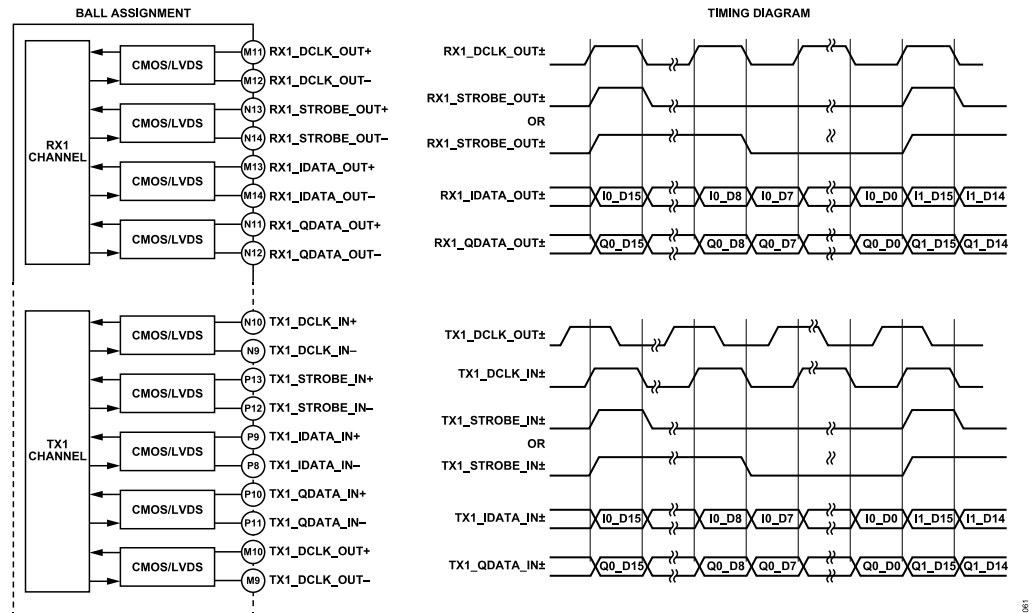

Figure 365. LSSI in 2-Lane Data Mode, DDR

OUTLINE DIMENSIONS

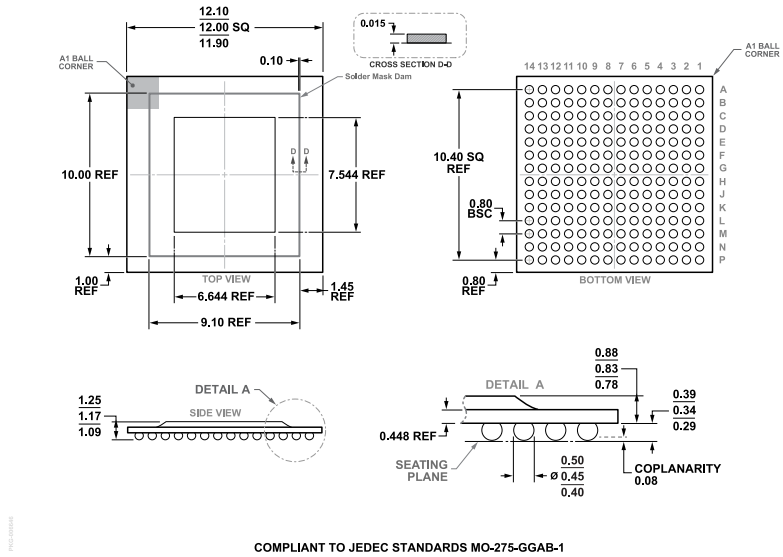

Figure 366. 196-Ball Chip Scale Package Ball Grid Array [CSP_BGA] (BC-196-16)
Dimensions shown in millimeters

Updated: January 28, 2022

ORDERING GUIDE

Model ¹	Temperature Range	Package Description	Packing Quantity	Package Option
ADRV9004BBCZ	-40°C to +85°C	CHIP SCALE BGA		BC-196-16
ADRV9004BBCZ-RL	-40°C to +85°C	CHIP SCALE BGA	Reel, 1500	BC-196-16

¹ Z = RoHS Compliant Part.