

# 10/100 Base-Tx Tap Down RJ45 with LED

ARJC02-111009D

RoHS/RoHS II Compliant

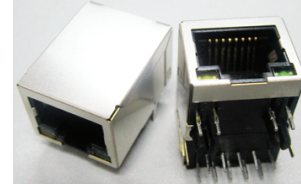

16.0 x 13.55 x 21.1mm

## FEATURES:

- Compliant with IEEE802.3 standard
- 350uH minimum OCL with 8mA bias current
- High performance for maximum EMI suppression
- High reliability – 750 mating/unmating cycles

## APPLICATIONS:

- Designed for most leading PHY IC manufacturers such as Broadcom, Marvell, Microsemi.
- Supports 10/100 Base-T applications
- Provides signal conditioning, EMI suppression and signal isolation.

## STANDARD SPECIFICATIONS

Operating temperature range: 0°C to +70°C Storage temperature range: -25°C to +85°C

Standard Electrical Specifications @25°C

Parameters	Minimum	Typical	Maximum	Units	Notes
Turn Ratio ( $\pm 3\%$ )	1CT:1CT				Tx and Rx
Inductance	350			uH	100kHz/0.1V@8mA
Insertion Loss			-1.0	dB	1-100MHz
Return Loss	-18			dB	1-10MHz
	-16				10-30MHz
	-14				30-60MHz
	-12				60-80MHz
	-10				80-100MHz
CMR	-35			dB	1-100MHz
Crosstalk	-35			dB	1-100MHz
Hipot	1500Vrms/1mA/1s				

## MECHANICAL DIMENSIONS

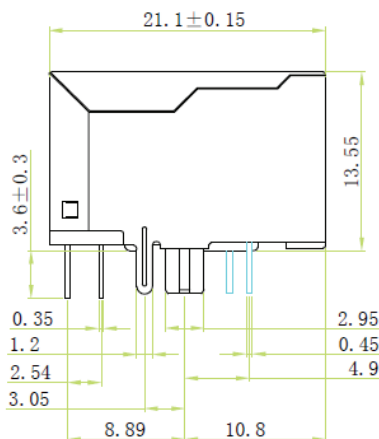
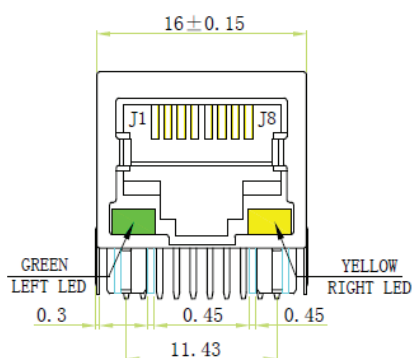

## Recommended Land Pattern

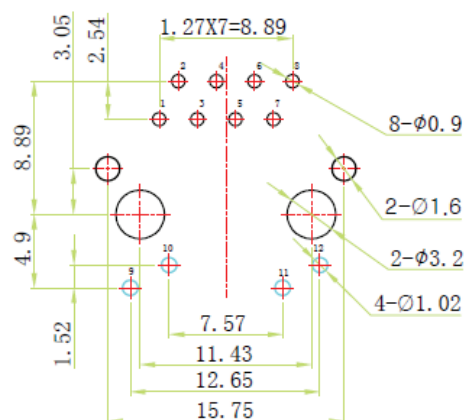

Dimensions: mm

\*\*Cosmetic differences may occur and do not affect the product's form, fit or function.

# 10/100 Base-Tx Tap Down RJ45 with LED

ARJC02-111009D

RoHS/RoHS II Compliant

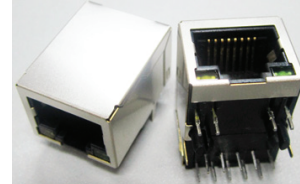

16.0 x 13.55 x 21.1mm

## SCHEMATICS

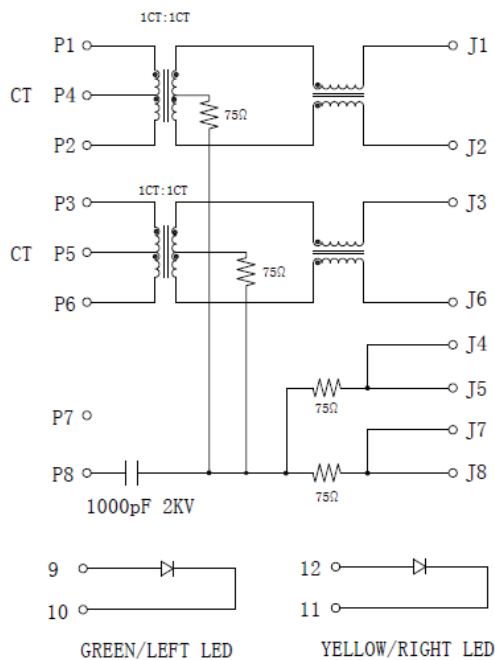

- ◆ CAPACITOR: 1000pF ± 25% 2KV.
- ◆ RESISTANCE: 75OHMS ± 20%.
- ◆ RESISTANCE OF COIL: 1.80HMS MAX, 0.250HMS MIN.

## PACKING:

Packing: (100pcs/tray)

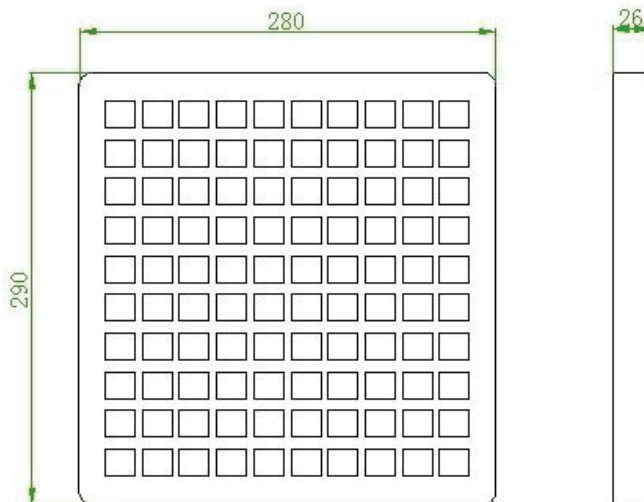

Dimensions: mm

**ATTENTION:** Abracon LLC's products are COTS – Commercial-Off-The-Shelf products; suitable for Commercial, Industrial and, where designated, Automotive Applications. Abracon's products are not specifically designed for Military, Aviation, Aerospace, Life-dependent Medical applications or any application requiring high reliability where component failure could result in loss of life and/or property. For applications requiring high reliability and/or presenting an extreme operating environment, written consent and authorization from Abracon LLC is required. Please contact Abracon LLC for more information.