

APPROVED: _____
 DATE: _____ TITLE: _____

Rev	AWO #	Description	Date	Appr
-		RELEASED	8/31/16	

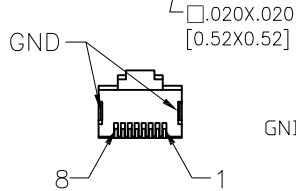

PIN ASSIGNMENT FRONT VIEW

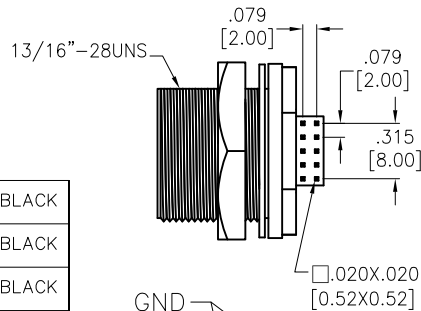
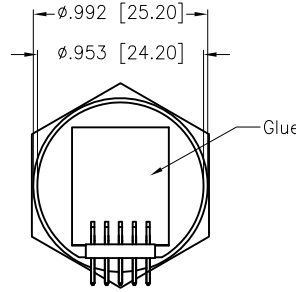
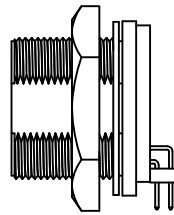
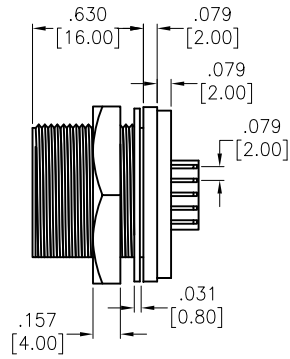
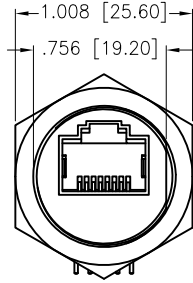
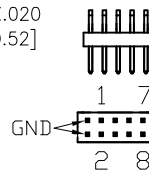

PIN ASSIGNMENT REAR VIEW

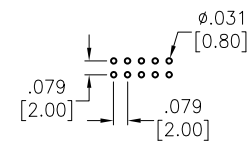

RECOMMENDED PCB LAYOUT

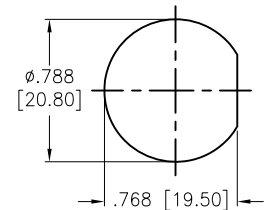

RECOMMENDED PANEL CUT

SD-RPC-JTPC-PRX0-000
 7=IP67

HEX NUT	NYLON+GF	BLACK
GASKET	EDPM	BLACK
CONNECTOR	R/A PIN HEADER, .079 [2.00] PITCH, 5P*2ROW	BLACK
PCB	FR4, DOUBLE SIDE, .039 [1.00] THICKNESS	
GROUND	GROUND CONTACT, SUS304	
CONTACT	RJ45 PIN, PHOS. BRONZE, 50u" GOLD	
CONNECTOR	RJ45 JACK, NYLON+GF	BLACK
PART NAME	DESCRIPTION	COLOR

Electrical:
 Voltage rating: 150 VAC max
 Current rating: 1 A
 Contact resistance: 30 mohms max
 Insulation resistance: 100 Mohms min
 Dielectric withstanding voltage:
 1,000 Vrms for 1 minute between Adjacent contacts
 1,500 Vrms for 1 minute between Shield contacts
 Temperature Rating:
 Operating temperature: -25°C to +85°C
 Environmental:
 Lead free, RoHS compliant.



UNLESS OTHERWISE SPECIFIED ALL DIMENSIONS ARE INCHES [MM] TOLERANCES: EXCEPT AS NOTED		
INCHES HOLES		
.X ± .10	Ø.X ± .10	
.XX ± .020	Ø.XX ± .015	
.XXX ± .015	Ø.XXX ± .010	
APPROVALS		DATE
DRAWN	HR	8/31/16
CHECKED	CK	8/31/16
APPROVED		

ADAM TECH		
909 Rahway Avenue, Union, NJ 07083 Phone: 908-687-5000 Fax: 908-687-5710		
TITLE WATERPROOF CONNECTOR, RJ45 SOCKET, C SIZE PLUG, SCREW TYPE, R/A PIN HEADER		
SIZE X	PART NO. SD-RPC-JTPC-PRX0-000	REV. -
REF: S00200T	SCALE: NTS	SHEET 1 OF 1