

MITSUBISHI <LINEAR ICs>
M5233L, P, FP

DUAL COMPARATOR

DESCRIPTION

The M5233 is a semiconductor circuit for a comparator designed to operate over a wide supply voltage range from 2 to 36V from a single power supply, with two circuits in each 8-pin SIP and 8-pin DIP and 8-pin mini flat package. A differential circuit which is equivalent to a conventional single power supply operational amplifier is used to enable operation from GND level to improve input characteristics. Power dissipation (circuit current) is low and output voltage is large. It fits to a general-purpose comparator for a variety of electronic equipment.

FEATURES

- Wide operating supply voltage range 2V~36V
 Dual power supplies: $\pm 1V \sim \pm 18V$
- Low circuit current 0.6mA (typ.)
- Wide common mode input voltage range
 $0V \sim V_{CC} - 1.5V$ (single power supply)
- Open collector output
- Output sink current 25mA
- Response time $1.3\mu\text{sec}$
- Pin compatible with general-purpose comparators 393, 2930

APPLICATION

Voltage comparator, window comparator, CR timer, time delay circuit, oscillator, etc.

RECOMMENDED OPERATING CONDITIONS

- Supply voltage range 2~36V
- Rated supply voltage 12V

PIN CONFIGURATION (TOP VIEW)

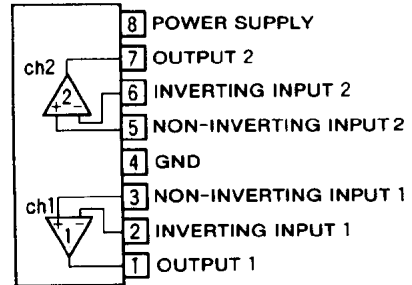

Outline 8P5 (L)

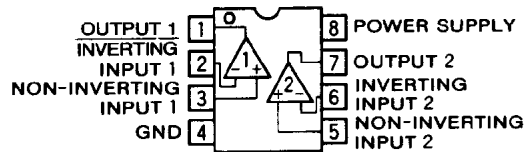

Outline 8P4 (P)

8P2S-A (FP)

EQUIVALENT CIRCUIT

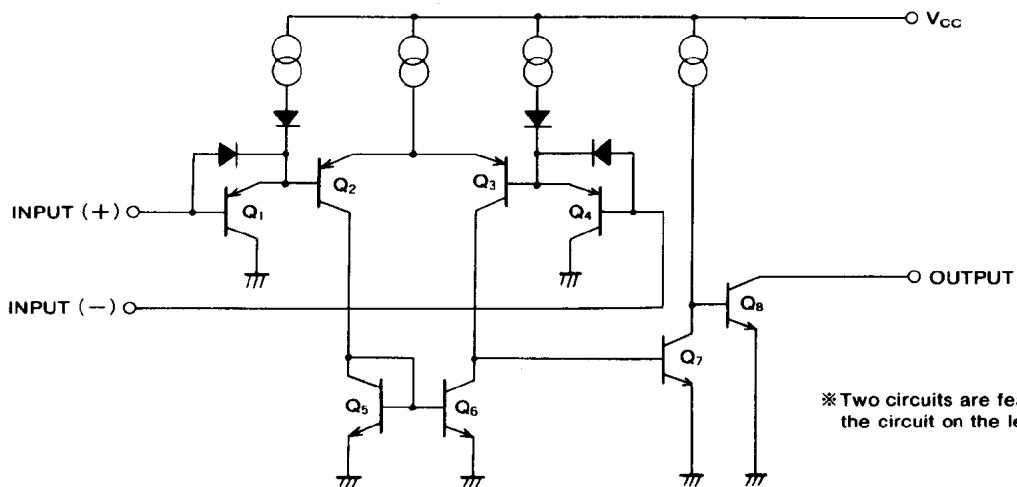

※ Two circuits are featured in the circuit on the left.

DUAL COMPARATOR

ABSOLUTE MAXIMUM RATINGS ($T_a=25^\circ\text{C}$, unless otherwise noted)

Symbol	Parameter	Ratings	Unit
V_{CC}	Supply voltage	36(± 18)	V
V_{ID}	Differential input voltage	36	V
V_{ICM}	Common mode input voltage range	-0.3~+36	V
P_d	Power dissipation	800(SIP)/625(DIP)/440(FP)	mW
T_{opr}	Operating temperature	-20~+75	$^\circ\text{C}$
T_{stg}	Storage temperature	-55~+125	$^\circ\text{C}$

ELECTRICAL CHARACTERISTICS ($T_a=25^\circ\text{C}$, $V_{CC}=5\text{V}$)

Symbol	Parameter	Test conditions	Limits			Unit
			Min	Typ	Max	
V_{IO}	Input offset voltage	$V_O=1.4\text{V}$, $V_{REF}=1.4\text{V}$, $R_S=0\Omega$		2	5	mV
I_{IO}	Input offset current			5	50	nA
I_B	Input bias current			25	250	nA
V_{ICM}	Common mode input voltage range		0		$V_{CC}-1.5$	V
G_V	Voltage gain	$R_L=15\text{k}\Omega$		200		V/mV
I_{CC}	Circuit current	$R_L=\infty$		0.6	1	mA
t_{PLH}	Response time	$R_L=5.1\text{k}\Omega$, $V_{RL}=5\text{V}$		1.3		μsec
I_{sink}	Output sink current	$V_{IN(-)}=1\text{V}$, $V_{IN(+)}=0\text{V}$, $V_O\leq 1.5\text{V}$	10	25		mA
V_{OL}	Output saturation voltage	$V_{IN(-)}=1\text{V}$, $V_{IN(+)}=0\text{V}$, $I_{sink}=8\text{mA}$		200	400	mV
I_{LO}	Output leak current	$V_{IN(+)}=1\text{V}$, $V_{IN(-)}=0\text{V}$, $V_O=5\text{V}$		0.1		nA

TYPICAL CHARACTERISTICS

THERMAL DERATING (MAXIMUM RATING)

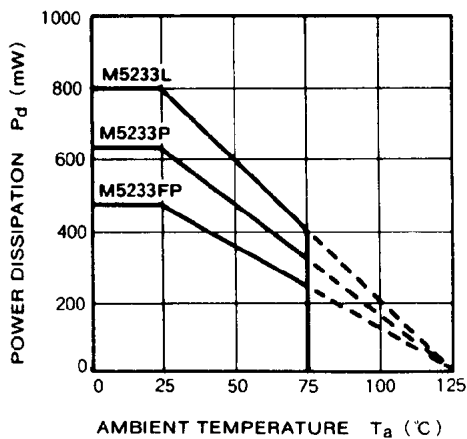

CIRCUIT CURRENT VS. SUPPLY VOLTAGE

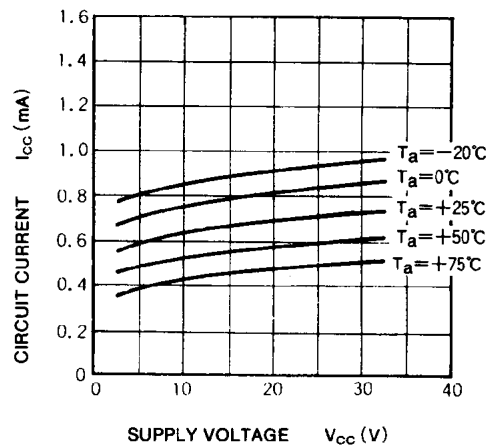

INPUT BIAS CURRENT VS. SUPPLY VOLTAGE

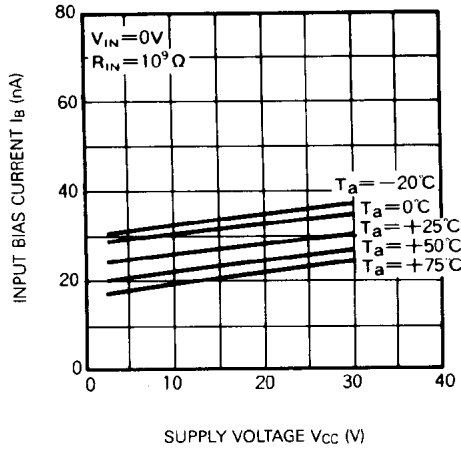

OUTPUT SATURATION VOLTAGE VS. OUTPUT SINK CURRENT

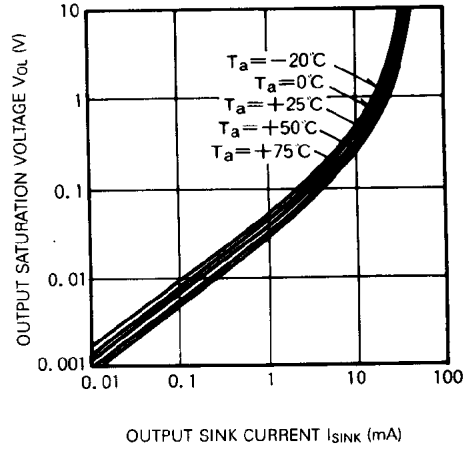

RESPONSE TIME FOR VARIOUS INPUT OVERDRIVES VS. NEGATIVE TRANSITION

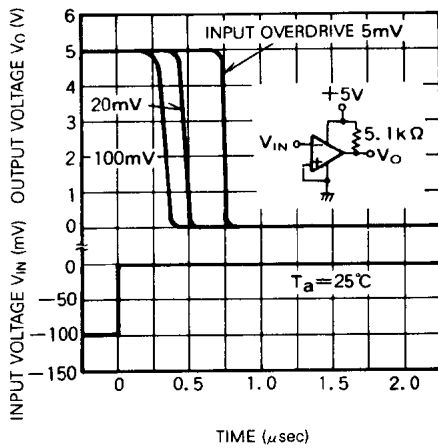

RESPONSE TIME FOR VARIOUS INPUT OVERDRIVES VS. NEGATIVE TRANSITION

