

Comparator Series

Automotive Excellent EMI Immunity Ground Sense Comparators

BA82903Yxxx-C BA82901Yxx-C

General Description

BA82903Yxxx-C and BA82901Yxx-C are high-gain, ground sense input comparator. These ICs are monolithic ICs integrated dual or quad independent comparators on a single chip. These comparators have some features of low power consumption, and can operate from 2 V to 36 V (single power supply). BA82903Yxxx-C, BA82901Yxx-C are manufactured for automotive requirements of engine control unit, electric power steering, anti-lock braking system, and so on. Furthermore, they have the advantage of EMI tolerance dose. It is easy to replace with conventional products, and the EMI design is simple.

Features

- AEC-Q100 Qualified^(Note 1)
 - Single or Dual Supply Operation
 - Wide Operating Supply Voltage Range
 - Standard Comparator Pin-assignments
 - Operable from Almost GND Level for Input
 - Internal ESD Protection Circuit
 - Wide Operating Temperature Range
 - Integrated EMI Filter
- (Note 1) Grade 1

Applications

- Engine Control Unit
- Electric Power Steering (EPS)
- Anti-Lock Braking System (ABS)
- Automotive Electronics

Selection Guide

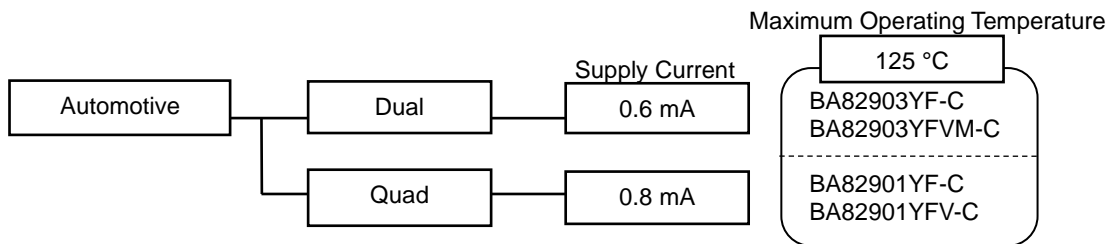

Key Specifications

- Operating Supply Voltage Range
Single Supply: 2.0 V to 36.0 V
Dual Supply: ±1.0 V to ±18.0 V
- Supply Current
BA82903Yxxx-C 0.6 mA (Typ)
BA82901Yxx-C 0.8 mA (Typ)
- Input Bias Current: 50 nA (Typ)
- Input Offset Current: 5 nA (Typ)
- Operating Temperature Range: -40 °C to +125 °C

Special Characteristics

- Input Offset Voltage
-40 °C to +125 °C: 9 mV (Max)

Packages

Packages	W(Typ) x D(Typ) x H(Max)
SOP8	5.00 mm x 6.20 mm x 1.71 mm
SOP14	8.70 mm x 6.20 mm x 1.71 mm
SSOP-B14	5.00 mm x 6.40 mm x 1.35 mm
MSOP8	2.90 mm x 4.00 mm x 0.90 mm

○Product structure : Silicon monolithic integrated circuit ○This product has no designed protection against radioactive rays

Pin Configurations

BA82903YF-C: SOP8
 BA82903YFVM-C: MSOP8

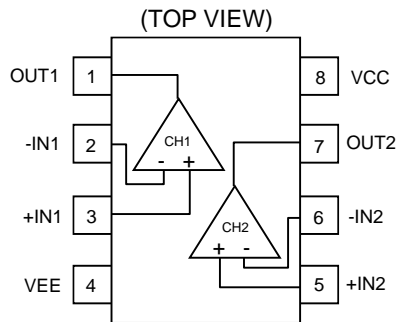

Pin No.	Pin Name
1	OUT1
2	-IN1
3	+IN1
4	VEE
5	+IN2
6	-IN2
7	OUT2
8	VCC

BA82901YF-C: SOP14
 BA82901YFV-C: SSOP-B14

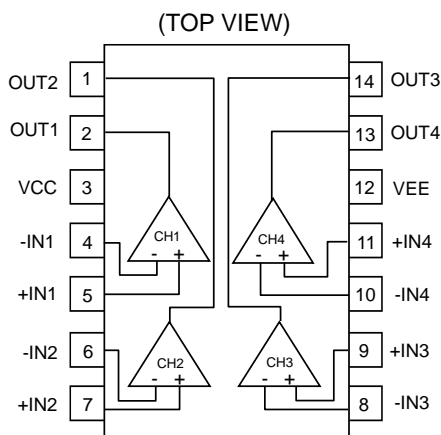

Pin No.	Pin Name
1	OUT2
2	OUT1
3	VCC
4	-IN1
5	+IN1
6	-IN2
7	+IN2
8	-IN3
9	+IN3
10	-IN4
11	+IN4
12	VEE
13	OUT4
14	OUT3

Absolute Maximum Ratings (Ta = 25 °C)

Parameter	Symbol	Rating	Unit
Supply Voltage	V _{CC} -V _{EE}	36	V
Differential Input Voltage ^(Note 1)	V _{ID}	36	V
Input Common-mode Voltage Range	V _{ICM}	(V _{EE} -0.3) to (V _{EE} +36)	V
Input Current	I _I	-10	mA
Storage Temperature Range	T _{stg}	-55 to +150	°C
Maximum Junction Temperature	T _{jmax}	150	°C

Caution 1: Operating the IC over the absolute maximum ratings may damage the IC. The damage can either be a short circuit between pins or an open circuit between pins and the internal circuitry. Therefore, it is important to consider circuit protection measures, such as adding a fuse, in case the IC is operated over the absolute maximum ratings.

Caution 2: Should by any chance the maximum junction temperature rating be exceeded the rise in temperature of the chip may result in deterioration of the properties of the chip. In case of exceeding this absolute maximum rating, design a PCB with thermal resistance taken into consideration by increasing board size and copper area so as not to exceed the maximum junction temperature rating.

(Note 1) The voltage difference between inverting input and non-inverting input is the differential input voltage. Then the input pin voltage is set to V_{EE} or more.

Thermal Resistance^(Note 1)

Parameter	Symbol	Thermal Resistance (Typ)		Unit
		1s ^(Note 3)	2s2p ^(Note 4)	
MSOP8				
Junction to Ambient	θ_{JA}	284.1	135.4	°C/W
Junction to Top Characterization Parameter ^(Note 2)	Ψ_{JT}	21	11	°C/W
SOP8				
Junction to Ambient	θ_{JA}	197.4	109.8	°C/W
Junction to Top Characterization Parameter ^(Note 2)	Ψ_{JT}	21	19	°C/W
SOP14				
Junction to Ambient	θ_{JA}	166.5	108.1	°C/W
Junction to Top Characterization Parameter ^(Note 2)	Ψ_{JT}	26	22	°C/W
SSOP-B14				
Junction to Ambient	θ_{JA}	159.6	92.8	°C/W
Junction to Top Characterization Parameter ^(Note 2)	Ψ_{JT}	13	9	°C/W

(Note 1) Based on JESD51-2A(Still-Air).

(Note 2) The thermal characterization parameter to report the difference between junction temperature and the temperature at the top center of the outside surface of the component package.

(Note 3) Using a PCB board based on JESD51-3.

(Note 4) Using a PCB board based on JESD51-7.

Layer Number of Measurement Board	Material	Board Size
Single	FR-4	114.3 mm x 76.2 mm x 1.57 mmt

Top	
Copper Pattern	Thickness
Footprints and Traces	70 μm

Layer Number of Measurement Board	Material	Board Size
4 Layers	FR-4	114.3 mm x 76.2 mm x 1.6 mmt

Top		2 Internal Layers		Bottom	
Copper Pattern	Thickness	Copper Pattern	Thickness	Copper Pattern	Thickness
Footprints and Traces	70 μm	74.2 mm x 74.2 mm	35 μm	74.2 mm x 74.2 mm	70 μm

Recommended Operating Conditions

Parameter	Symbol	Min	Typ	Max	Unit
Operating Supply Voltage	Vopr	2 (±1)	-	36 (±18)	V
Operating Temperature	Topr	-40	-	+125	°C

Electrical Characteristics

○BA82903Yxxx-C (Unless otherwise specified $V_{CC}=5\text{ V}$, $V_{EE}=0\text{ V}$)

Parameter	Symbol	Temperature Range	Limits			Unit	Conditions
			Min	Typ	Max		
Input Offset Voltage ^(Note 1)	V_{IO}	25 °C	-	2	5	mV	$V_{OUT}=1.4\text{ V}$
		Full range	-	-	9		$V_{CC}=5\text{ V to }36\text{ V}$, $V_{OUT}=1.4\text{ V}$
Input Offset Current ^(Note 1)	I_{IO}	25 °C	-	5	40	nA	$V_{OUT}=1.4\text{ V}$
		Full range	-	-	50		
Input Bias Current ^(Note 1)	I_B	25 °C	-	50	250	nA	$V_{OUT}=1.4\text{ V}$
		Full range	-	-	275		
Input Common-mode Voltage Range	V_{ICM}	25 °C	0	-	$V_{CC}-1.5$	V	-
		Full range	0	-	$V_{CC}-2.0$		
Large Signal Voltage Gain	A_v	25 °C	88	100	-	dB	$V_{CC}=15\text{ V}$, $V_{OUT}=1.4\text{ V to }11.4\text{ V}$ $R_L=15\text{ k}\Omega$, $V_{RL}=15\text{ V}$
		Full range	74	-	-		
Supply Current	I_{CC}	25 °C	-	0.6	1	mA	OUT=open
		Full range	-	-	2.5		OUT=open, $V_{CC}=36\text{ V}$
Output Sink Current ^(Note 2)	I_{SINK}	25 °C	6	16	-	mA	$V_{+IN}=0\text{ V}$, $V_{-IN}=1\text{ V}$, $V_{OUT}=1.5\text{ V}$
Output Saturation Voltage (Low Level Output Voltage)	V_{OL}	25 °C	-	150	400	mV	$V_{+IN}=0\text{ V}$, $V_{-IN}=1\text{ V}$ $I_{SINK}=4\text{ mA}$
		Full range	-	-	700		
Output Leakage Current (High Level Output Current)	I_{LEAK}	25 °C	-	1	-	nA	$V_{+IN}=1\text{ V}$, $V_{-IN}=0\text{ V}$, $V_{OUT}=5\text{ V}$
		Full range	-	-	1	μA	$V_{+IN}=1\text{ V}$, $V_{-IN}=0\text{ V}$, $V_{OUT}=36\text{ V}$
Response Time	t_{RE}	25 °C	-	1.3	-	μs	$R_L=5.1\text{ k}\Omega$, $V_{RL}=5\text{ V}$ $V_{IN}=100\text{ mV}_{P-P}$, overdrive=5 mV
			-	0.4	-		$R_L=5.1\text{ k}\Omega$, $V_{RL}=5\text{ V}$, $V_{IN}=\text{TTL}$ Logic Swing, $V_{REF}=1.4\text{ V}$
Operable Frequency	fopr	25 °C	100	-	-	kHz	$R_L=2\text{ k}\Omega$, $V_{+IN}=1.5\text{ V}$, $V_{-IN}=5\text{ V}_{P-P}$ (Duty 50 % Rectangular Pulse)

(Note 1) Absolute value

(Note 2) Under high temperatures, it is important to consider the T_{Jmax} and Thermal Resistance when selecting the output current.

When the output pin is continuously shorted, the output current may reduce because of the internal temperature rise by heating.

○BA82901Yxx-C (Unless otherwise specified $V_{CC}=5\text{ V}$, $V_{EE}=0\text{ V}$)

Parameter	Symbol	Temperature Range	Limits			Unit	Conditions
			Min	Typ	Max		
Input Offset Voltage ^(Note 3)	V_{IO}	25 °C	-	2	5	mV	$V_{OUT}=1.4\text{ V}$
		Full range	-	-	9		$V_{CC}=5\text{ V to }36\text{ V}$, $V_{OUT}=1.4\text{ V}$
Input Offset Current ^(Note 3)	I_{IO}	25 °C	-	5	40	nA	$V_{OUT}=1.4\text{ V}$
		Full range	-	-	50		
Input Bias Current ^(Note 3)	I_B	25 °C	-	50	250	nA	$V_{OUT}=1.4\text{ V}$
		Full range	-	-	275		
Input Common-mode Voltage Range	V_{ICM}	25 °C	0	-	$V_{CC}-1.5$	V	-
		Full range	0	-	$V_{CC}-2.0$		
Large Signal Voltage Gain	A_v	25 °C	88	100	-	dB	$V_{CC}=15\text{ V}$, $V_{OUT}=1.4\text{ V to }11.4\text{ V}$ $R_L=15\text{ k}\Omega$, $V_{RL}=15\text{ V}$
		Full range	74	-	-		
Supply Current	I_{CC}	25 °C	-	0.8	2	mA	OUT=open
		Full range	-	-	2.5		OUT=open, $V_{CC}=36\text{ V}$
Output Sink Current ^(Note 4)	I_{SINK}	25 °C	6	16	-	mA	$V_{+IN}=0\text{ V}$, $V_{-IN}=1\text{ V}$, $V_{OUT}=1.5\text{ V}$
Output Saturation Voltage (Low Level Output Voltage)	V_{OL}	25 °C	-	150	400	mV	$V_{+IN}=0\text{ V}$, $V_{-IN}=1\text{ V}$, $I_{SINK}=4\text{ mA}$
		Full range	-	-	700		
Output Leakage Current (High Level Output Current)	I_{LEAK}	25 °C	-	1	-	nA	$V_{+IN}=1\text{ V}$, $V_{-IN}=0\text{ V}$, $V_{OUT}=5\text{ V}$
		Full range	-	-	1	μA	$V_{+IN}=1\text{ V}$, $V_{-IN}=0\text{ V}$, $V_{OUT}=36\text{ V}$
Response Time	t_{RE}	25 °C	-	1.3	-	μs	$R_L=5.1\text{ k}\Omega$, $V_{RL}=5\text{ V}$ $V_{IN}=100\text{ mV}_{P-P}$, overdrive=5 mV
			-	0.4	-		$R_L=5.1\text{ k}\Omega$, $V_{RL}=5\text{ V}$, $V_{IN}=\text{TTL}$ Logic Swing, $V_{REF}=1.4\text{ V}$
Operable Frequency	fopr	25 °C	100	-	-	kHz	$R_L=2\text{ k}\Omega$, $V_{+IN}=1.5\text{ V}$, $V_{-IN}=5\text{ V}_{P-P}$ (Duty 50 % Rectangular Pulse)

(Note 3) Absolute value

(Note 4) Under high temperatures, it is important to consider the T_{Jmax} and Thermal Resistance when selecting the output current.

When the output pin is continuously shorted, the output current may reduce because of the internal temperature rise by heating.

Description of Electrical Characteristics

Described below are descriptions of the relevant electrical terms used in this datasheet. Items and symbols used are also shown. Note that item name and symbol and their meaning may differ from those on another manufacturer's or general document.

1. Absolute Maximum Ratings

Absolute maximum rating items indicate the condition which must not be exceeded even momentarily. Applying of voltage in excess of absolute maximum rating or use at outside the temperature range which is provided in the absolute maximum ratings may cause deteriorating the characteristics of the IC or destroying it.

1.1 Supply Voltage ($V_{CC-V_{EE}}$)

Indicates the maximum voltage that can be applied between the positive power supply pin and negative power supply pin without deteriorating the characteristics of the IC or without destroying it.

1.2 Differential Input Voltage (V_{ID})

Indicates the maximum voltage that can be applied between non-inverting pin and inverting pin without deteriorating the characteristics of the IC or without destroying it.

1.3 Input Common-mode Voltage Range (V_{ICM})

Indicates the voltage range that can be applied to the non-inverting pin and inverting pin without deteriorating the characteristics of the IC or without destroying it. Input common-mode voltage range of the maximum ratings does not assure normal operation of IC. For normal operation, use the IC within the input common-mode voltage range of electrical characteristics.

1.4 Storage Temperature Range (T_{stg})

The storage temperature range denotes the range of temperatures the IC can be stored without causing excessive deteriorating the characteristics of the IC.

2. Electrical Characteristics

2.1 Input Offset Voltage (V_{IO})

Indicates the voltage difference between non-inverting pin and inverting pin. It can be translated as the input voltage difference required for setting the output voltage at 0 V.

2.2 Input Offset Current (I_{IO})

Indicates the difference of input bias current between the non-inverting and inverting pins.

2.3 Input Bias Current (I_B)

Indicates the current that flows into or out of the input pin. It is defined by the average of input bias currents at the non-inverting and inverting pins.

2.4 Input Common-mode Voltage Range (V_{ICM})

Indicates the input voltage range where IC normally operates.

2.5 Large Signal Voltage Gain (A_v)

Indicates the amplifying rate (gain) of output voltage regarding the voltage difference between non-inverting pin and inverting pin. It is normally the amplifying rate (gain) with reference to DC voltage.

$$A_v = (\text{Output Voltage}) / (\text{Differential Input Voltage})$$

2.6 Supply Current (I_{CC})

Indicates the current that flows within the IC under no-load conditions.

2.7 Output Sink Current (I_{SINK})

Indicates the current flowing into the IC under specified output conditions.

2.8 Output Saturation Voltage (Low Level Output Voltage) (V_{OL})

Indicates the lower limit of output voltage under specified load conditions.

2.9 Output Leakage Current (High Level Output Current) (I_{LEAK})

Indicates the current that flows into the IC under specified input and output conditions.

2.10 Response Time (t_{RE})

Indicates the time interval between the input step function and the instant when the output crosses 50 % of the amplitude.

2.11 Operable Frequency (f_{opr})

Indicates minimum frequency that IC moves under specified conditions.

Typical Performance Curves ($V_{EE}=0\text{ V}$)

○BA82903Yxxx-C

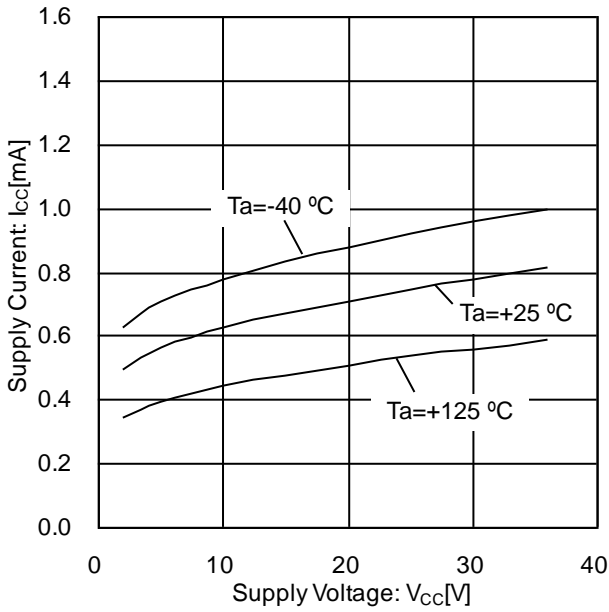

Figure 1. Supply Current vs Supply Voltage

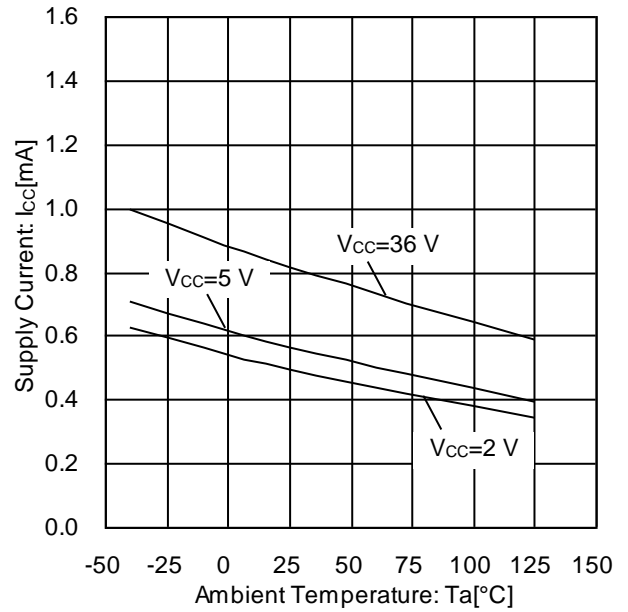

Figure 2. Supply Current vs Ambient Temperature

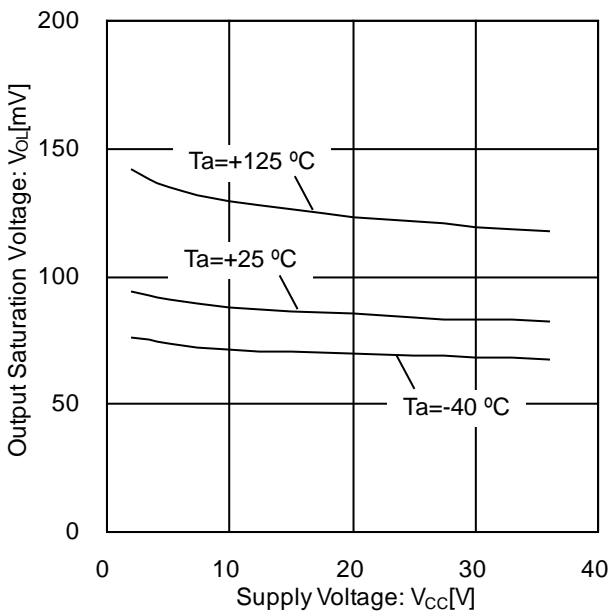

Figure 3. Output Saturation Voltage vs Supply Voltage
($I_{SINK}=4\text{ mA}$)

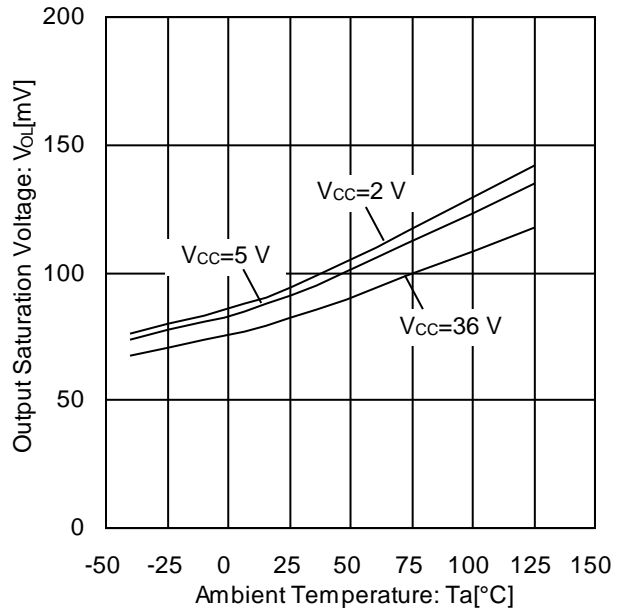

Figure 4. Output Saturation Voltage vs Ambient Temperature
($I_{SINK}=4\text{ mA}$)

(Note) The data above is measurement value of typical sample; it is not guaranteed.

Typical Performance Curves - continued

○BA82903Yxxx-C

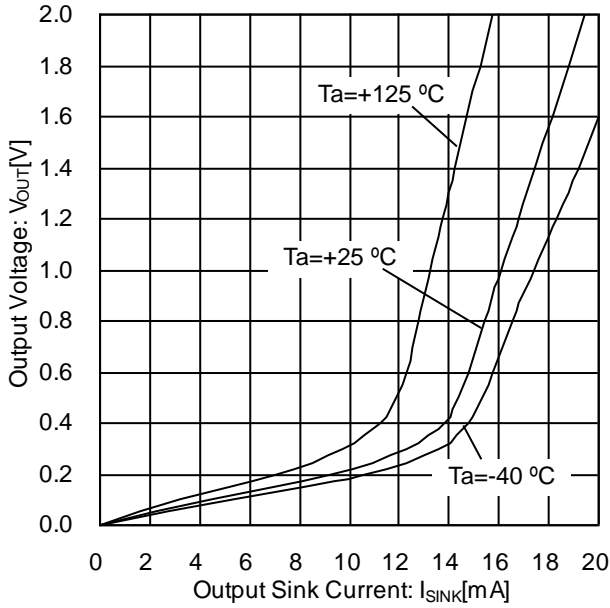

Figure 5. Output Voltage vs Output Sink Current (Vcc=5 V)

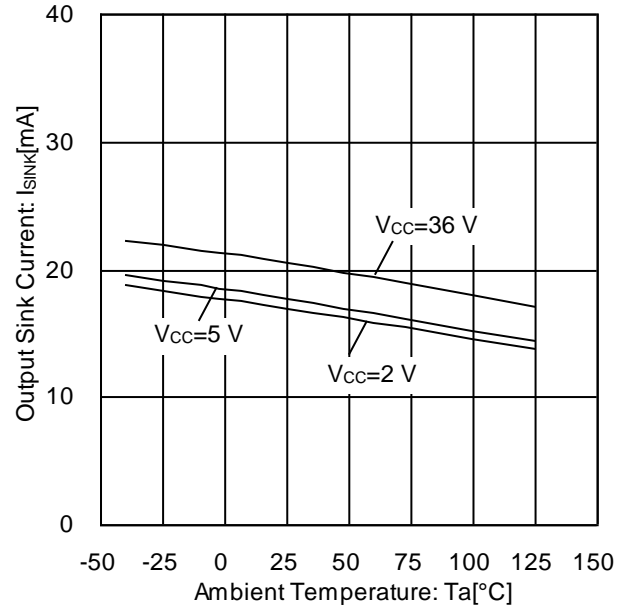

Figure 6. Output Sink Current vs Ambient Temperature (Vout=1.5 V)

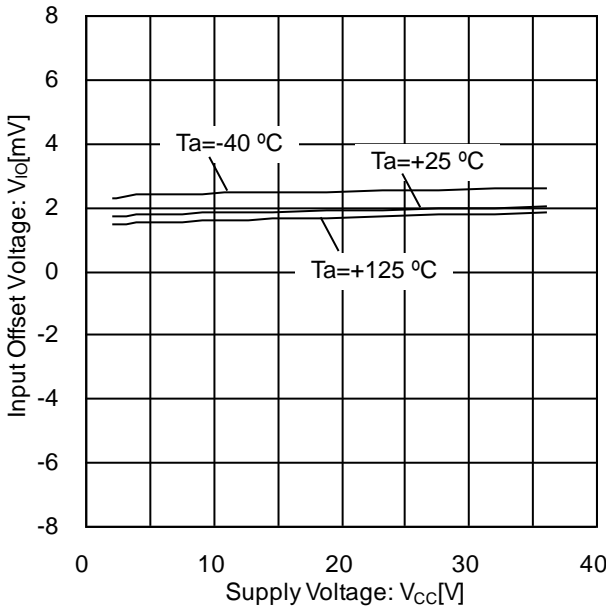

Figure 7. Input Offset Voltage vs Supply Voltage

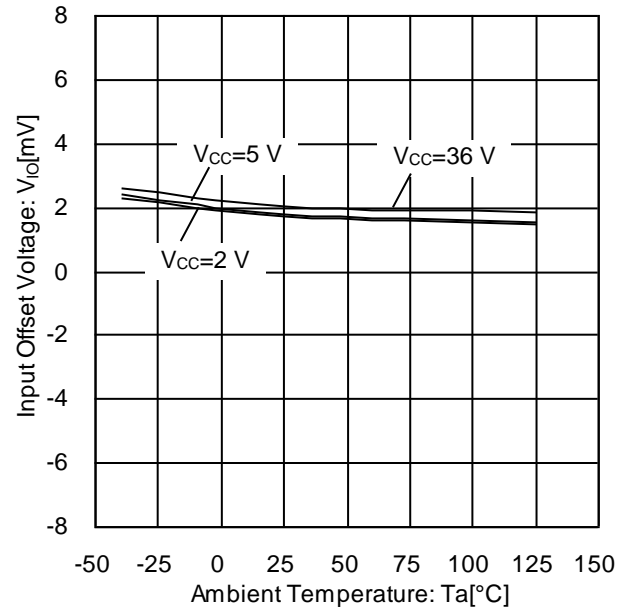

Figure 8. Input Offset Voltage vs Ambient Temperature

(Note) The data above is measurement value of typical sample; it is not guaranteed.

Typical Performance Curves - continued

○BA82903Yxxx-C

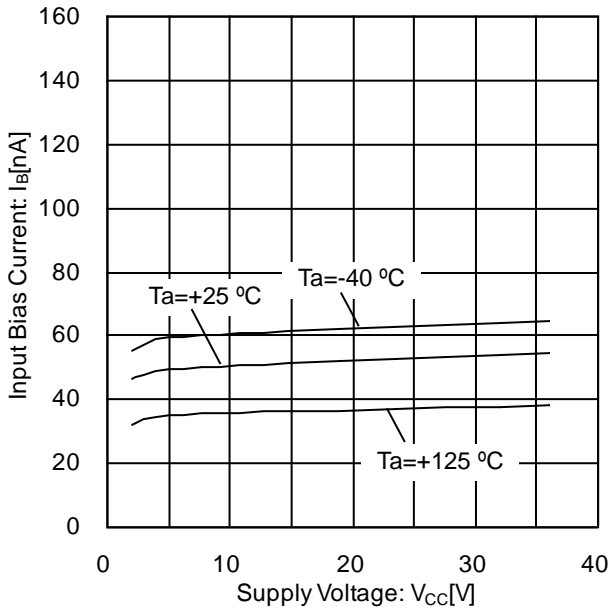

Figure 9. Input Bias Current vs Supply Voltage

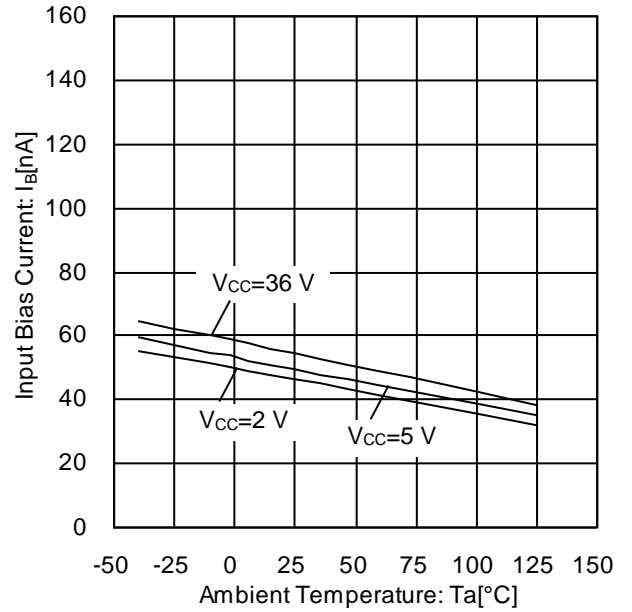

Figure 10. Input Bias Current vs Ambient Temperature

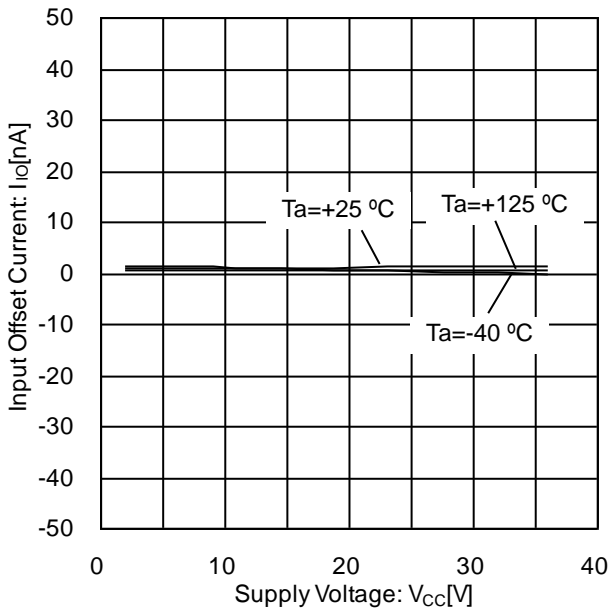

Figure 11. Input Offset Current vs Supply Voltage

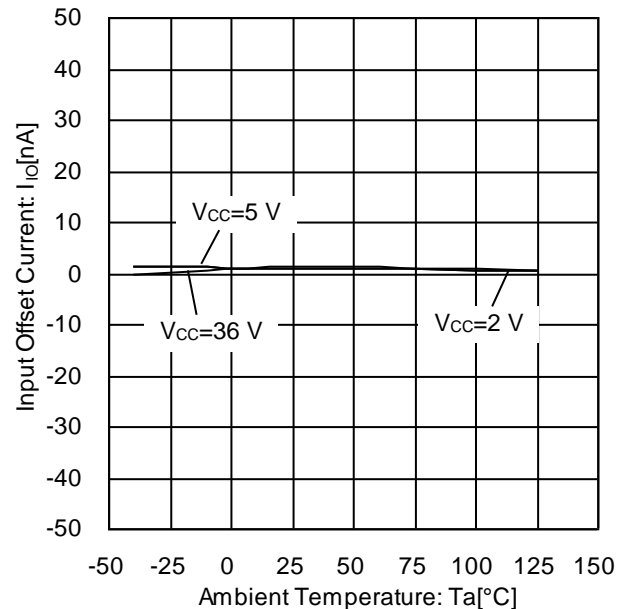

Figure 12. Input Offset Current vs Ambient Temperature

(Note) The data above is measurement value of typical sample; it is not guaranteed.

Typical Performance Curves - continued

○BA82903Yxxx-C

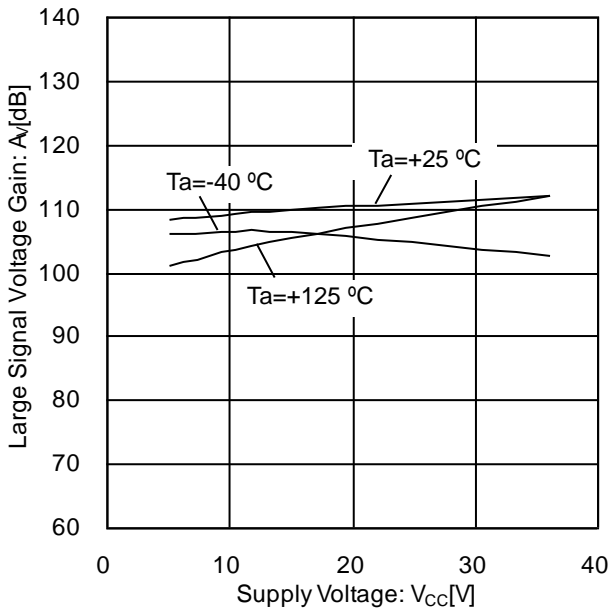

Figure 13. Large Signal Voltage Gain vs Supply Voltage

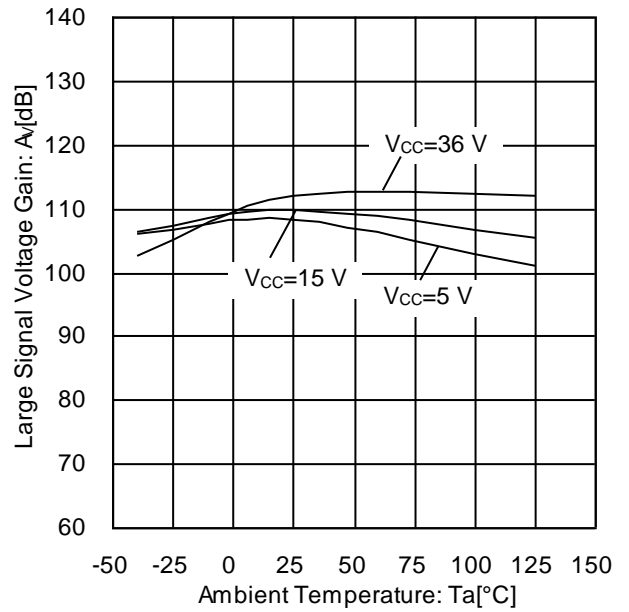

Figure 14. Large Signal Voltage Gain vs Ambient Temperature

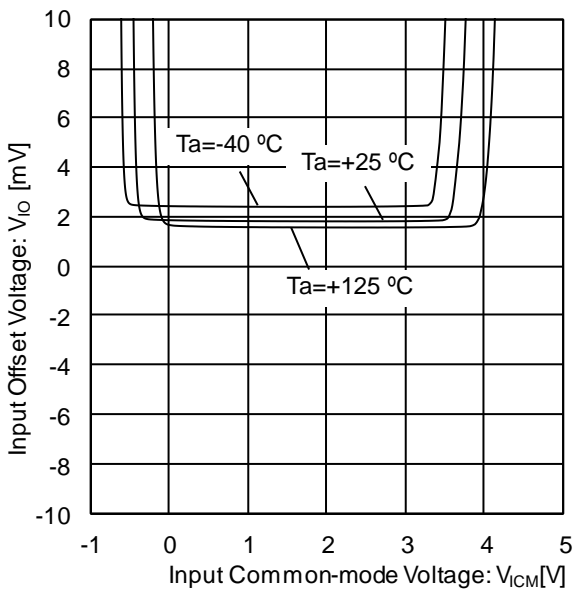

Figure 15. Input Offset Voltage vs Input Voltage (V_{CC}=5 V)

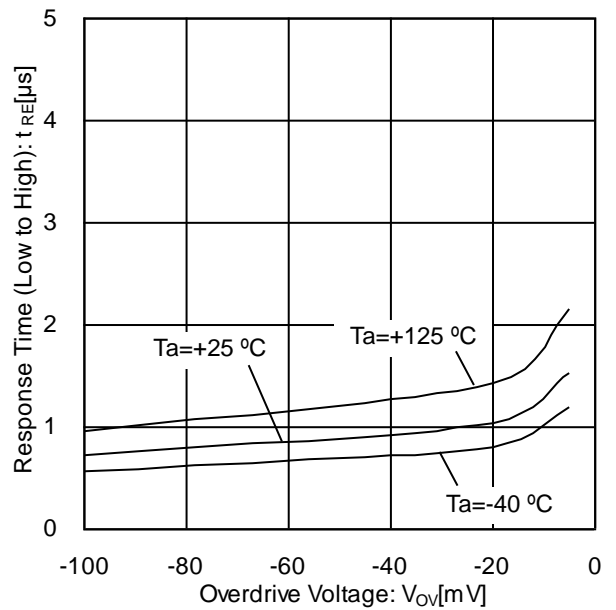

Figure 16. Response Time (Low to High) vs Overdrive Voltage (V_{CC}=5 V, V_{RL}=5 V, R_L=5.1 kΩ)

(Note) The data above is measurement value of typical sample; it is not guaranteed.

Typical Performance Curves - continued

○BA82903Yxxx-C

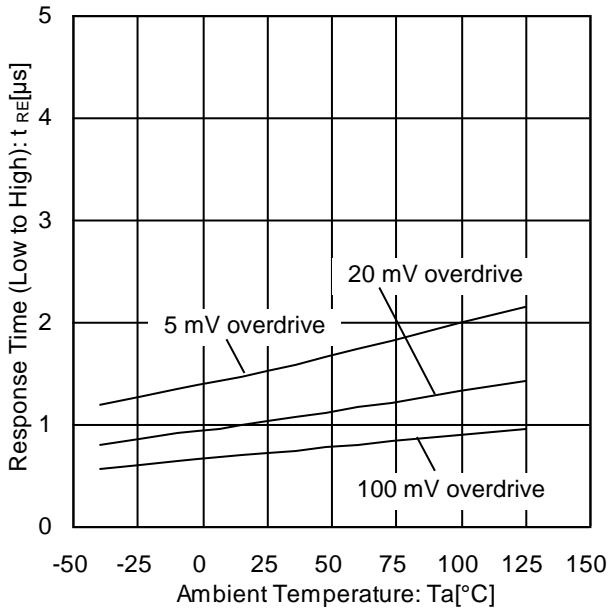

Figure 17. Response Time (Low to High) vs Ambient Temperature
(V_{CC}=5 V, V_{RL}=5 V, R_L=5.1 kΩ)

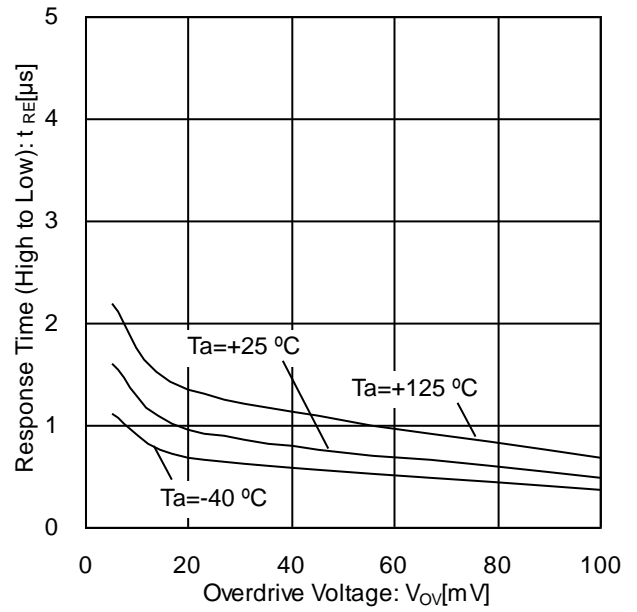

Figure 18. Response Time (High to Low) vs Overdrive Voltage
(V_{CC}=5 V, V_{RL}=5 V, R_L=5.1 kΩ)

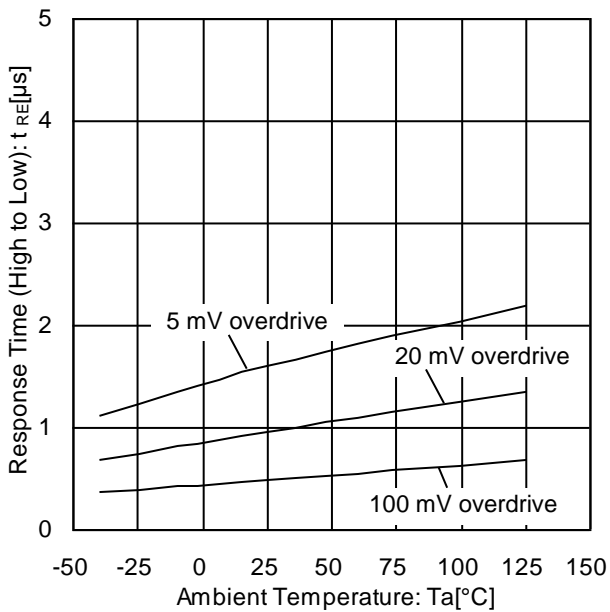

Figure 19. Response Time (High to Low) vs Ambient Temperature
(V_{CC}=5 V, V_{RL}=5 V, R_L=5.1 kΩ)

(Note) The data above is measurement value of typical sample; it is not guaranteed.

Typical Performance Curves - continued

○BA82901Yxx-C

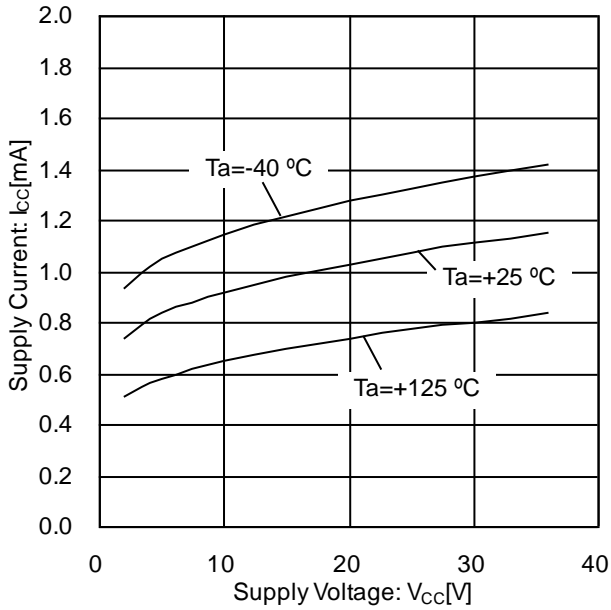

Figure 20. Supply Current vs Supply Voltage

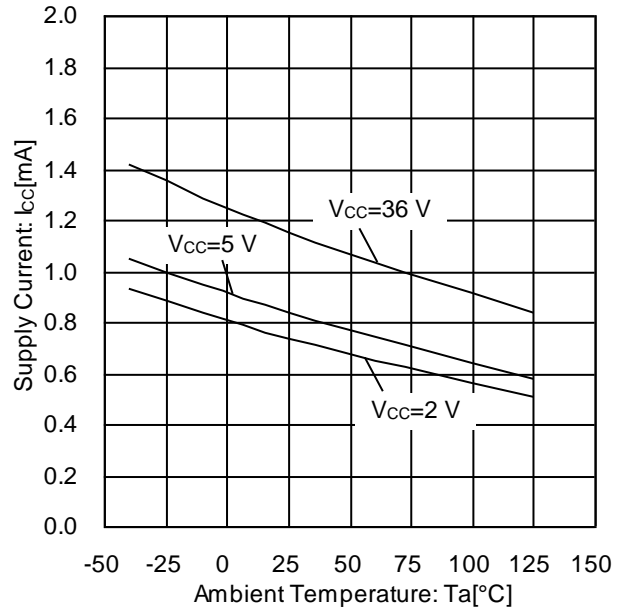

Figure 21. Supply Current vs Ambient Temperature

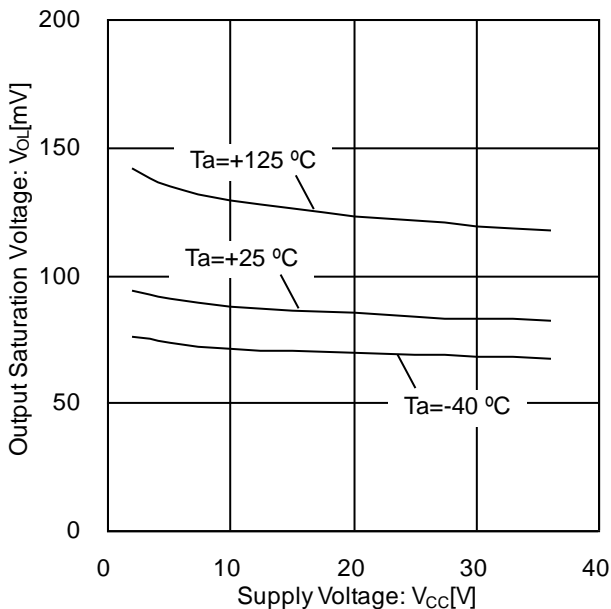

Figure 22. Output Saturation Voltage vs Supply Voltage
($I_{SINK}=4\text{ mA}$)

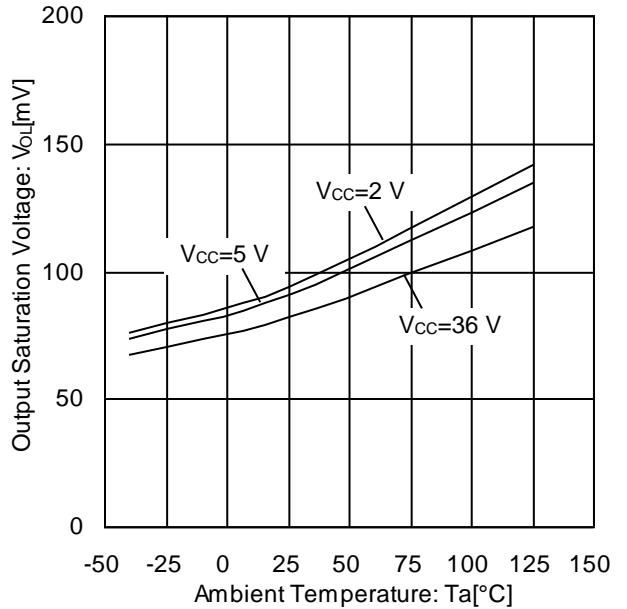

Figure 23. Output Saturation Voltage vs Ambient Temperature
($I_{SINK}=4\text{ mA}$)

(Note) The data above is measurement value of typical sample; it is not guaranteed.

Typical Performance Curves - continued

○BA82901Yxx-C

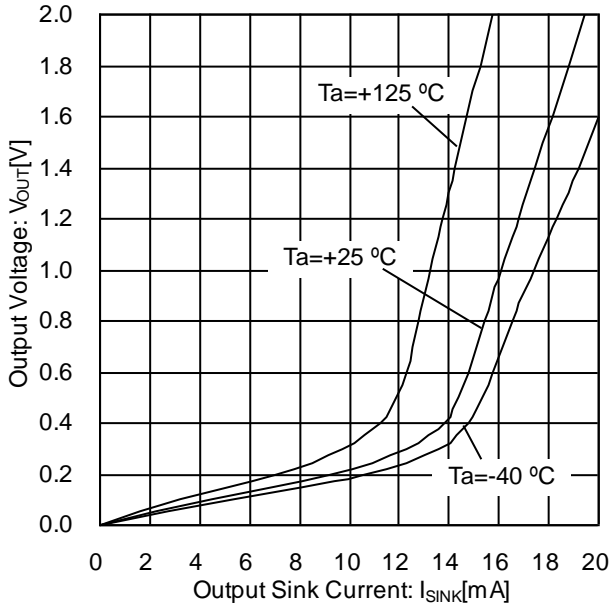

Figure 24. Output Voltage vs Output Sink Current (V_{CC}=5 V)

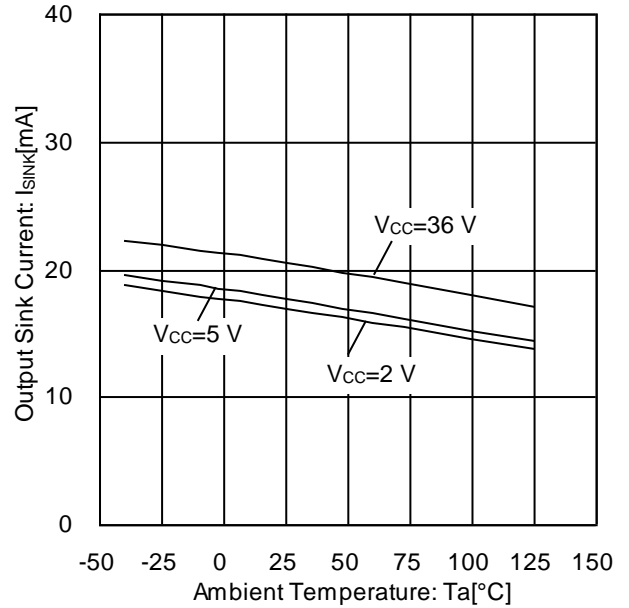

Figure 25. Output Sink Current vs Ambient Temperature (V_{OUT}=1.5 V)

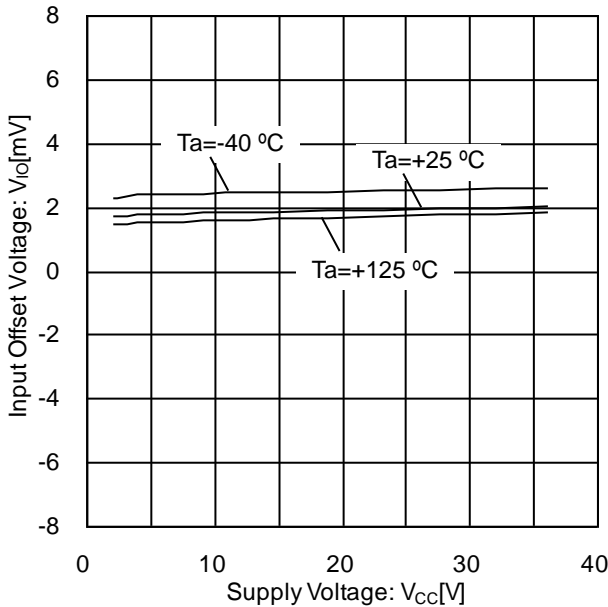

Figure 26. Input Offset Voltage vs Supply Voltage

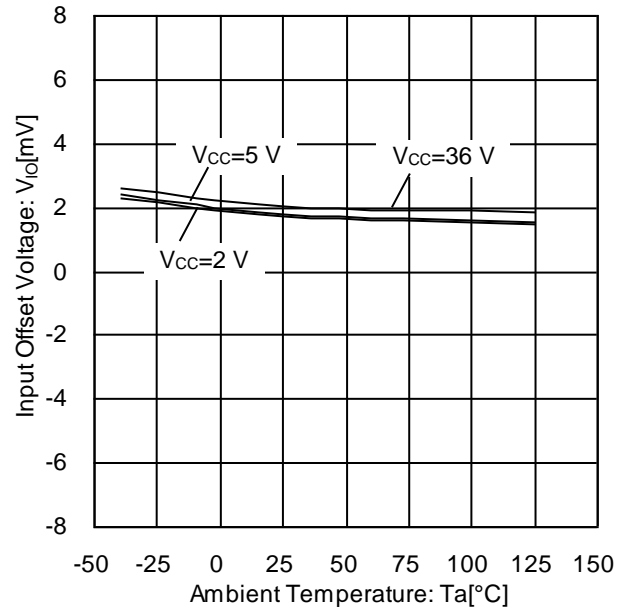

Figure 27. Input Offset Voltage vs Ambient Temperature

(Note) The data above is measurement value of typical sample; it is not guaranteed.

Typical Performance Curves - continued

○BA82901Yxx-C

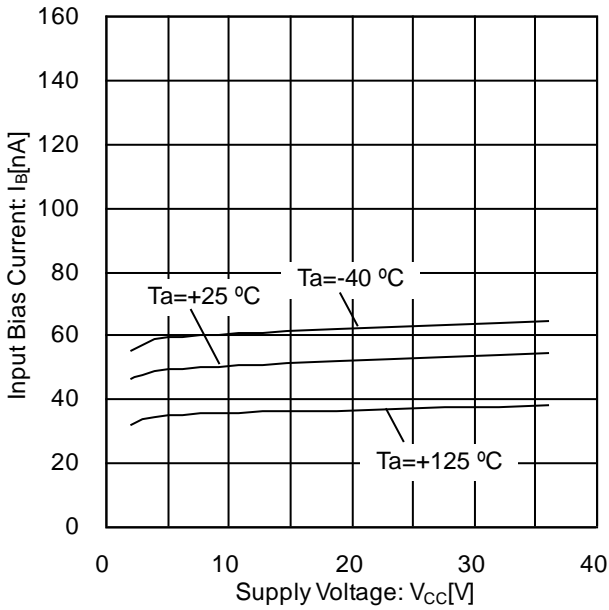

Figure 28. Input Bias Current vs Supply Voltage

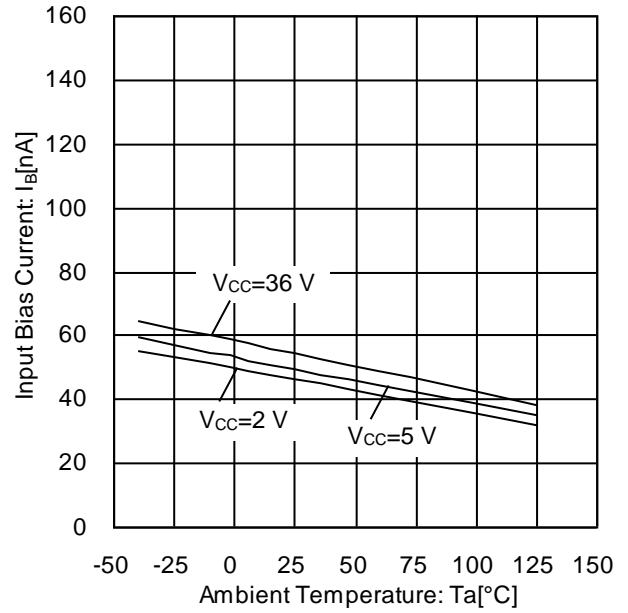

Figure 29. Input Bias Current vs Ambient Temperature

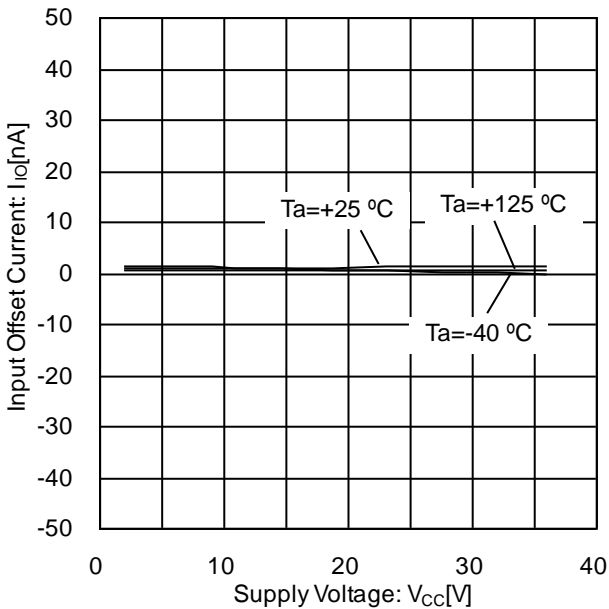

Figure 30. Input Offset Current vs Supply Voltage

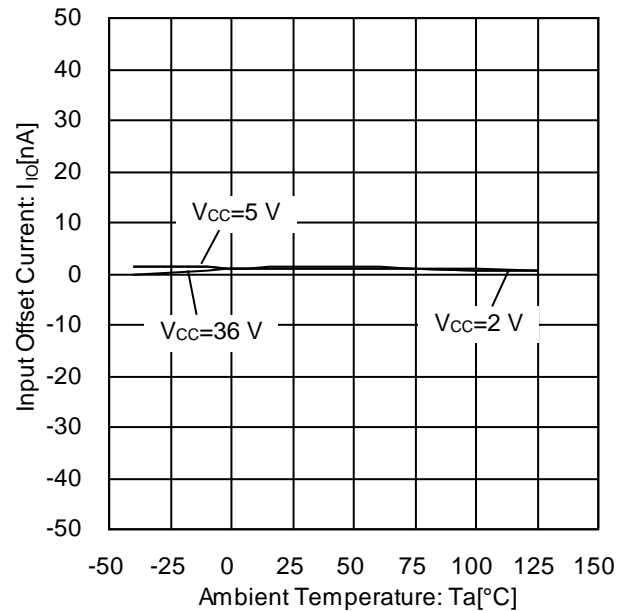

Figure 31. Input Offset Current vs Ambient Temperature

(Note) The data above is measurement value of typical sample; it is not guaranteed.

Typical Performance Curves - continued

○BA82901Yxx-C

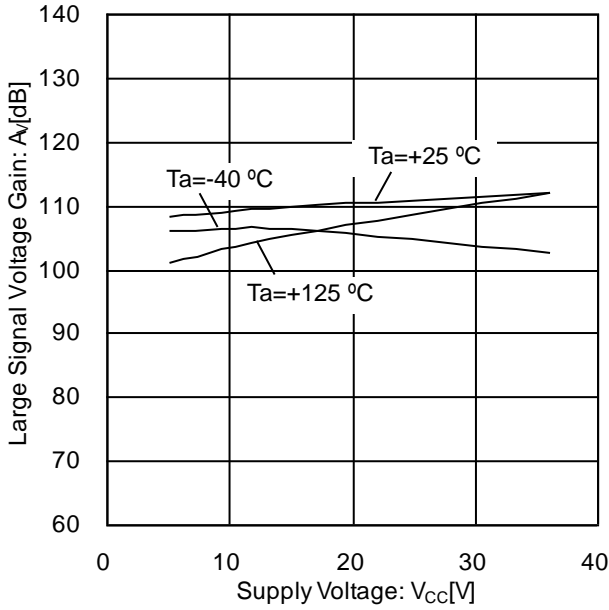

Figure 32. Large Signal Voltage Gain vs Supply Voltage

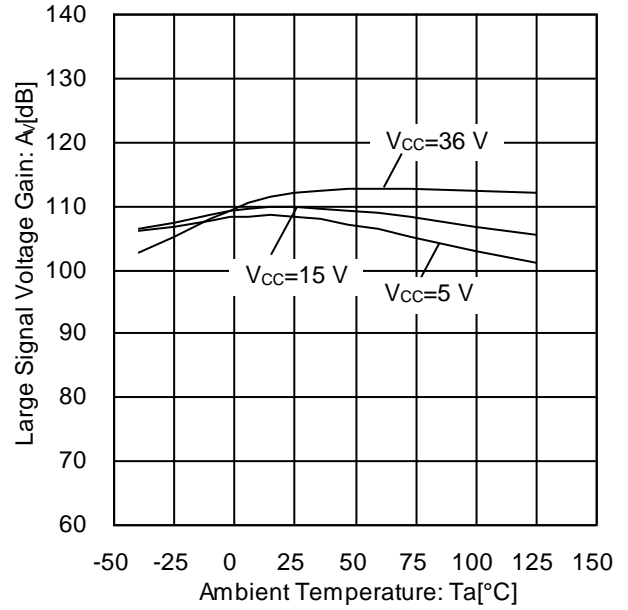

Figure 33. Large Signal Voltage Gain vs Ambient Temperature

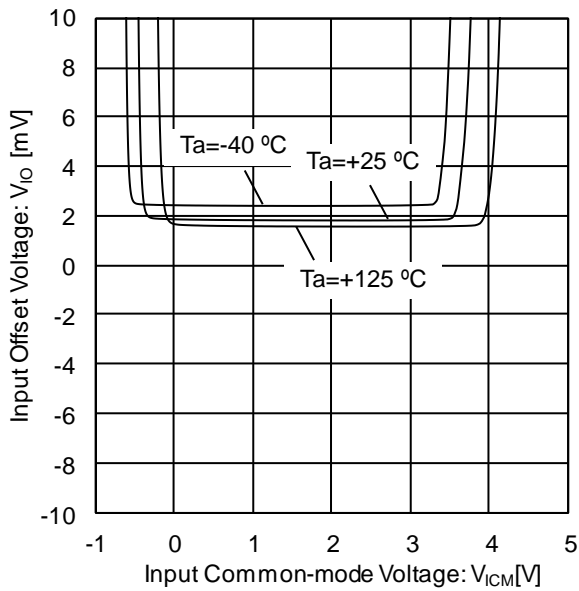

Figure 34. Input Offset Voltage vs Input Voltage (Vcc=5 V)

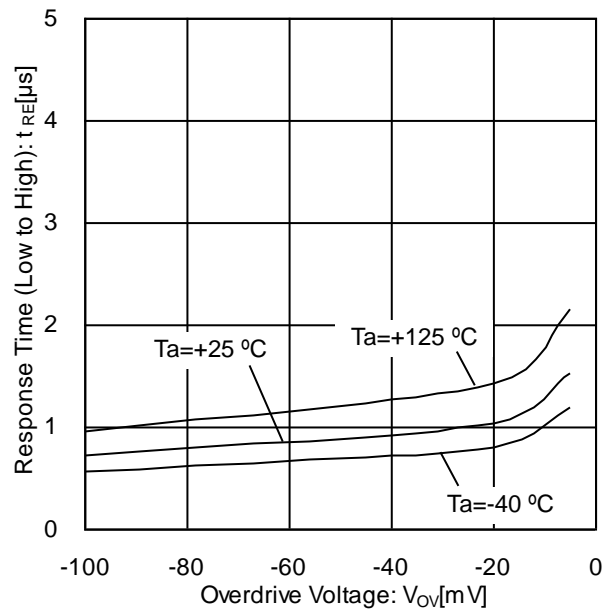

Figure 35. Response Time (Low to High) vs Overdrive Voltage (Vcc=5 V, VRL=5 V, RL=5.1 kΩ)

(Note) The data above is measurement value of typical sample; it is not guaranteed.

Typical Performance Curves - continued

○BA82901Yxx-C

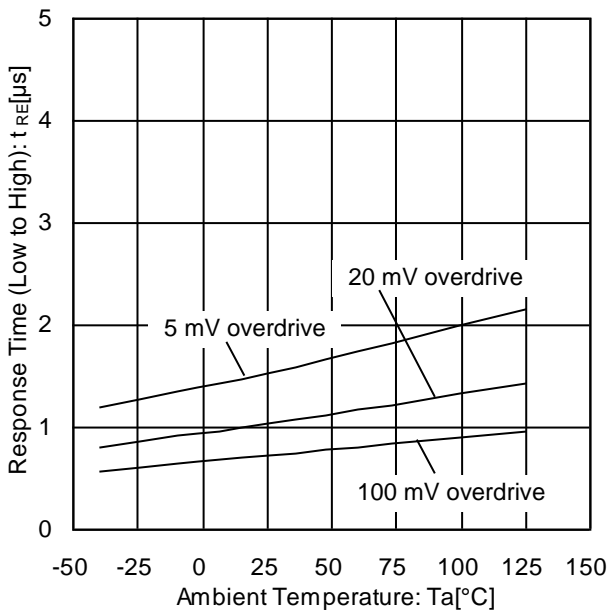

Figure 36. Response Time (Low to High) vs Ambient Temperature
(V_{CC}=5 V, V_{RL}=5 V, R_L=5.1 kΩ)

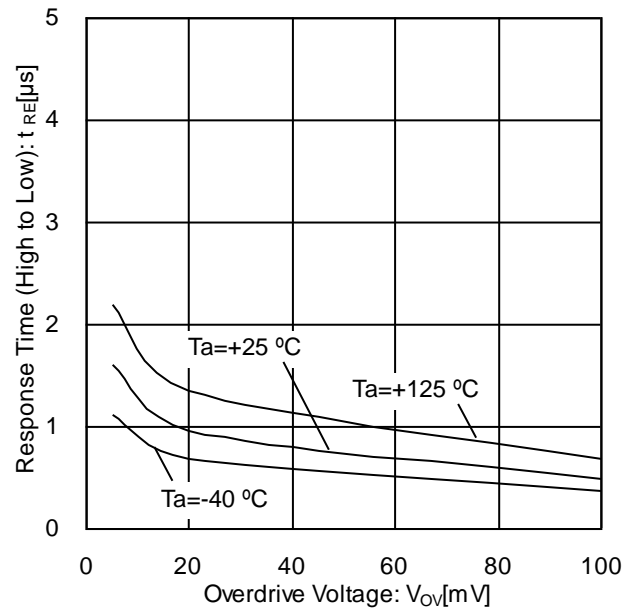

Figure 37. Response Time (High to Low) vs Overdrive Voltage
(V_{CC}=5 V, V_{RL}=5 V, R_L=5.1 kΩ)

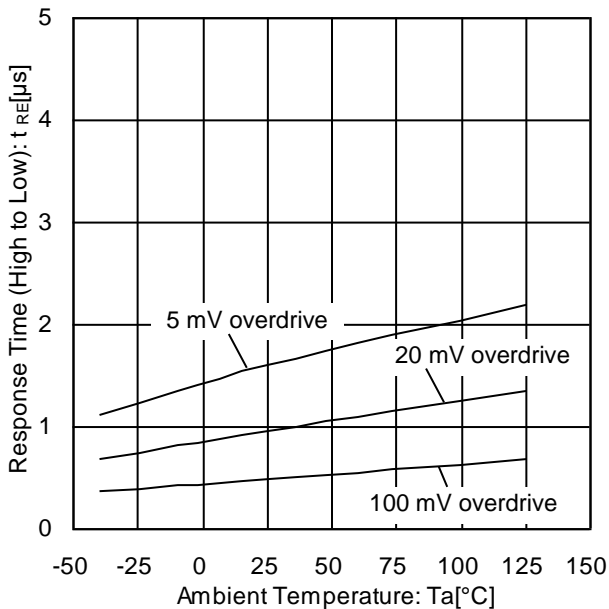

Figure 38. Response Time (High to Low) vs Ambient Temperature
(V_{CC}=5 V, V_{RL}=5 V, R_L=5.1 kΩ)

(Note) The data above is measurement value of typical sample; it is not guaranteed.

Application Information

Test Circuit 1: Measurement Condition

V_{CC}, V_{EE}, V_{EK}, V_{ICM} Unit: V

Parameter	V _F	SW1	SW2	SW3	V _{CC}	V _{EE}	V _{EK}	V _{ICM}	Calculation
Input Offset Voltage	V _{F1}	ON	ON	ON	5 to 36	0	-1.4	0	1
Input Offset Current	V _{F2}	OFF	OFF	ON	5	0	-1.4	0	2
Input Bias Current	V _{F3}	OFF	ON	ON	5	0	-1.4	0	3
	V _{F4}	ON	OFF		5	0	-1.4	0	
Large Signal Voltage Gain	V _{F5}	ON	ON	ON	15	0	-1.4	0	4
	V _{F6}				15	0	-11.4	0	

- Calculation -

1. Input Offset Voltage (V_{IO})

$$V_{IO} = \frac{|V_{F1}|}{1 + R_F/R_S} \text{ [V]}$$

2. Input Offset Current (I_{IO})

$$I_{IO} = \frac{|V_{F2} - V_{F1}|}{R_I \times (1 + R_F/R_S)} \text{ [A]}$$

3. Input Bias Current (I_B)

$$I_B = \frac{|V_{F4} - V_{F3}|}{2 \times R_I \times (1 + R_F/R_S)} \text{ [A]}$$

4. Large Signal Voltage Gain (A_V)

$$A_V = \frac{\Delta V_{EK} \times (1 + R_F/R_S)}{|V_{F5} - V_{F6}|} \text{ [dB]}$$

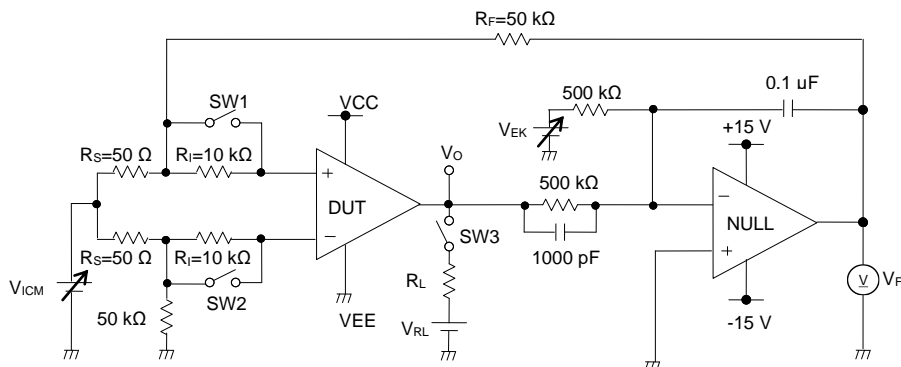

Figure 39. Test Circuit 1 (One Channel Only)

Application Information - continued

Test Circuit 2: Switch Condition

SW No.		SW 1	SW 2	SW 3	SW 4	SW 5	SW 6	SW 7
Supply Current		OFF	ON	ON	OFF	OFF	OFF	OFF
Output Sink Current	$V_{OUT}=1.5\text{ V}$	OFF	ON	ON	OFF	OFF	OFF	ON
Output Saturation Voltage	$I_{SINK}=4\text{ mA}$	OFF	ON	ON	OFF	ON	ON	OFF
Output Leakage Current	$V_{OUT}=36\text{ V}$	OFF	ON	ON	OFF	OFF	OFF	ON
Response Time	$R_L=5.1\text{ k}\Omega, V_{RL}=5\text{ V}$	ON	OFF	ON	ON	OFF	OFF	OFF

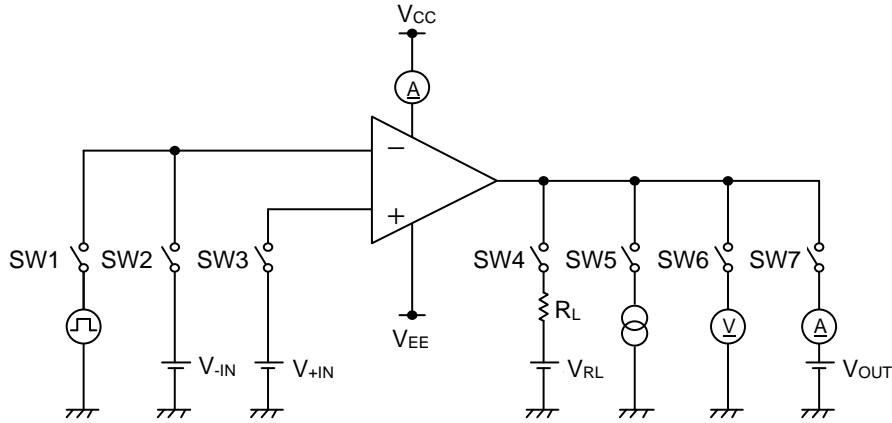

Figure 40. Test Circuit 2 (One Channel Only)

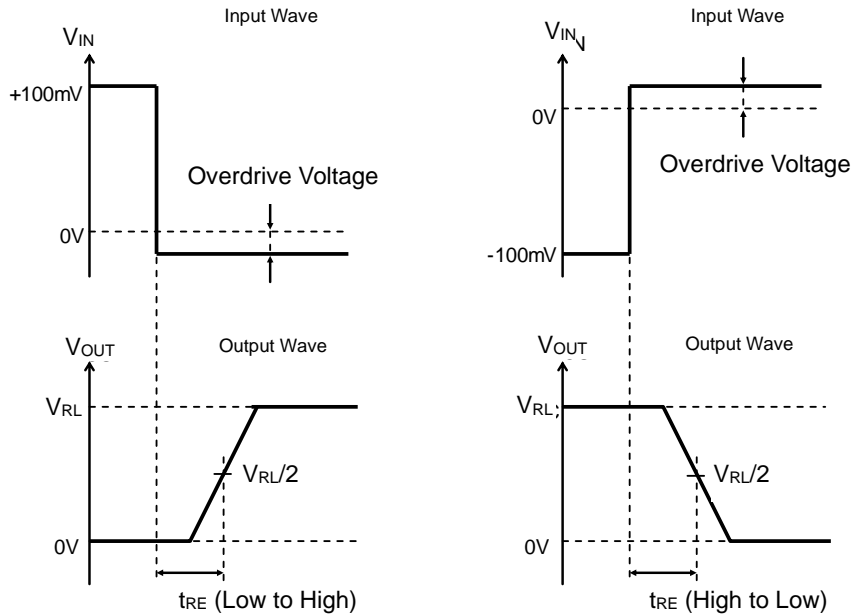
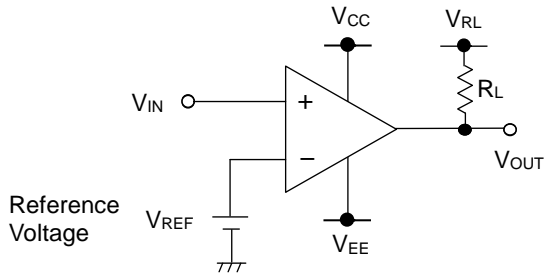

Figure 41. Input / Output Waveform of Response Time

Application Information - continued

Application Example

- Reference voltage is -IN



While the input voltage (V_{IN}) is higher than the reference voltage, the output voltage remains high. In case the input voltage becomes lower than the reference voltage, the output voltage will turn low.

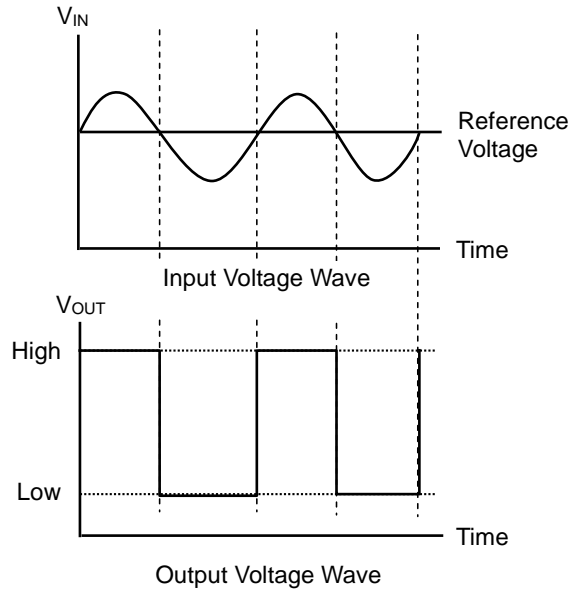

- Reference voltage is +IN

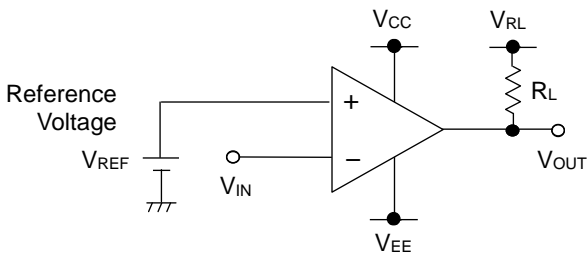

While the input voltage (V_{IN}) is lower than the reference voltage, the output voltage remains high. In case the input voltage becomes higher than the reference voltage, the output voltage will turn low.

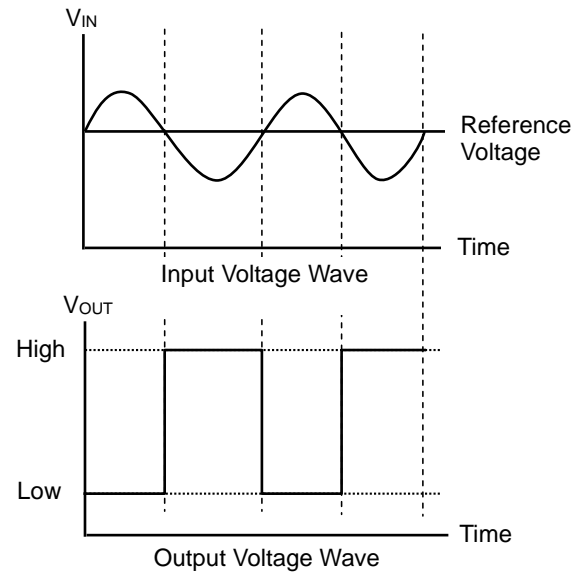

Application Information - continued

EMI Immunity

BA82903Yxxx-C and BA82901Yxx-C have high tolerance for electromagnetic interference from the outside because they have EMI filter, and the EMI design is simple. The data of the IC simple substance on ROHM board are as follows. They are most suitable to replace from conventional products. The test condition is based on ISO11452-2.

<Test Condition> Based on ISO11452-2
 VCC: 12 V, V_{RL}: 6 V, R_L: 5.1 kΩ
 H Level Output: V_{+IN}: 6 V, V_{-IN}: 5.8 V
 L Level Output: V_{+IN}: 5.8 V, V_{-IN}: 6 V
 Test Method: Substituted Law
 (Progressive Wave)
 Field Intensity: 200 V/m
 Test Wave: CW (Continuous Wave)
 Frequency: 200 MHz – 1000 MHz (2 % step)

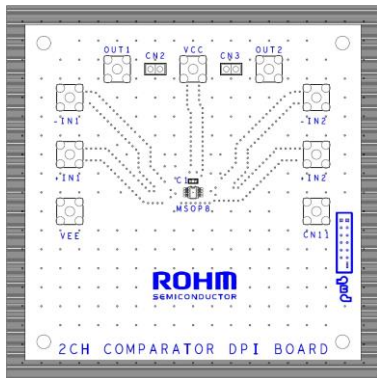

Figure 44. EMI Evaluation Board (BA82903Yxxx-C)

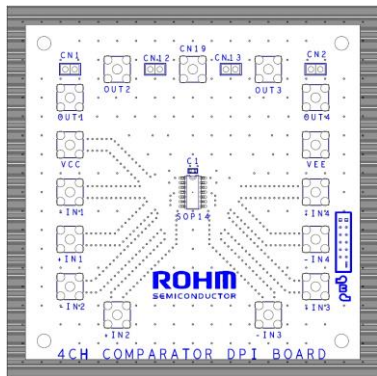

Figure 45. EMI Evaluation Board (BA82901Yxx-C)

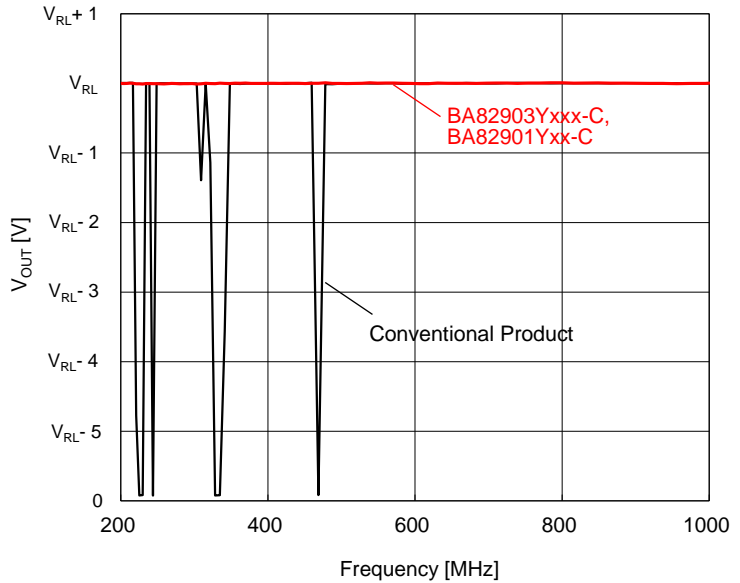

Figure 42. EMI Characteristics (H Level Output)

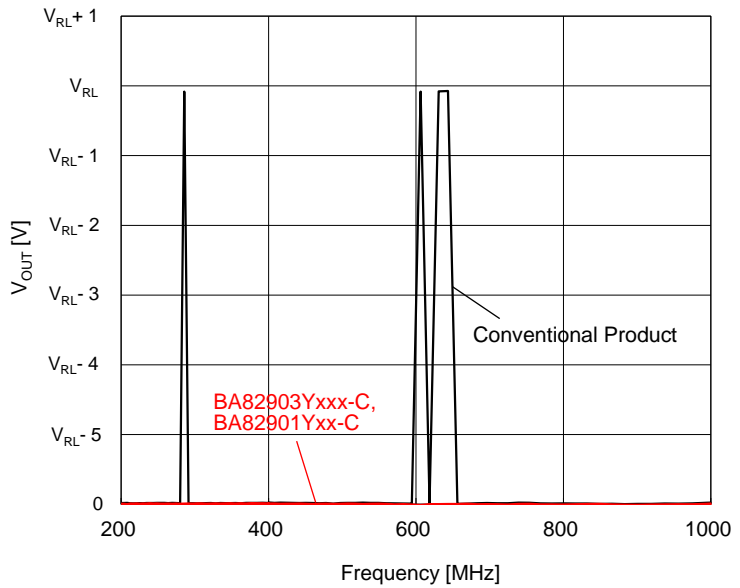

Figure 43. EMI Characteristics (L Level Output)

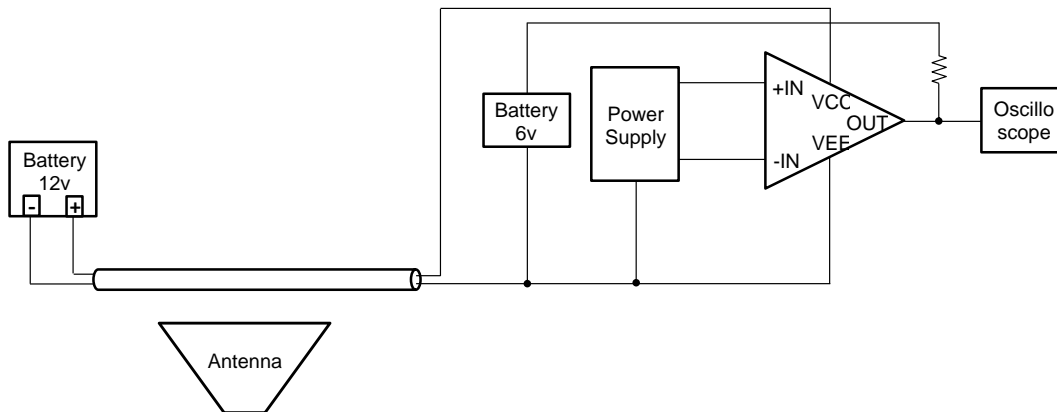

Figure 46. Measurement Circuit of EMI Evaluation

(Note) The above data is obtained using typical IC simple substance on ROHM board. These values are not guaranteed. Design and evaluate in actual application before use.

Application Information – continued

Notes

1. Unused Circuits

When there are unused circuits, it is recommended that they are connected as in Figure 47, and set the non-inverting input pin within the input common-mode voltage range (V_{ICM}).

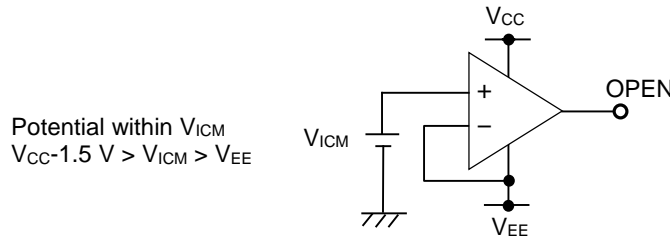

Figure 47. Example of Application Circuit for Unused Circuit

2. Input Voltage

Applying $V_{EE}+36\text{ V}$ to the input pin is possible without causing deterioration of the electrical characteristics or destruction, regardless of the supply voltage. However, this does not ensure normal circuit operation. Note that the circuit operates normally only when the input voltage is within the input common-mode input voltage range of the electric characteristics.

3. Power Supply (Single / Dual)

The comparator operates when the voltage supplied is between the V_{CC} and V_{EE} pin. Therefore, the comparator can operate from single supply or dual supplies.

4. Pin Short-circuits

When the output and the V_{CC} pins are shorted, excessive output current may flow, resulting in undue heat generation and, subsequently, destruction.

5. IC Handling

Applying mechanical stress to the IC by deflecting or bending the board may cause fluctuations of the electrical characteristics due to the piezo resistance effects. Pay attention to defecting or bending the board

I/O Equivalence Circuit

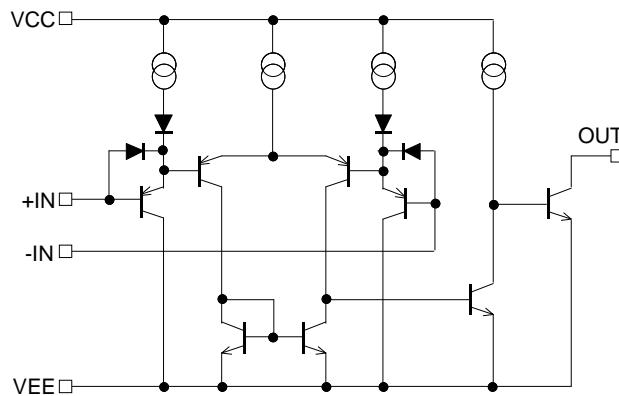

Figure 48. Equivalence Circuit (One Channel Only)

Operational Notes

1. Reverse Connection of Power Supply

Connecting the power supply in reverse polarity can damage the IC. Take precautions against reverse polarity when connecting the power supply, such as mounting an external diode between the power supply and the IC's power supply pins.

2. Power Supply Lines

Design the PCB layout pattern to provide low impedance supply lines. Furthermore, connect a capacitor to ground at all power supply pins. Consider the effect of temperature and aging on the capacitance value when using electrolytic capacitors.

3. Ground Voltage

Ensure that no pins are at a voltage below that of the ground pin at any time, even during transient condition.

4. Ground Wiring Pattern

When using both small-signal and large-current ground traces, the two ground traces should be routed separately but connected to a single ground at the reference point of the application board to avoid fluctuations in the small-signal ground caused by large currents. Also ensure that the ground traces of external components do not cause variations on the ground voltage. The ground lines must be as short and thick as possible to reduce line impedance.

5. Recommended Operating Conditions

The function and operation of the IC are guaranteed within the range specified by the recommended operating conditions. The characteristic values are guaranteed only under the conditions of each item specified by the electrical characteristics.

6. Inrush Current

When power is first supplied to the IC, it is possible that the internal logic may be unstable and inrush current may flow instantaneously due to the internal powering sequence and delays, especially if the IC has more than one power supply. Therefore, give special consideration to power coupling capacitance, power wiring, width of ground wiring, and routing of connections.

7. Operation Under Strong Electromagnetic Field

Operating the IC in the presence of a strong electromagnetic field may cause the IC to malfunction.

8. Testing on Application Boards

When testing the IC on an application board, connecting a capacitor directly to a low-impedance output pin may subject the IC to stress. Always discharge capacitors completely after each process or step. The IC's power supply should always be turned off completely before connecting or removing it from the test setup during the inspection process. To prevent damage from static discharge, ground the IC during assembly and use similar precautions during transport and storage.

9. Inter-pin Short and Mounting Errors

Ensure that the direction and position are correct when mounting the IC on the PCB. Incorrect mounting may result in damaging the IC. Avoid nearby pins being shorted to each other especially to ground, power supply and output pin. Inter-pin shorts could be due to many reasons such as metal particles, water droplets (in very humid environment) and unintentional solder bridge deposited in between pins during assembly to name a few.

10. Unused Input Pins

Input pins of an IC are often connected to the gate of a MOS transistor. The gate has extremely high impedance and extremely low capacitance. If left unconnected, the electric field from the outside can easily charge it. The small charge acquired in this way is enough to produce a significant effect on the conduction through the transistor and cause unexpected operation of the IC. So unless otherwise specified, unused input pins should be connected to the power supply or ground line.

Operational Notes – continued

11. Regarding the Input Pin of the IC

This monolithic IC contains P+ isolation and P substrate layers between adjacent elements in order to keep them isolated. P-N junctions are formed at the intersection of the P layers with the N layers of other elements, creating a parasitic diode or transistor. For example (refer to figure below):

When GND > Pin A and GND > Pin B, the P-N junction operates as a parasitic diode.
 When GND > Pin B, the P-N junction operates as a parasitic transistor.

Parasitic diodes inevitably occur in the structure of the IC. The operation of parasitic diodes can result in mutual interference among circuits, operational faults, or physical damage. Therefore, conditions that cause these diodes to operate, such as applying a voltage lower than the GND voltage to an input pin (and thus to the P substrate) should be avoided.

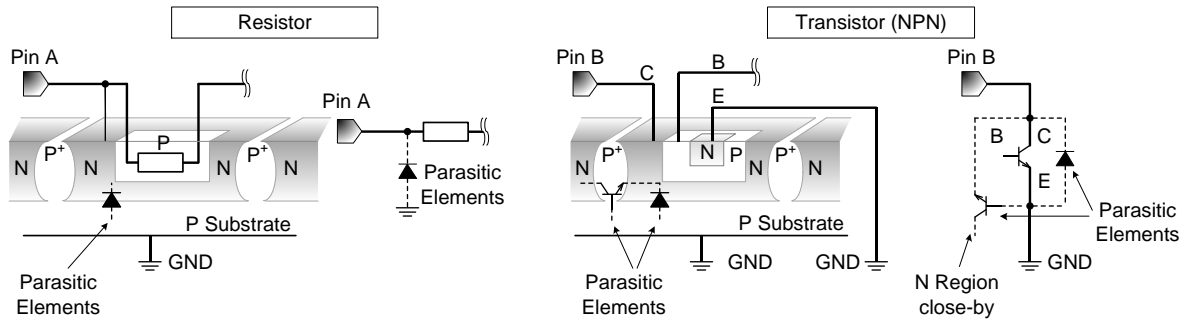

Figure 49. Example of Monolithic IC Structure

12. Ceramic Capacitor

When using a ceramic capacitor, determine a capacitance value considering the change of capacitance with temperature and the decrease in nominal capacitance due to DC bias and others.

13. Area of Safe Operation (ASO)

Operate the IC such that the output voltage, output current, and the maximum junction temperature rating are all within the Area of Safe Operation (ASO).

Ordering Information

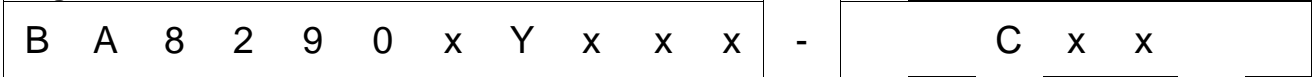

Number of Channels 3: Dual 1: Quad	Package F : SOP8 SOP14 FV : SSOP-B14 FVM: MSOP8	Product Rank C: for Automotive Packaging and forming specification E2: Embossed tape and reel (SOP8/SOP14/SSOP-B14) TR: Embossed tape and reel (MSOP8)
---	--	--

Lineup

Operating Temperature Range	Operating Supply Voltage	Number of Channels	Package		Orderable Part Number
-40 °C to +125 °C	2 V to 36 V	Dual	SOP8	Reel of 2500	BA82903YF-CE2
			MSOP8	Reel of 3000	BA82903YFVM-CTR
		Quad	SOP14	Reel of 2500	BA82901YF-CE2
			SSOP-B14	Reel of 2500	BA82901YFV-CE2

Marking Diagrams

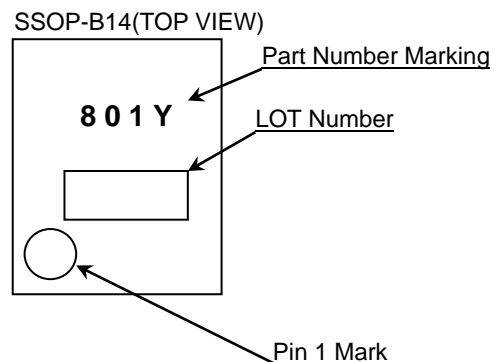
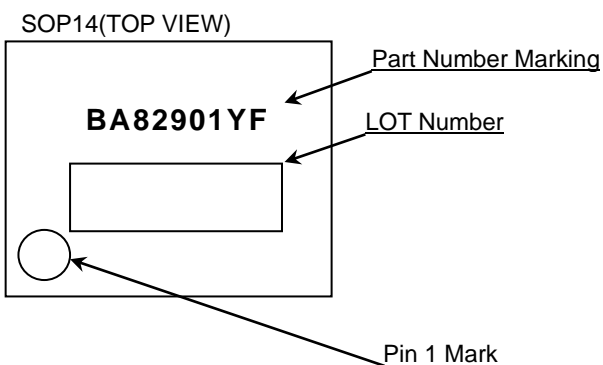
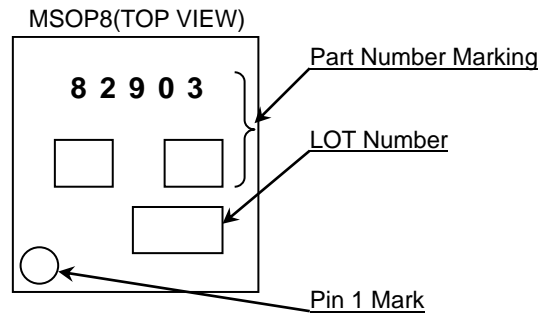
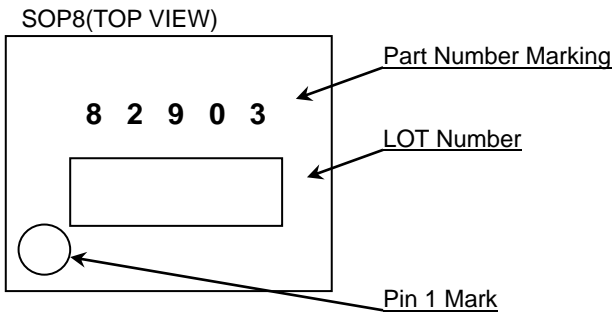

Physical Dimension and Packing Information

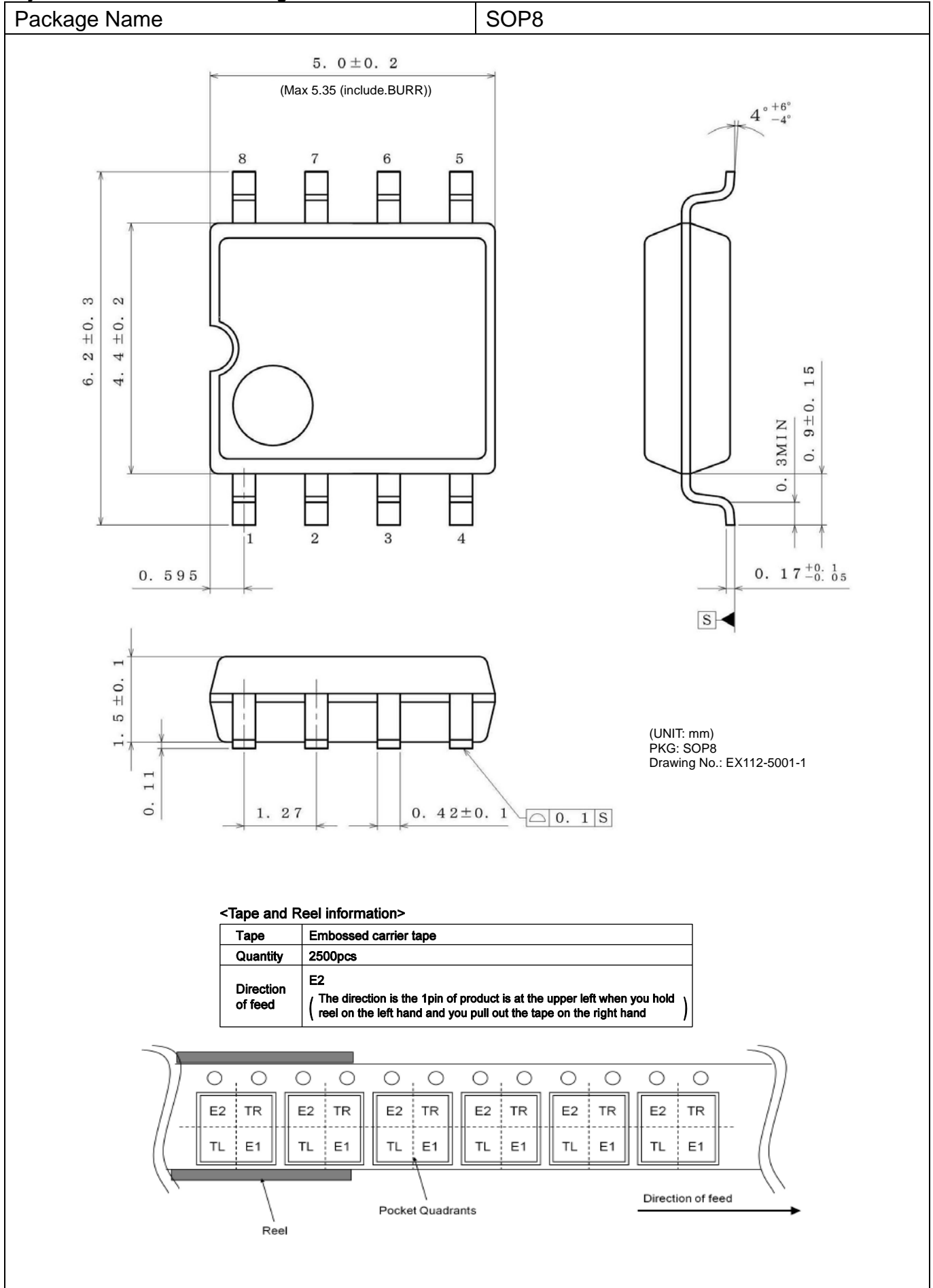

Physical Dimension and Packing Information – continued

Package Name	SOP14
--------------	-------

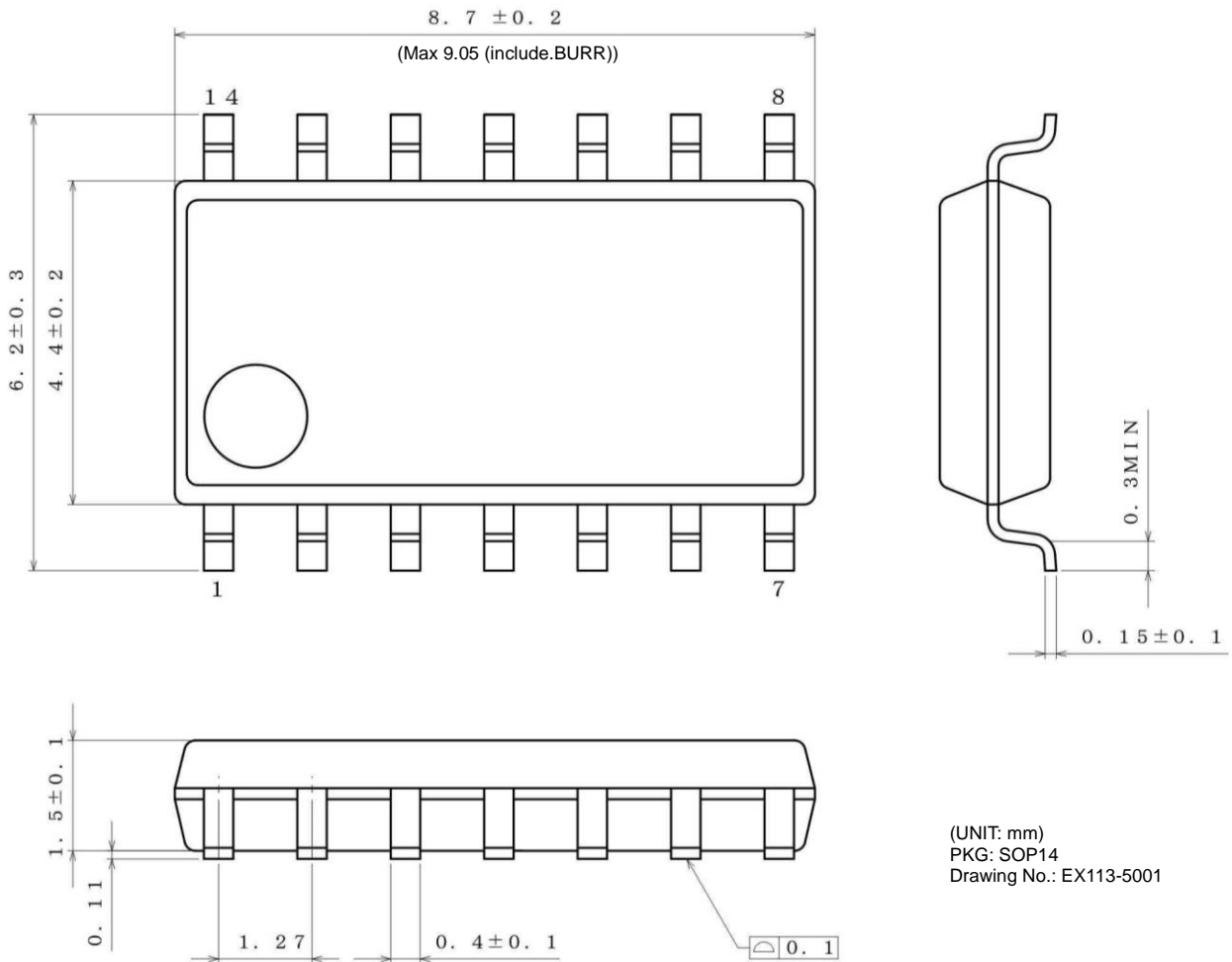

(UNIT: mm)
 PKG: SOP14
 Drawing No.: EX113-5001

<Tape and Reel information>

Tape	Embossed carrier tape
Quantity	2500pcs
Direction of feed	E2 (The direction is the 1pin of product is at the upper left when you hold reel on the left hand and you pull out the tape on the right hand)

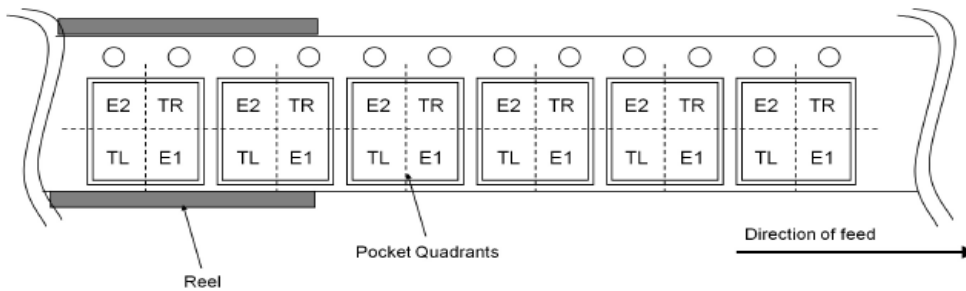

Physical Dimension and Packing Information – continued

Package Name	SSOP-B14
--------------	----------

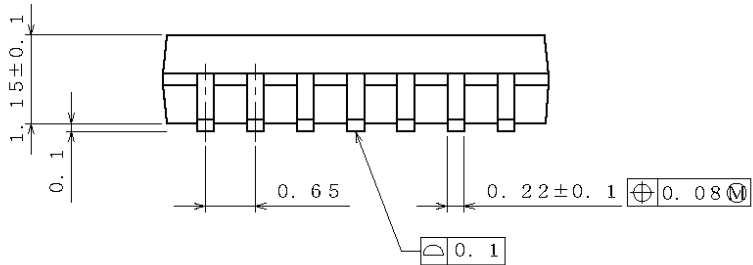
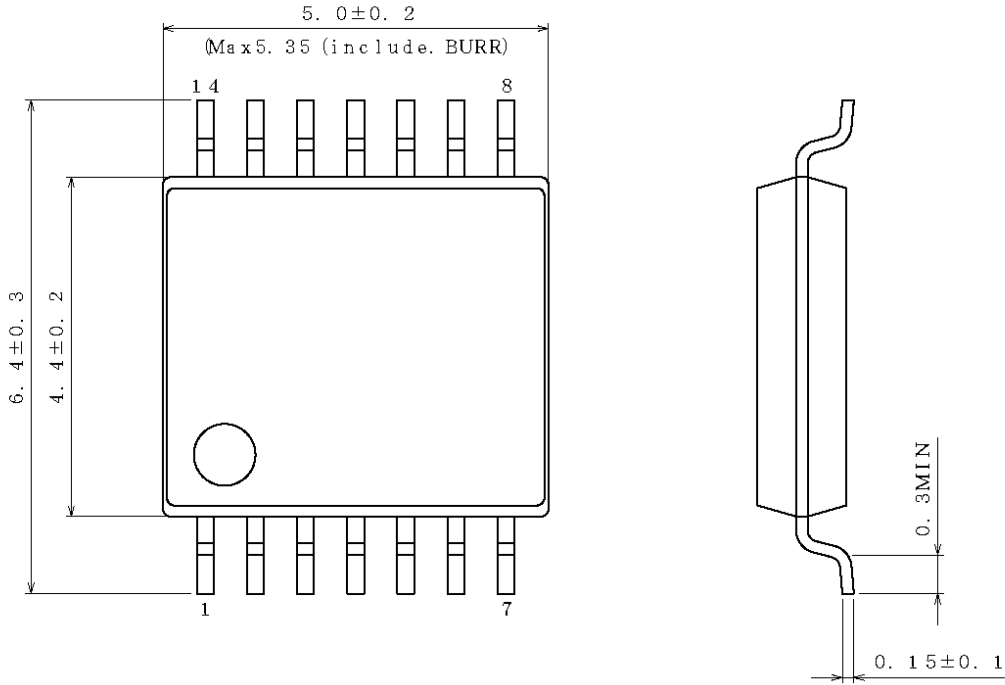

(UNIT : mm)
 PKG : SSOP-B14
 Drawing No. EX152-5002

<Tape and Reel information>

Tape	Embossed carrier tape
Quantity	2500pcs
Direction of feed	E2 (The direction is the 1pin of product is at the upper left when you hold reel on the left hand and you pull out the tape on the right hand)

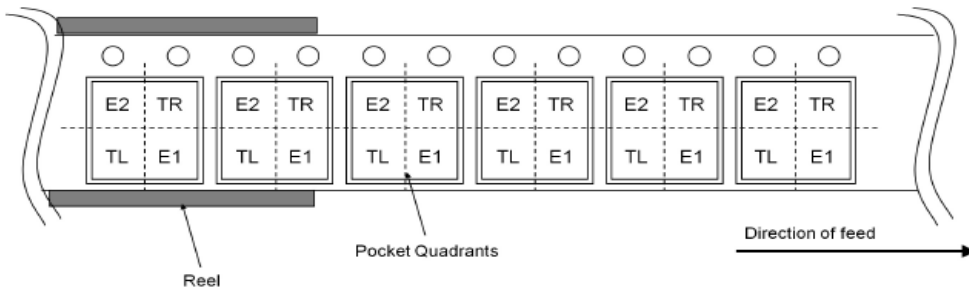

Physical Dimension and Packing Information – continued

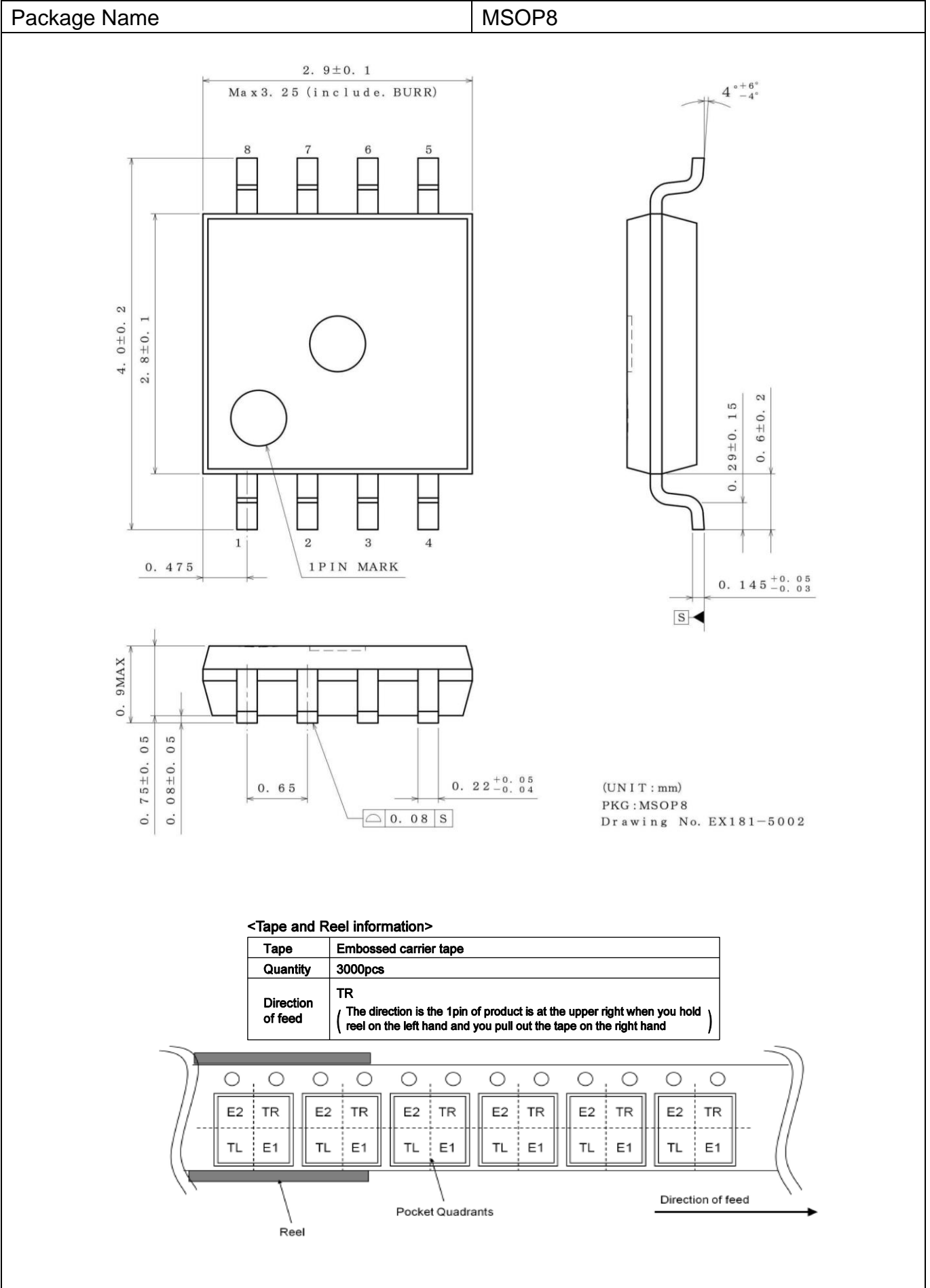

Revision History

Date	Revision	Changes
26.Jun.2018	001	New Release
21.Sep.2022	002	Modified Title

Notice

Precaution on using ROHM Products

1. If you intend to use our Products in devices requiring extremely high reliability (such as medical equipment ^(Note 1), aircraft/spacecraft, nuclear power controllers, etc.) and whose malfunction or failure may cause loss of human life, bodily injury or serious damage to property ("Specific Applications"), please consult with the ROHM sales representative in advance. Unless otherwise agreed in writing by ROHM in advance, ROHM shall not be in any way responsible or liable for any damages, expenses or losses incurred by you or third parties arising from the use of any ROHM's Products for Specific Applications.

(Note1) Medical Equipment Classification of the Specific Applications

JAPAN	USA	EU	CHINA
CLASS III	CLASS III	CLASS II b	CLASS III
CLASS IV		CLASS III	

2. ROHM designs and manufactures its Products subject to strict quality control system. However, semiconductor products can fail or malfunction at a certain rate. Please be sure to implement, at your own responsibilities, adequate safety measures including but not limited to fail-safe design against the physical injury, damage to any property, which a failure or malfunction of our Products may cause. The following are examples of safety measures:
 - [a] Installation of protection circuits or other protective devices to improve system safety
 - [b] Installation of redundant circuits to reduce the impact of single or multiple circuit failure
3. Our Products are not designed under any special or extraordinary environments or conditions, as exemplified below. Accordingly, ROHM shall not be in any way responsible or liable for any damages, expenses or losses arising from the use of any ROHM's Products under any special or extraordinary environments or conditions. If you intend to use our Products under any special or extraordinary environments or conditions (as exemplified below), your independent verification and confirmation of product performance, reliability, etc. prior to use, must be necessary:
 - [a] Use of our Products in any types of liquid, including water, oils, chemicals, and organic solvents
 - [b] Use of our Products outdoors or in places where the Products are exposed to direct sunlight or dust
 - [c] Use of our Products in places where the Products are exposed to sea wind or corrosive gases, including Cl₂, H₂S, NH₃, SO₂, and NO₂
 - [d] Use of our Products in places where the Products are exposed to static electricity or electromagnetic waves
 - [e] Use of our Products in proximity to heat-producing components, plastic cords, or other flammable items
 - [f] Sealing or coating our Products with resin or other coating materials
 - [g] Use of our Products without cleaning residue of flux (Exclude cases where no-clean type fluxes is used. However, recommend sufficiently about the residue.); or Washing our Products by using water or water-soluble cleaning agents for cleaning residue after soldering
 - [h] Use of the Products in places subject to dew condensation
4. The Products are not subject to radiation-proof design.
5. Please verify and confirm characteristics of the final or mounted products in using the Products.
6. In particular, if a transient load (a large amount of load applied in a short period of time, such as pulse, is applied, confirmation of performance characteristics after on-board mounting is strongly recommended. Avoid applying power exceeding normal rated power; exceeding the power rating under steady-state loading condition may negatively affect product performance and reliability.
7. De-rate Power Dissipation depending on ambient temperature. When used in sealed area, confirm that it is the use in the range that does not exceed the maximum junction temperature.
8. Confirm that operation temperature is within the specified range described in the product specification.
9. ROHM shall not be in any way responsible or liable for failure induced under deviant condition from what is defined in this document.

Precaution for Mounting / Circuit board design

1. When a highly active halogenous (chlorine, bromine, etc.) flux is used, the residue of flux may negatively affect product performance and reliability.
2. In principle, the reflow soldering method must be used on a surface-mount products, the flow soldering method must be used on a through hole mount products. If the flow soldering method is preferred on a surface-mount products, please consult with the ROHM representative in advance.

For details, please refer to ROHM Mounting specification

Precautions Regarding Application Examples and External Circuits

1. If change is made to the constant of an external circuit, please allow a sufficient margin considering variations of the characteristics of the Products and external components, including transient characteristics, as well as static characteristics.
2. You agree that application notes, reference designs, and associated data and information contained in this document are presented only as guidance for Products use. Therefore, in case you use such information, you are solely responsible for it and you must exercise your own independent verification and judgment in the use of such information contained in this document. ROHM shall not be in any way responsible or liable for any damages, expenses or losses incurred by you or third parties arising from the use of such information.

Precaution for Electrostatic

This Product is electrostatic sensitive product, which may be damaged due to electrostatic discharge. Please take proper caution in your manufacturing process and storage so that voltage exceeding the Products maximum rating will not be applied to Products. Please take special care under dry condition (e.g. Grounding of human body / equipment / solder iron, isolation from charged objects, setting of Ionizer, friction prevention and temperature / humidity control).

Precaution for Storage / Transportation

1. Product performance and soldered connections may deteriorate if the Products are stored in the places where:
 - [a] the Products are exposed to sea winds or corrosive gases, including Cl₂, H₂S, NH₃, SO₂, and NO₂
 - [b] the temperature or humidity exceeds those recommended by ROHM
 - [c] the Products are exposed to direct sunshine or condensation
 - [d] the Products are exposed to high Electrostatic
2. Even under ROHM recommended storage condition, solderability of products out of recommended storage time period may be degraded. It is strongly recommended to confirm solderability before using Products of which storage time is exceeding the recommended storage time period.
3. Store / transport cartons in the correct direction, which is indicated on a carton with a symbol. Otherwise bent leads may occur due to excessive stress applied when dropping of a carton.
4. Use Products within the specified time after opening a humidity barrier bag. Baking is required before using Products of which storage time is exceeding the recommended storage time period.

Precaution for Product Label

A two-dimensional barcode printed on ROHM Products label is for ROHM's internal use only.

Precaution for Disposition

When disposing Products please dispose them properly using an authorized industry waste company.

Precaution for Foreign Exchange and Foreign Trade act

Since concerned goods might be fallen under listed items of export control prescribed by Foreign exchange and Foreign trade act, please consult with ROHM in case of export.

Precaution Regarding Intellectual Property Rights

1. All information and data including but not limited to application example contained in this document is for reference only. ROHM does not warrant that foregoing information or data will not infringe any intellectual property rights or any other rights of any third party regarding such information or data.
2. ROHM shall not have any obligations where the claims, actions or demands arising from the combination of the Products with other articles such as components, circuits, systems or external equipment (including software).
3. No license, expressly or implied, is granted hereby under any intellectual property rights or other rights of ROHM or any third parties with respect to the Products or the information contained in this document. Provided, however, that ROHM will not assert its intellectual property rights or other rights against you or your customers to the extent necessary to manufacture or sell products containing the Products, subject to the terms and conditions herein.

Other Precaution

1. This document may not be reprinted or reproduced, in whole or in part, without prior written consent of ROHM.
2. The Products may not be disassembled, converted, modified, reproduced or otherwise changed without prior written consent of ROHM.
3. In no event shall you use in any way whatsoever the Products and the related technical information contained in the Products or this document for any military purposes, including but not limited to, the development of mass-destruction weapons.
4. The proper names of companies or products described in this document are trademarks or registered trademarks of ROHM, its affiliated companies or third parties.

General Precaution

1. Before you use our Products, you are requested to carefully read this document and fully understand its contents. ROHM shall not be in any way responsible or liable for failure, malfunction or accident arising from the use of any ROHM's Products against warning, caution or note contained in this document.
2. All information contained in this document is current as of the issuing date and subject to change without any prior notice. Before purchasing or using ROHM's Products, please confirm the latest information with a ROHM sales representative.
3. The information contained in this document is provided on an "as is" basis and ROHM does not warrant that all information contained in this document is accurate and/or error-free. ROHM shall not be in any way responsible or liable for any damages, expenses or losses incurred by you or third parties resulting from inaccuracy or errors of or concerning such information.