

TLV370x Family of Nanopower, Push-Pull Output Comparators

1 Features

- Low Supply Current ... 560 nA/Per Channel
- Input Common-Mode Range Exceeds the Rails ... -0.1 V to $V_{CC} + 5\text{ V}$
- Supply Voltage Range ... 2.5 V to 16 V
- Reverse Battery Protection Up to 18 V
- Push-Pull CMOS Output Stage
- Specified Temperature Range
 - 0°C to 70°C – Commercial Grade
 - -40°C to 125°C – Industrial Grade
- Ultra-Small Packaging
 - 5-Pin SOT-23 (TLV3701)
 - 8-Pin MSOP (TLV3702)
- Universal Op-Amp EVM (Reference SLOU060 for More Information)

2 Applications

- Portable Battery Monitoring
- Consumer Medical Electronics
- Security Detection Systems
- Handheld Instruments
- Ultra-Low Power Systems

3 Description

The TLV370x is Texas Instruments' first family of nanopower comparators with only 560 nA per channel supply current, which make this device ideal for battery power and wireless handset applications.

The TLV370x has a minimum operating supply voltage of 2.7 V over the extended industrial temperature range ($T_A = -40^{\circ}\text{C}$ to 125°C), while having an input common-mode range of -0.1 to $V_{CC} + 5\text{ V}$. The low supply current makes it an ideal choice for battery-powered portable applications where quiescent current is the primary concern. Reverse battery protection guards the amplifier from an overcurrent condition due to improper battery installation. For harsh environments, the inputs can be taken 5 V above the positive supply rail without damage to the device.

All members are available in PDIP and SOIC with the singles in the small SOT-23 package, duals in the MSOP, and quads in the TSSOP package.

Device Information⁽¹⁾

PART NUMBER	PACKAGE	BODY SIZE (NOM)
TLV3701	SOT-23 (5)	2.90 mm x 1.60 mm
	SOIC (8)	4.90 mm x 3.91 mm
TLV3702	SOIC (8)	4.90 mm x 3.91 mm
	VSSOP (8)	3.00 mm x 3.00 mm
	PDIP (8)	9.81 mm x 6.35 mm
TLV3704	SOIC (14)	8.65 mm x 3.91 mm
	PDIP (14)	19.30 mm x 6.35 mm
	TSSOP (14)	5.00 mm x 4.40 mm

(1) For all available packages, see the orderable addendum at the end of the data sheet.

Supply Current vs Supply Voltage



High-Side Voltage Sense Circuit

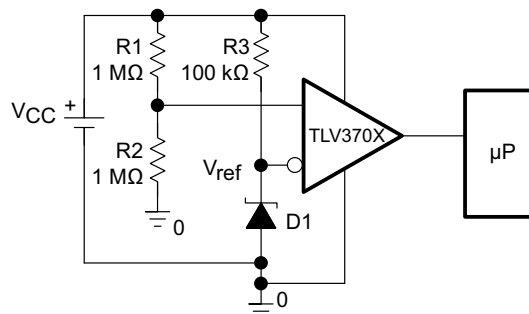

Copyright © 2016, Texas Instruments Incorporated



Table of Contents

1 Features 1 2 Applications 1 3 Description 1 4 Revision History 2 5 Device Comparison Tables 3 6 Pin Configuration and Functions 4 7 Specifications 6 7.1 Absolute Maximum Ratings 6 7.2 Recommended Operating Conditions 6 7.3 Thermal Information – TLV3701 7 7.4 Thermal Information – TLV3702 7 7.5 Thermal Information – TLV3704 7 7.6 Electrical Characteristics 8 7.7 Switching Characteristics 9 7.8 Dissipation Ratings 9 7.9 Typical Characteristics 10 8 Detailed Description 13 8.1 Overview 13 8.2 Functional Block Diagram 13	8.3 Feature Description 13 8.4 Device Functional Modes 13 9 Application and Implementation 14 9.1 Application Information 14 9.2 Typical Application 14 10 Power Supply Recommendations 16 11 Layout 16 11.1 Layout Guidelines 16 11.2 Layout Example 16 12 Device and Documentation Support 17 12.1 Device Support 17 12.2 Documentation Support 17 12.3 Related Links 17 12.4 Receiving Notification of Documentation Updates 17 12.5 Community Resources 18 12.6 Trademarks 18 12.7 Electrostatic Discharge Caution 18 12.8 Glossary 18 13 Mechanical, Packaging, and Orderable Information 18
--	--

4 Revision History

Changes from Revision C (March 2017) to Revision D	Page
<ul style="list-style-type: none"> • Changed Wording of Start-up time table note 9 	9
Changes from Revision B (August 2001) to Revision C	Page
<ul style="list-style-type: none"> • Added <i>Device Information</i> table, <i>Device Comparison</i> table, <i>ESD Ratings</i> table, <i>Feature Description</i> section, <i>Device Functional Modes</i>, <i>Application and Implementation</i> section, <i>Power Supply Recommendations</i> section, <i>Layout</i> section, <i>Device and Documentation Support</i> section, and <i>Mechanical, Packaging, and Orderable Information</i> section 1 • Changed VOH typical value from 0.08 to 80 to reflect proper units 8 • Changed Dissipation Ratings Table to reflect new package thermals 9 • Deleted extraneous "Open Collector Leakage" graph 10 	10

5 Device Comparison Tables

Table 1. Selection of Comparators⁽¹⁾

DEVICE	V _{CC} (V)	V _{IO} (μV)	I _{CC} /Ch (μA)	I _B (pA)	t _{PLH} (μs)	t _{PHL} (μs)	t _f (μs)	t _r (μs)	RAIL-TO-RAIL	OUTPUT STAGE
TLV370x	2.5 – 16	250	0.56	80	56	83	22	8	I	PP
TLV340x	2.5 – 16	250	0.47	80	55	30	5	—	I	OD
TLC3702/4	3 – 16	1200	9	5	1.1	0.65	0.5	0.125	—	PP
TLC393/339	3 – 16	1400	11	5	1.1	0.55	0.22	—	—	OD
TLC372/4	3 – 16	1000	75	5	0.65	0.65	—	—	—	OD

(1) All specifications are typical values measured at 5 V.

Table 2. TLV3701 Available Options

T _A	V _{IO} max AT 25°C	PACKAGED DEVICES			
		SMALL OUTLINE (D) ⁽¹⁾	SOT-23 (DBV) ⁽²⁾	SYMBOL	PLASTIC DIP (P)
0°C to 70°C	5000 μV	TLV3701CD	TLV3701CDBV	VBCC	—
–40°C to 125°C		TLV3701ID	TLV3701IDBV	VBCI	TLV3701IP

(1) This package is available taped and reeled. To order this packaging option, add an R suffix to the part number (for example, TLV3701CDR).

(2) This package is only available taped and reeled. For standard quantities (3000 pieces per reel), add an R suffix (that is, TLV3701CDBVR). For small quantities (250 pieces per mini-reel), add a T suffix to the part number (for example, TLV3701CDBVT).

Table 3. TLV3702 Available Options

T _A	V _{IO} max AT 25°C	PACKAGED DEVICES			
		SMALL OUTLINE (D) ⁽¹⁾	MSOP (DGK)	SYMBOL	PLASTIC DIP (P)
0°C to 70°C	5000 μV	TLV3702CD	TLV3702CDGK	xxTIAKC	—
–40°C to 125°C		TLV3702ID	TLV3702IDGK	xxTIAKD	TLV3702IP

(1) This package is available taped and reeled. To order this packaging option, add an R suffix to the part number (for example, TLV3702CDR).

Table 4. TLV3704 Available Options

T _A	V _{IO} max AT 25°C	PACKAGED DEVICES		
		SMALL OUTLINE (D) ⁽¹⁾	PLASTIC DIP (N)	TSSOP (PW)
0°C to 70°C	5000 μV	TLV3704CD	—	TLV3704CPW
–40°C to 125°C		TLV3704ID	TLV3704IN	TLV3704IPW

(1) This package is available taped and reeled. To order this packaging option, add an R suffix to the part number (for example, TLV3704CDR).

6 Pin Configuration and Functions

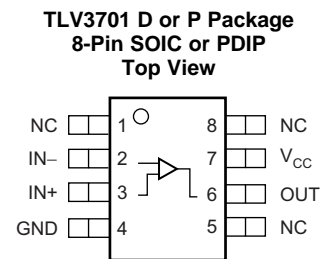
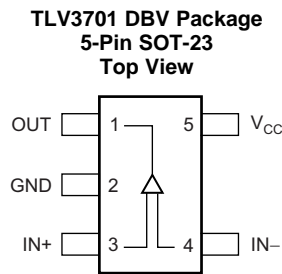
TLV3701 Pin Functions

NAME	PIN		I/O	DESCRIPTION
	SOT-23	SOIC, PDIP		
GND	2	4	—	Ground
IN-	4	2	I	Negative (inverting) input
IN+	3	3	I	Positive (noninverting) input
NC	—	1, 5, 8	—	No internal connection (can be left floating)
OUT	1	6	O	Output
V _{CC}	5	7	—	Positive power supply

TLV3702 D, DGK, or P Package
8-Pin SOIC, VSSOP, or PDIP
Top View

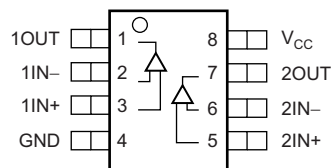
TLV3702 Pin Functions

NAME	PIN		I/O	DESCRIPTION
	NO.			
GND	4		—	Ground
1IN-	2		I	Inverting input, channel 1
2IN-	6		I	Inverting input, channel 2
1IN+	3		I	Noninverting input, channel 1
2IN+	5		I	Noninverting input, channel 2
1OUT	1		O	Output, channel 1
2OUT	7		O	Output, channel 2
V _{CC}	8		—	Positive power supply

**TLV3704 D, N, or PW Package
14-Pin SOIC, PDIP, or TSSOP
Top View**

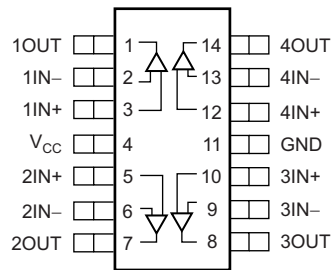

TLV3704 Pin Functions

PIN		I/O	DESCRIPTION
NAME	NO.		
GND	11	—	Ground
1IN-	2	I	Inverting input, channel 1
2IN-	6	I	Inverting input, channel 2
3IN-	9	I	Inverting input, channel 3
4IN-	13	I	Inverting input, channel 4
1IN+	3	I	Noninverting input, channel 1
2IN+	5	I	Noninverting input, channel 2
3IN+	10	I	Noninverting input, channel 3
4IN+	12	I	Noninverting input, channel 4
1OUT	1	O	Output, channel 1
2OUT	7	O	Output, channel 2
3OUT	8	O	Output, channel 3
4OUT	14	O	Output, channel 4
V _{CC}	4	—	Positive power supply

7 Specifications

7.1 Absolute Maximum Ratings

 over operating free-air temperature range (unless otherwise noted)⁽¹⁾

	MIN	MAX	UNIT
Supply voltage, V_{CC} ⁽²⁾		17	V
Differential input voltage, V_{ID}		±20	V
Input voltage, V_I ⁽²⁾⁽³⁾	0	$V_{CC} + 5$	V
Input current, I_I		±10	mA
Output current, I_O		±10	mA
Continuous total power dissipation	See Dissipation Ratings		
Maximum junction temperature, T_J		150	°C
Lead temperature 1,6 mm (1/16 inch) from case for 10 seconds		260	°C
Storage temperature, T_{stg}	–65	150	°C

(1) Stresses beyond those listed under *Absolute Maximum Ratings* may cause permanent damage to the device. These are stress ratings only, which do not imply functional operation of the device at these or any other conditions beyond those indicated under *Recommended Operating Conditions*. Exposure to absolute-maximum-rated conditions for extended periods may affect device reliability.

(2) All voltage values, except differential voltages, are with respect to GND.

(3) Input voltage range is limited to 20 V maximum or $V_{CC} + 5$ V, whichever is smaller.

7.2 Recommended Operating Conditions

over operating free-air temperature range (unless otherwise noted)

			MIN	MAX	UNIT
Supply voltage, V_{CC}	Single supply	C-suffix	2.5	16	V
		I-suffix	2.7	16	
	Split supply	C-suffix	±1.25	±8	
		I-suffix	±1.35	±8	
Common-mode input voltage, V_{ICR}			–0.1	$V_{CC} + 5$	V
Operating free-air temperature, T_A	C-suffix		0	70	°C
	I-suffix		–40	125	

7.3 Thermal Information – TLV3701

THERMAL METRIC ⁽¹⁾		TLV3701			UNIT
		DBV (SOT-23)	D (SOIC)	P (PDIP)	
		5 PINS	8 PINS		
$R_{\theta JA}$	Junction-to-ambient thermal resistance	193.6	124.8	82.8	°C/W
$R_{\theta JC(top)}$	Junction-to-case (top) thermal resistance	102.4	69.1	84.8	°C/W
$R_{\theta JB}$	Junction-to-board thermal resistance	54.3	67.9	59.7	°C/W
Ψ_{JT}	Junction-to-top characterization parameter	16.9	22.3	45.3	°C/W
Ψ_{JB}	Junction-to-board characterization parameter	53.6	67.2	59.5	°C/W
$R_{\theta JC(bot)}$	Junction-to-case (bottom) thermal resistance	—	—	—	°C/W

(1) For more information about traditional and new thermal metrics, see the [Semiconductor and IC Package Thermal Metrics](#) application report.

7.4 Thermal Information – TLV3702

THERMAL METRIC ⁽¹⁾		TLV3702			UNIT
		D (SOIC)	DGK (VSSOP)	P (PDIP)	
		8 PINS			
$R_{\theta JA}$	Junction-to-ambient thermal resistance	116.7	163.9	77.1	°C/W
$R_{\theta JC(top)}$	Junction-to-case (top) thermal resistance	59.4	65.7	79	°C/W
$R_{\theta JB}$	Junction-to-board thermal resistance	60.2	85.3	54	°C/W
Ψ_{JT}	Junction-to-top characterization parameter	14.6	9	39.5	°C/W
Ψ_{JB}	Junction-to-board characterization parameter	59.5	83.9	53.7	°C/W
$R_{\theta JC(bot)}$	Junction-to-case (bottom) thermal resistance	—	—	—	°C/W

(1) For more information about traditional and new thermal metrics, see the [Semiconductor and IC Package Thermal Metrics](#) application report.

7.5 Thermal Information – TLV3704

THERMAL METRIC ⁽¹⁾		TLV3704			UNIT
		D (SOIC)	N (PDIP)	PW (TSSOP)	
		14 PINS			
$R_{\theta JA}$	Junction-to-ambient thermal resistance	81.4	58.1	105.7	°C/W
$R_{\theta JC(top)}$	Junction-to-case (top) thermal resistance	38.1	50.9	33.9	°C/W
$R_{\theta JB}$	Junction-to-board thermal resistance	37.8	38	49.5	°C/W
Ψ_{JT}	Junction-to-top characterization parameter	7.5	23.6	2.5	°C/W
Ψ_{JB}	Junction-to-board characterization parameter	37.4	37.7	48.8	°C/W
$R_{\theta JC(bot)}$	Junction-to-case (bottom) thermal resistance	—	—	—	°C/W

(1) For more information about traditional and new thermal metrics, see the [Semiconductor and IC Package Thermal Metrics](#) application report.

7.6 Electrical Characteristics

At specified operating free-air temperature range, $V_{CC} = 2.7\text{ V}, 5\text{ V}, 15\text{ V}$ (unless otherwise noted).

PARAMETER		TEST CONDITIONS	$T_A^{(1)}$	MIN	TYP	MAX	UNIT
DC PERFORMANCE							
V_{IO}	Input offset voltage	$V_{IC} = V_{CC}/2, R_S = 50\ \Omega$	25°C	250	5000		μV
			Full range		7000		
α_{VIO}	Offset voltage drift	$V_{IC} = V_{CC}/2, R_S = 50\ \Omega$	25°C		3		$\mu\text{V}/^\circ\text{C}$
CMRR	Common-mode rejection ratio	$V_{IC} = 0\text{ to }2.7\text{ V}, R_S = 50\ \Omega$	25°C	55	72		dB
			Full range		50		
		$V_{IC} = 0\text{ to }5\text{ V}, R_S = 50\ \Omega$	25°C	60	76		
			Full range		55		
		$V_{IC} = 0\text{ to }15\text{ V}, R_S = 50\ \Omega$	25°C	65	88		
			Full range		60		
A_{VD}	Large-signal differential voltage amplification		25°C		1000		V/mV
INPUT/OUTPUT CHARACTERISTICS							
I_{IO}	Input offset current	$V_{IC} = V_{CC}/2, R_S = 50\ \Omega$	25°C	20	100		pA
			Full range		1000		
I_{IB}	Input bias current	$V_{IC} = V_{CC}/2, R_S = 50\ \Omega$	25°C	80	250		pA
			Full range		1500		
$r_{i(d)}$	Differential input resistance		25°C	300			M Ω
V_{OH}	High-level output voltage	$V_{IC} = V_{CC}/2, I_{OH} = 2\ \mu\text{A}, V_{ID} = 1\text{ V}$	25°C	$V_{CC} - 80$			mV
			Full range	$V_{CC} - 320$			
		$V_{IC} = V_{CC}/2, I_{OH} = -50\ \mu\text{A}, V_{ID} = 1\text{ V}$	Full range	$V_{CC} - 450$			
V_{OL}	Low-level output voltage	$V_{IC} = V_{CC}/2, I_{OH} = 2\ \mu\text{A}, V_{ID} = -1\text{ V}$	25°C	8			mV
			Full range	80		200	
		$V_{IC} = V_{CC}/2, I_{OH} = 50\ \mu\text{A}, V_{ID} = -1\text{ V}$	Full range	300			
POWER SUPPLY							
I_{CC}	Supply current (per channel)	Output state high	25°C	560	800		nA
			Full range		1000		
PSRR	Power supply rejection ratio	$V_{IC} = V_{CC}/2\text{ V}, \text{ No load}$	$V_{CC} = 2.7\text{ V to }5\text{ V}$	25°C	75	100	dB
				Full range		70	
			$V_{CC} = 5\text{ V to }15\text{ V}$	25°C	85	105	
				Full range		80	

(1) Full range is 0°C to 70°C for C suffix and -40°C to 125°C for I suffix. If not specified, full range is -40°C to 125°C.

7.7 Switching Characteristics

At specified operating free-air temperature range, $V_{CC} = 2.7\text{ V}, 5\text{ V}, 15\text{ V}$ (unless otherwise noted).

PARAMETER		TEST CONDITIONS		MIN	TYP	MAX	UNIT
$t_{(PLH)}$	Propagation response time, low-to-high-level output ⁽¹⁾	$f = 10\text{ kHz}, V_{STEP} = 100\text{ mV}, C_L = 10\text{ pF}, V_{CC} = 2.7\text{ V}$	Overdrive = 2 mV		240		μs
			Overdrive = 10 mV		64		
			Overdrive = 50 mV		36		
$t_{(PHL)}$	Propagation response time, high-to-low-level output ⁽¹⁾	$f = 10\text{ kHz}, V_{STEP} = 100\text{ mV}, C_L = 10\text{ pF}, V_{CC} = 2.7\text{ V}$	Overdrive = 2 mV		167		μs
			Overdrive = 10 mV		67		
			Overdrive = 50 mV		37		
t_r	Rise time	$C_L = 10\text{ pF}, V_{CC} = 2.7\text{ V}$			7		μs
t_f	Fall time	$C_L = 10\text{ pF}, V_{CC} = 2.7\text{ V}$			9		μs
t_{su}	Start-up time (TLV3701 Only)	$V_{CC} = 2.7\text{ to }15\text{V}^{(2)}$	25°C		7	15	ms
			Full range		14	30	

- (1) The response time specified is the interval between the input step function and the instant when the output crosses 1.4 V. Propagation responses are longer at higher supply voltages, refer to **Figures 12 – 17** for further details.
- (2) The definition of start-up time is the time period between the supply voltage reaching minimum supply (V_{CCmin}) and the device IQ activating (I_{CCmin}) with a valid device output voltage. Single device only.

7.8 Dissipation Ratings

PACKAGE	θ_{JC} (°C/W)	θ_{JA} (°C/W)	$T_A \leq 25^\circ\text{C}$ POWER RATING	$T_A = 125^\circ\text{C}$ POWER RATING
D (8)	69.1	124.8	1001 mW	200 mW
D (14)	38.1	81.4	1536 mW	307 mW
DBV (5)	102.4	193.6	646 mW	129 mW
DGK (8)	65.7	163.9	763 mW	153 mW
N (14)	50.9	58.1	2151 mW	430 mW
P (8)	84.8	82.8	1510 mW	302 mW
PW (14)	33.9	105.7	1183 mW	237 mW

7.9 Typical Characteristics

At specified operating conditions (unless otherwise noted).

Table 5. Table of Graphs

		FIGURE
Input bias/offset current	vs Free-air temperature	Figure 2
V_{OL}	Low-level output voltage	Figure 6, Figure 8, Figure 4
V_{OH}	High-level output voltage	Figure 3, Figure 5, Figure 7
I_{CC}	Supply current	vs Supply voltage
		Free-air temperature
Output fall time/rise time	vs Supply voltage	Figure 10
Low-to-high level output response for various input overdrives		Figure 11, Figure 13, Figure 15
High-to-low level output response for various input overdrives		Figure 12, Figure 14, Figure 16

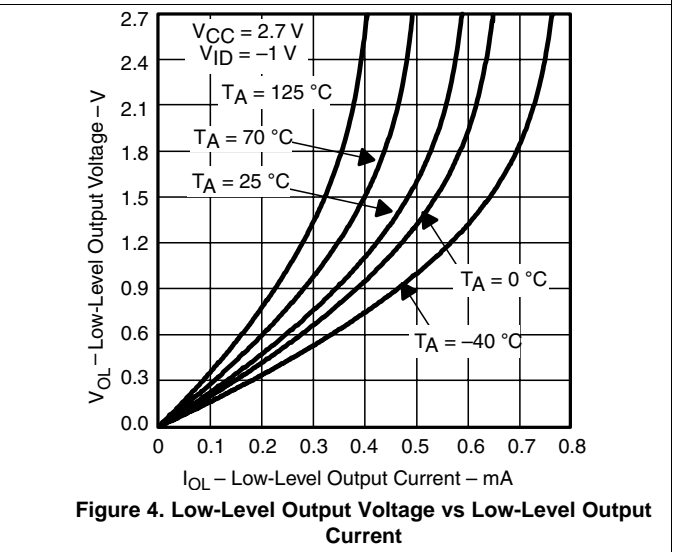
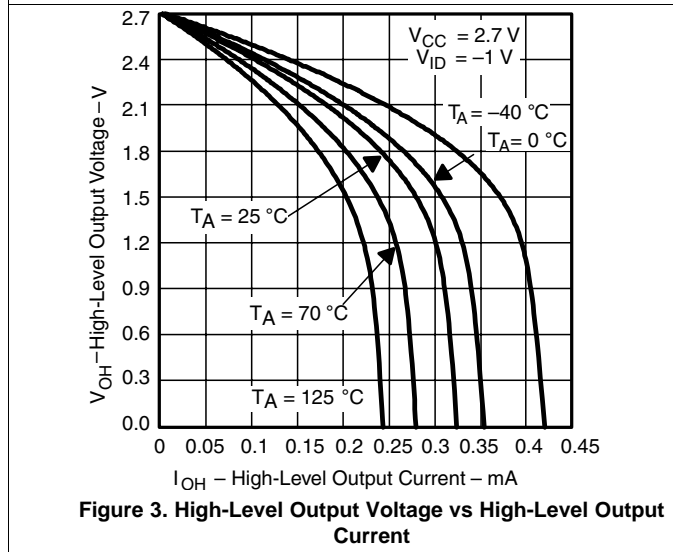
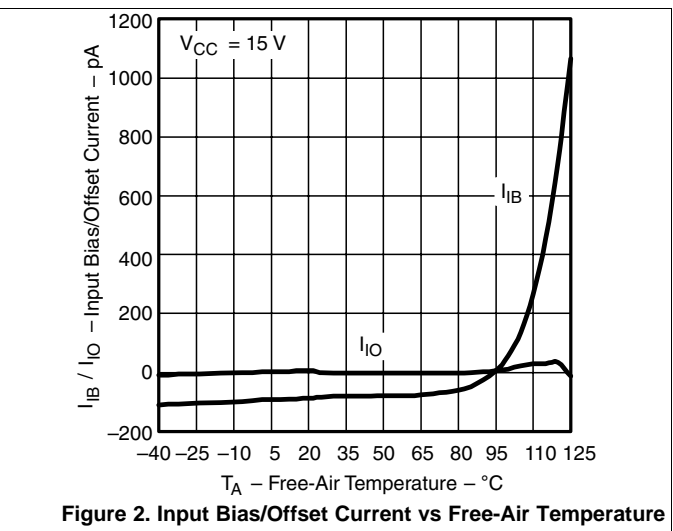
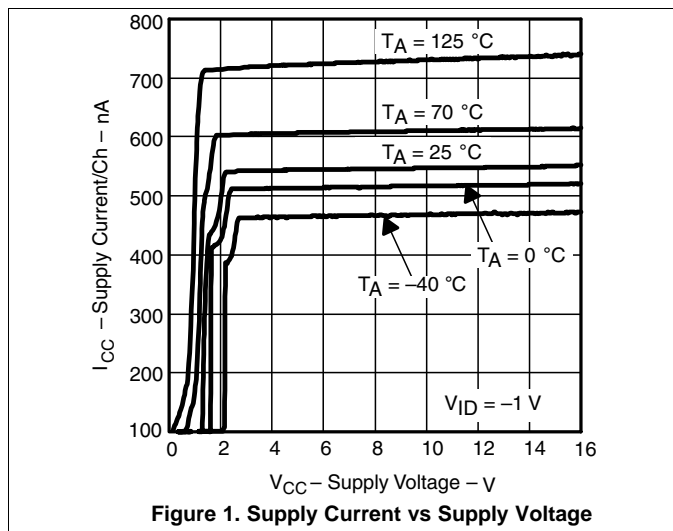

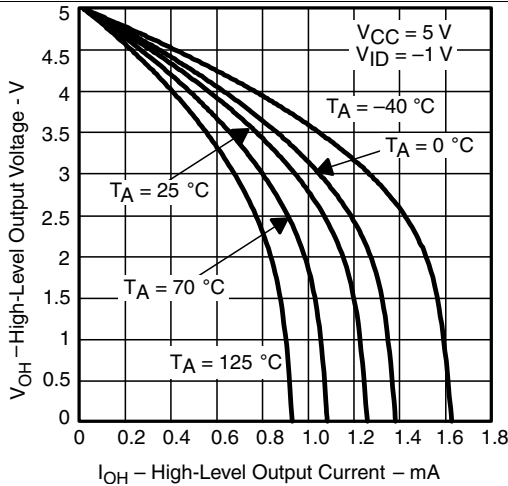

Figure 5. High-Level Output Voltage vs High-Level Output Current

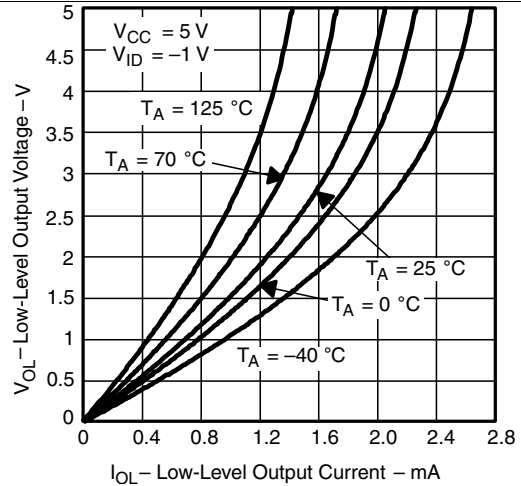

Figure 6. Low-Level Output Voltage vs Low-Level Output Current



Figure 7. High-Level Output Voltage vs High-Level Output Current



Figure 8. Low-Level Output Voltage vs Low-Level Output Current

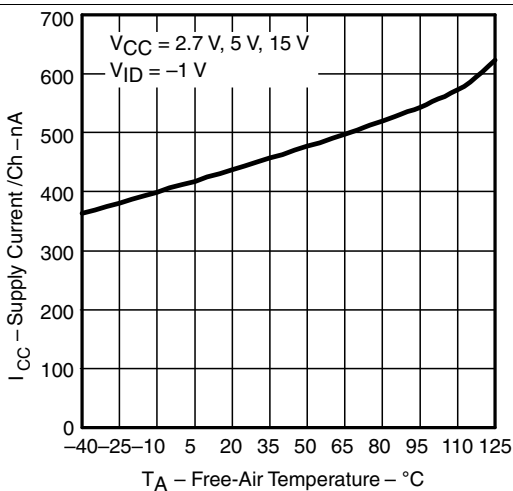

Figure 9. Supply Current vs Free-Air Temperature

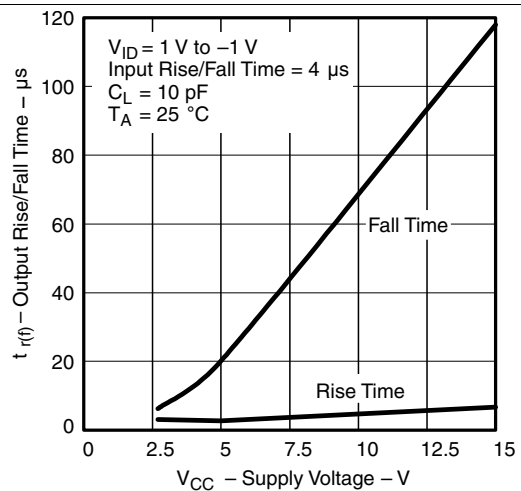
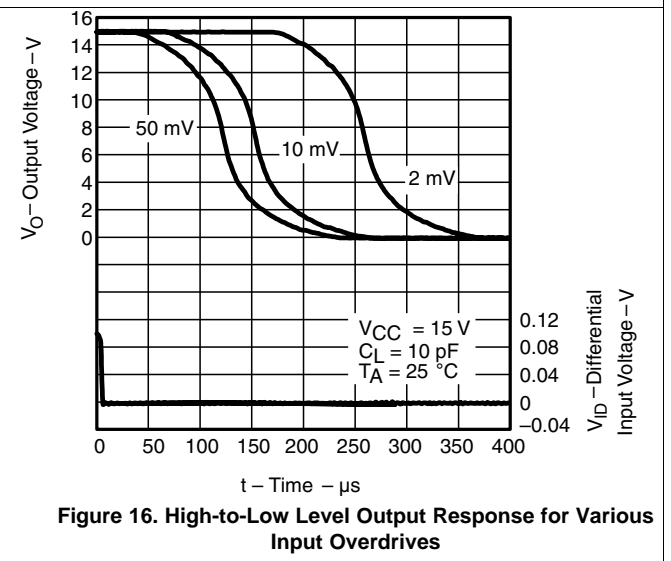
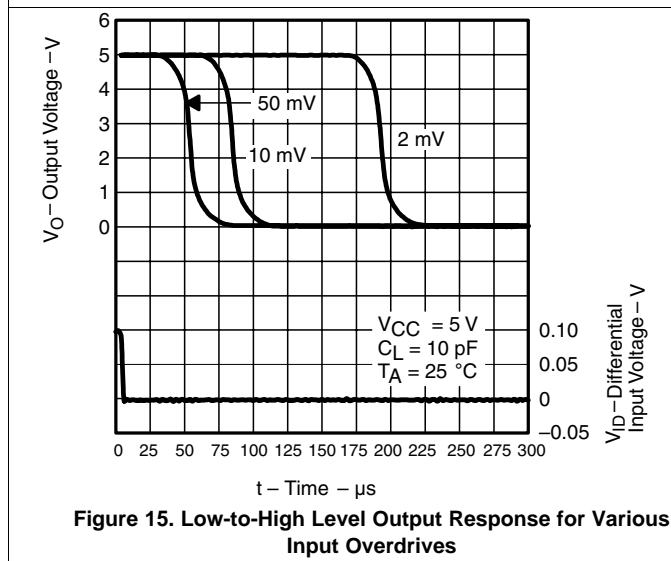
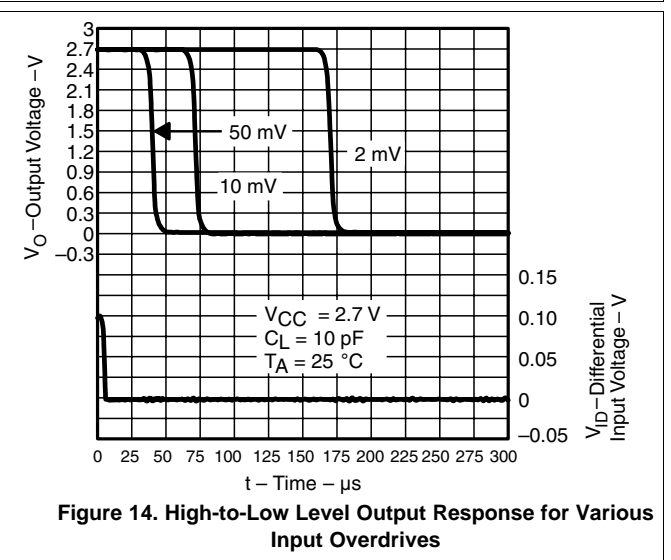
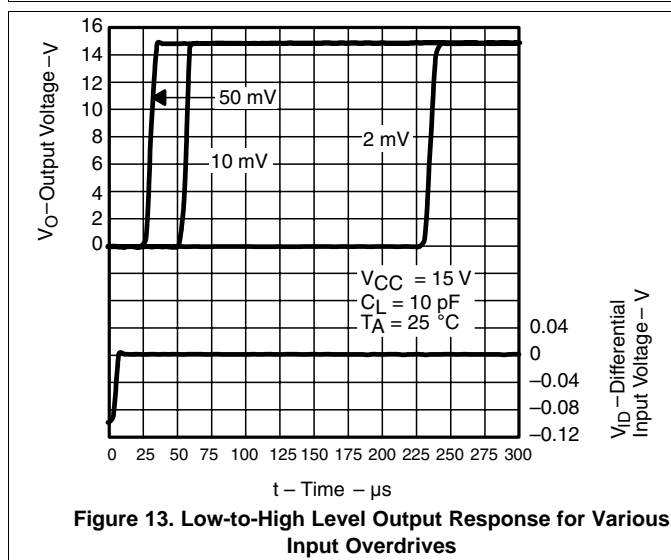
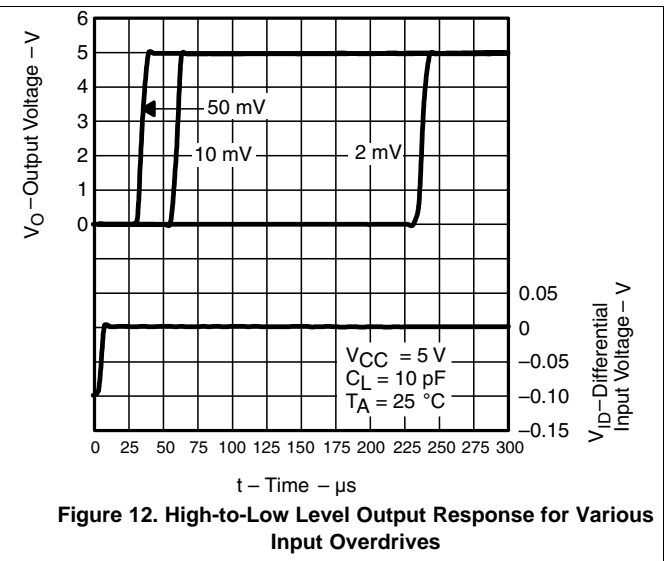

Figure 10. Output Rise/Fall Time vs Supply Voltage



8 Detailed Description

8.1 Overview

The TLV370x is a family of nanopower comparators drawing only 560 nA per channel supply current. Having a minimum operating supply voltage of 2.7 V over the extended industrial temperature range ($T_A = -40^{\circ}\text{C}$ to $+125^{\circ}\text{C}$), while having an input common-mode range of -0.1 to $V_{CC} + 5$ V makes this device ideal for battery-powered and wireless handset applications.

8.2 Functional Block Diagram

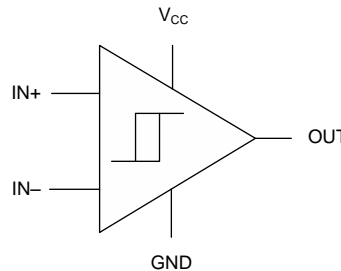

Copyright © 2016, Texas Instruments Incorporated

8.3 Feature Description

8.3.1 Operating Voltage

The TLV340x comparators are specified for use on a single supply from 2.5 V to 16 V (or a dual supply from ± 1.25 V to ± 16 V) over a temperature range of -40°C to $+125^{\circ}\text{C}$.

8.3.2 Setting the Threshold

Using a low-power, stable reference is important when setting the transition point for the TLV340x devices. The REF3312, as shown in Figure 17, provides a 1.25-V reference voltage with low drift and only 3.9 μA of quiescent current.

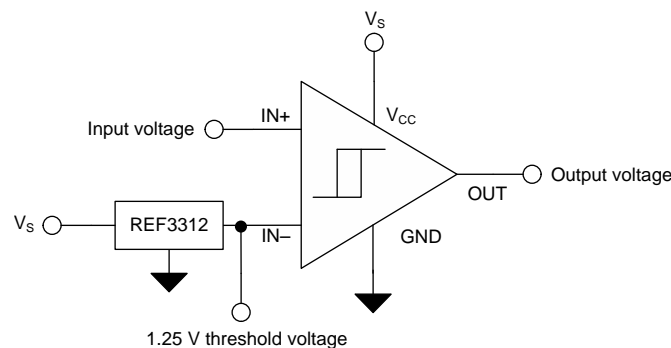

Copyright © 2016, Texas Instruments Incorporated

Figure 17. Setting the Threshold

8.4 Device Functional Modes

The TLV370x has a single functional mode and is operational when the power supply voltage applied ranges from 2.5 V (± 1.25 V) to 16 V (± 8 V).

9 Application and Implementation

NOTE

Information in the following applications sections is not part of the TI component specification, and TI does not warrant its accuracy or completeness. TI's customers are responsible for determining suitability of components for their purposes. Customers should validate and test their design implementation to confirm system functionality.

9.1 Application Information

Many applications require the detection of a signal (voltage or current) that exceeds a particular threshold voltage or current. Using a comparator to make that threshold detection is the easiest, lowest power and highest speed way to make a threshold detection.

9.2 Typical Application

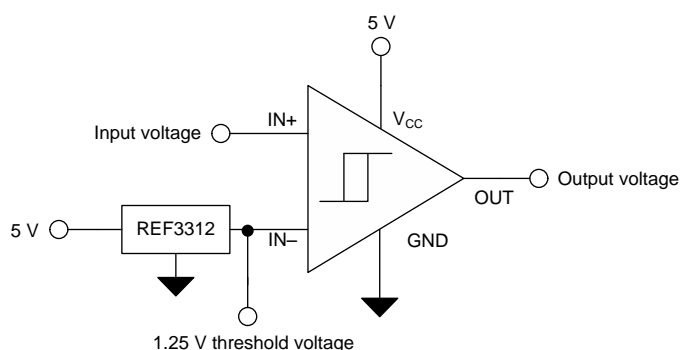

Copyright © 2016, Texas Instruments Incorporated

Figure 18. 1.25-V Threshold Detector

9.2.1 Design Requirements

- Detect when a signal is above or below 1.25 V
- Operate from a single 5-V power supply
- Rail-to-rail input voltage range from 0 to 5 V
- Rail-to-rail output voltage range from 0 to 5 V

9.2.2 Detailed Design Procedure

The input voltage range in the circuit illustrated in [Figure 18](#) is limited only by the power supply applied to the TV3701. In this example with the selection of a 5-V, single-supply power supply, the input voltage range is limited to 0 to $V_S + 5$ V, or 0 to 10 V. The threshold voltage of 1.25 V can be derived in a variety of ways. As the TLV3701 is a very low-power device, it is desirable to also use very low power to create the threshold voltage. The REF3312 series voltage reference is selected for its stable output voltage of 1.25 V and its low power consumption of only 3.9 μ A. The TLV3701 is a push-pull output comparator, and does not require a pullup resistor to save power.

Typical Application (continued)

9.2.3 Application Curve

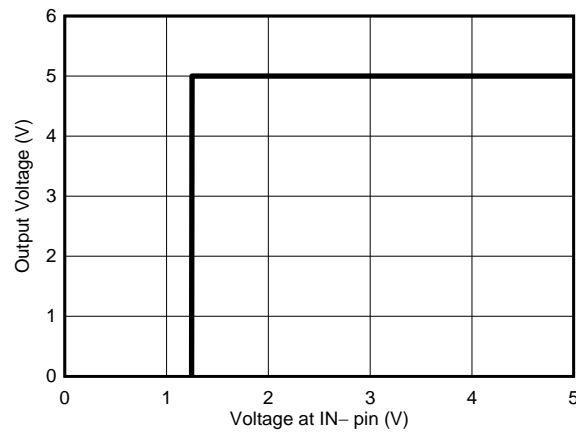

Figure 19. Transfer Function for the Threshold Detector

10 Power Supply Recommendations

The TLV340x device is specified for operation from 2.5 V to 16 V (± 1.25 to ± 8 V); many specifications apply from -40°C to $+125^{\circ}\text{C}$. Parameters that can exhibit significant variance with regard to operating voltage or temperature are presented in [Typical Characteristics](#).

11 Layout

11.1 Layout Guidelines

Figure 20 shows the typical connections for the TLV340x. To minimize supply noise, power supplies must be capacitively decoupled by a 0.01- μF ceramic capacitor in parallel with a 10- μF electrolytic capacitor. Comparators are very sensitive to input noise. Proper grounding (the use of a ground plane) helps to maintain the specified performance of the TLV340x family.

For best results, maintain the following layout guidelines:

1. Use a printed-circuit board (PCB) with a good, unbroken low-inductance ground plane.
2. Place a decoupling capacitor (0.1- μF ceramic, surface-mount capacitor) as close as possible to V_{CC} .
3. On the inputs and the output, keep lead lengths as short as possible to avoid unwanted parasitic feedback around the comparator. Keep inputs away from the output.
4. Solder the device directly to the PCB rather than using a socket.
5. For slow-moving input signals, take care to prevent parasitic feedback. A small capacitor (1000 pF or less) placed between the inputs can help eliminate oscillations in the transition region. This capacitor causes some degradation to propagation delay when the impedance is low. The top-side ground plane runs between the output and inputs.
6. The ground pin ground trace runs under the device up to the bypass capacitor, shielding the inputs from the outputs.

11.2 Layout Example



Copyright © 2016, Texas Instruments Incorporated

Figure 20. TLV3701 SOT-23 Layout Example

12 Device and Documentation Support

12.1 Device Support

12.1.1 Development Support

12.1.1.1 DIP Adapter EVM

The [DIP Adapter EVM](#) tool provides an easy, low-cost way to prototype small surface mount ICs. The evaluation tool these TI packages: D or U (8-pin SOIC), PW (8-pin TSSOP), DGK (8-pin MSOP), DBV (6-pin SOT-23, 5-pin SOT23, and 3-pin SOT-23), DCK (6-pin SC-70 and 5-pin SC-70), and DRL (6-pin SOT-563). The DIP Adapter EVM may also be used with terminal strips or may be wired directly to existing circuits.

12.1.1.2 Universal Op Amp EVM

The [Universal Op Amp EVM](#) is a series of general-purpose, blank circuit boards that simplify prototyping circuits for a variety of IC package types. The evaluation module board design allows many different circuits to be constructed easily and quickly. Five models are offered, with each model intended for a specific package type. PDIP, SOIC, MSOP, TSSOP, and SOT-23 packages are all supported.

NOTE

These boards are unpopulated, so users must provide their own ICs. TI recommends requesting several op amp device samples when ordering the Universal Op Amp EVM.

12.2 Documentation Support

12.2.1 Related Documentation

The following documents are relevant for using the TLV340x devices and are recommended for reference. All are available for download at www.ti.com (unless otherwise noted):

- [Universal Op Amp EVM User Guide](#) (SLOU060)
- [Hardware Pace Using Slope Detection](#) (SLAU511)
- [Bipolar High-voltage Differential Interface for Low-Voltage Comparators](#) (TIDU039)
- [AC-Coupled Single Supply Comparator](#) (SLAU505)
- [ECG Implementation on the TMS320VC5505 DSP Medical Development Kit](#) (SPRAB36)
- [REF33xx 3.9- \$\mu\$ A, SC70-3, SOT-23-3, and UQFN-8, 30-ppm/ \$^{\circ}\$ C Drift Voltage Reference](#) (SBOS392)

12.3 Related Links

The table below lists quick access links. Categories include technical documents, support and community resources, tools and software, and quick access to sample or buy.

Table 6. Related Links

PARTS	PRODUCT FOLDER	SAMPLE & BUY	TECHNICAL DOCUMENTS	TOOLS & SOFTWARE	SUPPORT & COMMUNITY
TLV3701	Click here	Click here	Click here	Click here	Click here
TLV3702	Click here	Click here	Click here	Click here	Click here
TLV3704	Click here	Click here	Click here	Click here	Click here

12.4 Receiving Notification of Documentation Updates

To receive notification of documentation updates, navigate to the device product folder on ti.com. In the upper right corner, click on *Alert me* to register and receive a weekly digest of any product information that has changed. For change details, review the revision history included in any revised document.

12.5 Community Resources

The following links connect to TI community resources. Linked contents are provided "AS IS" by the respective contributors. They do not constitute TI specifications and do not necessarily reflect TI's views; see TI's [Terms of Use](#).

TI E2E™ Online Community *TI's Engineer-to-Engineer (E2E) Community*. Created to foster collaboration among engineers. At e2e.ti.com, you can ask questions, share knowledge, explore ideas and help solve problems with fellow engineers.

Design Support *TI's Design Support* Quickly find helpful E2E forums along with design support tools and contact information for technical support.

12.6 Trademarks

E2E is a trademark of Texas Instruments.
All other trademarks are the property of their respective owners.

12.7 Electrostatic Discharge Caution



This integrated circuit can be damaged by ESD. Texas Instruments recommends that all integrated circuits be handled with appropriate precautions. Failure to observe proper handling and installation procedures can cause damage.

ESD damage can range from subtle performance degradation to complete device failure. Precision integrated circuits may be more susceptible to damage because very small parametric changes could cause the device not to meet its published specifications.

12.8 Glossary

[SLYZ022](#) — *TI Glossary*.

This glossary lists and explains terms, acronyms, and definitions.

13 Mechanical, Packaging, and Orderable Information

The following pages include mechanical, packaging, and orderable information. This information is the most current data available for the designated devices. This data is subject to change without notice and revision of this document. For browser-based versions of this data sheet, refer to the left-hand navigation.

PACKAGING INFORMATION

Orderable Device	Status (1)	Package Type	Package Drawing	Pins	Package Qty	Eco Plan (2)	Lead finish/ Ball material (6)	MSL Peak Temp (3)	Op Temp (°C)	Device Marking (4/5)	Samples
TLV3701CD	ACTIVE	SOIC	D	8	75	RoHS & Green	NIPDAU	Level-1-260C-UNLIM	0 to 70	3701C	Samples
TLV3701CDBVR	ACTIVE	SOT-23	DBV	5	3000	RoHS & Green	NIPDAU	Level-1-260C-UNLIM	0 to 70	VBCC	Samples
TLV3701CDBVT	ACTIVE	SOT-23	DBV	5	250	RoHS & Green	NIPDAU	Level-1-260C-UNLIM	0 to 70	VBCC	Samples
TLV3701CDBVTG4	ACTIVE	SOT-23	DBV	5	250	RoHS & Green	NIPDAU	Level-1-260C-UNLIM	0 to 70	VBCC	Samples
TLV3701ID	ACTIVE	SOIC	D	8	75	RoHS & Green	NIPDAU	Level-1-260C-UNLIM	-40 to 125	3701I	Samples
TLV3701IDBVR	ACTIVE	SOT-23	DBV	5	3000	RoHS & Green	NIPDAU	Level-1-260C-UNLIM	-40 to 125	VBCI	Samples
TLV3701IDBVRG4	ACTIVE	SOT-23	DBV	5	3000	RoHS & Green	NIPDAU	Level-1-260C-UNLIM	-40 to 125	VBCI	Samples
TLV3701IDBVT	ACTIVE	SOT-23	DBV	5	250	RoHS & Green	NIPDAU	Level-1-260C-UNLIM	-40 to 125	VBCI	Samples
TLV3701IDBVTG4	ACTIVE	SOT-23	DBV	5	250	RoHS & Green	NIPDAU	Level-1-260C-UNLIM	-40 to 125	VBCI	Samples
TLV3701IDR	ACTIVE	SOIC	D	8	2500	RoHS & Green	NIPDAU	Level-1-260C-UNLIM	-40 to 125	3701I	Samples
TLV3701IP	ACTIVE	PDIP	P	8	50	RoHS & Green	NIPDAU	N / A for Pkg Type	-40 to 125	TLV3701I	Samples
TLV3702CD	ACTIVE	SOIC	D	8	75	RoHS & Green	NIPDAU	Level-1-260C-UNLIM	0 to 70	3702C	Samples
TLV3702CDGK	ACTIVE	VSSOP	DGK	8	80	RoHS & Green	NIPDAU	Level-1-260C-UNLIM	0 to 70	AKC	Samples
TLV3702CDGKR	ACTIVE	VSSOP	DGK	8	2500	RoHS & Green	NIPDAU	Level-1-260C-UNLIM	0 to 70	AKC	Samples
TLV3702ID	ACTIVE	SOIC	D	8	75	RoHS & Green	NIPDAU	Level-1-260C-UNLIM	-40 to 125	3702I	Samples
TLV3702IDGK	ACTIVE	VSSOP	DGK	8	80	RoHS & Green	NIPDAU	Level-1-260C-UNLIM	-40 to 125	AKD	Samples
TLV3702IDGKG4	ACTIVE	VSSOP	DGK	8	80	RoHS & Green	NIPDAU	Level-1-260C-UNLIM	-40 to 125	AKD	Samples
TLV3702IDGKR	ACTIVE	VSSOP	DGK	8	2500	RoHS & Green	NIPDAU	Level-1-260C-UNLIM	-40 to 125	AKD	Samples
TLV3702IDGKRG4	ACTIVE	VSSOP	DGK	8	2500	RoHS & Green	NIPDAU	Level-1-260C-UNLIM	-40 to 125	AKD	Samples
TLV3702IDR	ACTIVE	SOIC	D	8	2500	RoHS & Green	NIPDAU	Level-1-260C-UNLIM	-40 to 125	3702I	Samples

Orderable Device	Status (1)	Package Type	Package Drawing	Pins	Package Qty	Eco Plan (2)	Lead finish/ Ball material (6)	MSL Peak Temp (3)	Op Temp (°C)	Device Marking (4/5)	Samples
TLV3702IP	ACTIVE	PDIP	P	8	50	RoHS & Green	NIPDAU	N / A for Pkg Type	-40 to 125	TLV3702I	Samples
TLV3704CD	ACTIVE	SOIC	D	14	50	RoHS & Green	NIPDAU	Level-1-260C-UNLIM	0 to 70	3704C	Samples
TLV3704CPW	ACTIVE	TSSOP	PW	14	90	RoHS & Green	NIPDAU	Level-1-260C-UNLIM	0 to 70	3704C	Samples
TLV3704ID	ACTIVE	SOIC	D	14	50	RoHS & Green	NIPDAU	Level-1-260C-UNLIM	-40 to 125	3704I	Samples
TLV3704IDR	ACTIVE	SOIC	D	14	2500	RoHS & Green	NIPDAU	Level-1-260C-UNLIM	-40 to 125	3704I	Samples
TLV3704IN	ACTIVE	PDIP	N	14	25	RoHS & Green	NIPDAU	N / A for Pkg Type	-40 to 125	TLV3704I	Samples
TLV3704IPW	ACTIVE	TSSOP	PW	14	90	RoHS & Green	NIPDAU	Level-1-260C-UNLIM	-40 to 125	3704I	Samples
TLV3704IPWR	ACTIVE	TSSOP	PW	14	2000	RoHS & Green	NIPDAU	Level-1-260C-UNLIM	-40 to 125	3704I	Samples

(1) The marketing status values are defined as follows:

ACTIVE: Product device recommended for new designs.

LIFEBUY: TI has announced that the device will be discontinued, and a lifetime-buy period is in effect.

NRND: Not recommended for new designs. Device is in production to support existing customers, but TI does not recommend using this part in a new design.

PREVIEW: Device has been announced but is not in production. Samples may or may not be available.

OBSOLETE: TI has discontinued the production of the device.

(2) **RoHS:** TI defines "RoHS" to mean semiconductor products that are compliant with the current EU RoHS requirements for all 10 RoHS substances, including the requirement that RoHS substance do not exceed 0.1% by weight in homogeneous materials. Where designed to be soldered at high temperatures, "RoHS" products are suitable for use in specified lead-free processes. TI may reference these types of products as "Pb-Free".

RoHS Exempt: TI defines "RoHS Exempt" to mean products that contain lead but are compliant with EU RoHS pursuant to a specific EU RoHS exemption.

Green: TI defines "Green" to mean the content of Chlorine (Cl) and Bromine (Br) based flame retardants meet JS709B low halogen requirements of <=1000ppm threshold. Antimony trioxide based flame retardants must also meet the <=1000ppm threshold requirement.

(3) MSL, Peak Temp. - The Moisture Sensitivity Level rating according to the JEDEC industry standard classifications, and peak solder temperature.

(4) There may be additional marking, which relates to the logo, the lot trace code information, or the environmental category on the device.

(5) Multiple Device Markings will be inside parentheses. Only one Device Marking contained in parentheses and separated by a "~" will appear on a device. If a line is indented then it is a continuation of the previous line and the two combined represent the entire Device Marking for that device.

(6) Lead finish/Ball material - Orderable Devices may have multiple material finish options. Finish options are separated by a vertical ruled line. Lead finish/Ball material values may wrap to two lines if the finish value exceeds the maximum column width.

Important Information and Disclaimer:The information provided on this page represents TI's knowledge and belief as of the date that it is provided. TI bases its knowledge and belief on information provided by third parties, and makes no representation or warranty as to the accuracy of such information. Efforts are underway to better integrate information from third parties. TI has taken and continues to take reasonable steps to provide representative and accurate information but may not have conducted destructive testing or chemical analysis on incoming materials and chemicals. TI and TI suppliers consider certain information to be proprietary, and thus CAS numbers and other limited information may not be available for release.

In no event shall TI's liability arising out of such information exceed the total purchase price of the TI part(s) at issue in this document sold by TI to Customer on an annual basis.

OTHER QUALIFIED VERSIONS OF TLV3701, TLV3702 :

- Automotive : [TLV3701-Q1](#), [TLV3702-Q1](#)
- Enhanced Product : [TLV3701-EP](#)

NOTE: Qualified Version Definitions:

- Automotive - Q100 devices qualified for high-reliability automotive applications targeting zero defects
- Enhanced Product - Supports Defense, Aerospace and Medical Applications

TAPE AND REEL INFORMATION

QUADRANT ASSIGNMENTS FOR PIN 1 ORIENTATION IN TAPE

*All dimensions are nominal

Device	Package Type	Package Drawing	Pins	SPQ	Reel Diameter (mm)	Reel Width W1 (mm)	A0 (mm)	B0 (mm)	K0 (mm)	P1 (mm)	W (mm)	Pin1 Quadrant
TLV3701CDBVR	SOT-23	DBV	5	3000	180.0	9.0	3.15	3.2	1.4	4.0	8.0	Q3
TLV3701CDBVT	SOT-23	DBV	5	250	180.0	9.0	3.15	3.2	1.4	4.0	8.0	Q3
TLV3701IDBVR	SOT-23	DBV	5	3000	180.0	9.0	3.15	3.2	1.4	4.0	8.0	Q3
TLV3701IDBVT	SOT-23	DBV	5	250	180.0	9.0	3.15	3.2	1.4	4.0	8.0	Q3
TLV3701IDR	SOIC	D	8	2500	330.0	12.4	6.4	5.2	2.1	8.0	12.0	Q1
TLV3702CDGKR	VSSOP	DGK	8	2500	330.0	12.4	5.3	3.4	1.4	8.0	12.0	Q1
TLV3702IDGKR	VSSOP	DGK	8	2500	330.0	12.4	5.3	3.4	1.4	8.0	12.0	Q1
TLV3702IDR	SOIC	D	8	2500	330.0	12.4	6.4	5.2	2.1	8.0	12.0	Q1
TLV3704IDR	SOIC	D	14	2500	330.0	16.4	6.5	9.0	2.1	8.0	16.0	Q1
TLV3704IPWR	TSSOP	PW	14	2000	330.0	12.4	6.9	5.6	1.6	8.0	12.0	Q1

TAPE AND REEL BOX DIMENSIONS

*All dimensions are nominal

Device	Package Type	Package Drawing	Pins	SPQ	Length (mm)	Width (mm)	Height (mm)
TLV3701CDBVR	SOT-23	DBV	5	3000	182.0	182.0	20.0
TLV3701CDBVT	SOT-23	DBV	5	250	182.0	182.0	20.0
TLV3701IDBVR	SOT-23	DBV	5	3000	182.0	182.0	20.0
TLV3701IDBVT	SOT-23	DBV	5	250	182.0	182.0	20.0
TLV3701IDR	SOIC	D	8	2500	340.5	336.1	25.0
TLV3702CDGKR	VSSOP	DGK	8	2500	358.0	335.0	35.0
TLV3702IDGKR	VSSOP	DGK	8	2500	358.0	335.0	35.0
TLV3702IDR	SOIC	D	8	2500	340.5	336.1	25.0
TLV3704IDR	SOIC	D	14	2500	340.5	336.1	32.0
TLV3704IPWR	TSSOP	PW	14	2000	356.0	356.0	35.0

TUBE

*All dimensions are nominal

Device	Package Name	Package Type	Pins	SPQ	L (mm)	W (mm)	T (μm)	B (mm)
TLV3701CD	D	SOIC	8	75	507	8	3940	4.32
TLV3701ID	D	SOIC	8	75	507	8	3940	4.32
TLV3701IP	P	PDIP	8	50	506	13.97	11230	4.32
TLV3702CD	D	SOIC	8	75	507	8	3940	4.32
TLV3702ID	D	SOIC	8	75	507	8	3940	4.32
TLV3702IP	P	PDIP	8	50	506	13.97	11230	4.32
TLV3704CD	D	SOIC	14	50	507	8	3940	4.32
TLV3704CPW	PW	TSSOP	14	90	530	10.2	3600	3.5
TLV3704ID	D	SOIC	14	50	507	8	3940	4.32
TLV3704IN	N	PDIP	14	25	506	13.97	11230	4.32
TLV3704IPW	PW	TSSOP	14	90	530	10.2	3600	3.5

D (R-PDSO-G14)

PLASTIC SMALL OUTLINE



- NOTES:
- A. All linear dimensions are in millimeters.
 - B. This drawing is subject to change without notice.
 - C. Publication IPC-7351 is recommended for alternate designs.
 - D. Laser cutting apertures with trapezoidal walls and also rounding corners will offer better paste release. Customers should contact their board assembly site for stencil design recommendations. Refer to IPC-7525 for other stencil recommendations.
 - E. Customers should contact their board fabrication site for solder mask tolerances between and around signal pads.

PW (R-PDSO-G14)

PLASTIC SMALL OUTLINE



- NOTES:
- A. All linear dimensions are in millimeters. Dimensioning and tolerancing per ASME Y14.5M-1994.
 - B. This drawing is subject to change without notice.
 - C. Body length does not include mold flash, protrusions, or gate burrs. Mold flash, protrusions, or gate burrs shall not exceed 0,15 each side.
 - D. Body width does not include interlead flash. Interlead flash shall not exceed 0,25 each side.
 - E. Falls within JEDEC MO-153

PW (R-PDSO-G14)

PLASTIC SMALL OUTLINE

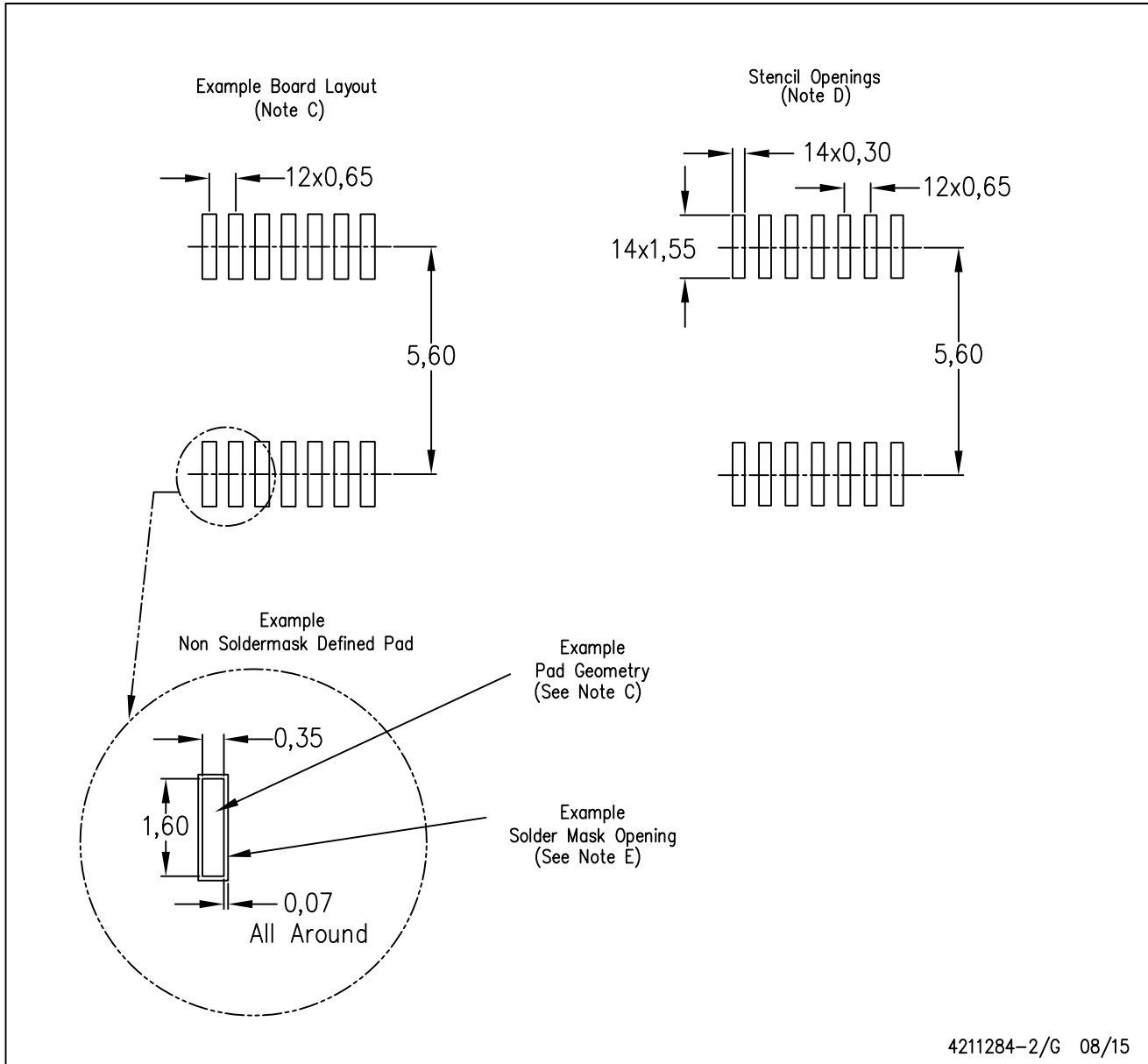

- NOTES:
- All linear dimensions are in millimeters.
 - This drawing is subject to change without notice.
 - Publication IPC-7351 is recommended for alternate designs.
 - Laser cutting apertures with trapezoidal walls and also rounding corners will offer better paste release. Customers should contact their board assembly site for stencil design recommendations. Refer to IPC-7525 for other stencil recommendations.
 - Customers should contact their board fabrication site for solder mask tolerances between and around signal pads.



D0008A

PACKAGE OUTLINE

SOIC - 1.75 mm max height

SMALL OUTLINE INTEGRATED CIRCUIT



4214825/C 02/2019

NOTES:

1. Linear dimensions are in inches [millimeters]. Dimensions in parenthesis are for reference only. Controlling dimensions are in inches. Dimensioning and tolerancing per ASME Y14.5M.
2. This drawing is subject to change without notice.
3. This dimension does not include mold flash, protrusions, or gate burrs. Mold flash, protrusions, or gate burrs shall not exceed .006 [0.15] per side.
4. This dimension does not include interlead flash.
5. Reference JEDEC registration MS-012, variation AA.

EXAMPLE BOARD LAYOUT

D0008A

SOIC - 1.75 mm max height

SMALL OUTLINE INTEGRATED CIRCUIT



LAND PATTERN EXAMPLE
EXPOSED METAL SHOWN
SCALE:8X



SOLDER MASK DETAILS

4214825/C 02/2019

NOTES: (continued)

6. Publication IPC-7351 may have alternate designs.

7. Solder mask tolerances between and around signal pads can vary based on board fabrication site.

EXAMPLE STENCIL DESIGN

D0008A

SOIC - 1.75 mm max height

SMALL OUTLINE INTEGRATED CIRCUIT



SOLDER PASTE EXAMPLE
BASED ON .005 INCH [0.125 MM] THICK STENCIL
SCALE:8X

4214825/C 02/2019

NOTES: (continued)

8. Laser cutting apertures with trapezoidal walls and rounded corners may offer better paste release. IPC-7525 may have alternate design recommendations.
9. Board assembly site may have different recommendations for stencil design.

P (R-PDIP-T8)

PLASTIC DUAL-IN-LINE PACKAGE



- NOTES:
- A. All linear dimensions are in inches (millimeters).
 - B. This drawing is subject to change without notice.
 - C. Falls within JEDEC MS-001 variation BA.

DGK (S-PDSO-G8)

PLASTIC SMALL-OUTLINE PACKAGE



- NOTES:
- A. All linear dimensions are in millimeters.
 - B. This drawing is subject to change without notice.
 - C. Body length does not include mold flash, protrusions, or gate burrs. Mold flash, protrusions, or gate burrs shall not exceed 0.15 per end.
 - D. Body width does not include interlead flash. Interlead flash shall not exceed 0.50 per side.
 - E. Falls within JEDEC MO-187 variation AA, except interlead flash.



- NOTES:
- A. All linear dimensions are in millimeters.
 - B. This drawing is subject to change without notice.
 - C. Publication IPC-7351 is recommended for alternate designs.
 - D. Laser cutting apertures with trapezoidal walls and also rounding corners will offer better paste release. Customers should contact their board assembly site for stencil design recommendations. Refer to IPC-7525 for other stencil recommendations.
 - E. Customers should contact their board fabrication site for solder mask tolerances between and around signal pads.

EXAMPLE BOARD LAYOUT

DBV0005A

SOT-23 - 1.45 mm max height

SMALL OUTLINE TRANSISTOR



LAND PATTERN EXAMPLE
EXPOSED METAL SHOWN
SCALE:15X



SOLDER MASK DETAILS

4214839/F 06/2021

NOTES: (continued)

- 5. Publication IPC-7351 may have alternate designs.
- 6. Solder mask tolerances between and around signal pads can vary based on board fabrication site.

EXAMPLE STENCIL DESIGN

DBV0005A

SOT-23 - 1.45 mm max height

SMALL OUTLINE TRANSISTOR



SOLDER PASTE EXAMPLE
BASED ON 0.125 mm THICK STENCIL
SCALE:15X

4214839/F 06/2021

NOTES: (continued)

7. Laser cutting apertures with trapezoidal walls and rounded corners may offer better paste release. IPC-7525 may have alternate design recommendations.
8. Board assembly site may have different recommendations for stencil design.

IMPORTANT NOTICE AND DISCLAIMER

TI PROVIDES TECHNICAL AND RELIABILITY DATA (INCLUDING DATA SHEETS), DESIGN RESOURCES (INCLUDING REFERENCE DESIGNS), APPLICATION OR OTHER DESIGN ADVICE, WEB TOOLS, SAFETY INFORMATION, AND OTHER RESOURCES "AS IS" AND WITH ALL FAULTS, AND DISCLAIMS ALL WARRANTIES, EXPRESS AND IMPLIED, INCLUDING WITHOUT LIMITATION ANY IMPLIED WARRANTIES OF MERCHANTABILITY, FITNESS FOR A PARTICULAR PURPOSE OR NON-INFRINGEMENT OF THIRD PARTY INTELLECTUAL PROPERTY RIGHTS.

These resources are intended for skilled developers designing with TI products. You are solely responsible for (1) selecting the appropriate TI products for your application, (2) designing, validating and testing your application, and (3) ensuring your application meets applicable standards, and any other safety, security, regulatory or other requirements.

These resources are subject to change without notice. TI grants you permission to use these resources only for development of an application that uses the TI products described in the resource. Other reproduction and display of these resources is prohibited. No license is granted to any other TI intellectual property right or to any third party intellectual property right. TI disclaims responsibility for, and you will fully indemnify TI and its representatives against, any claims, damages, costs, losses, and liabilities arising out of your use of these resources.

TI's products are provided subject to [TI's Terms of Sale](#) or other applicable terms available either on ti.com or provided in conjunction with such TI products. TI's provision of these resources does not expand or otherwise alter TI's applicable warranties or warranty disclaimers for TI products.

TI objects to and rejects any additional or different terms you may have proposed.

Mailing Address: Texas Instruments, Post Office Box 655303, Dallas, Texas 75265
Copyright © 2022, Texas Instruments Incorporated