

National Semiconductor is now part of  
Texas Instruments.

Search <http://www.ti.com/> for the latest technical  
information and details on our current products and services.

# LM119/LM219/LM319 High Speed Dual Comparator

## General Description

The LM119 series are precision high speed dual comparators fabricated on a single monolithic chip. They are designed to operate over a wide range of supply voltages down to a single 5V logic supply and ground. Further, they have higher gain and lower input currents than devices like the LM710. The uncommitted collector of the output stage makes the LM119 compatible with RTL, DTL and TTL as well as capable of driving lamps and relays at currents up to 25 mA.

The LM319A offers improved precision over the standard LM319, with tighter tolerances on offset voltage, offset current, and voltage gain.

## Features

- Two independent comparators
- Operates from a single 5V supply

- Typically 80 ns response time at  $\pm 15V$
- Minimum fan-out of 2 each side
- Maximum input current of  $1 \mu A$  over temperature
- Inputs and outputs can be isolated from system ground
- High common mode slew rate

Although designed primarily for applications requiring operation from digital logic supplies, the LM119 series are fully specified for power supplies up to  $\pm 15V$ . It features faster response than the LM111 at the expense of higher power dissipation. However, the high speed, wide operating voltage range and low package count make the LM119 much more versatile than older devices like the LM711.

The LM119 is specified from  $-55^{\circ}C$  to  $+125^{\circ}C$ , the LM219 is specified from  $-25^{\circ}C$  to  $+85^{\circ}C$ , and the LM319A and LM319 are specified from  $0^{\circ}C$  to  $+70^{\circ}C$ .

## Connection Diagrams

Dual-In-Line-Package

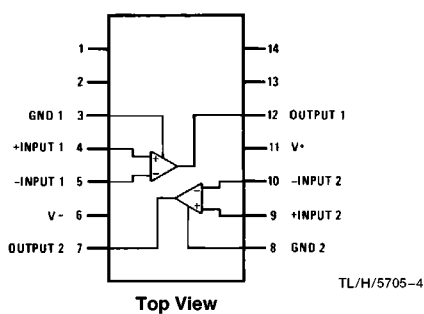

Order Number LM119J, LM119J/883\*, LM219J, LM319J, LM319AM, LM319M, LM319AN or LM319N  
See NS Package Number J14A, M14A or N14A

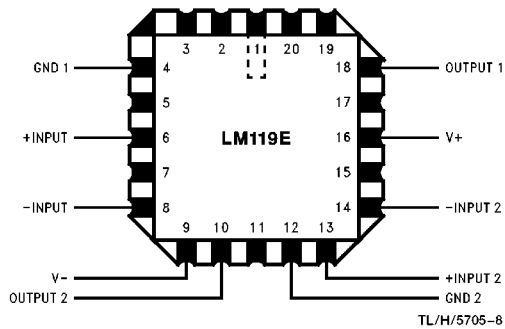

Order Number LM119E/883  
See NS Package Number E20A

Metal Can Package

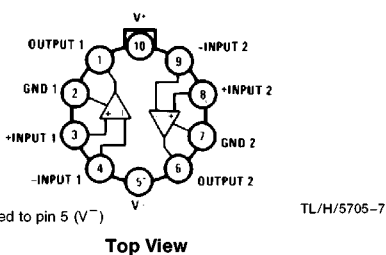

Case is connected to pin 5 ( $V^-$ )

Order Number LM119H, LM119H/883\*, or LM319H  
See NS Package Number H10C

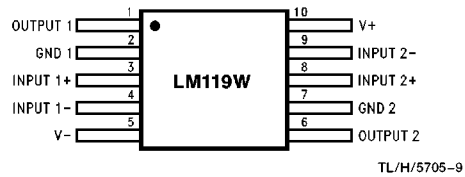

Order Number LM119W/883  
See NS Package Number W10A

\*Also available per SMD# 8601401 or JM38510/10306

## Absolute Maximum Ratings

If Military/Aerospace specified devices are required, please contact the National Semiconductor Sales Office/Distributors for availability and specifications. (Note 7)

Total Supply Voltage	36V
Output to Negative Supply Voltage	36V
Ground to Negative Supply Voltage	25V
Ground to Positive Supply Voltage	18V
Differential Input Voltage	±5V
Input Voltage (Note 1)	±15V
ESD rating (1.5 kΩ in series with 100 pF)	800V
Power Dissipation (Note 2)	500 mW
Output Short Circuit Duration	10 sec

Storage Temperature Range	−65°C to 150°C
Lead Temperature (Soldering, 10 sec.)	260°C
Soldering Information	
Dual-In-Line Package	
Soldering (10 seconds)	260°C
Small Outline Package	
Vapor Phase (60 seconds)	215°C
Infrared (15 seconds)	220°C

See AN-450 "Surface Mounting Methods and Their Effect on Product Reliability" for other methods of soldering surface mount devices.

## Operating Temperature Range

LM119	−55°C to 125°C
LM219	−25°C to 85°C

## Electrical Characteristics (Note 3)

Parameter	Conditions	LM119/LM219			Units
		Min	Typ	Max	
Input Offset Voltage (Note 4)	$T_A = 25^\circ\text{C}$ , $R_S \leq 5\text{k}$		0.7	4.0	mV
Input Offset Current (Note 4)	$T_A = 25^\circ\text{C}$		30	75	nA
Input Bias Current	$T_A = 25^\circ\text{C}$		150	500	nA
Voltage Gain	$T_A = 25^\circ\text{C}$ (Note 6)	10	40		V/mV
Response Time (Note 5)	$T_A = 25^\circ\text{C}$ , $V_S = \pm 15\text{V}$		80		ns
Saturation Voltage	$V_{IN} \leq -5\text{ mV}$ , $I_{OUT} = 25\text{ mA}$ $T_A = 25^\circ\text{C}$		0.75	1.5	V
Output Leakage Current	$V_{IN} \geq 5\text{ mV}$ , $V_{OUT} = 35\text{V}$ $T_A = 25^\circ\text{C}$		0.2	2	μA
Input Offset Voltage (Note 4)	$R_S \leq 5\text{k}$			7	mV
Input Offset Current (Note 4)				100	nA
Input Bias Current				1000	nA
Input Voltage Range	$V_S = \pm 15\text{V}$ $V^+ = 5\text{V}$ , $V^- = 0$	−12 1	±13	+12 3	V V
Saturation Voltage	$V^+ \geq 4.5\text{V}$ , $V^- = 0$ $V_{IN} \leq -6\text{ mV}$ , $I_{SINK} \leq 3.2\text{ mA}$ $T_A \geq 0^\circ\text{C}$ $T_A \leq 0^\circ\text{C}$		0.23	0.4 0.6	V V
Output Leakage Current	$V_{IN} \geq 5\text{ mV}$ , $V_{OUT} = 35\text{V}$ , $V^- = V_{GND} = 0\text{V}$		1	10	μA
Differential Input Voltage				±5	V
Positive Supply Current	$T_A = 25^\circ\text{C}$ , $V^+ = 5\text{V}$ , $V^- = 0$		4.3		mA
Positive Supply Current	$T_A = 25^\circ\text{C}$ , $V_S = \pm 15\text{V}$		8	11.5	mA
Negative Supply Current	$T_A = 25^\circ\text{C}$ , $V_S = \pm 15\text{V}$		3	4.5	mA

**Note 1:** For supply voltages less than ±15V the absolute maximum input voltage is equal to the supply voltage.

**Note 2:** The maximum junction temperature of the LM119 is 150°C, while that of the LM219 is 110°C. For operating at elevated temperatures, devices in the H10 package must be derated based on a thermal resistance of 160°C/W, junction to ambient, or 19°C/W, junction to case. The thermal resistance of the J14 and N14 packages is 100°C/W, junction to ambient.

**Note 3:** These specifications apply for  $V_S = \pm 15\text{V}$ , and the Ground pin at ground, and  $-55^\circ\text{C} \leq T_A \leq +125^\circ\text{C}$ , unless otherwise stated. With the LM219, however, all temperature specifications are limited to  $-25^\circ\text{C} \leq T_A \leq +85^\circ\text{C}$ . The offset voltage, offset current and bias current specifications apply for any supply voltage from a single 5V supply up to ±15V supplies. Do not operate the device with more than 16V from ground to  $V_S$ .

**Note 4:** The offset voltages and offset currents given are the maximum values required to drive the output within a volt of either supply with a 1 mA load. Thus, these parameters define an error band and take into account the worst case effects of voltage gain and input impedance.

**Note 5:** The response time specified (see definitions) is for a 100 mV input step with 5 mV overdrive.

**Note 6:** Output is pulled up to 15V through a 1.4 kΩ resistor.

**Note 7:** Refer to RETS119X for LM119H/883 and LM119J/883 specifications.

## Absolute Maximum Ratings LM319A/319

If Military/Aerospace specified devices are required, please contact the National Semiconductor Sales Office/Distributors for availability and specifications.

Total Supply Voltage	36V
Output to Negative Supply Voltage	36V
Ground to Negative Supply Voltage	25V
Ground to Positive Supply Voltage	18V
Differential Input Voltage	±5V
Input Voltage (Note 1)	±15V
Power Dissipation (Note 2)	500 mW
Output Short Circuit Duration	10 sec
ESD rating (1.5 kΩ in series with 100 pF)	800V

Storage Temperature Range	−65°C to 150°C
Lead Temperature (Soldering, 10 sec.)	260°C
Soldering Information	
Dual-In-Line Package	
Soldering (10 sec.)	260°C
Small Outline Package	
Vapor Phase (60 sec.)	215°C
Infrared (15 sec.)	220°C

See AN-450 "Surface Mounting Methods and Their Effect on Product Reliability" for other methods of soldering surface mount devices.

## Operating Temperature Range

LM319A, LM319	0°C to 70°C
---------------	-------------

## Electrical Characteristics (Note 3)

Parameter	Conditions	LM319A			LM319			Units
		Min	Typ	Max	Min	Typ	Max	
Input Offset Voltage (Note 4)	$T_A = 25^\circ\text{C}, R_S \leq 5\text{k}$		0.5	1.0		2.0	8.0	mV
Input Offset Current (Note 4)	$T_A = 25^\circ\text{C}$		20	40		80	200	nA
Input Bias Current	$T_A = 25^\circ\text{C}$		150	500		250	1000	nA
Voltage Gain	$T_A = 25^\circ\text{C}$ (Note 6)	20	40		8	40		V/mV
Response Time (Note 5)	$T_A = 25^\circ\text{C}, V_S = \pm 15\text{V}$		80			80		ns
Saturation Voltage	$V_{IN} \leq -10\text{ mV}, I_{OUT} = 25\text{ mA}$ $T_A = 25^\circ\text{C}$		0.75	1.5		0.75	1.5	V
Output Leakage Current	$V_{IN} \geq 10\text{ mV}, V_{OUT} = 35\text{V},$ $V^- = V_{GND} = 0\text{V}, T_A = 25^\circ\text{C}$		0.2	10		0.2	10	μA
Input Offset Voltage (Note 4)	$R_S \leq 5\text{k}$			10			10	mV
Input Offset Current (Note 4)				300			300	nA
Input Bias Current				1000			1200	nA
Input Voltage Range	$V_S = \pm 15\text{V}$ $V^+ = 5\text{V}, V^- = 0$	1	±13	3	1	±13	3	V
Saturation Voltage	$V^+ \geq 4.5\text{V}, V^- = 0$ $V_{IN} \leq -10\text{ mV}, I_{SINK} \leq 3.2\text{ mA}$		0.3	0.4		0.3	0.4	V
Differential Input Voltage				±5			±5	V
Positive Supply Current	$T_A = 25^\circ\text{C}, V^+ = 5\text{V}, V^- = 0$		4.3			4.3		mA
Positive Supply Current	$T_A = 25^\circ\text{C}, V_S = \pm 15\text{V}$		8	12.5		8	12.5	mA
Negative Supply Current	$T_A = 25^\circ\text{C}, V_S = \pm 15\text{V}$		3	5		3	5	mA

**Note 1:** For supply voltages less than ±15 the absolute maximum input voltage is equal to the supply voltage.

**Note 2:** The maximum junction temperature of the LM319A and LM319 is 85°C. For operating at elevated temperatures, devices in the H10 package must be derated based on a thermal resistance of 160°C/W, junction to ambient, or 19°C/W, junction to case. The thermal resistance of the N14 and J14 package is 100°C/W, junction to ambient. The thermal resistance of the M14 package is 115°C/W, junction to ambient.

**Note 3:** These specifications apply for  $V_S = \pm 15\text{V}$ , and  $0^\circ\text{C} \leq T_A \leq 70^\circ\text{C}$ , unless otherwise stated. The offset voltage, offset current and bias current specifications apply for any supply voltage from a single 5V supply up to ±15V supplies. Do not operate the device with more than 16V from ground to  $V_S$ .

**Note 4:** The offset voltages and offset currents given are the maximum values required to drive the output within a volt of either supply with a 1 mA load. Thus, these parameters define an error band and take into account the worst case effects of voltage gain and input impedance.

**Note 5:** The response time specified is for a 100 mV input step with 5 mV overdrive.

**Note 6:** Output is pulled up to 15V through a 1.4 kΩ resistor.

# Typical Performance Characteristics LM119A/LM119/LM219

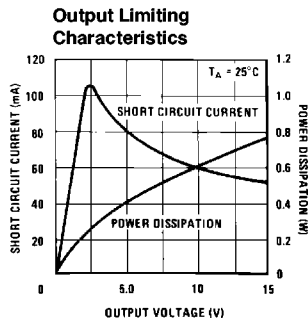
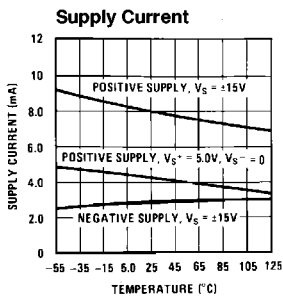
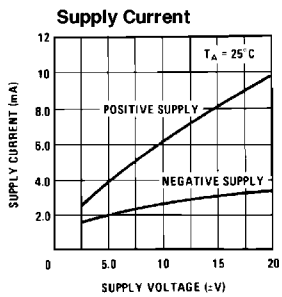
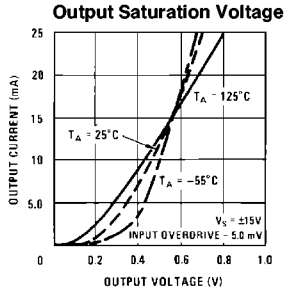
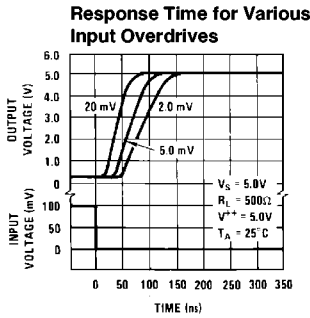
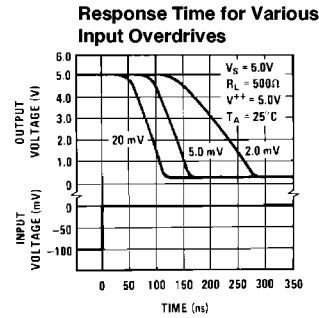
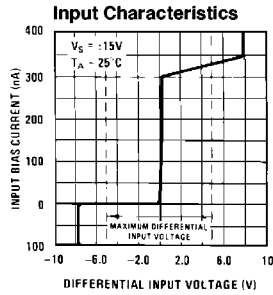
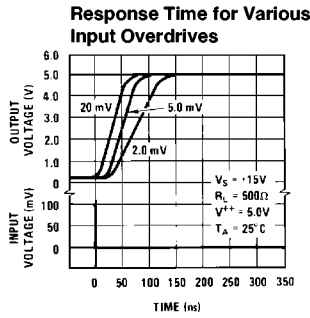
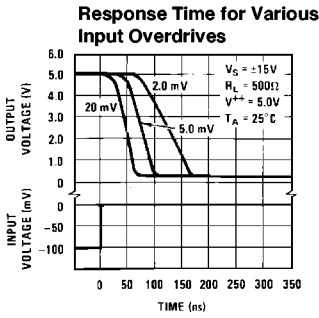
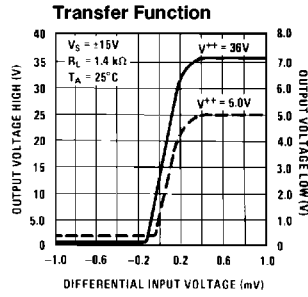
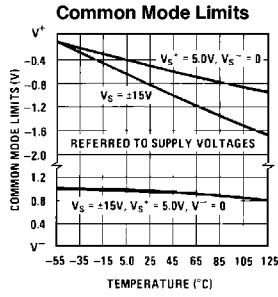
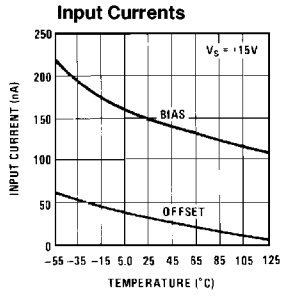

TL/H/5705-2

# Typical Performance Characteristics LM319A, LM319

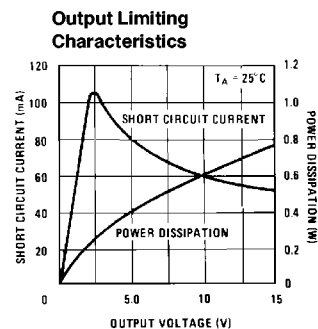
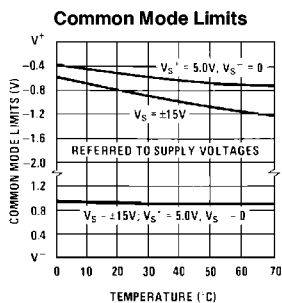
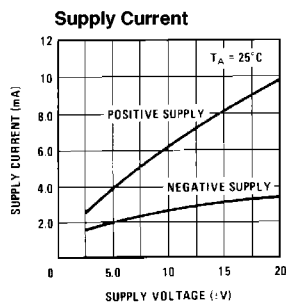
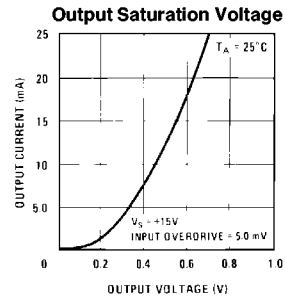
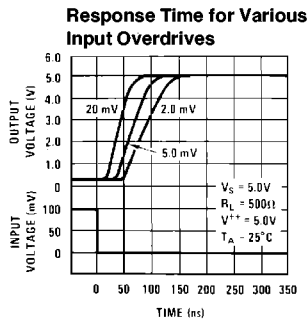
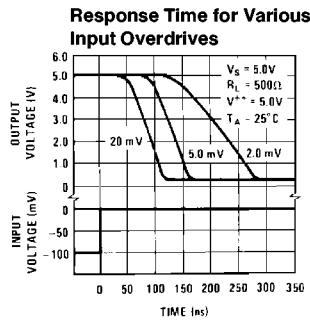
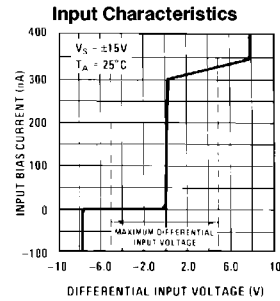
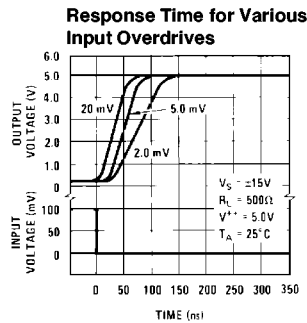
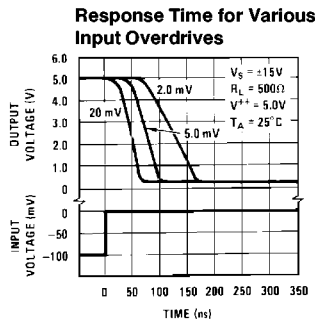
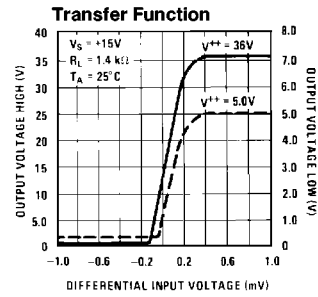
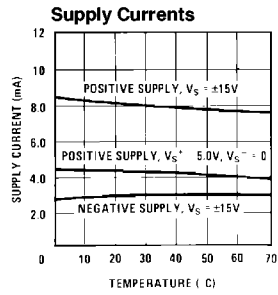
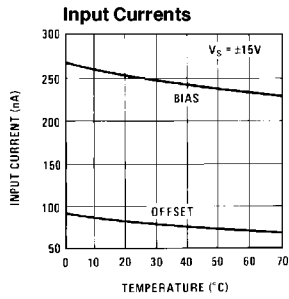

TL/H/5705-3

# Schematic Diagram

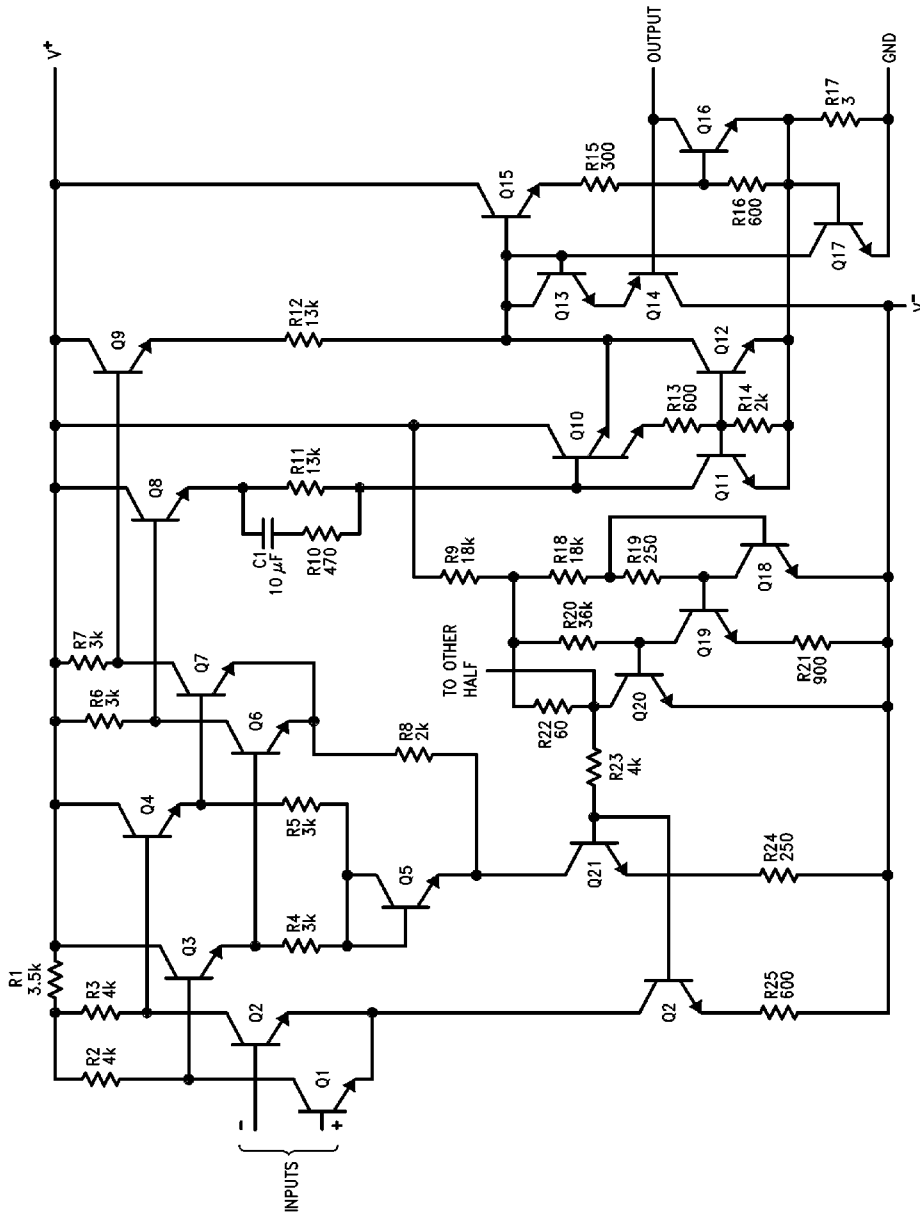

TL/H/5705-1

\*Do not operate the LM119 with more than 16V between GND and V+.

## Typical Applications\*

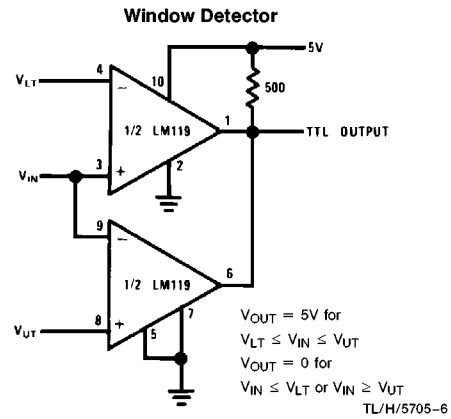
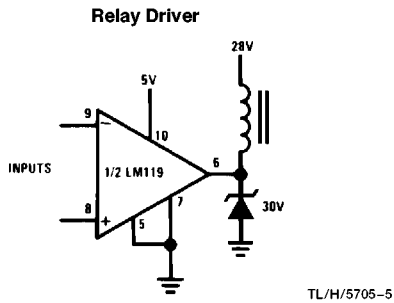

\*Pin numbers are for metal can package.

## Physical Dimensions inches (millimeters)

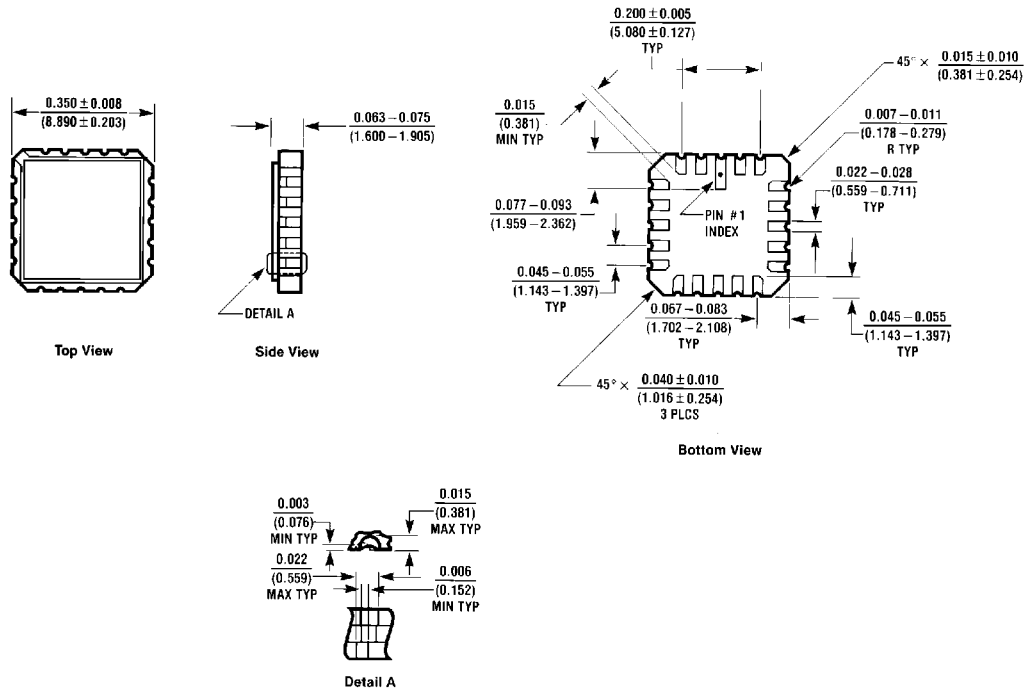

Order Number LM119E/883  
 NS Package Number E20A



**Physical Dimensions** inches (millimeters) (Continued)

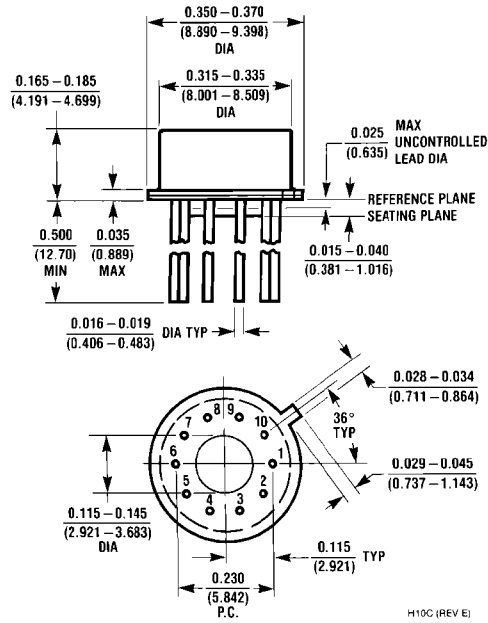

**Metal Can Package (H)**  
**Order Number LM119H, LM119H/883, LM319AH or LM319H**  
**NS Package Number H10C**

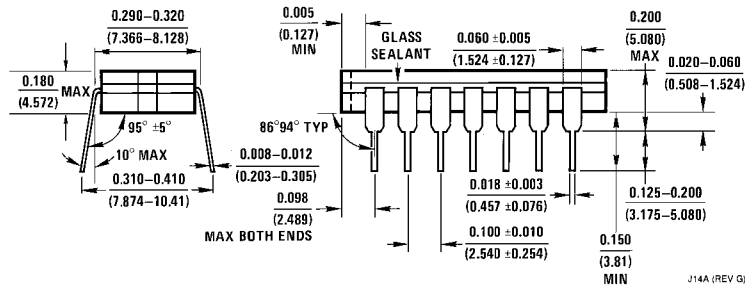
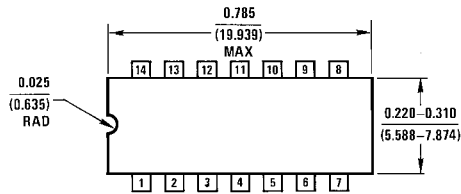

**Cavity Dual-In-Line Package (J)**  
**Order Number LM119J, LM119J/883, LM219J, LM319AJ or LM319J**  
**NS Package Number J14A**

**Physical Dimensions** inches (millimeters) (Continued)

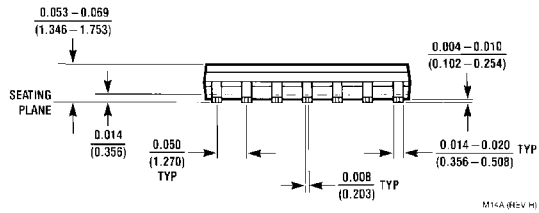
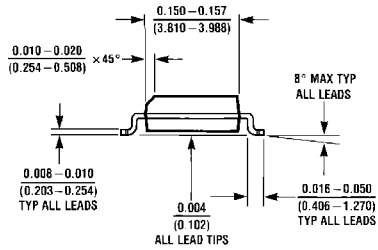
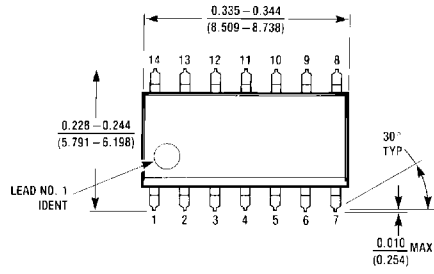

**Dual-In-Line Package (M)**  
Order Number LM319AM or LM319M  
NS Package Number M14A

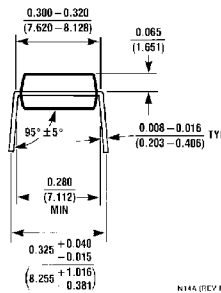
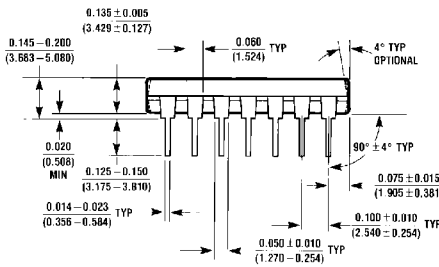
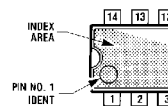
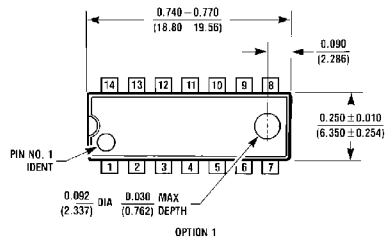

**Molded Dual-In-Line Package (N)**  
Order Number LM319AN or LM319N  
NS Package Number N14A

**Physical Dimensions** inches (millimeters) (Continued)

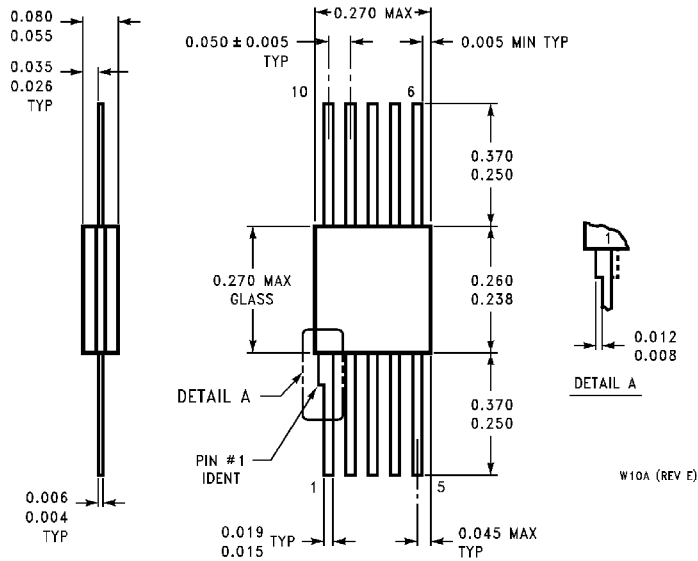

**Order Number LM119W/883**  
**NS Package Number W10A**

**LIFE SUPPORT POLICY**

NATIONAL'S PRODUCTS ARE NOT AUTHORIZED FOR USE AS CRITICAL COMPONENTS IN LIFE SUPPORT DEVICES OR SYSTEMS WITHOUT THE EXPRESS WRITTEN APPROVAL OF THE PRESIDENT OF NATIONAL SEMICONDUCTOR CORPORATION. As used herein:

1. Life support devices or systems are devices or systems which, (a) are intended for surgical implant into the body, or (b) support or sustain life, and whose failure to perform, when properly used in accordance with instructions for use provided in the labeling, can be reasonably expected to result in a significant injury to the user.
2. A critical component is any component of a life support device or system whose failure to perform can be reasonably expected to cause the failure of the life support device or system, or to affect its safety or effectiveness.



**National Semiconductor Corporation**  
 1111 West Bardin Road  
 Arlington, TX 76017  
 Tel: 1(800) 272-9959  
 Fax: 1(800) 737-7018

**National Semiconductor Europe**  
 Fax: (+49) 0-180-530 85 86  
 Email: onjwge@tevm2.nsc.com  
 Deutsch Tel: (+49) 0-180-530 85 85  
 English Tel: (+49) 0-180-532 78 32  
 Français Tel: (+49) 0-180-532 93 58  
 Italiano Tel: (+49) 0-180-534 16 80

**National Semiconductor Hong Kong Ltd.**  
 13th Floor, Straight Block,  
 Ocean Centre, 5 Canton Rd.  
 Tsimshatsui, Kowloon  
 Hong Kong  
 Tel: (852) 2737-1600  
 Fax: (852) 2736-9960

**National Semiconductor Japan Ltd.**  
 Tel: 81-043-299-2309  
 Fax: 81-043-299-2408

National does not assume any responsibility for use of any circuitry described, no circuit patent licenses are implied and National reserves the right at any time without notice to change said circuitry and specifications.