

## Rail-to-rail high-speed comparator

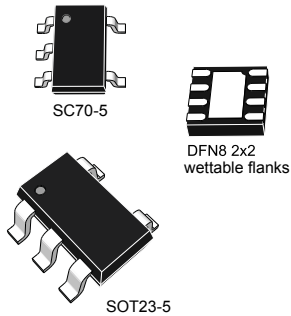

### Features

- Propagation delay: 8 ns
- Low current consumption: 470  $\mu$ A typ. at 5 V
- Rail-to-rail inputs
- Push-pull outputs
- Supply operation from 2.2 to 5 V
- Wide temperature range: -40 °C to 125 °C
- ESD tolerance: 2 kV HBM/200 V MM
- Available in SOT23-5, SC70-5 and DFN8 2x2 wettable flanks
- Automotive qualification

### Applications

- Telecoms
- Instrumentation
- Signal conditioning
- High-speed sampling systems
- Portable communication systems

Product status link

[TS3011](#)

### Description

The **TS3011** single comparator features a high-speed response time with rail-to-rail inputs. Specified for a supply voltage of 2.2 to 5 V, this comparator can operate over a wide temperature range from -40 °C to 125 °C.

The **TS3011** offers micropower consumption as low as a few hundred microamperes, thus providing an excellent ratio of power consumption current versus response time.

The **TS3011** includes push-pull outputs and is available in tiny packages to overcome space constraints.

# 1 Pin configuration

Figure 1. Pin configuration

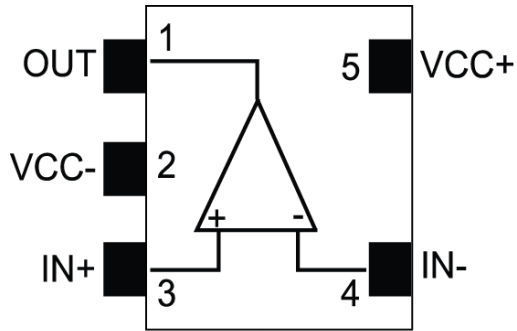

SOT23-5 and SC70-5

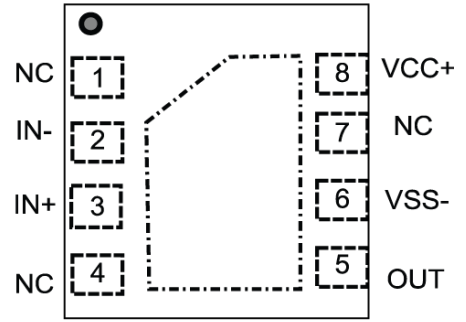

DFN8 2x2  
wetable flanks

Note: Exposed pad can be left floating or connected to ground.

## 2 Absolute maximum ratings and operating conditions

**Table 1. Absolute maximum ratings**

Symbol	Parameter		Value	Unit
V <sub>CC</sub>	Supply voltage <sup>(1)</sup>		5.5	V
V <sub>ID</sub>	Differential input voltage <sup>(2)</sup>		±5	
V <sub>IN</sub>	Input voltage range		(V <sub>CC</sub> <sup>-</sup> ) - 0.3 to (V <sub>CC</sub> <sup>+</sup> ) + 0.3	
R <sub>THJA</sub>	Thermal resistance junction-to-ambient <sup>(3)</sup>	SOT23-5	250	°C/W
		SC70-5	205	
		DFN8 2x2	57	
R <sub>THJC</sub>	Thermal resistance junction-to-case <sup>(3)</sup>	SOT23-5	81	
		SC70-5	172	
		DFN8 2x2	26	
T <sub>STG</sub>	Storage temperature		-65 to 150	°C
T <sub>J</sub>	Junction temperature		150	
T <sub>LEAD</sub>	Lead temperature (soldering 10 seconds)		260	
ESD	Human body model (HBM) <sup>(4)</sup>		2000	V
	Machine model (MM) <sup>(5)</sup>		200	
	Charged device model (CDM) <sup>(6)</sup>	DFN8 2x2/ SOT23-5	1500	
		SC70-5	1300	

1. All voltage values, except the differential voltage, are referenced to V<sub>CC</sub><sup>-</sup>.
2. The magnitude of input and output voltages must never exceed the supply rail ±0.3 V.
3. Short-circuits can cause excessive heating. These values are typical.
4. Human body model: a 100 pF capacitor is charged to the specified voltage, then discharged through a 1.5 kΩ resistor between two pins of the device. This is done for all couples of connected pin combinations while the other pins are floating.
5. Machine model: a 200 pF capacitor is charged to the specified voltage, then discharged directly between two pins of the device with no external series resistor (internal resistor < 5 Ω). This is done for all couples of connected pin combinations while the other pins are floating.
6. Charged device model: all pins and package are charged together to the specified voltage and then discharged directly to ground.

**Table 2. Operating conditions**

Symbol	Parameter	Value	Unit
T <sub>Oper</sub>	Operating temperature range	-40 to 125	°C
V <sub>CC</sub>	Supply voltage (V <sub>CC</sub> <sup>+</sup> - V <sub>CC</sub> <sup>-</sup> ), -40 °C < T <sub>amb</sub> < 125 °C	2.2 to 5	V
V <sub>ICM</sub>	Common mode input voltage range, -40 °C < T <sub>amb</sub> < 125 °C	(V <sub>CC</sub> <sup>-</sup> ) - 0.2 to (V <sub>CC</sub> <sup>+</sup> ) + 0.2	

### 3 Electrical characteristics

In the electrical characteristic tables below, all values over the temperature range are guaranteed through correlation and simulation. No production tests are performed at the temperature range limits.

**Table 3.  $V_{CC} = 2.2\text{ V}$ ,  $V_{ICM} = V_{CC}/2$ ,  $T_{amb} = 25\text{ °C}$  (unless otherwise specified)**

Symbol	Parameter	Test conditions	Min.	Typ.	Max.	Unit
$V_{IO}$	Input offset voltage <sup>(1)</sup>		-7	-0.2	7	mV
		$-40\text{ °C} < T_{amb} < 125\text{ °C}$	-8		8	
$\Delta V_{IO}$	Input offset voltage drift	$-40\text{ °C} < T_{amb} < 125\text{ °C}$		5	20	$\mu\text{V}/\text{°C}$
$V_{HYST}$	Input hysteresis voltage <sup>(2)</sup>			2		mV
$I_{IO}$	Input offset current <sup>(3)</sup>			1	20	pA
		$-40\text{ °C} < T_{amb} < 125\text{ °C}$			100	
$I_{IB}$	Input bias current			1	20	pA
		$-40\text{ °C} < T_{amb} < 125\text{ °C}$			100	
$I_{CC}$	Supply current	No load, output high		0.52	0.64	mA
		No load, output high, $-40\text{ °C} < T_{amb} < 125\text{ °C}$			0.9	
		No load, output low		0.65	0.88	
		No load, output low, $-40\text{ °C} < T_{amb} < 125\text{ °C}$			1.1	
$I_{SC}$	Short circuit current	Source	14	18		mA
		Sink	11	14		
$V_{OH}$	Output voltage high	$I_{source} = 4\text{ mA}$	1.94	1.97		V
		$-40\text{ °C} < T_{amb} < 125\text{ °C}$	1.85			
$V_{OL}$	Output voltage low	$I_{sink} = 4\text{ mA}$		150	190	mV
		$-40\text{ °C} < T_{amb} < 125\text{ °C}$			250	
CMRR	Common-mode rejection ratio	$0 < V_{ICM} < 2.7\text{ V}$	50	68		dB
$T_{PLH}$	Propagation delay, low to high output level <sup>(4)</sup>	$C_L = 12\text{ pF}$ , $R_L = 1\text{ M}\Omega$ , overdrive = 5 mV		16		ns
		$C_L = 12\text{ pF}$ , $R_L = 1\text{ M}\Omega$ , overdrive = 15 mV		12		
		$C_L = 12\text{ pF}$ , $R_L = 1\text{ M}\Omega$ , overdrive = 50 mV		10	15	
$T_{PHL}$	Propagation delay, high to low output level <sup>(5)</sup>	$C_L = 12\text{ pF}$ , $R_L = 1\text{ M}\Omega$ , overdrive = 5 mV		16		ns
		$C_L = 12\text{ pF}$ , $R_L = 1\text{ M}\Omega$ , overdrive = 15 mV		12		
		$C_L = 12\text{ pF}$ , $R_L = 1\text{ M}\Omega$ , overdrive = 50 mV		10	15	
$T_R$	Rise time (10 % to 90 %)	$C_L = 12\text{ pF}$ , $R_L = 1\text{ M}\Omega$ , overdrive = 100 mV		3.0		ns
$T_F$	Fall time (90 % to 10 %)	$C_L = 12\text{ pF}$ , $R_L = 1\text{ M}\Omega$ , overdrive = 100 mV		2.5		ns

1. The offset is defined as the average value of positive ( $V_{TRIP+}$ ) and negative ( $V_{TRIP-}$ ) trip points (input voltage differences) requested to change the output state in each direction.
2. Hysteresis is a built-in feature of the TS3011. It is defined as the voltage difference between the trip points.
3. Maximum values include unavoidable inaccuracies of the industrial tests.
4. Overdrive is measured with reference to the  $V_{TRIP+}$  point.
5. Overdrive is measured with reference to the  $V_{TRIP-}$  point.

**Table 4.  $V_{CC} = 2.7\text{ V}$ ,  $V_{ICM} = V_{CC}/2$ ,  $T_{amb} = 25\text{ °C}$  (unless otherwise specified)**

Symbol	Parameter	Test conditions	Min.	Typ.	Max.	Unit
$V_{IO}$	Input offset voltage <sup>(1)</sup>		-7	-0.1	7	mV
		$-40\text{ °C} < T_{amb} < 125\text{ °C}$	-9		9	
$\Delta V_{IO}$	Input offset voltage drift	$-40\text{ °C} < T_{amb} < 125\text{ °C}$		5	20	$\mu\text{V}/\text{°C}$
$V_{HYST}$	Input hysteresis voltage <sup>(2)</sup>			2		mV
$I_{IO}$	Input offset current <sup>(3)</sup>			1	20	pA
		$-40\text{ °C} < T_{amb} < 125\text{ °C}$			100	
$I_{IB}$	Input bias current			1	20	pA
		$-40\text{ °C} < T_{amb} < 125\text{ °C}$			100	
$I_{CC}$	Supply current	No load, output high		0.52	0.65	mA
		No load, output high, $-40\text{ °C} < T_{amb} < 125\text{ °C}$			0.9	
		No load, output low		0.66	0.89	
		No load, output low, $-40\text{ °C} < T_{amb} < 125\text{ °C}$			1.1	
$I_{SC}$	Short circuit current	Source	24	27		mA
		Sink	19	22		
$V_{OH}$	Output voltage high	$I_{source} = 4\text{ mA}$	2.48	2.52		V
		$-40\text{ °C} < T_{amb} < 125\text{ °C}$	2.40			
$V_{OL}$	Output voltage low	$I_{sink} = 4\text{ mA}$		130	170	mV
		$-40\text{ °C} < T_{amb} < 125\text{ °C}$			220	
CMRR	Common-mode rejection ratio	$0 < V_{ICM} < 2.7\text{ V}$	52	70		dB
$T_{PLH}$	Propagation delay, low to high output level <sup>(4)</sup>	$C_L = 12\text{ pF}$ , $R_L = 1\text{ M}\Omega$ , overdrive = 5 mV		16		ns
		$C_L = 12\text{ pF}$ , $R_L = 1\text{ M}\Omega$ , overdrive = 15 mV		11		
		$C_L = 12\text{ pF}$ , $R_L = 1\text{ M}\Omega$ , overdrive = 50 mV		9	13	
$T_{PHL}$	Propagation delay, high to low output level <sup>(5)</sup>	$C_L = 12\text{ pF}$ , $R_L = 1\text{ M}\Omega$ , overdrive = 5 mV		16		ns
		$C_L = 12\text{ pF}$ , $R_L = 1\text{ M}\Omega$ , overdrive = 15 mV		11		
		$C_L = 12\text{ pF}$ , $R_L = 1\text{ M}\Omega$ , overdrive = 50 mV		9	13	
$T_R$	Rise time (10 % to 90 %)	$C_L = 12\text{ pF}$ , $R_L = 1\text{ M}\Omega$ , overdrive = 100 mV		2.3		ns
$T_F$	Fall time (90 % to 10 %)	$C_L = 12\text{ pF}$ , $R_L = 1\text{ M}\Omega$ , overdrive = 100 mV		1.8		ns

1. The offset is defined as the average value of positive ( $V_{TRIP+}$ ) and negative ( $V_{TRIP-}$ ) trip points (input voltage differences) requested to change the output state in each direction.
2. Hysteresis is a built-in feature of the TS3011. It is defined as the voltage difference between the trip points.
3. Maximum values include unavoidable inaccuracies of the industrial tests.
4. Overdrive is measured with reference to the  $V_{TRIP+}$  point.
5. Overdrive is measured with reference to the  $V_{TRIP-}$  point.

**Table 5.**  $V_{CC} = 5\text{ V}$ ,  $V_{ICM} = V_{CC}/2$ ,  $T_{amb} = 25\text{ }^{\circ}\text{C}$  (unless otherwise specified)

Symbol	Parameter	Test conditions	Min.	Typ.	Max.	Unit
$V_{IO}$	Input offset voltage <sup>(1)</sup>		-7	-0.4	7	mV
		$-40\text{ }^{\circ}\text{C} < T_{amb} < 125\text{ }^{\circ}\text{C}$	-9		9	
$\Delta V_{IO}$	Input offset voltage drift	$-40\text{ }^{\circ}\text{C} < T_{amb} < 125\text{ }^{\circ}\text{C}$		10	30	$\mu\text{V}/^{\circ}\text{C}$
$V_{HYST}$	Input hysteresis voltage <sup>(2)</sup>			2		mV
$I_{IO}$	Input offset current <sup>(3)</sup>			1	20	pA
		$-40\text{ }^{\circ}\text{C} < T_{amb} < 125\text{ }^{\circ}\text{C}$			100	
$I_{IB}$	Input bias current			1	20	pA
		$-40\text{ }^{\circ}\text{C} < T_{amb} < 125\text{ }^{\circ}\text{C}$			100	
$I_{CC}$	Supply current	No load, output high		0.47	0.69	mA
		No load, output high, $-40\text{ }^{\circ}\text{C} < T_{amb} < 125\text{ }^{\circ}\text{C}$			0.9	
		No load, output low		0.60	0.91	
		No load, output low, $-40\text{ }^{\circ}\text{C} < T_{amb} < 125\text{ }^{\circ}\text{C}$			1.1	
$I_{SC}$	Short circuit current	Source	58	62		mA
		Sink	58	64		
$V_{OH}$	Output voltage high	$I_{source} = 4\text{ mA}$	4.84	4.89		V
		$-40\text{ }^{\circ}\text{C} < T_{amb} < 125\text{ }^{\circ}\text{C}$	4.80			
$V_{OL}$	Output voltage low	$I_{sink} = 4\text{ mA}$		90	120	mV
		$-40\text{ }^{\circ}\text{C} < T_{amb} < 125\text{ }^{\circ}\text{C}$			180	
CMRR	Common-mode rejection ratio	$0 < V_{ICM} < 2.7\text{ V}$	57	74		dB
SVR	Supply voltage rejection	$\Delta V_{CC} = 2.2\text{ V to } 5\text{ V}$		79		
$T_{PLH}$	Propagation delay, low to high output level <sup>(4)</sup>	$C_L = 12\text{ pF}$ , $R_L = 1\text{ M}\Omega$ , overdrive = 5 mV		14		ns
		$C_L = 12\text{ pF}$ , $R_L = 1\text{ M}\Omega$ , overdrive = 15 mV		10		
		$C_L = 12\text{ pF}$ , $R_L = 1\text{ M}\Omega$ , overdrive = 50 mV		8	11	
$T_{PHL}$	Propagation delay, high to low output level <sup>(5)</sup>	$C_L = 12\text{ pF}$ , $R_L = 1\text{ M}\Omega$ , overdrive = 5 mV		16		ns
		$C_L = 12\text{ pF}$ , $R_L = 1\text{ M}\Omega$ , overdrive = 15 mV		11		
		$C_L = 12\text{ pF}$ , $R_L = 1\text{ M}\Omega$ , overdrive = 50 mV		9	12	
$T_R$	Rise time (10 % to 90 %)	$C_L = 12\text{ pF}$ , $R_L = 1\text{ M}\Omega$ , overdrive = 100 mV		1.1		ns
$T_F$	Fall time (90 % to 10 %)	$C_L = 12\text{ pF}$ , $R_L = 1\text{ M}\Omega$ , overdrive = 100 mV		1.0		

1. The offset is defined as the average value of positive ( $V_{TRIP+}$ ) and negative ( $V_{TRIP-}$ ) trip points (input voltage differences) requested to change the output state in each direction.
2. Hysteresis is a built-in feature of the TS3011. It is defined as the voltage difference between the trip points.
3. Maximum values include unavoidable inaccuracies of the industrial tests.
4. Overdrive is measured with reference to the  $V_{TRIP+}$  point.
5. Overdrive is measured with reference to the  $V_{TRIP-}$  point.

## 4 Electrical characteristic curves

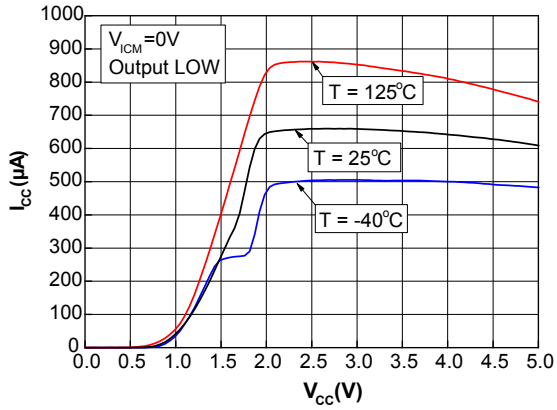
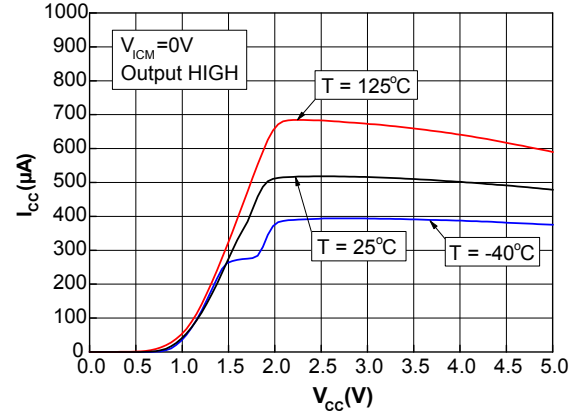
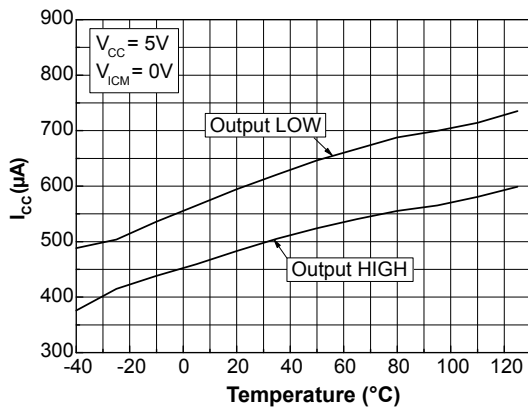
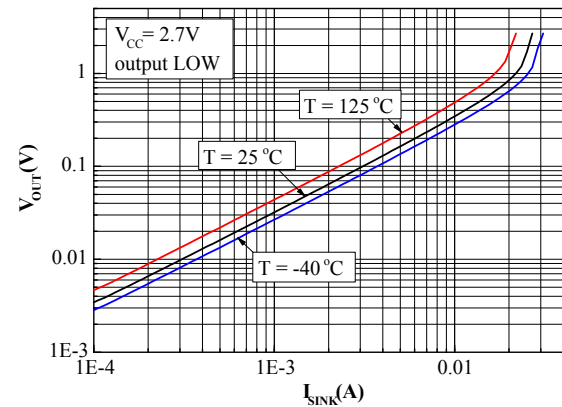
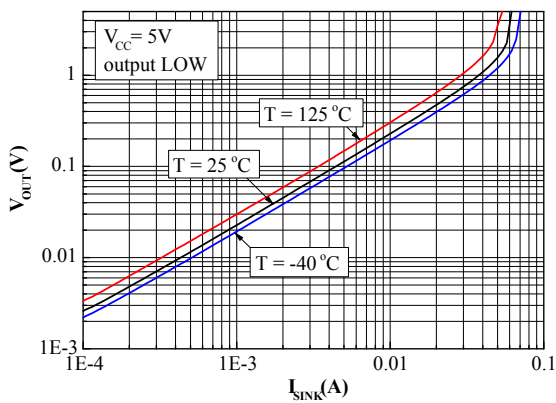
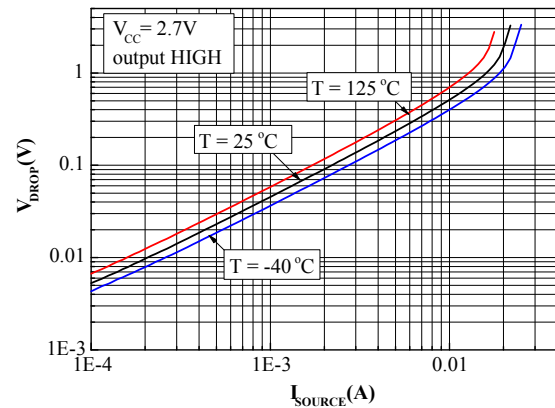
**Figure 2. Current consumption vs. power supply voltage - output low**

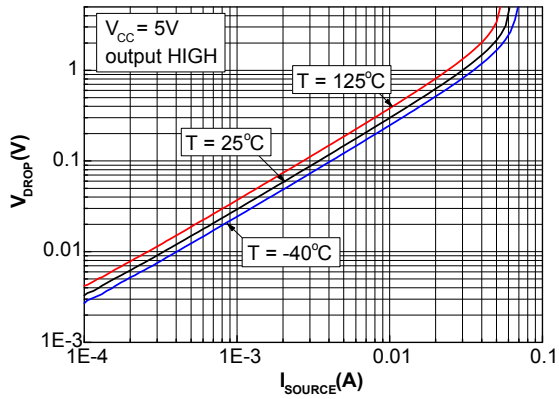
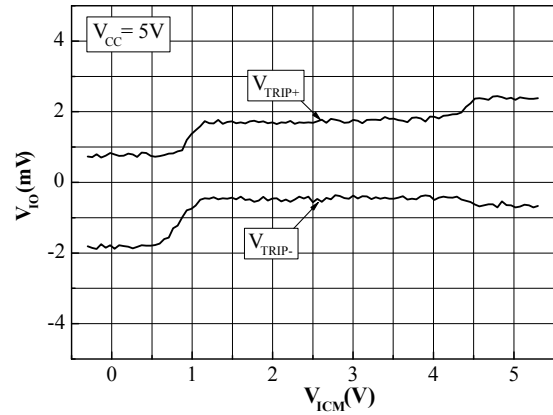
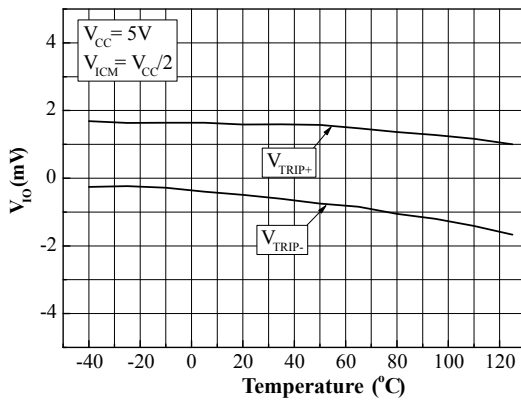
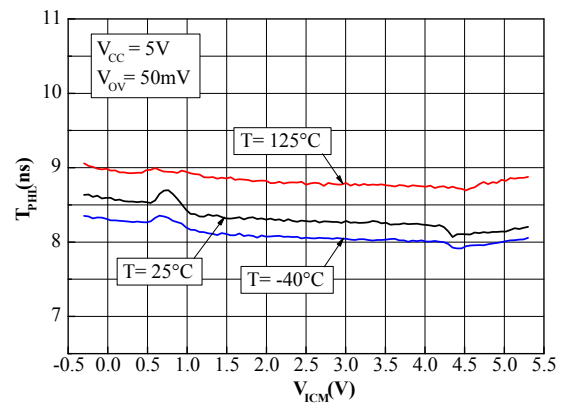
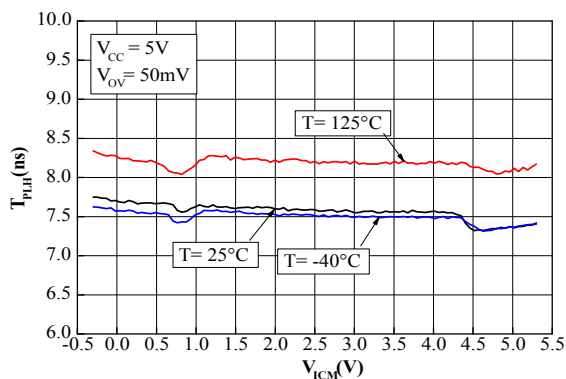
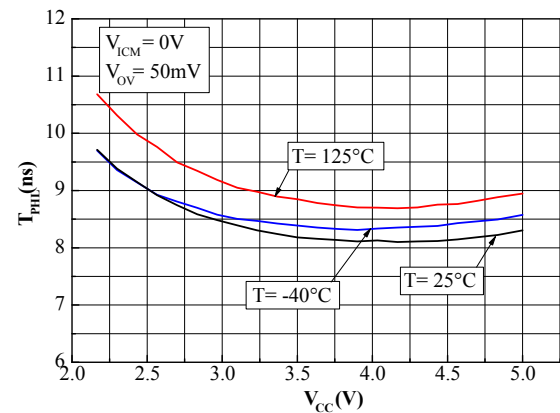
**Figure 3. Current consumption vs. power supply voltage - output high**

**Figure 4. Current consumption vs. temperature**

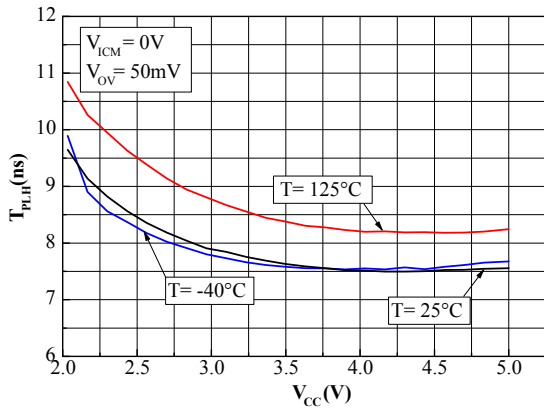
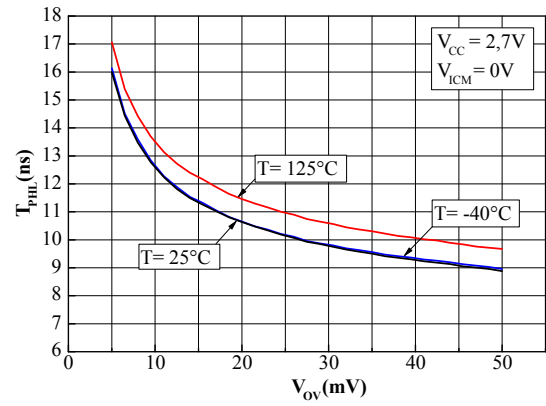
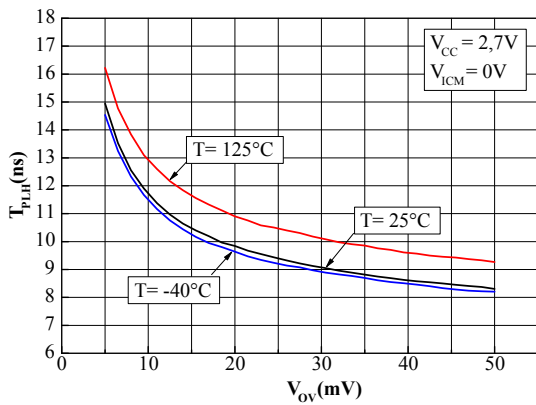
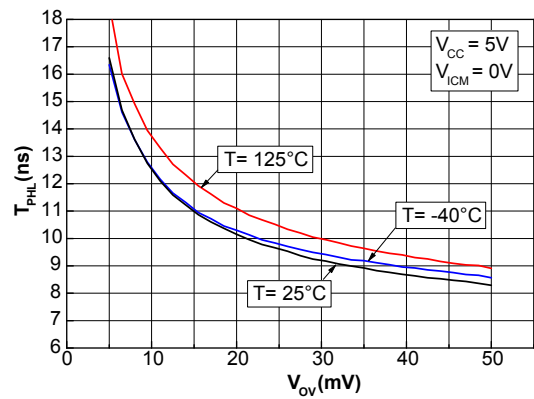
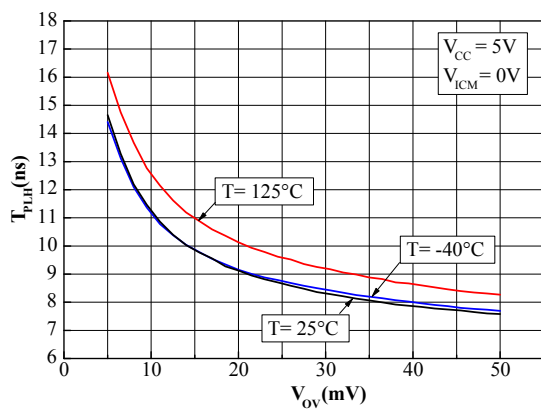
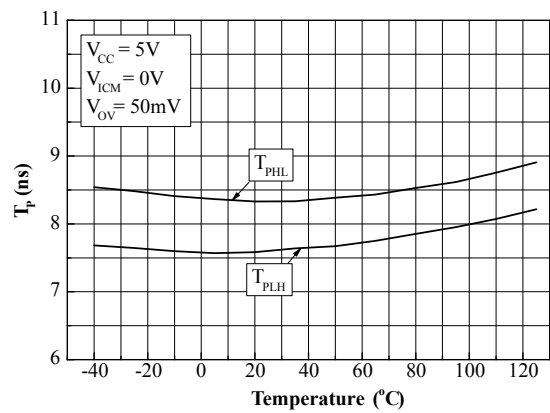
**Figure 5. Output voltage vs. sinking current, output low, V<sub>CC</sub> = 2.7 V**

**Figure 6. Output voltage vs. sinking current, output low, V<sub>CC</sub> = 5 V**

**Figure 7. Output voltage drop vs. sourcing current, output high, V<sub>CC</sub> = 2.7 V**

**Figure 8. Output voltage drop vs. sourcing current, output high, V<sub>CC</sub> = 5 V**

**Figure 9. Input offset voltage vs. common mode voltage**

**Figure 10. Input offset voltage vs. temperature**

**Figure 11. Propagation delay vs. common mode voltage with negative transition**

**Figure 12. Propagation delay vs. common mode voltage with positive transition**

**Figure 13. Propagation delay vs. power supply voltage with negative transition**



**Figure 14. Propagation delay vs. power supply voltage with positive transition**

**Figure 15. Propagation delay vs. overdrive with negative transition,  $V_{CC} = 2.7V$** 

**Figure 16. Propagation delay vs. overdrive with positive transition,  $V_{CC} = 2.7V$** 

**Figure 17. Propagation delay vs. overdrive with negative transition,  $V_{CC} = 5V$** 

**Figure 18. Propagation delay vs. overdrive with positive transition,  $V_{CC} = 5V$** 

**Figure 19. Propagation delay vs. temperature**

## 5 Application recommendation

When high speed comparators are used, it is strongly recommended to place a capacitor as close as possible to the supply pins. Decoupling has two main advantages for this application: it helps to reduce electromagnetic interference and rejects the ripple that may appear on the output.

A bypass capacitor combination, composed of 100 nF in addition to 10 nF and 1 nF in parallel is recommended because it eliminates spikes on the supply line better than a single 100 nF capacitor. Each millimeter of the PCB track plays an important role. Bypass capacitors must be placed as close as possible to the comparator supply pin.

The smallest value capacitor should be preferably placed closer to the supply pin.

In addition, important values of input impedance in series with parasitic PCB capacity and input comparator capacity create an additional RC filter. It generates an additional propagation delay.

For high speed signal applications, PCB must be designed with great care taking into consideration low resistive grounding, short tracks and quality SMD capacitors featuring low ESR. Bypass capacitor stores energy and provides a complementary energy tank when spikes occur on the power supply line. If the input signal frequency is far from the resonant frequency, impedance strongly increases and the capacitor loses bypassing capability. Placing different capacitors with different resonant frequencies allows a wide frequency bandwidth to be covered. It is also recommended to implement an unbroken ground plane with low inductance.

**Figure 20. High speed layout recommendation**

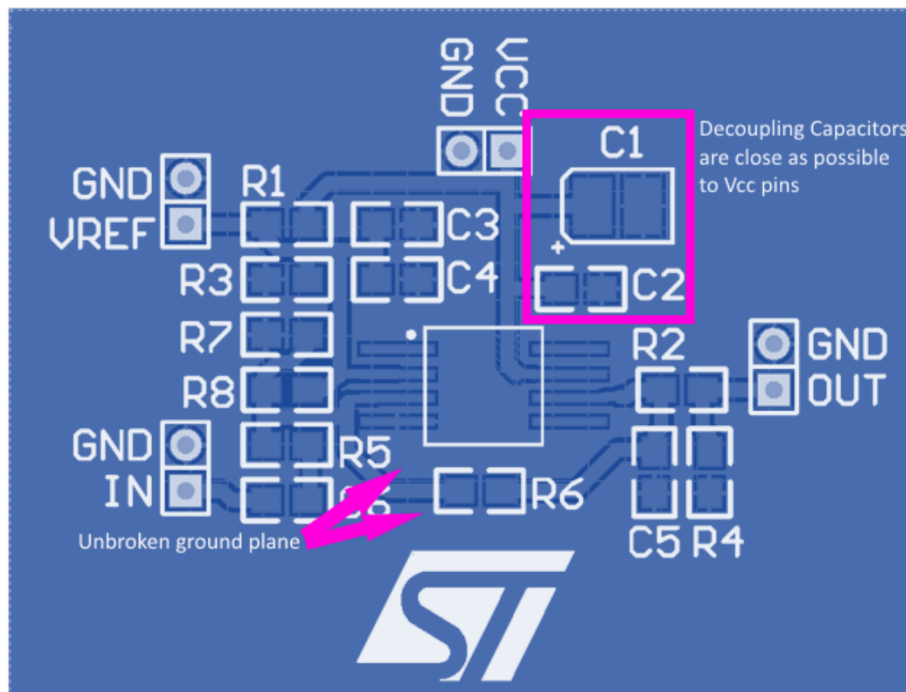

## 6 Package information

In order to meet environmental requirements, ST offers these devices in different grades of **ECOPACK** packages, depending on their level of environmental compliance. ECOPACK specifications, grade definitions and product status are available at: [www.st.com](http://www.st.com). ECOPACK is an ST trademark.

### 6.1 SOT23-5 package information

**Figure 21. SOT23-5 package outline**

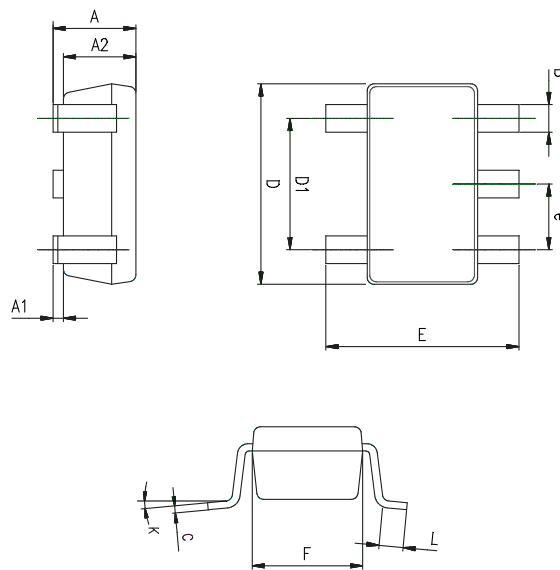

**Table 6. SOT23-5 mechanical data**

Ref.	Dimensions					
	Millimeters			Inches		
	Min.	Typ.	Max.	Min.	Typ.	Max.
A	0.90	1.20	1.45	0.035	0.047	0.057
A1			0.15			0.006
A2	0.90	1.05	1.30	0.035	0.041	0.051
B	0.35	0.40	0.50	0.014	0.016	0.020
C	0.09	0.15	0.20	0.004	0.006	0.008
D	2.80	2.90	3.00	0.110	0.114	0.118
D1		1.90			0.075	
e		0.95			0.037	
E	2.60	2.80	3.00	0.102	0.110	0.118
F	1.50	1.60	1.75	0.059	0.063	0.069
L	0.10	0.35	0.60	0.004	0.014	0.024
K	0 degrees		10 degrees	0 degrees		10 degrees

## 6.2 SC70-5 (or SOT323-5) package information

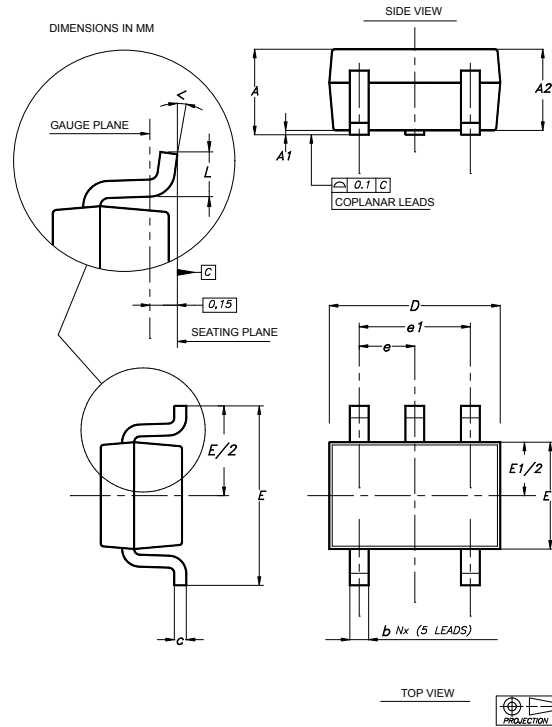
**Figure 22. SC70-5 (or SOT323-5) package outline**

**Table 7. SC70-5 (or SOT323-5) mechanical data**

Ref.	Dimensions					
	Millimeters			Inches		
	Min.	Typ.	Max.	Min.	Typ.	Max.
A	0.80		1.10	0.032		0.043
A1			0.10			0.004
A2	0.80	0.90	1.00	0.032	0.035	0.039
b	0.15		0.30	0.006		0.012
c	0.10		0.22	0.004		0.009
D	1.80	2.00	2.20	0.071	0.079	0.087
E	1.80	2.10	2.40	0.071	0.083	0.094
E1	1.15	1.25	1.35	0.045	0.049	0.053
e		0.65			0.025	
e1		1.30			0.051	
L	0.26	0.36	0.46	0.010	0.014	0.018
<	0°		8°	0°		8°

### 6.3 DFN8 2x2 mm package information

Figure 23. DFN8 2x2 mm package outline

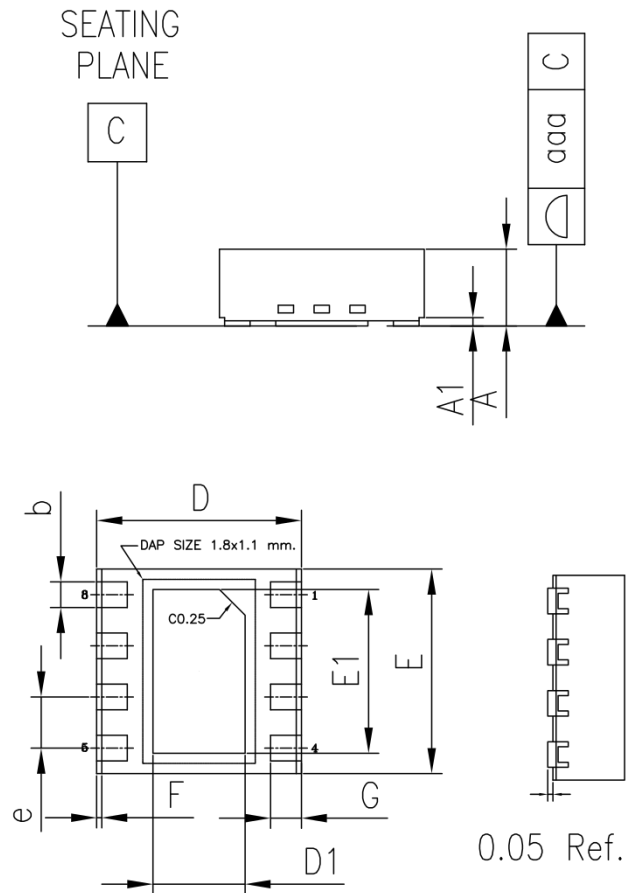

Table 8. DFN8 2x2 mm package mechanical data

Ref.	Dimensions					
	Millimeters			Inches		
	Min.	Typ.	Max.	Min.	Typ.	Max.
A	0.70	0.75	0.80	0.027	0.029	0.031
A1		0.10			0.003	
b	0.20	0.25	0.30	0.007	0.009	0.011
D	1.95	2.00	2.05	0.076	0.078	0.080
D1	0.80	0.90	1.00	0.031	0.035	0.039
E	1.95	2.00	2.05	0.076	0.078	0.080
E1	1.50	1.60	1.70	0.059	0.062	0.066
e		0.50			0.019	
F		0.05			0.001	
G	0.25	0.30	0.35	0.009	0.011	0.013
aaa		0.10			0.003	

## 7 Ordering information

**Table 9. Order codes**

Part number	Temperature range	Package	Packaging	Marking
TS3011ILT	-40 °C to 125 °C	SOT23-5	Tape and reel	K540
TS3011IYLT <sup>(1)</sup>				K541
TS3011ICT		SC70-5		K54
TS3011IYCT <sup>(1)</sup>				K5N
TS3011IYQ3T <sup>(1)</sup>		DFN8 2x2, wettable flanks		K5N

1. Qualified and characterized according to AEC Q100 and Q003 or equivalent, advanced screening according to AEC Q001 and Q 002 or equivalent.

## Revision history

**Table 10. Document revision history**

Date	Revision	Changes
03-Oct-2011	1	Initial release.
18-Feb-2014	2	Updated Table 8: Order codes to add the order code TS3011IYLT. Added: Automotive qualification among the Features in the cover page.
27-May-2016	3	Updated document layout Section 3: "Electrical characteristics": updated unit of "Input offset voltage drift" parameter to $\mu\text{V}/^\circ\text{C}$ (not $\text{mV}/^\circ\text{C}$ ). Section 4: "Electrical characteristic curves": X-axes changed to mV (not V) in figures 15, 16, 17, and 18. Table 6: added "K" values for inches Table 7: updated A and A2 min values for inches and added "<" values for inches.
25-Aug-2017	4	Updated cover page image and description. Updated Figure 1: "Pin connections (top view)" and Table 9: "Order codes". Added Section 5.3: "TS3011 DFN package information".
07-Dec-2017	5	Removed package pin connection section. Added Application recommendation.
04-Oct-2021	6	Updated Section Features and Table 1. Absolute maximum ratings. Minor text changes.
24-Jan-2022	7	Added new part number TS3011IYCT in Table 9. Order codes.

---

## Contents

<b>1</b>	<b>Pin configuration</b> .....	<b>2</b>
<b>2</b>	<b>Absolute maximum ratings and operating conditions</b> .....	<b>3</b>
<b>3</b>	<b>Electrical characteristics</b> .....	<b>4</b>
<b>4</b>	<b>Electrical characteristic curves</b> .....	<b>7</b>
<b>5</b>	<b>Application recommendation</b> .....	<b>10</b>
<b>6</b>	<b>Package information</b> .....	<b>11</b>
<b>6.1</b>	SOT23-5 package information .....	11
<b>6.2</b>	SC70-5 (or SOT323-5) package information .....	12
<b>6.3</b>	DFN8 2x2 mm package information .....	13
<b>7</b>	<b>Ordering information</b> .....	<b>14</b>
	<b>Revision history</b> .....	<b>15</b>



## List of figures

<b>Figure 1.</b>	Pin configuration . . . . .	2
<b>Figure 2.</b>	Current consumption vs. power supply voltage - output low . . . . .	7
<b>Figure 3.</b>	Current consumption vs. power supply voltage - output high . . . . .	7
<b>Figure 4.</b>	Current consumption vs. temperature . . . . .	7
<b>Figure 5.</b>	Output voltage vs. sinking current, output low, $V_{CC} = 2.7\text{ V}$ . . . . .	7
<b>Figure 6.</b>	Output voltage vs. sinking current, output low, $V_{CC} = 5\text{ V}$ . . . . .	7
<b>Figure 7.</b>	Output voltage drop vs. sourcing current, output high, $V_{CC} = 2.7\text{ V}$ . . . . .	7
<b>Figure 8.</b>	Output voltage drop vs. sourcing current, output high, $V_{CC} = 5\text{ V}$ . . . . .	8
<b>Figure 9.</b>	Input offset voltage vs. common mode voltage . . . . .	8
<b>Figure 10.</b>	Input offset voltage vs. temperature . . . . .	8
<b>Figure 11.</b>	Propagation delay vs. common mode voltage with negative transition . . . . .	8
<b>Figure 12.</b>	Propagation delay vs. common mode voltage with positive transition . . . . .	8
<b>Figure 13.</b>	Propagation delay vs. power supply voltage with negative transition . . . . .	8
<b>Figure 14.</b>	Propagation delay vs. power supply voltage with positive transition . . . . .	9
<b>Figure 15.</b>	Propagation delay vs. overdrive with negative transition, $V_{CC} = 2.7\text{ V}$ . . . . .	9
<b>Figure 16.</b>	Propagation delay vs. overdrive with positive transition, $V_{CC} = 2.7\text{ V}$ . . . . .	9
<b>Figure 17.</b>	Propagation delay vs. overdrive with negative transition, $V_{CC} = 5\text{ V}$ . . . . .	9
<b>Figure 18.</b>	Propagation delay vs. overdrive with positive transition, $V_{CC} = 5\text{ V}$ . . . . .	9
<b>Figure 19.</b>	Propagation delay vs. temperature . . . . .	9
<b>Figure 20.</b>	High speed layout recommendation . . . . .	10
<b>Figure 21.</b>	SOT23-5 package outline . . . . .	11
<b>Figure 22.</b>	SC70-5 (or SOT323-5) package outline . . . . .	12
<b>Figure 23.</b>	DFN8 2x2 mm package outline . . . . .	13

## List of tables

<b>Table 1.</b>	Absolute maximum ratings . . . . .	3
<b>Table 2.</b>	Operating conditions . . . . .	3
<b>Table 3.</b>	$V_{CC} = 2.2\text{ V}$ , $V_{ICM} = V_{CC}/2$ , $T_{amb} = 25\text{ °C}$ (unless otherwise specified) . . . . .	4
<b>Table 4.</b>	$V_{CC} = 2.7\text{ V}$ , $V_{ICM} = V_{CC}/2$ , $T_{amb} = 25\text{ °C}$ (unless otherwise specified) . . . . .	5
<b>Table 5.</b>	$V_{CC} = 5\text{ V}$ , $V_{ICM} = V_{CC}/2$ , $T_{amb} = 25\text{ °C}$ (unless otherwise specified) . . . . .	6
<b>Table 6.</b>	SOT23-5 mechanical data . . . . .	11
<b>Table 7.</b>	SC70-5 (or SOT323-5) mechanical data . . . . .	12
<b>Table 8.</b>	DFN8 2x2 mm package mechanical data . . . . .	13
<b>Table 9.</b>	Order codes . . . . .	14
<b>Table 10.</b>	Document revision history . . . . .	15

**IMPORTANT NOTICE – PLEASE READ CAREFULLY**

STMicroelectronics NV and its subsidiaries (“ST”) reserve the right to make changes, corrections, enhancements, modifications, and improvements to ST products and/or to this document at any time without notice. Purchasers should obtain the latest relevant information on ST products before placing orders. ST products are sold pursuant to ST’s terms and conditions of sale in place at the time of order acknowledgement.

Purchasers are solely responsible for the choice, selection, and use of ST products and ST assumes no liability for application assistance or the design of Purchasers’ products.

No license, express or implied, to any intellectual property right is granted by ST herein.

Resale of ST products with provisions different from the information set forth herein shall void any warranty granted by ST for such product.

ST and the ST logo are trademarks of ST. For additional information about ST trademarks, please refer to [www.st.com/trademarks](http://www.st.com/trademarks). All other product or service names are the property of their respective owners.

Information in this document supersedes and replaces information previously supplied in any prior versions of this document.

© 2022 STMicroelectronics – All rights reserved