



## LM6685 Ultra Fast Single Latched Comparator

### General Description

The LM6685 is an ultra fast single voltage comparator manufactured with an advanced high speed bipolar process that makes possible very short propagation delays (2.6 ns) with excellent matching characteristics. The comparator has differential analog inputs and complementary logic outputs compatible with most forms of ECL. The output current capability is adequate for driving terminated 50Ω transmission lines. The low input offsets and short delays make this comparator especially suitable for high speed precision analog to digital processing.

The LM6685 is functionally compatible with AD96685 and SP9685.

### Features

- 2.6 ns Typical Propagation Delay
- Complementary ECL Outputs
- 50Ω Line Driving Capability
- Built-In Latch
- Typical Output Skew 0.2 ns
- Propagation Delay Constant with Overdrive

### Applications

- High-speed analog-to-digital processing
- High-speed window comparator

### Connection Diagrams

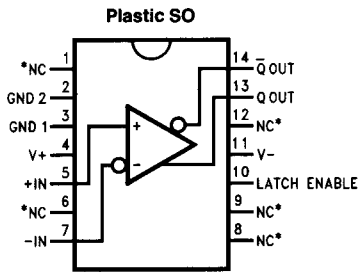

Top View

TL/H/10068-2

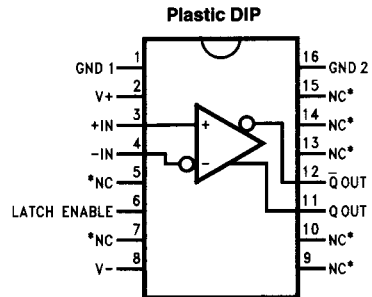

Top View

TL/H/10068-3

\*No connection should be made to pin.

### Ordering Information

| Temperature Range | Package       | NSC Package Number |
|-------------------|---------------|--------------------|
| -30°C to +85°C    |               |                    |
| LM6685IN          | Molded DIP    | N16A               |
| LM6685IM          | Surface Mount | M14A               |

**Absolute Maximum Ratings** (Note 4)

If Military/Aerospace specified devices are required, please contact the National Semiconductor Sales Office/Distributors for availability and specifications.

|  |                              |                 |
|--|------------------------------|-----------------|
| Storage Temperature Range                            | Molded DIP and Surface Mount | -65°C to +150°C |
| Lead Temperature                                     |                              |                 |
| Molded DIP and Surface Mount (Soldering, 10 seconds) |                              | 265°C           |
| Internal Power Dissipation (Note 1)                  |                              |                 |
| 16L-Molded DIP                                       |                              | 1.36W           |
| 14L-Surface Mount                                    |                              | 0.87W           |
| Positive Supply Voltage                              |                              | +7.0V           |
| Negative Supply Voltage                              |                              | -7.0V           |
| Junction Temperature                                 |                              | 150°C           |

|                            |       |
|----------------------------|-------|
| Input Voltage              | ±4.0V |
| Differential Input Voltage | ±6.0V |
| Output Current             | 30 mA |

**Operating Ratings** (Note 4)

|                           |                |
|---------------------------|----------------|
| Temperature Range         |                |
| Industrial                | -30°C to +85°C |
| Positive Supply Voltage   | +6.0V          |
| Negative Supply Voltage   | -5.2V          |
| Minimum Operating Voltage |                |
| $V^+$ to $V^-$            | 9.7V           |
| Thermal Resistance        | (Note 5)       |

**DC Electrical Characteristics** (Note 2)

| Symbol                   | Parameter   | Conditions  | LM6685I |        |        | Units                        |
|--------------------------|---|---|---------|--------|--------|------------------------------|
|                          |   |   | Typ     | Min    | Max    |                              |
| $V_{IO}$                 | Input Offset Voltage                                    | $R_S \leq 100\Omega$ , $T_A = 25^\circ\text{C}$                                 | 0.3     | -1.9   | +1.9   | mV                           |
|                          |   | $R_S \leq 100\Omega$  |         | -2.5   | +2.5   |                              |
| $\Delta V_{IO}/\Delta T$ | Average Temperature Coefficient of Input Offset Voltage | $R_S \leq 100\Omega$  | 1.3     |        |        | $\mu\text{V}/^\circ\text{C}$ |
| $I_{IO}$                 | Input Offset Current                                    | $25^\circ\text{C} \leq T_A \leq T_{A \text{ Max}}$                              | 0.1     | -1.0   | +1.0   | $\mu\text{A}$                |
|                          |   | $T_A = T_{A \text{ Min}}$   | 0.2     | -1.3   | +1.3   |                              |
| $I_{IB}$                 | Input Bias Current                                      | $25^\circ\text{C} \leq T_A \leq T_{A \text{ Max}}$                              | 4.0     |        | 9      | $\mu\text{A}$                |
|                          |   | $T_A = T_{A \text{ Min}}$   | 5.0     |        | 11     |                              |
| $V_{CM}$                 | Common Mode Voltage Range                               |   |         | -3.3   | +3.3   | V                            |
| CMR                      | Common Mode Rejection                                   | $R_S \leq 100\Omega$ , (Note 6)<br>$-3.3\text{V} \leq V_{CM} \leq +3.3\text{V}$ | 106     | 80     |        | dB                           |
| PSRR                     | Power Supply Rejection Ratio                            | $R_S \leq 100\Omega$ , $\Delta V_S = \pm 5\%$<br>(Note 6)                       | 85      | 70     |        | dB                           |
| $V_{OH}$                 | Output Voltage HIGH                                     | $T_A = 25^\circ\text{C}$  | -0.885  | -0.960 | -0.810 | V                            |
|                          |   | $T_A = T_{A \text{ Min}}$   | -0.975  | -1.060 | -0.890 |                              |
|                          |   | $T_A = T_{A \text{ Max}}$   | -0.795  | -0.890 | -0.700 |                              |
| $V_{OL}$                 | Output Voltage LOW                                      | $T_A = 25^\circ\text{C}$  | -1.750  | -1.850 | -1.650 | V                            |
|                          |   | $T_A = T_{A \text{ Min}}$   | -1.783  | -1.890 | -1.675 |                              |
|                          |   | $T_A = T_{A \text{ Max}}$   | -1.725  | -1.825 | -1.625 |                              |
| $I_+$                    | Positive Supply Current                                 |   | 15      |        | 19     | mA                           |
| $I_-$                    | Negative Supply Current                                 |   | 17      |        | 23     | mA                           |
| $P_c$                    | Power Consumption                                       |   | 200     |        | 270    | mW                           |

## Switching Characteristics $V_{IN} = 100\text{ mV}$ with overdrive, $V_{OD} = 10\text{ mV}$ (Notes 2, 3)

| Symbol                   | Parameter                                    | Conditions               | LM6685I |     |     | Units |
|--------------------------|--|--------------------------|---------|-----|-----|-------|
|                          |  |                          | Typ     | Min | Max |       |
| $t_{PD+}, t_{PD-}$       | Propagation Delay                            | $T_A = 25^\circ\text{C}$ | 2.6     |     | 3.5 | ns    |
| $t_{PD+}(E), t_{PD-}(E)$ | Latch Enable to Output (HIGH or LOW) Display | $T_A = 25^\circ\text{C}$ | 2.0     |     | 2.5 | ns    |
| $t_S$                    | Min Latch Set up Time                        | $T_A = 25^\circ\text{C}$ | 0.5     |     | 1.0 | ns    |
| $t_H$                    | Min Latch Hold Time                          | $T_A = 25^\circ\text{C}$ | 0.5     |     | 1.0 | ns    |

**Note 1:** Ratings apply to ambient temperature at  $25^\circ\text{C}$ .

**Note 2:** Unless otherwise specified  $V_+ = 6.0\text{V}$ ,  $V_- = -5.2\text{V}$ ,  $R_L = 50\Omega$  to termination voltage  $V_T = -2.0\text{V}$ ; all switching characteristics are for a  $100\text{ mV}$  input step with  $10\text{ mV}$  overdrive. The specification given for  $V_{IO}$ ,  $I_{IO}$ ,  $I_B$ ,  $\text{CMR}$ ,  $\text{PSRR}$ , apply for  $\pm 5\%$  supply voltage tolerances.  $T_A = T_J$ .

**Note 3:** Guaranteed but not tested in production.

**Note 4:** Absolute Maximum Ratings indicate limits beyond which damage to the device may occur. Operating Ratings indicate conditions for which the device is intended to be functional, but do not guarantee specific performance limits. For guaranteed specifications and test conditions, see the Electrical Characteristics. The guaranteed specifications apply only for the last conditions tested.

**Note 5:** The junction-to-ambient thermal resistance of the plastic molded DIP (N) is  $92^\circ\text{C}/\text{W}$  and the molded plastic SO(M) package is  $144^\circ\text{C}/\text{W}$ . All numbers apply for packages soldered directly into a PC board.

**Note 6:** Limit applies for  $25^\circ\text{C}$  only.

## Equivalent Circuit

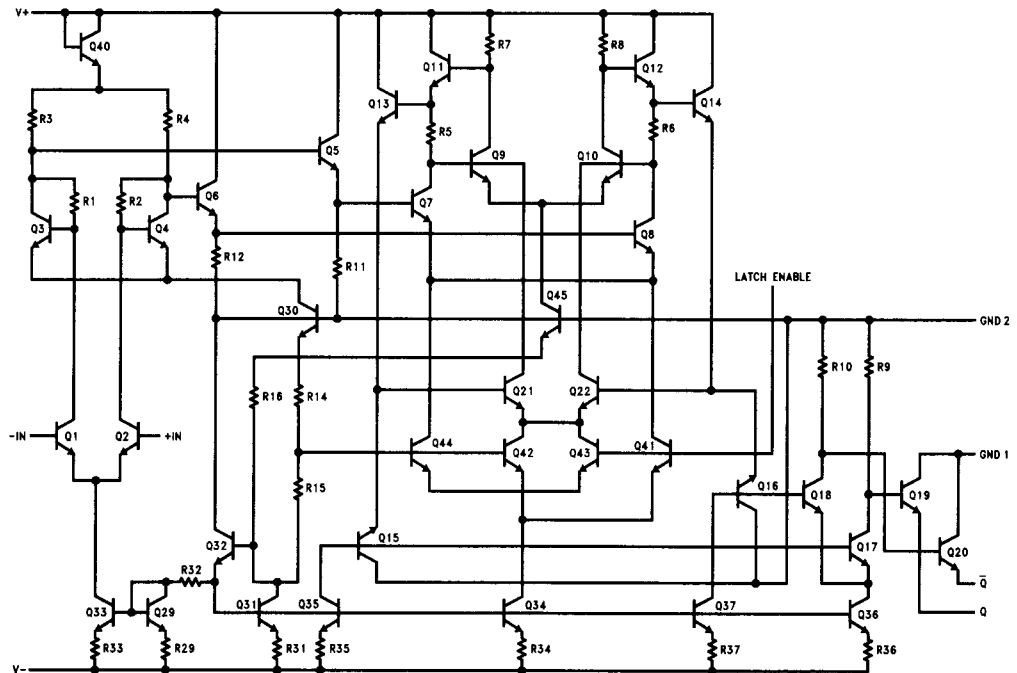

TL/H/10068-4

**Typical Performance Characteristics**  $T_A = 25^\circ\text{C}$ ,  $V_+ = 6.0\text{V}$ ,  $V_- = -5.2\text{V}$ ,  $V_T = -2.0\text{V}$ ,  $R_L = 50\Omega$  and switching characteristics are for  $V_{IN} = 100\text{mV}$ ,  $V_{OD} = 10\text{mV}$ , unless otherwise specified

**Propagation Delay vs Load Resistance**

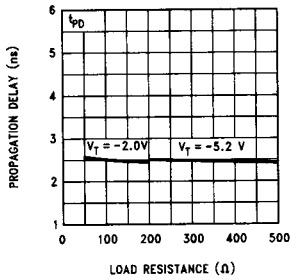

**Propagation Delay vs Negative Supply Voltage**

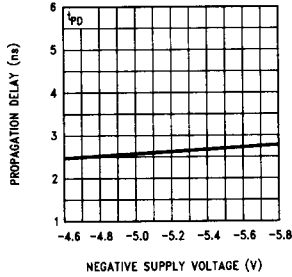

**Propagation Delay vs Common Mode Voltage**

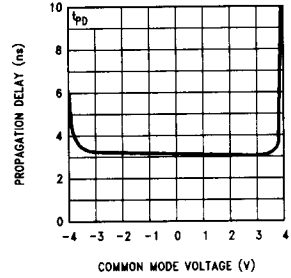

**Response to 100 MHz Sine Wave**

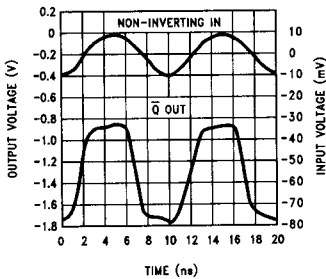

**Common Mode Limits vs Temperature**

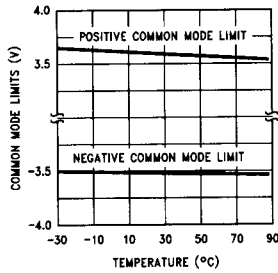

**Negative Common Mode Limit vs Negative Supply Voltage**

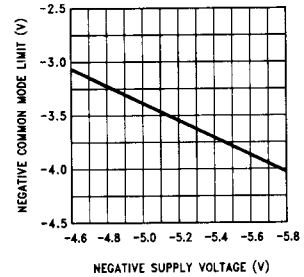

**Positive Common Mode Limit vs Positive Supply Voltage**

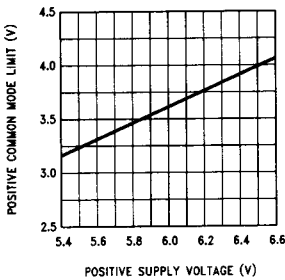

**Output Levels vs Temperature**

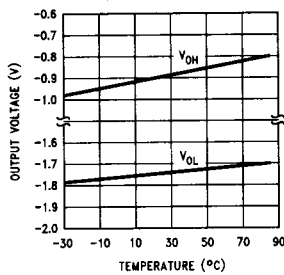

**Output Levels vs Negative Supply Voltage**

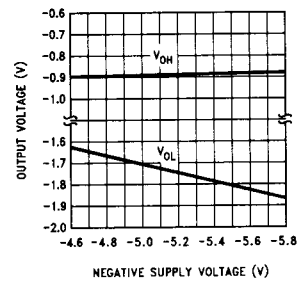

TL/H/10068-5

**Typical Performance Characteristics**  $T_A = 25^\circ\text{C}$ ,  $V_+ = 6.0\text{V}$ ,  $V_- = -5.2\text{V}$ ,  $V_T = -2.0\text{V}$ ,  $R_L = 50\Omega$  and switching characteristics are for  $V_{IN} = 100\text{mV}$ ,  $V_{OD} = 10\text{mV}$ , unless otherwise specified (Continued)

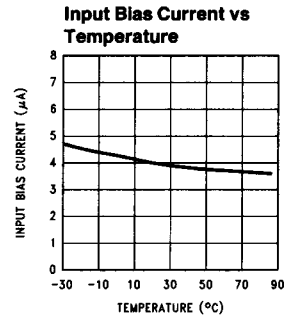
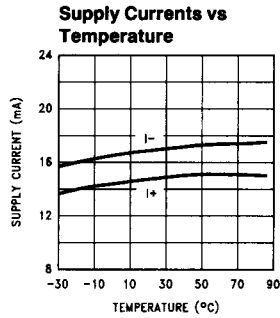
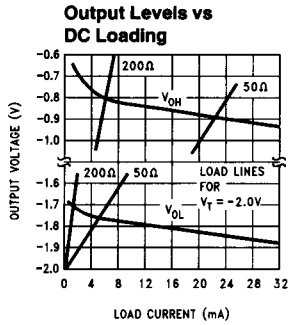

TL/H/10068-6

## Typical Applications (T<sub>A</sub> = 25°C)

### High Speed Window Detector

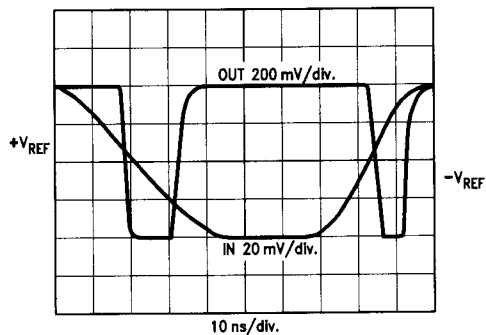
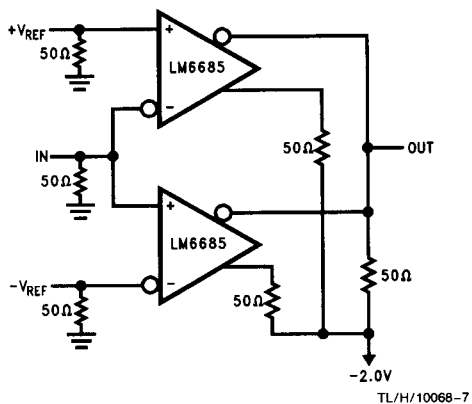

### High Speed Sampling

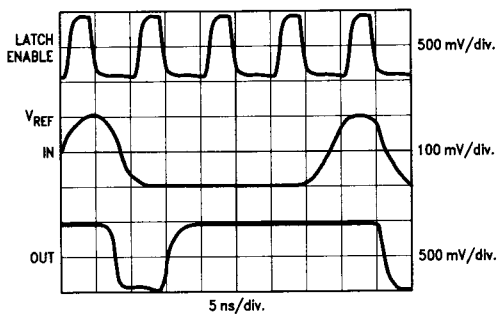
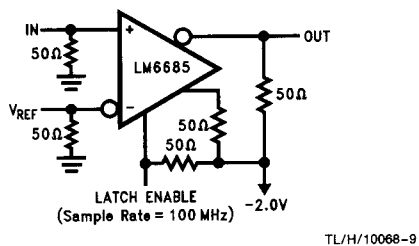

## Application Information

Propagation Delay Test Circuit

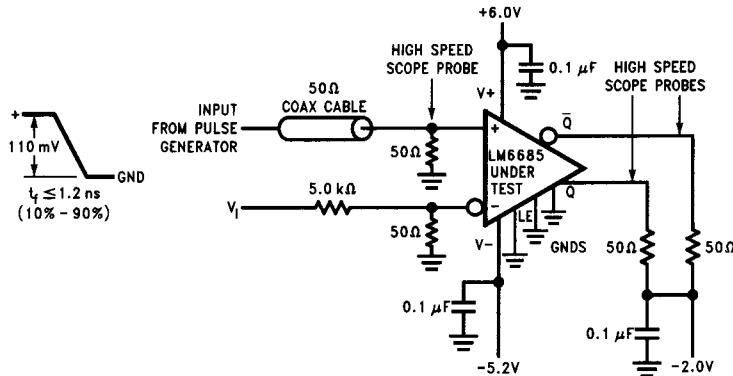

TL/H/10068-11

### Measurement of Propagation Delay

Propagation delays  $t_{PD} +$  ( $\bar{Q}$  output) and  $t_{PD} -$  (Q output) are measured with input signal conditions of a 100 mV step with an overdrive of 10 mV (the overdrive is the voltage in excess of that needed to bring the output to the center of its dynamic range). Offset is compensated for by adjusting  $V_1$  until outputs are in the linear region while the Pulse Generator is disconnected.  $V_1$  is then increased in the positive direction so inverting input changes by 10 mV, i.e. the overdrive condition. Propagation delays are then measured with actual input pulse condition of +110 mV to 0V swing, with a  $t_{PD} +$  or  $t_{PD} -$  reading taken between the +10 mV level of the input pulse and the 50% point of the outputs.

### Thermal Considerations

To achieve the high speed of the LM6685, a certain amount of power must be dissipated as heat. This increases the temperature of the die relative to the ambient temperature. In order to be compatible with ECL III and ECL 10,000, which normally use air flow as a means of package cooling, the device must have an air flow across the package of 500 linear feet per minute or greater. Thus, even though different ECL circuits on a printed circuit board may have different power dissipations, all will have the same input and output levels, etc. provided each sees the same air flow and air temperature. This eases design, since the only change in characteristics between devices is due to the increase in

ambient temperature of the air passing over the devices. If the LM6685 is operated without air flow, the change in electrical characteristics due to the increased die temperature must be taken into account.

### Interconnection Techniques

All high speed ECL circuits require that special precautions be taken for optimum system performance. The LM6685 is particularly critical because it features very high gain (60 dB) at very high frequencies (100 MHz). A ground plane must be provided for a good, low inductance, ground current return path. The impedance at the inputs should be as low as possible and lead lengths as short as practical. It is preferable to solder the device directly to the printed circuit board instead of using a socket. Open wiring on the outputs should be limited to less than one inch, since severe ringing occurs beyond this length. For longer lengths, the printed circuit interconnections become microstrip transmission lines when backed up by a ground plane, with a characteristic impedance of 50 to 150 Ω. Reflections will occur unless the line is terminated in its characteristic impedance. The termination resistors normally go to -2.0V, but a Thevenin equivalent to  $V_-$  can be used at some increase in power. Best results are usually obtained with the terminating resistor at the end of the driven line. The lower impedance lines are more suitable for driving capacitive loads. The supply voltages should be decoupled with RF capacitors connected to the ground plane as close to the device supply leads as possible.

# Timing Diagram

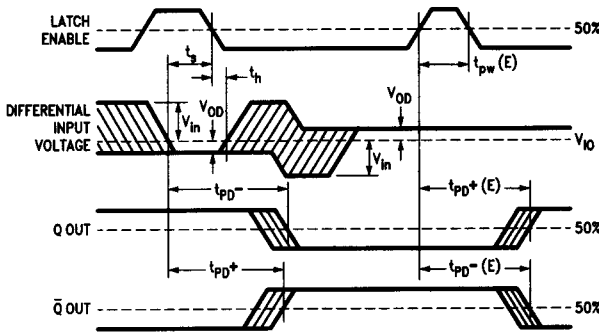

TL/H/10068-12

## Key to Timing Diagram

| WAVEFORM | INPUTS                 | OUTPUTS                      |
|----------|------------------------|------------------------------|
|          | MUST BE STEADY         | WILL BE STEADY               |
|          | MAY CHANGE FROM H TO L | WILL BE CHANGING FROM H TO L |
|          | MAY CHANGE FROM L TO H | WILL BE CHANGING FROM L TO H |

TL/H/10068-13

**Note:** The setup and hold times are a measure of the time required for an input signal to propagate through the first stage of the comparator to reach the latching circuitry. Input signal changes occurring before  $t_s$  will be detected and held; those occurring after  $t_h$  will not be detected. Changes between  $t_s$  and  $t_h$  may or may not be detected.

## Definition of Terms

- $V_{IO}$  **Input Offset Voltage**—That voltage which must be applied between the two input terminals through two equal resistances to obtain zero voltage between the two outputs.
- $\Delta V_{IO}/\Delta T$  **Average Temperature Coefficient of Input Offset Voltage**—The ratio of the change in input offset voltage over the operating temperature range to the temperature range.
- $I_{IO}$  **Input Offset Current**—The difference between the currents into the two input terminals when there is zero voltage between the two outputs.
- $I_{IB}$  **Input Bias Current**—The average of the two input currents.
- $R_i$  **Input Resistance**—The resistance looking into either input terminal with the other grounded.
- $C_i$  **Input Capacitance**—The capacitance looking into either input terminal with other grounded.
- $V_{CM}$  **Common Mode Voltage Range**—The range of voltages on the input terminals for which the offset and propagation delay specifications apply.

- CMR **Common Mode Rejection**—The ratio of the input voltage range to the peak-to-peak change in input offset voltage over this range.
- PSRR **Power Supply Rejection Ratio**—The ratio of the change in input offset voltage to the change in power supply voltages producing it.
- $V_{OH}$  **Output Voltage HIGH**—The logic HIGH output voltage with an external pull-down resistor returned to a negative supply.
- $V_{OL}$  **Output Voltage LOW**—The logic LOW output voltage with an external pull-down resistor returned to a negative supply.
- $I_+$  **Positive Supply Current**—The current required from the positive supply to operate the comparator.
- $I_-$  **Negative Supply Current**—The current required from the negative supply to operate the comparator.
- $P_c$  **Power Consumption**—The power dissipated by the comparator with both outputs terminated in  $50\Omega$  to  $-2.0V$ .



## Switching Terms (see Timing Diagram)

|              |   |
|--------------|---|
| $t_{PD+}$    | <b>Input to Output HIGH Delay</b> —The propagation delay measured from the time the input signal crosses the input offset voltage to the 50% point of an output LOW to HIGH transition.             |
| $t_{PD-}$    | <b>Input to Output LOW Delay</b> —The propagation delay measured from the time the input signal crosses the input offset voltage to the 50% point of an output HIGH to LOW transition.              |
| $t_{PD+(E)}$ | <b>Latch Enable to Output HIGH Delay</b> —The propagation delay measured from the 50% point of the Latch Enable signal LOW to HIGH transition to the 50% point of an output LOW to HIGH transition. |
| $t_{PD-(E)}$ | <b>Latch Enable to Output LOW Delay</b> —The propagation delay measured from the 50% point of the Latch Enable signal HIGH to LOW transition to the 50% point of an output HIGH to LOW transition.  |
| $t_S$        | <b>Minimum Setup Time</b> —The minimum time before the negative transition of the Latch Enable signal that an input signal change must be present in order to be acquired and held at the outputs.  |

|             |  |
|-------------|--|
| $t_H$       | <b>Minimum Hold Time</b> —The minimum time after the negative transition of the Latch Enable signal that the input signal must remain unchanged in order to be acquired and held at the outputs. |
| $t_{pw(E)}$ | <b>Minimum Latch Enable Pulse Width</b> —The minimum time that the Latch Enable signal must be HIGH in order to acquire and hold an input signal change.   |

## Other Symbols

|          |                                 |
|----------|---------------------------------|
| $T_A$    | Ambient temperature             |
| $R_S$    | Input source resistance         |
| $V_{CC}$ | Supply voltages                 |
| $V_+$    | Positive supply voltage         |
| $V_-$    | Negative supply voltage         |
| $V_T$    | Output load terminating voltage |
| $R_L$    | Output load resistance          |
| $V_{IN}$ | Input pulse amplitude           |
| $V_{OD}$ | Input overdrive                 |
| $f$      | Frequency                       |