

Micropower quad CMOS voltage comparators

Datasheet - production data



Related products

- Pin-to-pin and functionally compatible with the dual CMOS TS3704 comparators
- See TSX339 for open drain output

Applications

- Automotive
- Industrial

Description

The TSX3704 is a micropower CMOS quad voltage comparator which exhibits a very low current consumption of 5 μ A typical per comparator. This device was designed as the improvement of the TS3704: it shows a lower current consumption, a better input offset voltage, and an enhanced ESD tolerance. The TSX3704 is fully specified over a wide temperature range and is proposed in automotive grade for the TSSOP14 package. It is fully compatible with the TS3704 CMOS comparator and is available with similar packages. The new tiny package, QFN16 3x3, is also proposed for the TSX3704 thus allowing even more integration on applications.

Features

- Low supply current: 5 μ A typ. per comparator
- Wide single supply range 2.7 V to 16 V or dual supplies (± 1.35 V to ± 8 V)
- Extremely low input bias current: 1 pA typ.
- Input common-mode voltage range includes ground
- Push-pull output
- High input impedance: 10^{12} Ω typ
- Fast response time: 2.7 μ s typ. for 5 mV overdrive
- ESD tolerance: 4 kV HBM, 200 V MM

Contents

1 Schematic diagram..... 3

2 Package pin connections..... 4

3 Absolute maximum ratings and operating conditions 5

4 Electrical characteristics 6

5 Electrical characteristic curves 10

6 Application information 13

 6.1 Input voltages..... 13

 6.2 For unused channel 14

 6.3 Bypass capacitor..... 14

7 Package information 15

 7.1 SO14 package information..... 16

 7.2 TSSOP14 package information..... 17

 7.3 QFN16 3x3 package information..... 18

8 Ordering information..... 20

9 Revision history 21

1 Schematic diagram

Figure 1: Schematic diagram (one operator)



2 Package pin connections

Figure 2: Pin connections (top view)

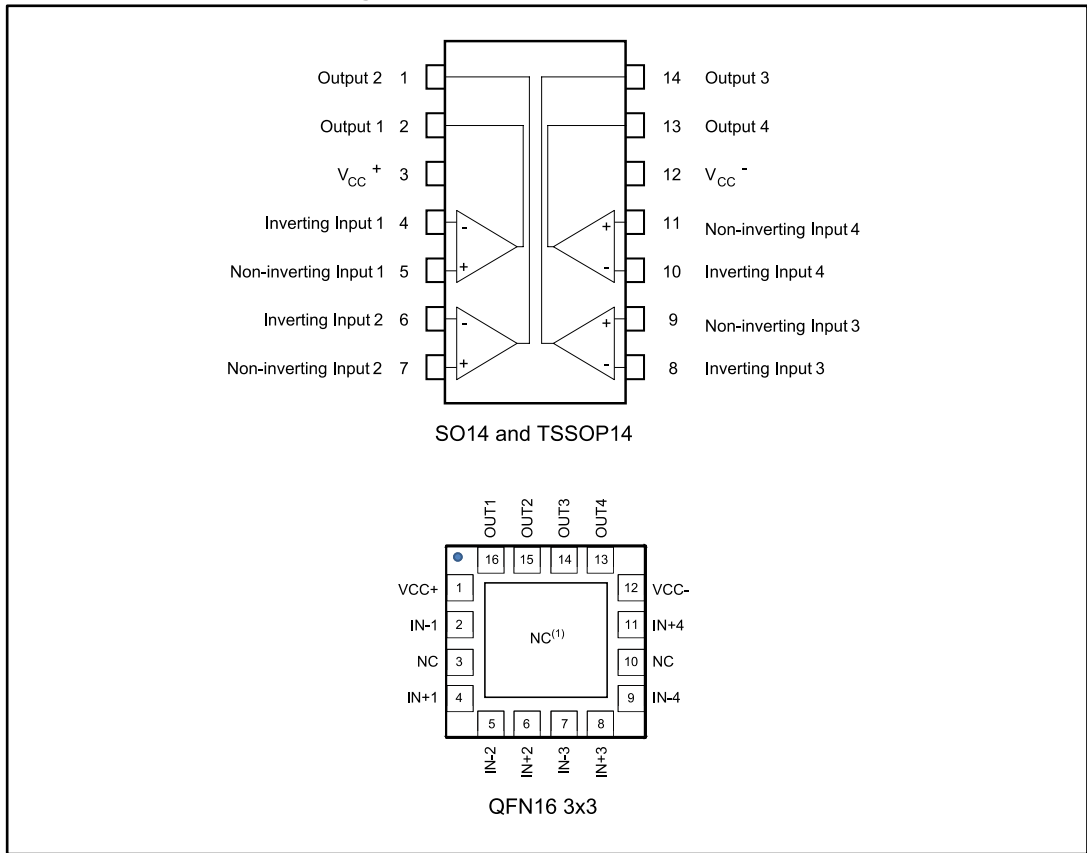

1. NC = not connected
2. The exposed pad of the QFN16 3x3 can be connected to VCC- or left floating.

3 Absolute maximum ratings and operating conditions

Table 1: Absolute maximum ratings (AMR)

Symbol	Parameter	Value	Unit	
V_{CC}^+	Supply voltage ⁽¹⁾	18	V	
V_{id}	Differential input voltage ⁽²⁾	±18		
V_{in}	Input voltage	-0.3 to 18		
V_o	Output voltage	18		
I_o	Output current	20	mA	
I_F	Forward current in ESD protection diodes on inputs ⁽³⁾	50		
T_j	Maximum junction temperature	150	°C	
T_{stg}	Storage temperature range	-65 to 150		
R_{thja}	Thermal resistance junction to ambient ⁽⁴⁾	SO14	105	°C/W
		TSSOP14	100	
		QFN16 3x3	39	
ESD	HBM: human body model ⁽⁵⁾	4000	V	
	MM: machine model ⁽⁶⁾	200		
	CDM: charged device model ⁽⁷⁾	1500		
	Latch-up immunity	200	mA	

Notes:

- ⁽¹⁾All voltage values, except the differential voltage, are with respect to network ground terminal
- ⁽²⁾Differential voltages are the non-inverting input terminal with respect to the inverting input terminal
- ⁽³⁾Guaranteed by design
- ⁽⁴⁾Short-circuits can cause excessive heating and destructive dissipation. Values are typical
- ⁽⁵⁾According to JEDEC standard JESD22-A114F
- ⁽⁶⁾According to JEDEC standard JESD22-A115A
- ⁽⁷⁾According to ANSI/ESD STM5.3.1

Table 2: Operating conditions

Symbol	Parameter	Value	Unit
V_{CC}^+	Supply voltage	2.7 to 16	V
$V_{icm}^{(1)}$	Common mode input voltage range	0 to $(V_{CC}^+) - 1.5$	
	$T_{min} \leq T_{amb} \leq T_{max}$	0 to $(V_{CC}^+) - 2$	
T_{oper}	Operating free-air temperature range	-40 to 125	°C

Notes:

- ⁽¹⁾The output state is guaranteed as long as one input remains with this common mode input voltage range, and the other input remains between -0.3 V and 16 V (meaning that one input can be driven above V_{CC}^+).

4 Electrical characteristics

Table 3: $V_{CC+} = 3\text{ V}$, $V_{CC-} = 0\text{ V}$, $T_{amb} = 25\text{ }^{\circ}\text{C}$ (unless otherwise specified)

Symbol	Parameter	Condition	Min.	Typ.	Max.	Unit
V_{io}	Input offset voltage ⁽¹⁾	$V_{icm} = 0\text{ V}$	-5	0.1	5	mV
		$T_{min} \leq T_{amb} \leq T_{max}$	-6		6	
I_{io}	Input offset current ⁽²⁾	$V_{icm} = V_{CC}/2$		1	10	pA
		$T_{min} \leq T_{amb} \leq T_{max}$			600	
I_{ib}	Input bias current ⁽²⁾	$V_{icm} = V_{CC}/2$		1	10	
		$T_{min} \leq T_{amb} \leq T_{max}$			1200	
CMR	Common-mode rejection ratio	$V_{icm} = 0\text{ to max } V_{icm}$	58	73		dB
		$T_{min} \leq T_{amb} \leq T_{max}$	55			
SVR	Supply voltage rejection ratio	$V_{CC+} = 3\text{ V to } 5\text{ V}$, $V_{icm} = V_{CC}/2$	69	88		
		$T_{min} \leq T_{amb} \leq T_{max}$	69			
V_{OH}	High-level output voltage drop	$V_{id} = 1\text{ V}$, $I_{OH} = 4\text{ mA}$		300	400	mV
		$T_{min} \leq T_{amb} \leq T_{max}$			600	
V_{OL}	Low-level output voltage	$V_{id} = -1\text{ V}$, $I_{OL} = 4\text{ mA}$		300	400	mV
		$T_{min} \leq T_{amb} \leq T_{max}$			600	
I_{CC}	Supply current per comparator	No load - outputs low		5	6	μA
		$T_{min} \leq T_{amb} \leq T_{max}$			7	
		No load - outputs high		8	9	
		$T_{min} \leq T_{amb} \leq T_{max}$			11	
t_{PLH}	Response time low to high	$V_{icm} = 0\text{ V}$, $f = 10\text{ kHz}$, $R_L = 5.1\text{ k}\Omega$, $C_L = 50\text{ pF}$, overdrive = 5 mV		2.4		μs
		Overdrive = 100 mV		0.5	0.6	
		$T_{min} \leq T_{amb} \leq T_{max}$			0.77	
t_{PHL}	Response time high to low	$V_{icm} = 0\text{ V}$, $f = 10\text{ kHz}$, $R_L = 5.1\text{ k}\Omega$, $C_L = 50\text{ pF}$, overdrive = 5 mV		2		μs
		Overdrive = 100 mV		0.45	0.6	
		$T_{min} \leq T_{amb} \leq T_{max}$			0.65	
t_r	Rise time	$f = 10\text{ kHz}$, $C_L = 50\text{ pF}$, $R_L = 5.1\text{ k}\Omega$, overdrive 50 mV		39		ns
t_f	Fall time	$f = 10\text{ kHz}$, $C_L = 50\text{ pF}$, $R_L = 5.1\text{ k}\Omega$, overdrive 50 mV		39		

Notes:

⁽¹⁾The specified offset voltage is the maximum value required to drive the output up to 2.5 V or down to 0.3 V.

⁽²⁾Guaranteed by design.

Table 4: VCC+ = 5 V, VCC- = 0 V, Tamb = 25 °C (unless otherwise specified)

Symbol	Parameter	Condition	Min.	Typ.	Max.	Unit
V _{io}	Input offset voltage ⁽¹⁾	V _{icm} = V _{CC} /2	-5	0.1	5	mV
		T _{min} ≤ T _{amb} ≤ T _{max}	-6		6	
I _{io}	Input offset current ⁽²⁾	V _{icm} = V _{CC} /2		1	10	pA
		T _{min} ≤ T _{amb} ≤ T _{max}			600	
I _{ib}	Input bias current ⁽²⁾	V _{icm} = V _{CC} /2		1	10	
		T _{min} ≤ T _{amb} ≤ T _{max}			1200	
CMR	Common-mode rejection ratio	V _{icm} = 0 to max V _{icm}	66	85		dB
		T _{min} ≤ T _{amb} ≤ T _{max}	65			
SVR	Supply voltage rejection ratio	V _{CC} ⁺ = 5 V to 10 V, V _{icm} = V _{CC} /2	71	89		
		T _{min} ≤ T _{amb} ≤ T _{max}	70			
V _{OH}	High-level output voltage drop	V _{id} = 1 V, I _{OH} = 4 mA		180	250	mV
		T _{min} ≤ T _{amb} ≤ T _{max}			400	
V _{OL}	Low-level output voltage	V _{id} = -1 V, I _{OL} = 4 mA		180	250	
		T _{min} ≤ T _{amb} ≤ T _{max}			400	
I _{CC}	Supply current per comparator	No load - outputs low		5	8	μA
		T _{min} ≤ T _{amb} ≤ T _{max}			9	
		No load - outputs high		9	10	
		T _{min} ≤ T _{amb} ≤ T _{max}			11	
t _{PLH}	Response time low to high	V _{icm} = 0 V, f = 10 kHz, R _L = 5.1 kΩ, C _L = 50 pF, overdrive = 5 mV		2.4		μs
		Overdrive = 10 mV		1.5		
		Overdrive = 20 mV		0.9		
		Overdrive = 40 mV		0.6		
		Overdrive = 100 mV		0.35	0.55	
		T _{min} ≤ T _{amb} ≤ T _{max}			0.6	
		TTL input ⁽³⁾		0.45	0.6	
		T _{min} ≤ T _{amb} ≤ T _{max}			0.65	
t _{PHL}	Response time high to low	V _{icm} = 0 V, f = 10 kHz, R _L = 5.1 kΩ, C _L = 50 pF, overdrive = 5 mV		2.8		μs
		Overdrive = 10 mV		1.8		
		Overdrive = 20 mV		1		
		Overdrive = 40 mV		0.7		
		Overdrive = 100 mV		0.46	0.6	
		T _{min} ≤ T _{amb} ≤ T _{max}			0.7	
		TTL input ⁽³⁾		0.3	0.4	
		T _{min} ≤ T _{amb} ≤ T _{max}			0.5	
t _r	Rise time	f = 10 kHz, C _L = 50 pF, R _L = 5.1 kΩ, overdrive 50 mV		30		ns
t _f	Fall time	f = 10 kHz, C _L = 50 pF, R _L = 5.1 kΩ, overdrive 50 mV		30		

Notes:

- ⁽¹⁾The specified offset voltage is the maximum value required to drive the output up to 2.5 V or down to 0.3 V.
- ⁽²⁾Guaranteed by design.
- ⁽³⁾A step from 0 V to 3 V is applied on one input while the other is fixed at 1.4 V. The response time is the time interval between the application of the input voltage step and the moment the output voltage reaches 50 % of its final value.

Table 5: $V_{CC+} = 16\text{ V}$, $V_{CC-} = 0\text{ V}$, $T_{amb} = 25\text{ }^{\circ}\text{C}$ (unless otherwise specified)

Symbol	Parameter	Condition	Min.	Typ.	Max.	Unit
V_{io}	Input offset voltage ⁽¹⁾	$V_{icm} = V_{CC}/2$	-5	0.1	5	mV
		$T_{min} \leq T_{amb} \leq T_{max}$	-6		6	
I_{io}	Input offset current ⁽²⁾	$V_{icm} = V_{CC}/2$		1	10	pA
		$T_{min} \leq T_{amb} \leq T_{max}$			600	
I_{ib}	Input bias current ⁽²⁾	$V_{icm} = V_{CC}/2$		1	10	
		$T_{min} \leq T_{amb} \leq T_{max}$			1200	
CMR	Common-mode rejection ratio	$V_{icm} = 0$ to $\max V_{icm}$	72	90		dB
		$T_{min} \leq T_{amb} \leq T_{max}$	70			
SVR	Supply voltage rejection ratio	$V_{CC}^+ = 5\text{ V}$ to 16 V , $V_{icm} = V_{CC}/2$	73	90		
		$T_{min} \leq T_{amb} \leq T_{max}$	72			
V_{OH}	High level output voltage drop	$V_{id} = 1\text{ V}$, $I_{OH} = 4\text{ mA}$		90	150	mV
		$T_{min} \leq T_{amb} \leq T_{max}$			250	
V_{OL}	Low level output voltage	$V_{id} = -1\text{ V}$, $I_{OL} = 4\text{ mA}$		90	150	
		$T_{min} \leq T_{amb} \leq T_{max}$			250	
I_{CC}	Supply current per comparator	No load - outputs low		7	9	μA
		$T_{min} \leq T_{amb} \leq T_{max}$			10	
		No load - outputs high		11	13	
		$T_{min} \leq T_{amb} \leq T_{max}$			14	
t_{PLH}	Response time low to high	$V_{icm} = 0\text{ V}$, $f = 10\text{ kHz}$, $R_L = 5.1\text{ k}\Omega$, $C_L = 50\text{ pF}$, overdrive = 5 mV		2.2		μs
		Overdrive = 10 mV		1.4		
		Overdrive = 20 mV		0.9		
		Overdrive = 40 mV		0.6		
		Overdrive = 100 mV		0.34	0.55	
		$T_{min} \leq T_{amb} \leq T_{max}$			0.6	
t_{PHL}	Response time high to low	$V_{icm} = 0\text{ V}$, $f = 10\text{ kHz}$, $R_L = 5.1\text{ k}\Omega$, $C_L = 50\text{ pF}$, overdrive = 5 mV		2.4		μs
		Overdrive = 10 mV		1.6		
		Overdrive = 20 mV		1		
		Overdrive = 40 mV		0.7		
		Overdrive = 100 mV		0.55	0.7	
		$T_{min} \leq T_{amb} \leq T_{max}$			0.75	
t_r	Rise time	$f = 10\text{ kHz}$, $C_L = 50\text{ pF}$, $R_L = 5.1\text{ k}\Omega$, overdrive 50 mV		11		ns
t_f	Fall time	$f = 10\text{ kHz}$, $C_L = 50\text{ pF}$, $R_L = 5.1\text{ k}\Omega$, overdrive 50 mV		11		

Notes:

⁽¹⁾The specified offset voltage is the maximum value required to drive the output up to 2.5 V or down to 0.3 V .

⁽²⁾Guaranteed by design.

5 Electrical characteristic curves

Figure 3: Current consumption vs. supply voltage, output high



Figure 4: Current consumption vs. supply voltage, output low



Figure 5: Current consumption vs. input common-mode voltage, output high



Figure 6: Current consumption vs. common-mode voltage, output low

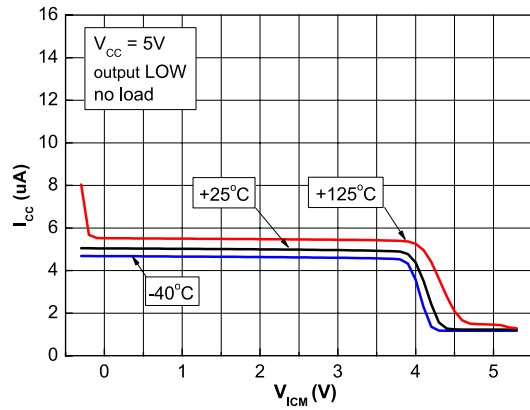

Figure 7: Output voltage drop vs. output source current, VCC = 5 V

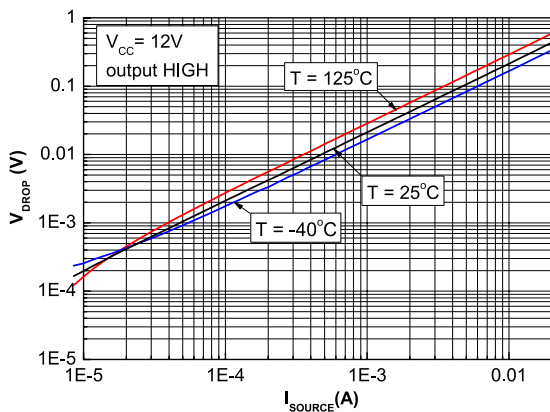

Figure 8: Output voltage drop vs. output source current, VCC = 12 V

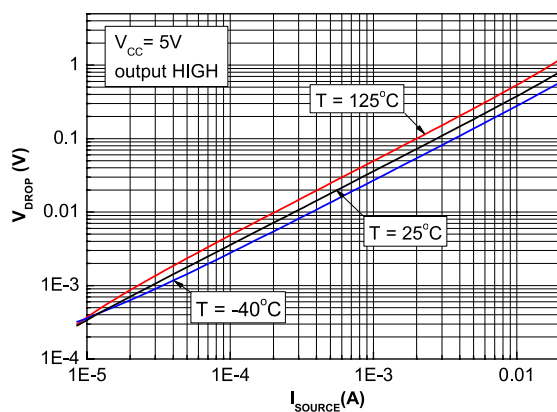

Figure 9: Output voltage drop vs. output sink current, VCC = 5 V

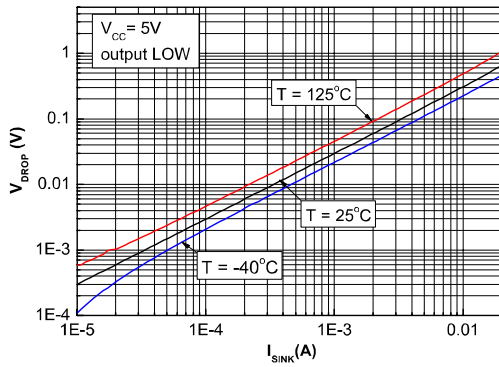

Figure 10: Output voltage drop vs. output sink current, VCC = 12 V



Figure 11: Input offset voltage distribution, VCC = 5 V

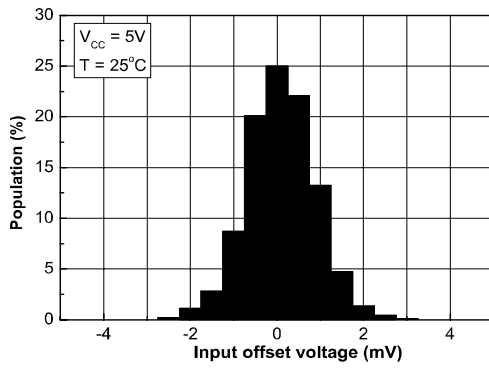

Figure 12: Input current vs input voltage, VCC = 5 V

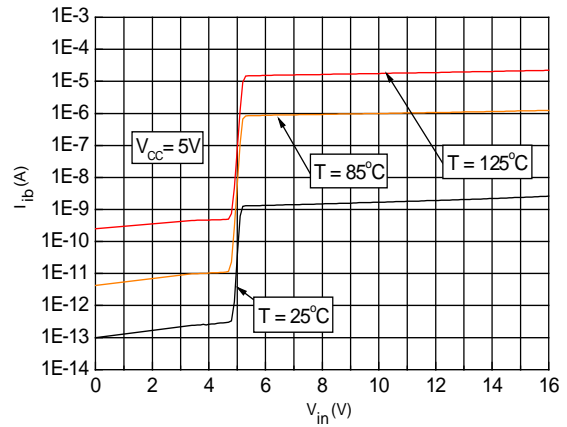

Figure 13: Propagation delay tPLH vs. input signal overdrive, VCC = 5 V

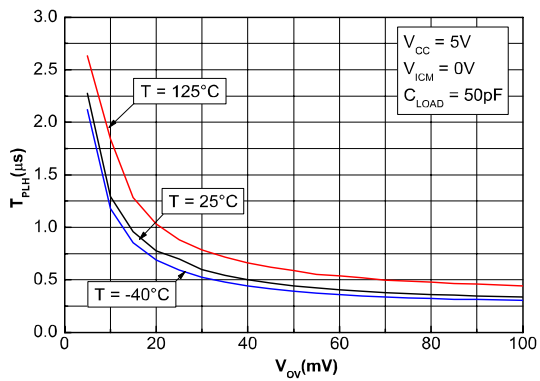

Figure 14: Propagation delay tPHL vs. input signal overdrive, VCC = 5 V

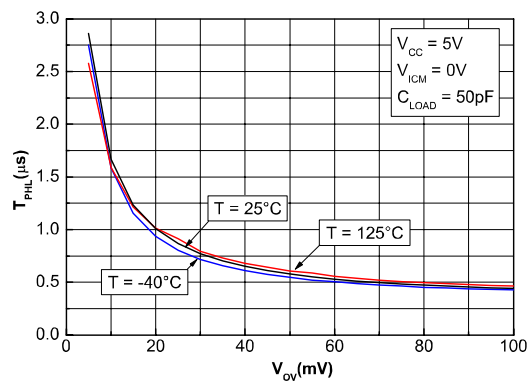

Figure 15: Propagation delay tPLH vs. supply voltage

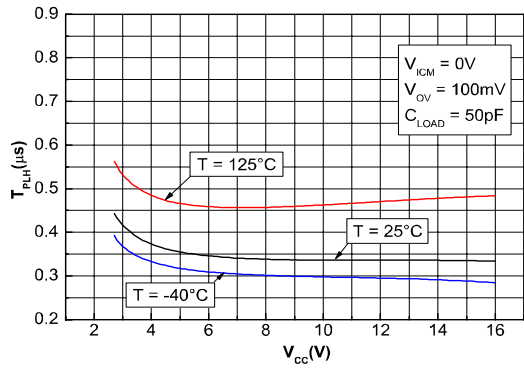
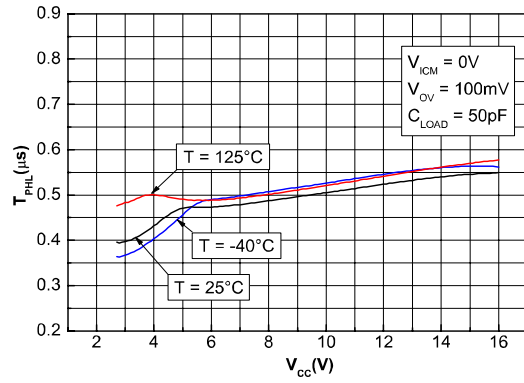

Figure 16: Propagation delay tPHL vs. supply voltage



6 Application information

6.1 Input voltages

The output state is guaranteed as long as one input remains within the common mode input voltage range (defined in the operating conditions table), and the other input remains between -0.3 V and 16 V (meaning that one input can be driven above VCC+).

If one input voltage is beyond the range 0 V to 16 V, this input of the comparator should be protected according to [Figure 17](#).

If the input is lower than Vcc-, a significant current may go through the ESD diode. To protect the circuit, this current must be limited to 10 mA by using the Rg+ or Rg- resistors.

If the input is bigger than 16 V, it has to be voltage limited. This is achieved using the D- or D+ additional, external diodes. To protect these diodes, the current is limited using the Rg resistor. D- and D+ diodes can be connected to another power supply with a maximum value of 16 V. The device is designed to prevent phase reversal.

Figure 17: Additional, external, protection schematic



6.2 For unused channel

An unused comparator has to be configured to avoid unexpected additional consumption. A simple solution is to connect the input to the power supply pins as shown in [Figure 18](#). This keeps the circuit in a stable state.

Figure 18: Input configuration for unused channel



6.3 Bypass capacitor

To maintain proper coupling of the power supply, it is strongly recommended to place a 0.1 μF capacitor as close as possible to the supply pins.

7 Package information

In order to meet environmental requirements, ST offers these devices in different grades of ECOPACK[®] packages, depending on their level of environmental compliance. ECOPACK[®] specifications, grade definitions and product status are available at: www.st.com. ECOPACK[®] is an ST trademark.

7.1 SO14 package information

Figure 19: SO14 package outline



Table 6: SO14 mechanical data

Ref.	Dimensions					
	Millimeters			Inches		
	Min.	Typ.	Max.	Min.	Typ.	Max.
A	1.35		1.75	0.05		0.068
A1	0.10		0.25	0.004		0.009
A2	1.10		1.65	0.04		0.06
B	0.33		0.51	0.01		0.02
C	0.19		0.25	0.007		0.009
D	8.55		8.75	0.33		0.34
E	3.80		4.0	0.15		0.15
e		1.27			0.05	
H	5.80		6.20	0.22		0.24
h	0.25		0.50	0.009		0.02
L	0.40		1.27	0.015		0.05
k	8° (max)					
ddd			0.10			0.004

7.2 TSSOP14 package information

Figure 20: TSSOP14 package outline

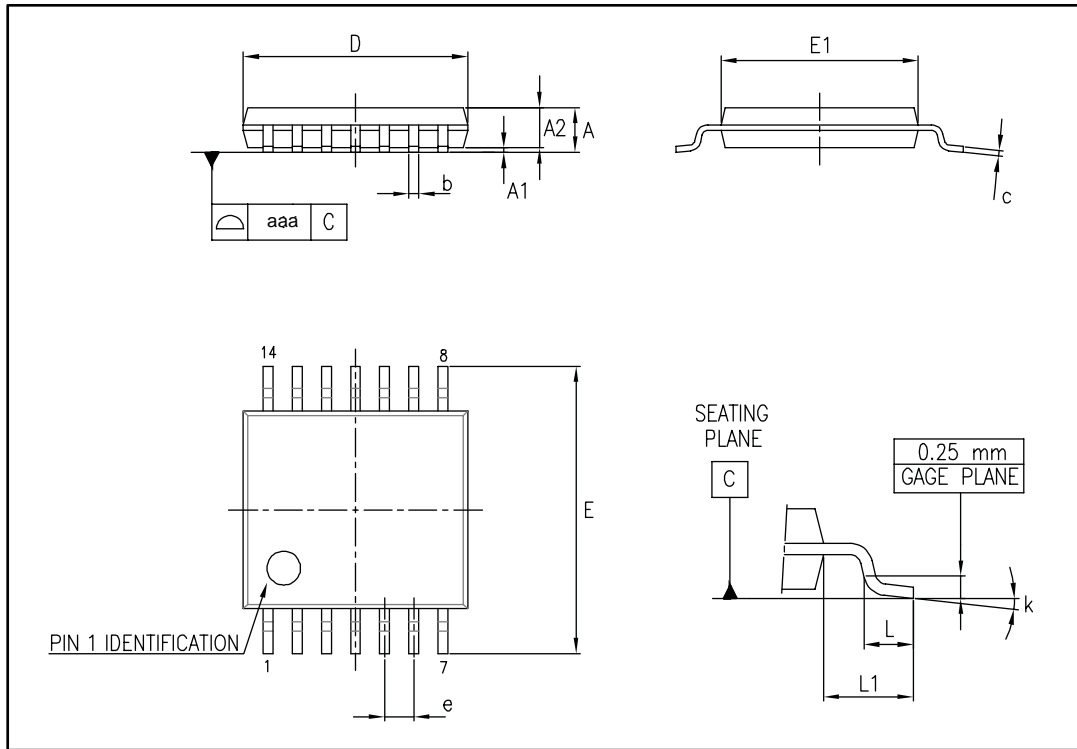

Table 7: TSSOP14 mechanical data

Ref.	Dimensions					
	Millimeters			Inches		
	Min.	Typ.	Max.	Min.	Typ.	Max.
A			1.20			0.047
A1	0.05		0.15	0.002	0.004	0.006
A2	0.80	1.00	1.05	0.031	0.039	0.041
b	0.19		0.30	0.007		0.012
c	0.09		0.20	0.004		0.0089
D	4.90	5.00	5.10	0.193	0.197	0.201
E	6.20	6.40	6.60	0.244	0.252	0.260
E1	4.30	4.40	4.50	0.169	0.173	0.176
e		0.65			0.0256	
L	0.45	0.60	0.75	0.018	0.024	0.030
L1		1.00			0.039	
k	0°		8°	0°		8°
aaa			0.10			0.004

7.3 QFN16 3x3 package information

Figure 21: QFN16 3x3 package outline



The exposed pad is not internally connected and can be set to ground or left floating.

Table 8: QFN16 3x3 mechanical data

Ref.	Dimensiones					
	Millimeters			Inches		
	Min.	Typ.	Max.	Min.	Typ.	Max.
A	0.80	0.90	1.00	0.031	0.035	0.039
A1	0		0.05	0		0.002
A3		0.20			0.008	
b	0.18		0.30	0.007		0.012
D	2.90	3.00	3.10	0.114	0.118	0.122
D2	1.50		1.80	0.059		0.071
E	2.90	3.00	3.10	0.114	0.118	0.122
E2	1.50		1.80	0.059		0.071
e		0.50			0.020	
L	0.30		0.50	0.012		0.020

Figure 22: QFN16 3x3 recommended footprint

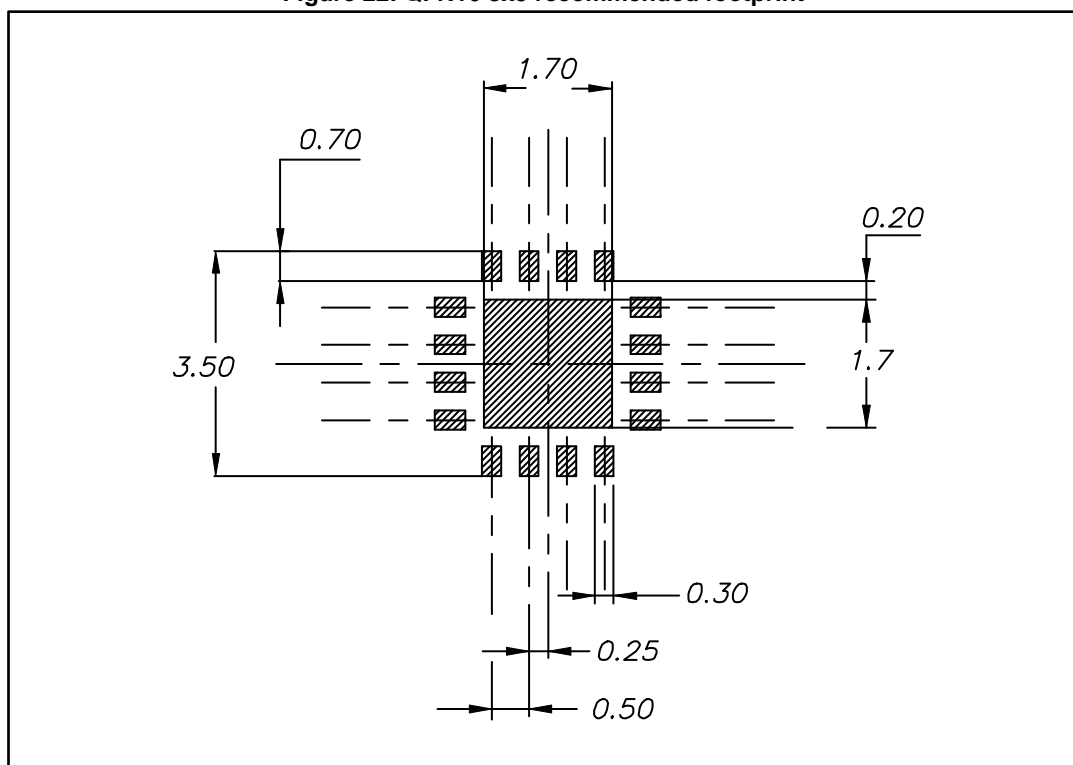

8 Ordering information

Table 9: Order codes

Order code	Temperature range	Package	Packing	Marking
TSX3704IDT	-40 °C to 125 °C	SO14	Tape and reel	TSX3704ID
TSX3704IPT		TSSOP14		TSX3704I
TSX3704IQ4T		QFN16 3x3		K533
TSX3704IYPT ⁽¹⁾		TSSOP14 (automotive grade)		TSX3704IY

Notes:

⁽¹⁾Qualification and characterization according to AEC Q100 and Q003 or equivalent, advanced screening according to AEC Q001 & Q 002 or equivalent are on-going.

9 Revision history

Table 10: Document revision history

Date	Revision	Changes
16-Dec-2015	1	Initial release
29-Feb-2016	2	Table 3 , Table 4 , and Table 5 : updated V_{OH} and V_{OL} condition $I_{OH}/I_{OL} = 4$ mA (not 6mA).

IMPORTANT NOTICE – PLEASE READ CAREFULLY

STMicroelectronics NV and its subsidiaries ("ST") reserve the right to make changes, corrections, enhancements, modifications, and improvements to ST products and/or to this document at any time without notice. Purchasers should obtain the latest relevant information on ST products before placing orders. ST products are sold pursuant to ST's terms and conditions of sale in place at the time of order acknowledgement.

Purchasers are solely responsible for the choice, selection, and use of ST products and ST assumes no liability for application assistance or the design of Purchasers' products.

No license, express or implied, to any intellectual property right is granted by ST herein.

Resale of ST products with provisions different from the information set forth herein shall void any warranty granted by ST for such product.

ST and the ST logo are trademarks of ST. All other product or service names are the property of their respective owners.

Information in this document supersedes and replaces information previously supplied in any prior versions of this document.

© 2016 STMicroelectronics – All rights reserved