

IttyBitty Comparator

Features

- 2V to 36V Supply
- 300 μ A Supply Current Independent of Supply
- 25 nA Input Bias Current
- ± 5 nA Input Offset Current
- ± 3 mV Input Offset Voltage
- Input Common Mode Voltage Range Includes Ground
- Differential Input Voltage Range Equal to the Power Supply Voltage
- 250 mV and 4 mA Output Saturation Voltage
- Output Compatible with TTL, DTL, ECL, MOS, and CMOS Logic

Applications

- Limit Comparators
- A/D Converters
- Pulse, Square-Wave, Time-Delay Generators
- Wide-Range VCO
- MOS Clock Timers
- Multi-Vibrators and High-Voltage Digital Logic Gates

General Description

The MIC6270 is a precision voltage comparator with an offset voltage specification of 5 mV maximum.

The MIC6270 is designed to operate from a single 2V to 36V power supply. Operation from split power supplies is also possible. Its low supply current drain is independent of the magnitude of the supply voltage.

This comparator also features an input common-mode voltage range that includes ground. Inputs are protected against reverse polarity (input voltage less than V-) and ESD.

The MIC6270 has an open-collector output that directly interfaces with TTL, CMOS, and other types of logic. Several MIC6270 outputs can be connected together for wired-OR logic. The output also features an internal pull-up current source that can be used instead of an external load in some applications.

Package Type

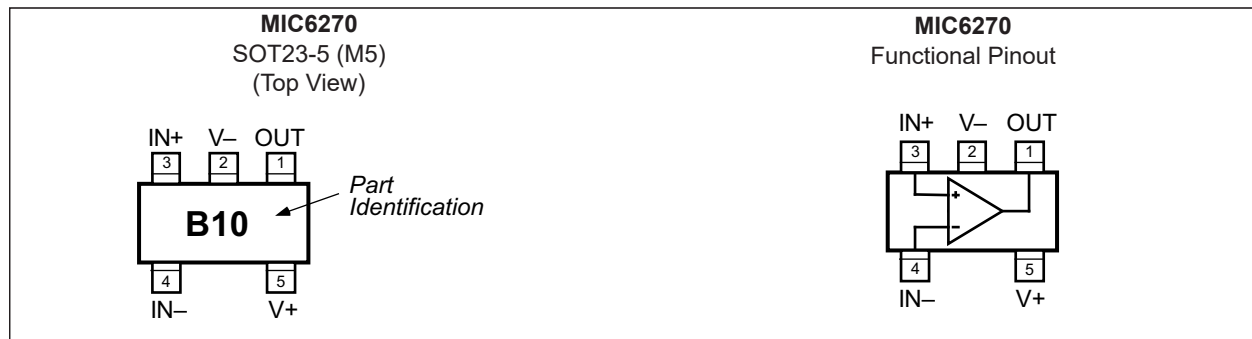

MIC6270

1.0 ELECTRICAL CHARACTERISTICS

Absolute Maximum Ratings †

Supply Voltage ($V_{V+} - V_{V-}$)	+36V or $\pm 18V$
Differential Input Voltage ($V_{IN+} - V_{IN-}$)	+36V
Input Voltage	-0.3V to +36V
Input Current ($V_{IN} < -0.3V$)	50 mA
Output Short-Circuit to GND, Note 1	∞

Operating Ratings ‡

Supply Voltage	+2V to +36V
----------------------	-------------

† **Notice:** Stresses above those listed under “Absolute Maximum Ratings” may cause permanent damage to the device. This is a stress rating only and functional operation of the device at those or any other conditions above those indicated in the operational sections of this specification is not intended. Exposure to maximum rating conditions for extended periods may affect device reliability.

‡ **Notice:** The device is not guaranteed to function outside the operating ratings.

Note 1: A short-circuit from OUT to V+ can cause excessive heating and damage the device. The maximum short-circuit output current (OUT to V-) is approximately 20 mA, independent of V_{V+} .

ELECTRICAL CHARACTERISTICS

Electrical Characteristics: $V_+ = 5V$; $T_A = +25^\circ C$, unless noted.

Parameters	Symbol	Min.	Typ.	Max.	Units	Conditions
Input Offset Voltage	V_{OS}	—	2	5	mV	Note 1
		—	—	9		Note 1, $-40^\circ C \leq T_A \leq +85^\circ C$
Input Bias Current	I_B	—	25	250	nA	$I_{IN(+)}$ or $I_{IN(-)}$ with output in linear range, $V_{CM} = 0V$, Note 2
		—	—	400		$I_{IN(+)}$ or $I_{IN(-)}$ with output in linear range, $V_{CM} = 0V$, Note 2, $-40^\circ C \leq T_A \leq +85^\circ C$
Input Offset Current	I_{OS}	—	5	50	nA	$I_{IN(+)} - I_{IN(-)}$, $V_{CM} = 0V$
		—	—	150		$I_{IN(+)} - I_{IN(-)}$, $V_{CM} = 0V$, $-40^\circ C \leq T_A \leq +85^\circ C$
Input Voltage Range	V_{CM}	0	—	$V_+ - 1.5$	V	$V_+ = 30V$, Note 3
		—	—	$V_+ - 2$		$V_+ = 30V$, Note 3, $-40^\circ C \leq T_A \leq +85^\circ C$
Supply Current	I_S	—	0.3	0.9	mA	$R_L = \infty$
		—	0.4	1.2		$R_L = \infty$, $V_+ = 36V$
Voltage Gain	—	50	200	—	V/mV	$R_L \geq 15\text{ k}\Omega$, $V_+ = 15V$ $V_O = 1V$ to $11V$
Large Signal Response Time	—	—	300	—	ns	$V_{IN} = \text{TTL logic swing}$, $V_{REF} = 1.4V$ $V_{RL} = 5V$, $R_L = 5.1\text{ k}\Omega$
Response Time	—	—	0.6	—	μs	$V_{RL} = 5V$, $R_L = 5.1\text{ k}\Omega$, Note 4
Output Sink Current	—	10	20	—	mA	$V_{IN(-)} = 1V$, $V_{IN(+)} = 0V$, $V_O \leq 1.5V$
Output Pull-Up Current	—	—	15	50	μA	—
Saturation Voltage	—	—	250	400	mV	$V_{IN(-)} = 1V$, $V_{IN(+)} = 0$, $I_{SINK} \leq 4\text{ mA}$
	—	—	—	700		$V_{IN(-)} = 1V$, $V_{IN(+)} = 0$, $I_{SINK} \leq 4\text{ mA}$, $-40^\circ C \leq T_A \leq +85^\circ C$
Differential Input Voltage	—	—	—	36	V	$V_{IN(+)}$, $V_{IN(-)} \geq 0V$ (or V_- , if used), Note 5

- Note 1:** Measured at the output switch point where $V_{OUT} \approx 1.4V_{DC}$ with $R_S = 0\Omega$, $V_+ = 5V_{DC}$ to $30V_{DC}$, and over the full input common-mode range ($0V_{DC}$ to $V_+ - 1.5V_{DC}$).
- 2:** The direction of input current is out of the device due to its PNP input.
- 3:** The input common-mode voltage, V_{IN+} , or V_{IN-} must not go below $-0.3V$. The upper end of the common-mode voltage range is $V_+ - 1.5V$ at $25^\circ C$, but either or both inputs can go to $+36V_{DC}$ without damage, independent of V_{V+} .
- 4:** The response time measured using a 100 mV input step with 5 mV overdrive. With greater overdrive, 300 ns can be obtained. See "Typical Performance Curves."
- 5:** Positive excursions of input voltage may exceed the power supply level. As long as the other voltage remains within the common-mode range, the comparator will provide a proper output state. The low input voltage state must not be below $-0.3V_{DC}$ (or $0.3V_{DC}$ below V_{V-}).

MIC6270

TEMPERATURE SPECIFICATIONS

Parameters	Sym.	Min.	Typ.	Max.	Units	Conditions
Temperature Ranges						
Ambient Temperature Range	T_A	-40	—	+125	°C	—
Storage Temperature Range	T_S	-65	—	+150	°C	—
Lead Temperature	—	—	—	+260	°C	Soldering, 10s
Package Thermal Resistance						
Thermal Resistance SOT-23-5	θ_{JA}	—	220	—	°C/W	Mounted to printed circuit board.

2.0 TYPICAL PERFORMANCE CURVES

Note: The graphs and tables provided following this note are a statistical summary based on a limited number of samples and are provided for informational purposes only. The performance characteristics listed herein are not tested or guaranteed. In some graphs or tables, the data presented may be outside the specified operating range (e.g., outside specified power supply range) and therefore outside the warranted range.

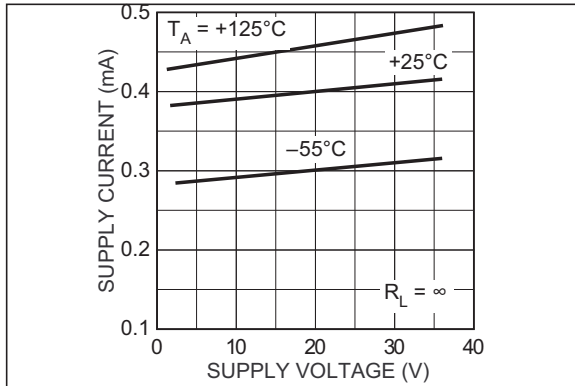

FIGURE 2-1: Supply Current vs. Supply Voltage.

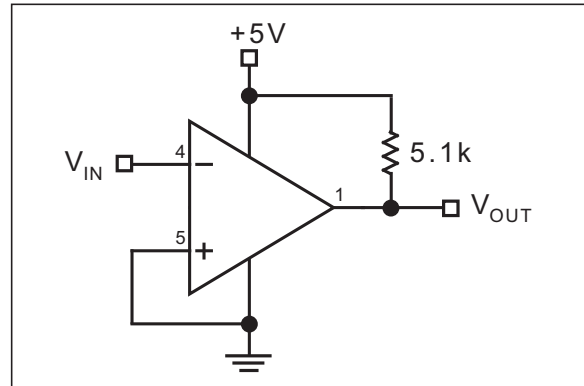

FIGURE 2-4: Output Response Time vs. Overdrive (Test Circuit).

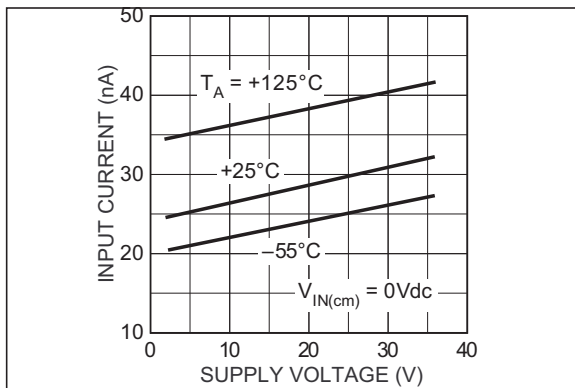

FIGURE 2-2: Input Current vs. Supply Voltage.

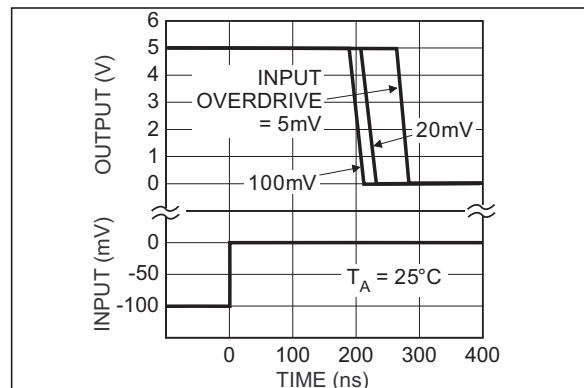

FIGURE 2-5: Output Response Time vs. Overdrive.

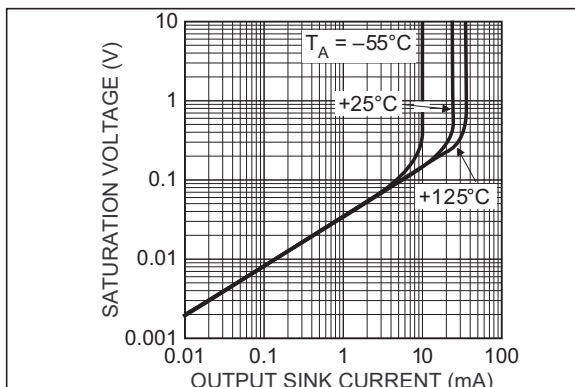

FIGURE 2-3: Output Saturation Voltage.

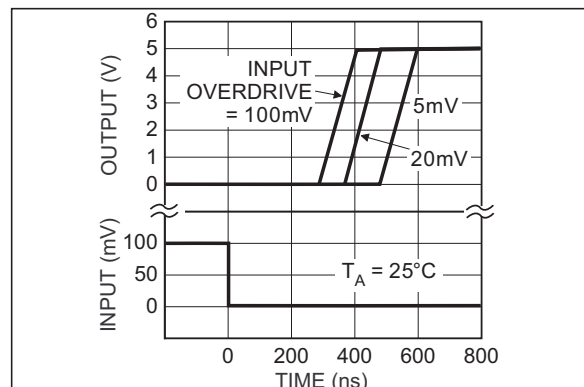

FIGURE 2-6: Output Response Time vs. Overdrive.

MIC6270

3.0 PIN DESCRIPTIONS

The descriptions of the pins are listed in [Table 3-1](#).

TABLE 3-1: PIN FUNCTION TABLE

Pin Number	Symbol	Description
1	OUT	Comparator output.
2	V-	Negative Supply: Negative supply for split supply application or ground for single supply application.
3	IN+	Non-inverting input.
4	IN-	Inverting input.
5	V+	Positive supply.

4.0 PACKAGING INFORMATION

4.1 Package Marking Information

5-Lead SOT23* (Front)	Example
<div style="border: 1px solid black; padding: 5px; width: 100px; margin: 0 auto;">XXX</div>	<div style="border: 1px solid black; padding: 5px; width: 100px; margin: 0 auto;">B10</div>
5-Lead SOT23* (Back)	Example
<div style="border: 1px solid black; padding: 5px; width: 100px; margin: 0 auto;">NNN</div>	<div style="border: 1px solid black; padding: 5px; width: 100px; margin: 0 auto;">971</div>

Legend:	<p>XX...X Product code or customer-specific information</p> <p>Y Year code (last digit of calendar year)</p> <p>YY Year code (last 2 digits of calendar year)</p> <p>WW Week code (week of January 1 is week '01')</p> <p>NNN Alphanumeric traceability code</p> <p>(e3) Pb-free JEDEC® designator for Matte Tin (Sn)</p> <p>* This package is Pb-free. The Pb-free JEDEC designator (e3) can be found on the outer packaging for this package.</p> <p>●, ▲, ▼ Pin one index is identified by a dot, delta up, or delta down (triangle mark).</p>
Note:	<p>In the event the full Microchip part number cannot be marked on one line, it will be carried over to the next line, thus limiting the number of available characters for customer-specific information. Package may or may not include the corporate logo.</p> <p>Underbar (_) and/or Overbar (¯) symbol may not be to scale.</p>

MIC6270

5-Lead SOT23 Package Outline and Recommended Land Pattern

Note: For the most current package drawings, please see the Microchip Packaging Specification located at <http://www.microchip.com/packaging>

TITLE

5 LEAD SOT23 PACKAGE OUTLINE & RECOMMENDED LAND PATTERN

DRAWING #	SOT23-5LD-PL-1	UNIT	MM
-----------	----------------	------	----

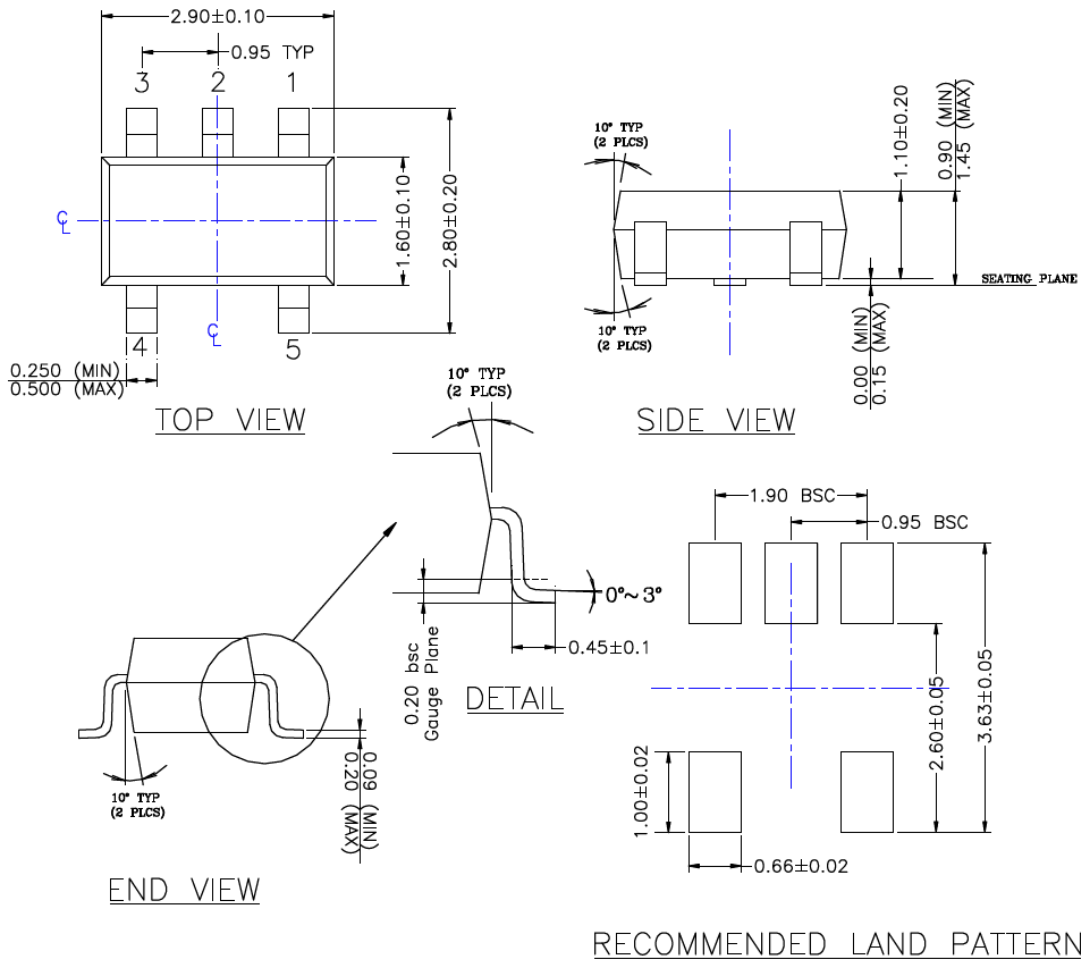

- NOTE:
1. PACKAGE OUTLINE EXCLUSIVE OF MOLD FLASH & BURR.
 2. PACKAGE OUTLINE INCLUSIVE OF SOLER PLATING.
 3. DIMENSION AND TOLERANCE PER ANSI Y14.5M, 1982.
 4. FOOT LENGTH MEASUREMENT BASED ON GAUGE PLANE METHOD.
 5. DIE FACES UP FOR MOLD, AND FACES DOWN FOR TRIM/FORM.
 6. ALL DIMENSIONS ARE IN MILLIMETERS.

APPENDIX A: REVISION HISTORY

Revision A (January 2020)

- Converted Micrel document MIC6270 to Microchip data sheet template DS20006294A.
- Minor text changes throughout.

MIC6270

NOTES:

PRODUCT IDENTIFICATION SYSTEM

To order or obtain information, e.g., on pricing or delivery, contact your local Microchip representative or sales office.

<u>PART NO.</u>		X	XX	-XX
Device	Temperature	Package	Media Type	
Device:	MIC6270:	IttyBitty® Comparator		
Temperature:	Y =	-40°C to +85°C		
Package:	M5 =	5-Lead SOT-23		
Media Type:	TR =	3,000/Reel		

Examples:

a) MIC6270YM5-TR: IttyBitty® Comparator, -40°C to +85°C Junction Temperature Range, 5-Pin SOT-23 Package, 3,000/Reel

Note 1: Tape and Reel identifier only appears in the catalog part number description. This identifier is used for ordering purposes and is not printed on the device package. Check with your Microchip Sales Office for package availability with the Tape and Reel option.

MIC6270

NOTES:

Note the following details of the code protection feature on Microchip devices:

- Microchip products meet the specification contained in their particular Microchip Data Sheet.
- Microchip believes that its family of products is one of the most secure families of its kind on the market today, when used in the intended manner and under normal conditions.
- There are dishonest and possibly illegal methods used to breach the code protection feature. All of these methods, to our knowledge, require using the Microchip products in a manner outside the operating specifications contained in Microchip's Data Sheets. Most likely, the person doing so is engaged in theft of intellectual property.
- Microchip is willing to work with the customer who is concerned about the integrity of their code.
- Neither Microchip nor any other semiconductor manufacturer can guarantee the security of their code. Code protection does not mean that we are guaranteeing the product as “unbreakable.”

Code protection is constantly evolving. We at Microchip are committed to continuously improving the code protection features of our products. Attempts to break Microchip's code protection feature may be a violation of the Digital Millennium Copyright Act. If such acts allow unauthorized access to your software or other copyrighted work, you may have a right to sue for relief under that Act.

Information contained in this publication regarding device applications and the like is provided only for your convenience and may be superseded by updates. It is your responsibility to ensure that your application meets with your specifications. MICROCHIP MAKES NO REPRESENTATIONS OR WARRANTIES OF ANY KIND WHETHER EXPRESS OR IMPLIED, WRITTEN OR ORAL, STATUTORY OR OTHERWISE, RELATED TO THE INFORMATION, INCLUDING BUT NOT LIMITED TO ITS CONDITION, QUALITY, PERFORMANCE, MERCHANTABILITY OR FITNESS FOR PURPOSE. Microchip disclaims all liability arising from this information and its use. Use of Microchip devices in life support and/or safety applications is entirely at the buyer's risk, and the buyer agrees to defend, indemnify and hold harmless Microchip from any and all damages, claims, suits, or expenses resulting from such use. No licenses are conveyed, implicitly or otherwise, under any Microchip intellectual property rights unless otherwise stated.

Trademarks

The Microchip name and logo, the Microchip logo, Adaptec, AnyRate, AVR, AVR logo, AVR Freaks, BesTime, BitCloud, chipKIT, chipKIT logo, CryptoMemory, CryptoRF, dsPIC, FlashFlex, flexPWR, HELDO, IGLOO, JukeBlox, KeeLoq, Klear, LANCheck, LinkMD, maXStylus, maXTouch, MediaLB, megaAVR, Microsemi, Microsemi logo, MOST, MOST logo, MPLAB, OptoLyzer, PackeTime, PIC, picoPower, PICSTART, PIC32 logo, PolarFire, Prochip Designer, QTouch, SAM-BA, SenGenuity, SpyNIC, SST, SST Logo, SuperFlash, Symmetricom, SyncServer, Tachyon, TempTrackr, TimeSource, tinyAVR, UNI/O, Vectron, and XMEGA are registered trademarks of Microchip Technology Incorporated in the U.S.A. and other countries.

APT, ClockWorks, The Embedded Control Solutions Company, EtherSynch, FlashTec, Hyper Speed Control, HyperLight Load, IntelliMOS, Libero, motorBench, mTouch, Powermite 3, Precision Edge, ProASIC, ProASIC Plus, ProASIC Plus logo, Quiet-Wire, SmartFusion, SyncWorld, Temux, TimeCesium, TimeHub, TimePictra, TimeProvider, Vite, WinPath, and ZL are registered trademarks of Microchip Technology Incorporated in the U.S.A.

Adjacent Key Suppression, AKS, Analog-for-the-Digital Age, Any Capacitor, AnyIn, AnyOut, BlueSky, BodyCom, CodeGuard, CryptoAuthentication, CryptoAutomotive, CryptoCompanion, CryptoController, dsPICDEM, dsPICDEM.net, Dynamic Average Matching, DAM, ECAN, EtherGREEN, In-Circuit Serial Programming, ICSP, INICnet, Inter-Chip Connectivity, JitterBlocker, KlearNet, KlearNet logo, memBrain, Mindi, MiWi, MPASM, MPF, MPLAB Certified logo, MPLIB, MPLINK, MultiTRAK, NetDetach, Omniscient Code Generation, PICDEM, PICDEM.net, PICKit, PICtail, PowerSmart, PureSilicon, QMatrix, REAL ICE, Ripple Blocker, SAM-ICE, Serial Quad I/O, SMART-I.S., SQI, SuperSwitcher, SuperSwitcher II, Total Endurance, TSHARC, USBCheck, VariSense, ViewSpan, WiperLock, Wireless DNA, and ZENA are trademarks of Microchip Technology Incorporated in the U.S.A. and other countries.

SQTP is a service mark of Microchip Technology Incorporated in the U.S.A.

The Adaptec logo, Frequency on Demand, Silicon Storage Technology, and Symmcom are registered trademarks of Microchip Technology Inc. in other countries.

GestIC is a registered trademark of Microchip Technology Germany II GmbH & Co. KG, a subsidiary of Microchip Technology Inc., in other countries.

All other trademarks mentioned herein are property of their respective companies.

© 2020, Microchip Technology Incorporated, All Rights Reserved.

ISBN: 978-1-5224-5492-2

For information regarding Microchip's Quality Management Systems, please visit www.microchip.com/quality.



MICROCHIP

Worldwide Sales and Service

AMERICAS

Corporate Office
2355 West Chandler Blvd.
Chandler, AZ 85224-6199
Tel: 480-792-7200
Fax: 480-792-7277
Technical Support:
<http://www.microchip.com/support>
Web Address:
www.microchip.com

Atlanta

Duluth, GA
Tel: 678-957-9614
Fax: 678-957-1455

Austin, TX

Tel: 512-257-3370

Boston

Westborough, MA
Tel: 774-760-0087
Fax: 774-760-0088

Chicago

Itasca, IL
Tel: 630-285-0071
Fax: 630-285-0075

Dallas

Addison, TX
Tel: 972-818-7423
Fax: 972-818-2924

Detroit

Novi, MI
Tel: 248-848-4000

Houston, TX

Tel: 281-894-5983

Indianapolis

Noblesville, IN
Tel: 317-773-8323
Fax: 317-773-5453
Tel: 317-536-2380

Los Angeles

Mission Viejo, CA
Tel: 949-462-9523
Fax: 949-462-9608
Tel: 951-273-7800

Raleigh, NC

Tel: 919-844-7510

New York, NY

Tel: 631-435-6000

San Jose, CA

Tel: 408-735-9110
Tel: 408-436-4270

Canada - Toronto

Tel: 905-695-1980
Fax: 905-695-2078

ASIA/PACIFIC

Australia - Sydney
Tel: 61-2-9868-6733

China - Beijing
Tel: 86-10-8569-7000

China - Chengdu
Tel: 86-28-8665-5511

China - Chongqing
Tel: 86-23-8980-9588

China - Dongguan
Tel: 86-769-8702-9880

China - Guangzhou
Tel: 86-20-8755-8029

China - Hangzhou
Tel: 86-571-8792-8115

China - Hong Kong SAR
Tel: 852-2943-5100

China - Nanjing
Tel: 86-25-8473-2460

China - Qingdao
Tel: 86-532-8502-7355

China - Shanghai
Tel: 86-21-3326-8000

China - Shenyang
Tel: 86-24-2334-2829

China - Shenzhen
Tel: 86-755-8864-2200

China - Suzhou
Tel: 86-186-6233-1526

China - Wuhan
Tel: 86-27-5980-5300

China - Xian
Tel: 86-29-8833-7252

China - Xiamen
Tel: 86-592-2388138

China - Zhuhai
Tel: 86-756-3210040

ASIA/PACIFIC

India - Bangalore
Tel: 91-80-3090-4444

India - New Delhi
Tel: 91-11-4160-8631

India - Pune
Tel: 91-20-4121-0141

Japan - Osaka
Tel: 81-6-6152-7160

Japan - Tokyo
Tel: 81-3-6880-3770

Korea - Daegu
Tel: 82-53-744-4301

Korea - Seoul
Tel: 82-2-554-7200

Malaysia - Kuala Lumpur
Tel: 60-3-7651-7906

Malaysia - Penang
Tel: 60-4-227-8870

Philippines - Manila
Tel: 63-2-634-9065

Singapore
Tel: 65-6334-8870

Taiwan - Hsin Chu
Tel: 886-3-577-8366

Taiwan - Kaohsiung
Tel: 886-7-213-7830

Taiwan - Taipei
Tel: 886-2-2508-8600

Thailand - Bangkok
Tel: 66-2-694-1351

Vietnam - Ho Chi Minh
Tel: 84-28-5448-2100

EUROPE

Austria - Wels
Tel: 43-7242-2244-39
Fax: 43-7242-2244-393

Denmark - Copenhagen
Tel: 45-4450-2828
Fax: 45-4485-2829

Finland - Espoo
Tel: 358-9-4520-820

France - Paris
Tel: 33-1-69-53-63-20
Fax: 33-1-69-30-90-79

Germany - Garching
Tel: 49-8931-9700

Germany - Haan
Tel: 49-2129-3766400

Germany - Heilbronn
Tel: 49-7131-72400

Germany - Karlsruhe
Tel: 49-721-625370

Germany - Munich
Tel: 49-89-627-144-0
Fax: 49-89-627-144-44

Germany - Rosenheim
Tel: 49-8031-354-560

Israel - Ra'anana
Tel: 972-9-744-7705

Italy - Milan
Tel: 39-0331-742611
Fax: 39-0331-466781

Italy - Padova
Tel: 39-049-7625286

Netherlands - Drunen
Tel: 31-416-690399
Fax: 31-416-690340

Norway - Trondheim
Tel: 47-7288-4388

Poland - Warsaw
Tel: 48-22-3325737

Romania - Bucharest
Tel: 40-21-407-87-50

Spain - Madrid
Tel: 34-91-708-08-90
Fax: 34-91-708-08-91

Sweden - Gothenberg
Tel: 46-31-704-60-40

Sweden - Stockholm
Tel: 46-8-5090-4654

UK - Wokingham
Tel: 44-118-921-5800
Fax: 44-118-921-5820