



CY54/74FCT841T

10-Bit Latch

Features

- Function, pinout and drive compatible with FCT, F, and AM29841 logic
- FCT-C speed at 5.5ns max. (Com'l)
FCT-B speed at 6.5ns max. (Com'l)
- Reduced V_{OH} (typically = 3.3V) versions of equivalent FCT functions
- Edge-rate control circuitry for significantly improved noise characteristics
- Power-off disable feature
- Matched rise and fall times
- ESD > 2000V
- Fully compatible with TTL input and output logic levels
- Sink current 64 mA (Com'l),
 32 mA (Mil)
- Source current 32 mA (Com'l),
 12 mA (Mil)

- High-speed parallel latches
- Buffered common latch enable input

Functional Description

The FCT841T bus interface latch is designed to eliminate the extra packages required to buffer existing latches and provide extra data width for wider address/data paths or buses carrying parity. The FCT841T is a buffered 10-bit wide version of the FCT373 function.

The FCT841T high-performance interface is designed for high-capacitance load drive capability while providing low-capacitance bus loading at both inputs and outputs. Outputs are designed for low-capacitance bus loading in the high impedance state and are designed with a power-off disable feature to allow for live insertion of boards.

Functional Block Diagram

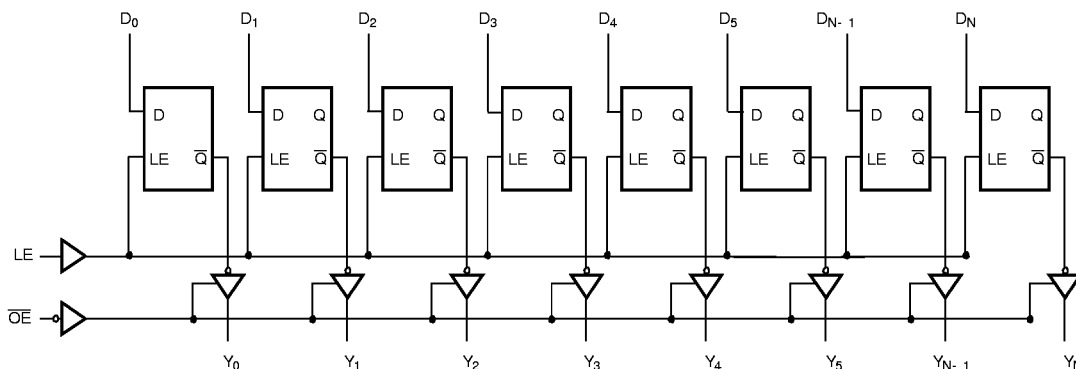

Logic Block Diagram

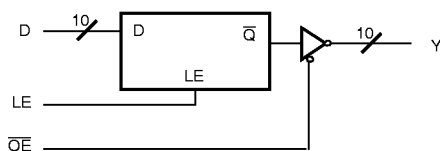

Pin Configurations

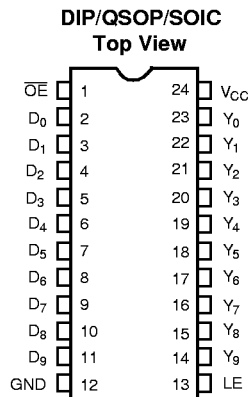



Pin Description

Name	I/O	Description
D	I	The latch data inputs.
LE	I	The latch enable input. The latches are transparent when LE is HIGH. Input data is latched on the HIGH-to-LOW transition.
Y	O	The three-state latch outputs.
\overline{OE}	I	The output enable control. When the \overline{OE} is LOW, the outputs are enabled. When \overline{OE} is HIGH, the outputs Y ₁ are in the high impedance (off) state.

Function Table^[1]

Inputs			Internal Outputs		Function
\overline{OE}	LE	D	O	Y	
H	X	X	X	Z	High Z
H	H	L	L	Z	
H	H	H	H	Z	
H	L	X	NC	Z	Latched (High Z)
L	H	L	L	L	Transparent
L	H	H	H	H	
L	L	X	NC	NC	Latched

Maximum Ratings^[2, 3]

(Above which the useful life may be impaired. For user guidelines, not tested.)

- Storage Temperature -65°C to +150°C
- Ambient Temperature with Power Applied -65°C to +135°C
- Supply Voltage to Ground Potential -0.5V to +7.0V
- DC Input Voltage -0.5V to +7.0V
- DC Output Voltage -0.5V to +7.0V

- DC Output Current (Maximum Sink Current/Pin) 120 mA
- Power Dissipation 0.5W
- Static Discharge Voltage >2001V (per MIL-STD-883, Method 3015)

Operating Range

Range	Range	Ambient Temperature	V _{CC}
Commercial	All	-40°C to +85°C	5V ± 5%
Military ^[4]	All	-55°C to +125°C	5V ± 10%

Notes:

1. H = HIGH Voltage Level, L = LOW Voltage Level, X = Don't Care, NC = No Change, Z = High Impedance.
2. Unless otherwise noted, these limits are over the operating free-air temperature range.
3. Unused inputs must always be connected to an appropriate logic voltage level, preferably either V_{CC} or ground.
4. T_A is the "instant on" case temperature.

Electrical Characteristics Over the Operating Range

Parameter	Description	Test Conditions	Min.	Typ. ^[5]	Max.	Unit	
V _{OH}	Output HIGH Voltage	V _{CC} = Min., I _{OH} = -32 mA	Com'l	2.0		V	
		V _{CC} = Min., I _{OH} = -15 mA	Com'l	2.4	3.3	V	
		V _{CC} = Min., I _{OH} = -12 mA	Mil	2.4	3.3	V	
V _{OL}	Output LOW Voltage	V _{CC} = Min., I _{OL} = 64 mA	Com'l		0.3	0.55	V
		V _{CC} = Min., I _{OL} = 32 mA	Mil		0.3	0.55	V
V _{IH}	Input HIGH Voltage		2.0			V	
V _{IL}	Input LOW Voltage				0.8	V	
V _H	Hysteresis ^[6]	All inputs		0.2		V	
V _{IK}	Input Clamp Diode Voltage	V _{CC} = Min., I _{IN} = -18 mA		-0.7	-1.2	V	
I _I	Input HIGH Current	V _{CC} = Max., V _{IN} = V _{CC}			5	μA	
I _{IH}	Input HIGH Current	V _{CC} = Max., V _{IN} = 2.7V			±1	μA	
I _{IL}	Input LOW Current	V _{CC} = Max., V _{IN} = 0.5V			±1	μA	
I _{OZH}	Off State HIGH-Level Output Current	V _{CC} = Max., V _{OUT} = 2.7V			10	μA	
I _{OZL}	Off State LOW-Level Output Current	V _{CC} = Max., V _{OUT} = 0.5V			-10	μA	
I _{OS}	Output Short Circuit Current ^[7]	V _{CC} = Max., V _{OUT} = 0.0V	-60	-120	-225	mA	
I _{OFF}	Power-Off Disable	V _{CC} = 0V, V _{OUT} = 4.5V			±1	μA	

Capacitance^[6]

Parameter	Description	Typ. ^[5]	Max.	Unit
C _{IN}	Input Capacitance	5	10	pF
C _{OUT}	Output Capacitance	9	12	pF

Notes:

- Typical values are at V_{CC}=5.0V, T_A=+25°C ambient.
- This parameter is guaranteed but not tested.
- Not more than one output should be shorted at a time. Duration of short should not exceed one second. The use of high-speed test apparatus and/or sample and hold techniques are preferable in order to minimize internal chip heating and more accurately reflect operational values. Otherwise prolonged shorting of a high output may raise the chip temperature well above normal and thereby cause invalid readings in other parametric tests. In any sequence of parameter tests, I_{OS} tests should be performed last.

Power Supply Characteristics

Parameter	Description	Test Conditions	Typ. ^[5]	Max.	Unit
I_{CC}	Quiescent Power Supply Current	$V_{CC} = \text{Max.}, V_{IN} \leq 0.2V, V_{IN} \geq V_{CC}-0.2V$	0.1	0.2	mA
ΔI_{CC}	Quiescent Power Supply Current (TTL inputs HIGH)	$V_{CC} = \text{Max.}, V_{IN} = 3.4V, f_1 = 0, \text{Outputs Open}^{[8]}$	0.5	2.0	mA
I_{CCD}	Dynamic Power Supply Current ^[9]	$V_{CC} = \text{Max.}, 50\% \text{ Duty Cycle, Outputs Open, One Input Toggling, } \overline{OE} = \text{GND}, LE = V_{CC}, V_{IN} \leq 0.2V \text{ or } V_{IN} \geq V_{CC}-0.2V$	0.06	0.12	mA/MHz
I_C	Total Power Supply Current ^[10]	$V_{CC} = \text{Max.}, 50\% \text{ Duty Cycle, Outputs Open, One Bit Toggling at } f_1 = 10 \text{ MHz, } \overline{OE} = \text{GND}, LE = V_{CC}, V_{IN} \leq 0.2V \text{ or } V_{IN} \geq V_{CC}-0.2V$	0.7	1.4	mA
		$V_{CC} = \text{Max.}, 50\% \text{ Duty Cycle, Outputs Open, One Bit Toggling at } f_1 = 10 \text{ MHz, } \overline{OE} = \text{GND}, LE = V_{CC}, V_{IN} = 3.4V \text{ or } V_{IN} = \text{GND}$	1.0	2.4	mA
		$V_{CC} = \text{Max.}, 50\% \text{ Duty Cycle, Outputs Open, Ten Bits Toggling at } f_1 = 2.5 \text{ MHz, } \overline{OE} = \text{GND}, LE = V_{CC}, V_{IN} \leq 0.2V \text{ or } V_{IN} \geq V_{CC}-0.2V$	1.0	3.2 ^[11]	mA
		$V_{CC} = \text{Max.}, 50\% \text{ Duty Cycle, Outputs Open, Ten Bits Toggling at } f_1 = 2.5 \text{ MHz, } \overline{OE} = \text{GND}, LE = V_{CC}, V_{IN} = 3.4V \text{ or } V_{IN} = \text{GND}$	4.1	13.2 ^[11]	mA

Notes:

8. Per TTL driven input ($V_{IN}=3.4V$); all other inputs at V_{CC} or GND.
9. This parameter is not directly testable, but is derived for use in Total Power Supply calculations.
10. $I_C = I_{\text{QUIESCENT}} + I_{\text{INPUTS}} + I_{\text{DYNAMIC}}$
 $I_C = I_{CC} + \Delta I_{CC} D_H N_T + I_{CCD} (f_0/2 + f_1 N_1)$
 I_{CC} = Quiescent Current with CMOS input levels
 ΔI_{CC} = Power Supply Current for a TTL HIGH input ($V_{IN}=3.4V$)
 D_H = Duty Cycle for TTL inputs HIGH
 N_T = Number of TTL inputs at D_H
 I_{CCD} = Dynamic Current caused by an input transition pair HLH or LHL
 f_0 = Clock frequency for registered devices, otherwise zero
 f_1 = Input signal frequency
 N_1 = Number of inputs changing at f_1
 All currents are in milliamps and all frequencies are in megahertz.
11. Values for these conditions are examples of the I_{CC} formula. These limits are guaranteed but not tested.



Switching Characteristics Over the Operating Range^[12]

Parameter	Description	Test Load	FCT841AT				FCT841BT		FCT841CT		Unit	Fig. No. ^[13]
			Military		Commercial		Commercial		Commercial			
			Min.	Max.	Min.	Max.	Min.	Max.	Min.	Max.		
t _{PLH} t _{PHL}	Propagation Delay D ₁ to Y ₁ (L =HIGH)	C _L = 50 pF R _L = 500Ω	1.5	10.0	1.5	9.0	1.5	6.5	1.5	5.5	ns	1, 3
	Propagation Delay D ₁ to Y ₁ (LE=HIGH)	C _L = 300 pF R _L = 500Ω	1.5	15.0	1.5	13.0	1.5	13.0	1.5	13.0	ns	1, 3
t _{SU}	Data to LE Set-Up Time	C _L = 50 pF R _L = 500Ω	2.5		2.5		2.5		2.5		ns	9
t _H	Data to LE Hold Time	C _L = 50 pF R _L = 500Ω	3.0		2.5		2.5		2.5		ns	9
t _{PLH} t _{PHL}	Propagation Delay LE to Y ₁	C _L = 50 pF R _L = 500Ω	1.5	13.0	1.5	12.0	1.5	8.0	1.5	6.4	ns	1, 3
	Propagation Delay LE to Y ₁ ^[12]	C _L = 300 pF R _L = 500Ω	1.5	20.0	1.5	16.0	1.5	15.5	1.5	15.0	ns	1, 3
t _W	LE Pulse Width (HIGH)	C _L = 50 pF R _L = 500Ω	5.0		4.0		4.0		4.0		ns	5
t _{PZH} t _{PZL}	Output Enable Time OE to Y ₁	C _L = 50 pF R _L = 500Ω	1.5	13.0	1.5	11.5	1.5	8.0	1.5	6.5	ns	1, 7, 8
	Output Enable Time OE to Y ₁ ^[12]	C _L = 300 pF R _L = 500Ω	1.5	25.0	1.5	23.0	1.5	14.0	1.5	12.0	ns	1, 7, 8
t _{PHZ} t _{PLZ}	Output Disable Time OE to Y ₁ ^[12]	C _L = 5 pF R _L = 500Ω	1.5	9.0	1.5	7.0	1.5	6.0	1.5	5.7	ns	1, 7, 8
	Output Disable Time OE to Y ₁	C _L = 50 pF R _L = 500Ω	1.5	10.0	1.5	8.0	1.5	7.0	1.5	6.0	ns	1, 7, 8

Ordering Information

Speed (ns)	Ordering Code	Package Name	Package Type	Operating Range
5.5	CY74FCT841CTQC	Q13	24-Lead (150-Mil) QSOP	Commercial
	CY74FCT841CTSOC	S13	24-Lead (300-Mil) Molded SOIC	
6.5	CY74FCT841BTQC	Q13	24-Lead (150-Mil) QSOP	Commercial
	CY74FCT841BTSOC	S13	24-Lead (300-Mil) Molded SOIC	
9.0	CY74FCT841ATQC	Q13	24-Lead (150-Mil) QSOP	Commercial
	CY74FCT841ATSOC	S13	24-Lead (300-Mil) Molded SOIC	
10.0	CY54FCT841ATDMB	D14	24-Lead (300-Mil) CerDIP	Military

Notes:

- 12. Minimum limits are guaranteed but not tested on Propagation Delays.
- 13. See "Parameter Measurement Information" in the General Information section.

Package Diagrams

24-Lead (300-Mil) CerDIP D14 MIL-STD-1835 D-9Config.A

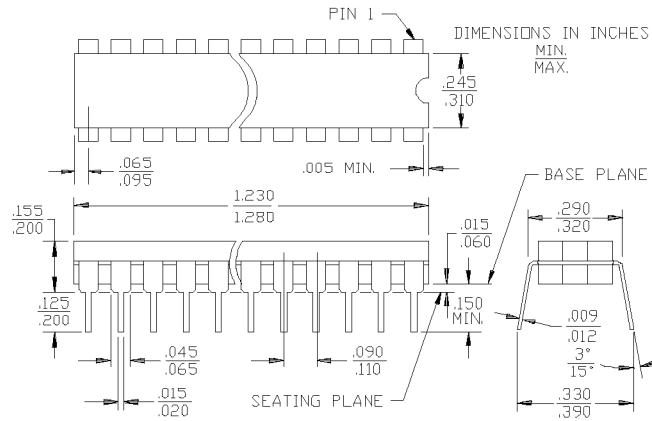

24-Lead (300-Mil) Molded DIP P13/P13A

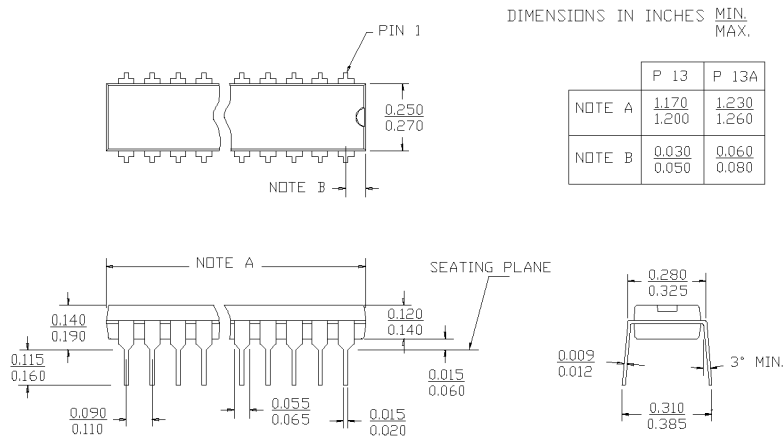

Package Diagrams (continued)

24-Lead Quarter Size Outline Q13

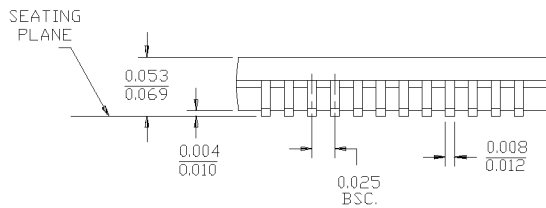
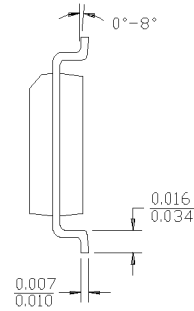
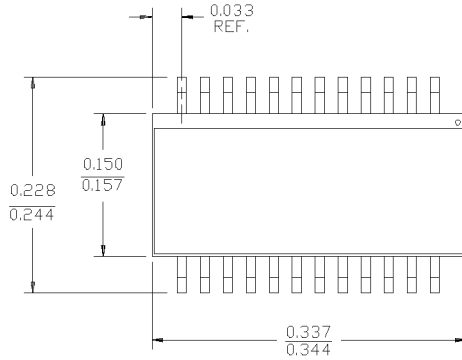

DIMENSIONS IN INCHES MIN. MAX.
LEAD COPLANARITY 0.004 MAX.

24-Lead (300-Mil) Molded SOIC S13

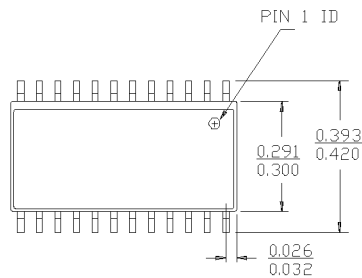

DIMENSIONS IN INCHES MIN. MAX.
LEAD COPLANARITY 0.004 MAX.

