

PLEASE CHECK WWW.MOLEX.COM FOR LATEST PART INFORMATION

Part Number: [0877823005](#)
Status: **Active**
Overview: MiniDIMM Sockets
Description: 0.60mm Pitch miniDIMM DDR3 Socket, Vertical, Surface Mount, 0.76µm Gold (Au) over Nickel, 1.5V, with Pick and Place Cover, 244 Circuits, Natural (Off White) Latch, Type A Tray, Lead-Free

Documents:

3D Model	Application Specification AS-87782-001-001 (PDF)
Drawing (PDF)	Packaging Specification PK-87782-004-001 (PDF)
Product Specification PS-87782-027-001 (PDF)	RoHS Certificate of Compliance (PDF)

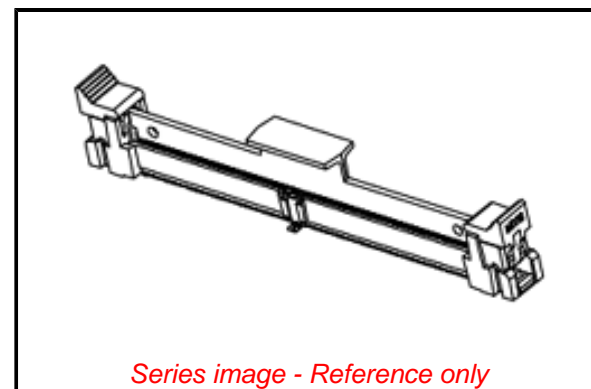

Agency Certification

CSA	LR19980
UL	E29179

General

Product Family	Memory Module Sockets
Series	87782
Comments	With Cap
Component Type	Socket
JEDEC Outline	MO-244
Overview	MiniDIMM Sockets
Product Name	MiniDIMM
Taxonomy	Memory Module Connectors
UPC	883906426224

Physical

Circuits (Loaded)	244
Circuits (maximum)	244
Durability (mating cycles max)	25
Entry Angle	Vertical (Top Entry)
Flammability	94V-0
Housing Color	Black
Keying to Mating Part	Yes
Latch Color	Natural (Off-White)
Material - Metal	Copper Alloy
Material - Plating Mating	Gold
Material - Plating Termination	Tin
Material - Resin	High Temperature Thermoplastic
Net Weight	5.350/g
PCB Locator	Yes
PCB Retention	Yes
Packaging Type	Tray
Pitch - Mating Interface	0.60mm
Pitch - Termination Interface	0.60mm
Plating min - Mating	0.762µm
Plating min - Termination	2.540µm
Temperature Range - Operating	-55° to +85°C
Termination Interface: Style	Surface Mount

Electrical

Current - Maximum per Contact	1.0A
Voltage - Maximum	30V (RMS)
Voltage Key	1.5V

Solder Process Data

Duration at Max. Process Temperature (seconds)	005
--	-----

EU ELV

Not Relevant

EU RoHS

Compliant

REACH SVHC

Not Contained Per -
D(2022)4187-DC (10
June 2022)

Halogen-Free

Status

Not Low-Halogen

For more information, please visit [Contact US](#)

China ROHS

ELV

RoHS Phthalates

China RoHS

Green Image

Not Relevant

Not Contained

Search Parts in this Series

[87782 Series](#)

Mates With

JEDEC MO-244 Modules

Lead-freeProcess Capability	SMC&WAVE
Max. Cycles at Max. Process Temperature	002
Process Temperature max. C	260

Material Info

Reference - Drawing Numbers

Application Specification	AS-87782-001-001
Electrical Model Document	EE-87782-001-001, EE-87782-002-001, EE-87782-003-001, EE-87782-007-001
Packaging Specification	PK-87782-004-001
Product Specification	PS-87782-027-001
S-Parameter Model	SP-87782-001-001, SP-87782-007-001
Sales Drawing	SD-87782-001-001

This document was generated on 10/18/2022

PLEASE CHECK WWW.MOLEX.COM FOR LATEST PART INFORMATION