



The Infinite Bandwidth Company™

MIC2580

Hot-Swap PCI Power Controller

Final Information

General Description

The MIC2580 is a hot-swap controller that provides for safe and orderly insertion and removal of PCI based adapter cards from a PCI hot-plug compliant system backplane or CompactPCI™ system.

The MIC2580 incorporates a circuit breaker function that protects all four supplies (+12V, +5V, +3.3V, and -12V) upon an overcurrent fault condition. Current foldback limiting prevents large transient currents caused by plugging adapter cards into live backplanes, such as in a CompactPCI system. A programmable slew-rate control limits high inrush currents to all loads that occur when power is applied to large capacitive loads.

Voltage supervisory functions for all four power supplies are provided by "power good" (/PWRGD) and "overcurrent fault" (/FAULT) diagnostic outputs. Power good and overcurrent fault include deglitch filters to prevent nuisance tripping. Power good is active when all four supplies are within tolerance. Fault (/FAULT) goes active upon overcurrent or overtemperature conditions. The on-off control input (/ON) is used to cycle power to the adapter card.

Features

- PCI hot-plug and CompactPCI™ hot-swap support
- +12V, +5V, +3.3V, and -12V power supply control
- Circuit breaker function to protect system
- Programmable slew rate control for all supplies
- Foldback current-limiting
- +5V and +3.3V programmable current-limit thresholds
- Undervoltage and overcurrent diagnostic outputs
- Deglitch filters on diagnostic fault outputs
- Integrated +12V and -12V MOSFET switches
- Integrated high-side drivers for 3.3V and 5V external switches
- Precharge supply for CompatPCI™ I/O termination

Applications

- PCI hot-plug systems
- CompactPCI™ hot-swap systems

Typical Application

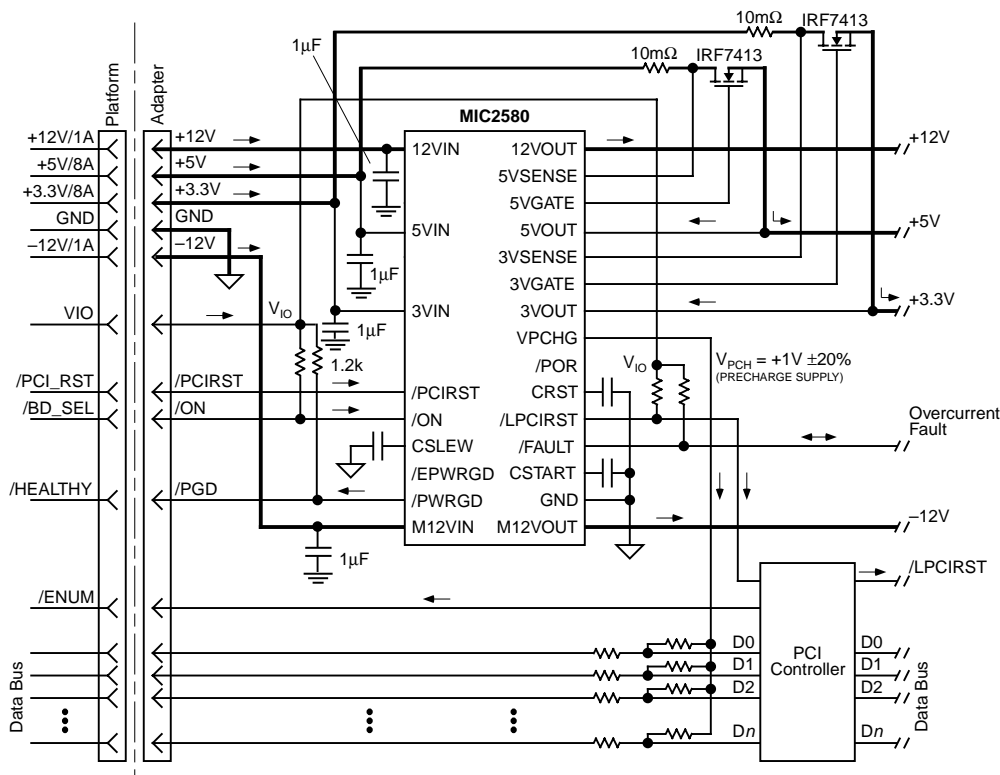

CompactPCI™ Adapter with Early Power

Compact PCI is a trademark of the PCI Industrial Computer Manufacturer's Group.

Micrel, Inc. • 1849 Fortune Drive • San Jose, CA 95131 • USA • tel + 1 (408) 944-0800 • fax + 1 (408) 944-0970 • http://www.micrel.com

Ordering Information

Part Number	Precharge Voltage	Temperature Range	Package
MIC2580-1.0BTS	1V	-40°C to +85°C	24-lead TSSOP
MIC2580-1.6BTS	1.6V	-40°C to +85°C	24-lead TSSOP

Pin Configuration

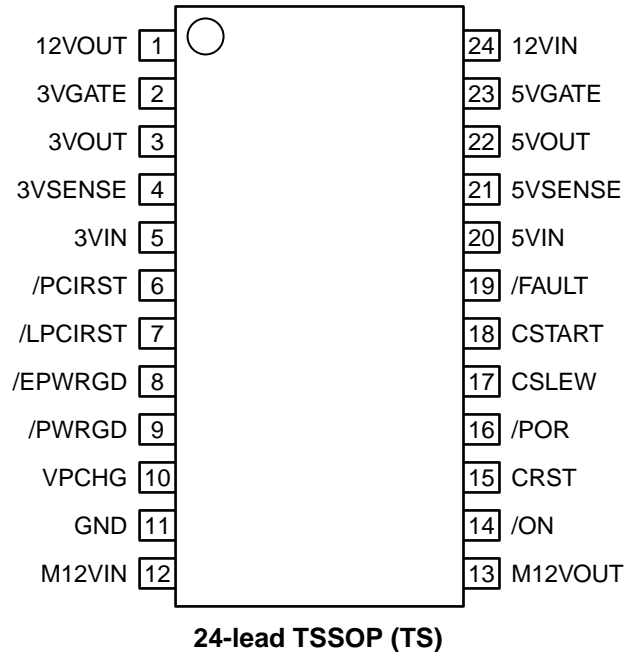

Pin Description

Pin Number	Pin Name	Pin Function
1	12VOUT	+12V Switched Supply (Output): Load carrying output.
2	3VGATE	3.3V Gate Drive (Output): Drives gate of external N-channel MOSFET +3V switch. Adding capacitance will slow the slew rate of the external MOSFET switch turn-on. (The external MOSFET's gate is charged by an internal current source.)
3	3VOUT	+3.3V Output Voltage Sense (Input): Connect to source of external N-channel MOSFET (+3V switched output) to monitor for output undervoltage conditions.
4	3VSENSE	+3.3V Current Sense (Input): Measures voltage drop across an external sense resistor with respect to 3VIN for overcurrent detection through the +3.3V switch.
5	3VIN	3V Supply (Input): +3.3V-supply input for current monitoring (reference input for 3VSENSE). Not a load-current carrying input.
6	/PCIRST	PCI-Bus Reset (Input): Input from PCI bus that resets the internal logic.

Pin Number	Pin Name	Pin Function
7	/LPCIRST	Local PCI Reset (Open-Drain Output): Local PCI reset output to PCI controller. Compliant to CompactPCI specification for LOCAL_PCI_RESET.
8	/EPWRGD	Early Power Good (Open-Drain Output): This signal goes active should /FAULT or /PWRGD go active. No deglitch filtering is provided. This signal satisfies PCI /RST timing for T_{FAIL} per PCI Local Bus Specification, version 2.1.
9	/PWRGD	Power Good (Open-Drain Output): Active-low output goes active when all supplies are within tolerance. (A 20 μ s delay is inserted prior to activation to reduce nuisance tripping.)
10	VPCHG	Precharge Supply (Output): (MIC2580-1.0) +1V \pm 20% supply used for precharge bias for I/O terminations (CompactPCI only).
11	GND	Ground
12	M12VIN	-12V Supply (Input): Input for internal -12V switch.
13	M12VOUT	-12V Switched Supply (Output): Switched -12V supply to PCI Hot Plug compliant socket. Load carrying output.
14	/ON	On-Off Control (Input): Logic low turns on all switches; logic high turns off all switches. Also used to reset the device from a circuit breaker condition.
15	CRST	Reset Delay (External Component): Connect to external capacitor (C_{RST}) to increase power-on reset delay.
16	/POR	Reset (Open-Drain Output): Active-low signal remains active for a time determined by C_{RST} after all supplies are within tolerance; i.e., /PWRGD is active. This signal may be used as a reset for logic controllers.
17	CSLEW	Slew (External Component): Connect to external capacitor (C_{SLEW}) to program the output slew rate of 3VGATE, 5VGATE, 12VGATE (internal) and M12VGATE (internal).
18	CSTART	Start-Up Timer (External Component): Connect to external capacitor (C_{START}) to increase the filter delay used to gate the /FAULT output upon start-up. Used to prevent nuisance tripping during turn-on of supplies.
19	/FAULT	Fault (Open-Drain Output/Input): This active-low output signal activated upon overcurrent or thermal shutdown. Includes 20 μ s deglitch filter. Fault is reset using /ON. Forcing pin low turns off all switches but does not activate the circuit breaker function.
20	5VIN	5V Supply (Input): +5V-supply input for current monitoring (reference voltage for 5VSENSE). Not a load-current carrying input.
21	5VSENSE	+5V Current Sense (Input): Measures voltage drop across an external sense resistor with respect to 5VIN for overcurrent detection through the +5V switch.
22	5VOUT	+5V Output Voltage Sense (Input): Connect to source of external N-channel MOSFET (+5V switched output) to monitor for output undervoltage conditions.
23	5VGATE	5V Gate Drive (Output): Drives gate of external N-channel MOSFET +5V switch. Adding capacitance will slow the slew rate of the external MOSFET switch turn-on. (The external MOSFET's gate is charged by an internal current source.)
24	12VIN	12V Supply (Input): MIC2580 power supply and input for internal +12 switch. Supplies power for internal circuitry.

Absolute Maximum Ratings (Note 1)

Supply Voltages

+12V Input (V_{12VIN})	+14V
+5V Input (V_{5VIN})	+7V
+3.3V Input (V_{3VIN})	+7V
-12V Input (V_{M12VIN})	-14V

/PWRGD, /FAULT, /POR, /EPWRGD, and /PCIRST

Output Current 10mA

Lead Temperature (soldering, 5sec.) 260°C

ESD Rating, **Note 3** TBD**Operating Ratings (Note 2)**

Supply Voltages

+12V Input (V_{12VIN})	+11.4V to +12.6V
-12V Input (V_{M12VIN})	-11.4V to +12.6V
+5V Input (V_{5VIN})	+4.25V to +5.25
+3.3V Input (V_{3VIN})	+3.1V to +3.5V

Temperature Range (T_A) -40°C to +85°CJunction Temperature (T_J) 160°CPackage Thermal Resistance (θ_{JA})

24-Lead TSSOP 83°C/W

Electrical Characteristics $V_{12VIN} = 12V$, $V_{5VIN} = 5V$, $V_{3VIN} = 3.3V$, $V_{M12VIN} = -12V$; $T_A = 25^\circ C$, **bold** values indicate $-40^\circ C \leq T_A \leq +85^\circ C$; unless noted

Symbol	Parameter	Condition	Min	Typ	Max	Units
I_{12IN}	Supply Current	/ON > V_{IH}		2.2	3	mA
I_{5IN}				4	6	mA
I_{3IN}				0.23	0.4	mA
I_{12MIN}				3	5	mA
V_{UVLO}	Undervoltage Lockout	V_{12VIN} increasing	8.9		9.8	V
		V_{12VIN} UVLO hysteresis		300		mV
		V_{M12VIN} decreasing	-10.5		-8.3	V
		V_{M12VIN} UVLO hysteresis		100		mV
		V_{5VIN} increasing	2.1		3.1	V
		V_{5VIN} UVLO hysteresis		20		mV
		V_{3VIN} increasing	2.4		2.6	V
V_{3VIN} UVLO hysteresis		60		mV		
V_{5VGATE}	5VGATE Voltage		10.5	11		V
V_{3VGATE}	3VGATE Voltage		10.5	11		V
I_{5VGATE}	5VGATE Output Current	during start-up, $V_{5VGATE} = 5V$		-40		μA
		during turnoff; /FAULT = 0		6		mA
I_{3VGATE}	3VGATE Output Current	during start-up, $V_{5VGATE} = 5V$		-40		μA
		during turnoff; /FAULT = 0		6		mA
V_{PGTH}	Power Good Threshold Voltage	V_{12VOUT} increasing	11		11.4	V
		V_{12VOUT} Power-Good hysteresis		200		mV
		$V_{M12VOUT}$ decreasing	-11.2		-10.3	V
		$V_{M12VOUT}$ Power-Good hysteresis		300		mV
		V_{5VOUT} increasing	4.6		4.8	V
		V_{5VOUT} Power-Good hysteresis		100		mV
		V_{3VOUT} increasing	2.95		3.16	V
V_{3VOUT} Power-Good hysteresis		60		mV		
V_{IL}	Input Voltage Level (/ON)	logic low			0.8	V
V_{IH}		logic high	2.0			V
I_{IL}	Input Leakage Current (/ON)		-1		1	μA

Symbol	Parameter	Condition	Min	Typ	Max	Units
V_{OL}	Output-Low Voltage (/PWRGD, /FAULT, /POR, EPWRGD, /LPCIRST)	$I_{OL} = 2\text{mA}$			0.4	V
T_{OV}	Overtemperature Shutdown Threshold	T_J increasing		170		$^{\circ}\text{C}$
		T_J decreasing		160		$^{\circ}\text{C}$
I_{CRST}	CRST Charge Current	during turn-on	-9		-11.5	μA
I_{CSTART}	CSTART Charge Current	during turn-on	-9		-11.5	μA
I_{CSLEW}	CSLEW Charge Current	during turn-on	-30	-39	-45	μA
$R_{DS(on)12}$	Output MOSFET Resistance	+12V internal MOSFET, $I_{DS} = 500\text{mA}$		450	600	$\text{m}\Omega$
$R_{DS(on)M12}$		-12V internal MOSFET, $I_{DS} = 200\text{mA}$		430	600	$\text{m}\Omega$
	Output MOSFET Leakage	+12V internal MOSFET	-100		100	μA
		-12V internal MOSFET	0		300	μA
V_{CLTH}	Current Limit Threshold Voltage	$V_{5VIN} - V_{5VSENSE}$	40	50	60	mV
		$V_{3VIN} - V_{3VSENSE}$	45	50	65	mV
I_{LIM12}	Current-Limit Threshold	+12V internal MOSFET, ramped load	1.0	1.3	1.5	A
I_{LIM12M}		-12V internal MOSFET, ramped load	-0.4	-0.5	-0.7	A
	Short-Circuit Current	+12V internal MOSFET, $V_{OUT} = 0\text{V}$		140		mA
		-12V internal MOSFET, $V_{OUT} = 0\text{V}$		-170		mA
$V_{POR(thr)}$	Power-On Reset Threshold Voltage			2.4		V
V_{PCH}	Precharge Bias Supply	MIC2580-1.0, $I_{PCH} = 10\text{mA}$	0.8	1.0	1.2	V
		MIC2580-1.6, $I_{PCH} = 10\text{mA}$	1.28	1.6	1.92	V
V_{START}	Start-up Threshold Voltage			2.4		V

AC Parameters

t_{GOOD}	Early Power-Good Response Low	See Figure 4		200		ns
t_{GOOD}	Early Power-Good Response High	See Figure 4		100		ns
	Undervoltage to Power-Good Delay			20		μs
	Current-limit to Fault Delay			20		μs
	+5V Current-Limit-to-Off Delay Note 4	$V_{SENSE} = 10\text{m}\Omega$		7		μs
	+3.3V Current-Limit-to-Off Delay Note 4	$V_{SENSE} = 10\text{m}\Omega$		7		μs
	+12V Current-Limit-to-Off Delay Note 4	+12V		25		μs
	-12V Current-Limit-to-Off Delay Note 4	-12V		25		μs

Note 1. Exceeding the absolute maximum rating may damage the device.

Note 2. The device is not guaranteed to function outside its operating rating.

Note 3. Devices are ESD sensitive. Handling precautions recommended. Human body model, 1.5k in series with 100pF.

Note 4. Off refers to the condition in which the circuit breaker turns all outputs off.

Timing Diagrams

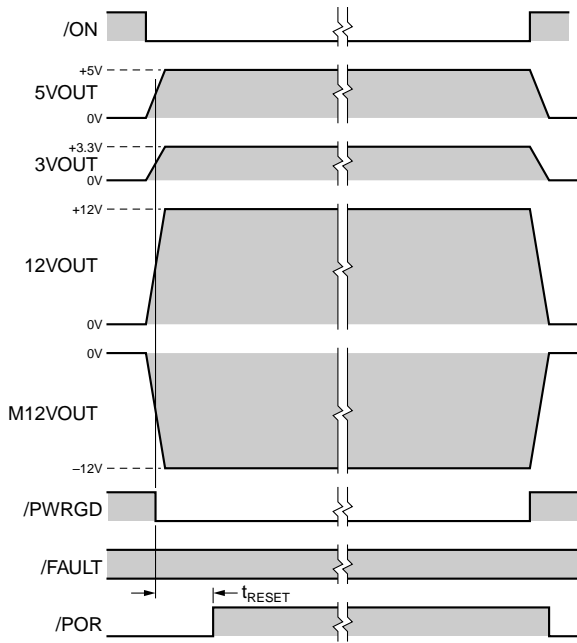

Figure 1. Controller Timing: Normal Cycle

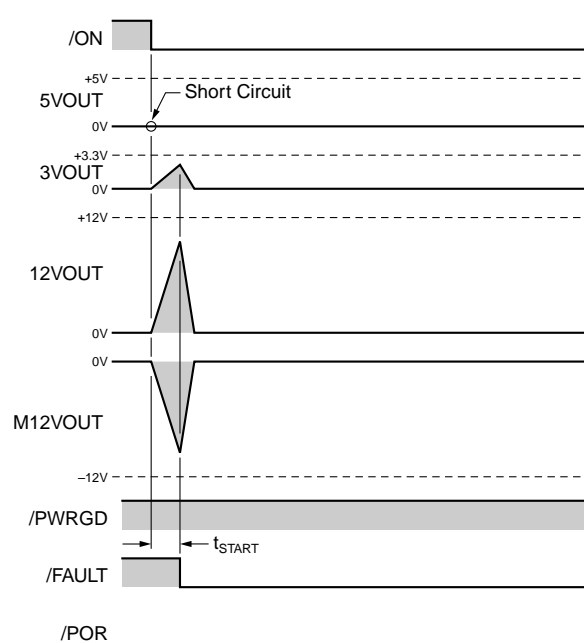

Figure 2. Controller Timing: Enable Into Short

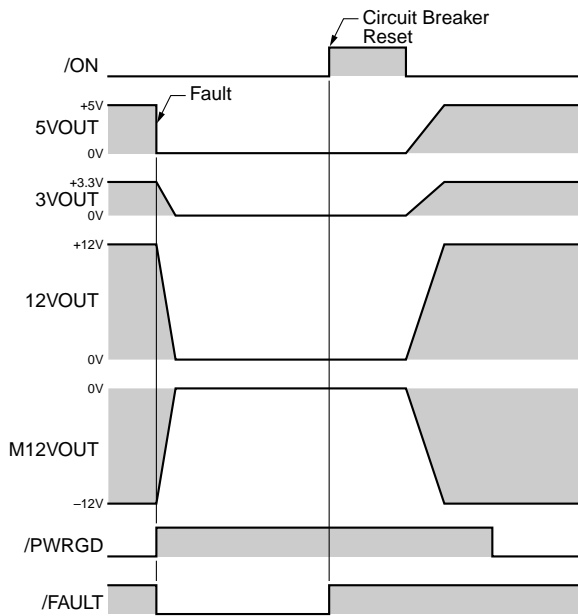

Figure 3. Controller Timing: Short on 5V

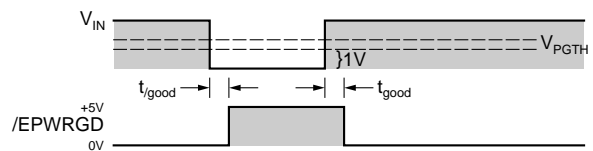
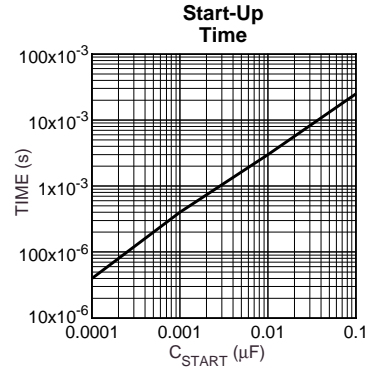
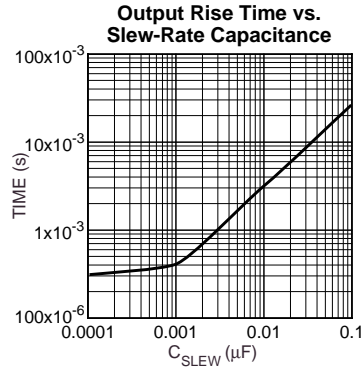
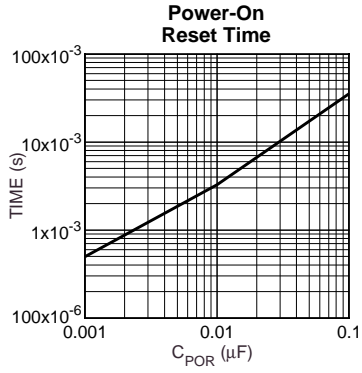
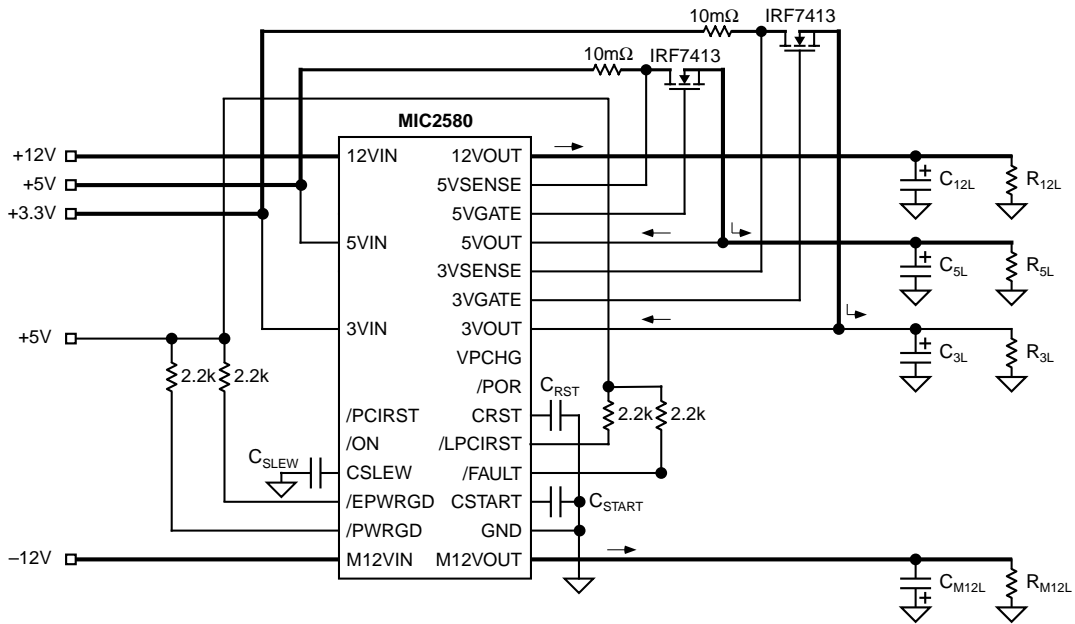

Figure 4. Early Power Good Response Time

Typical Characteristics



Functional Characteristics



Functional Test Circuit

3V and 5V Gate-Voltage Response

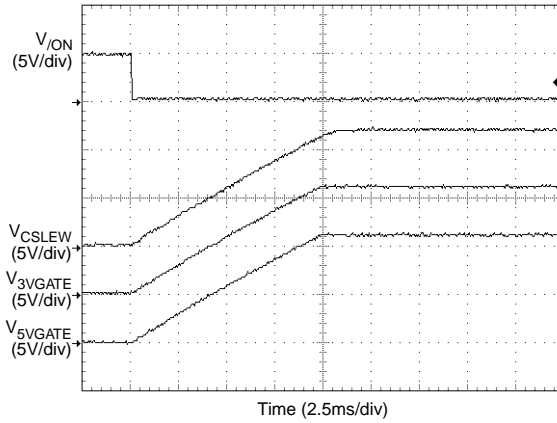

$C_{RST} = 0.01\mu F$
 $C_{SLEW} = 0.03\mu F$
 $C_{START} = 0.01\mu F$

Power-On Reset Response

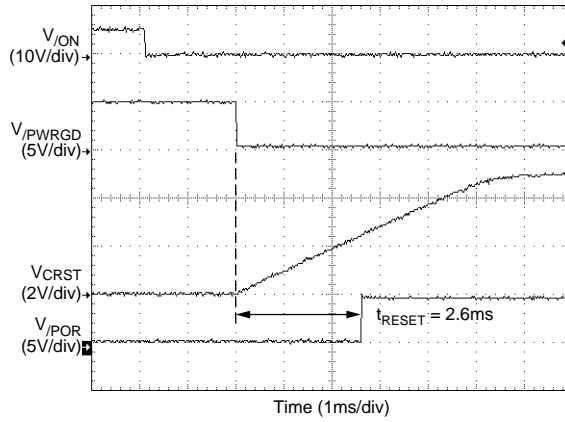

$C_{RST} = 0.01\mu F$

Power-Good Response

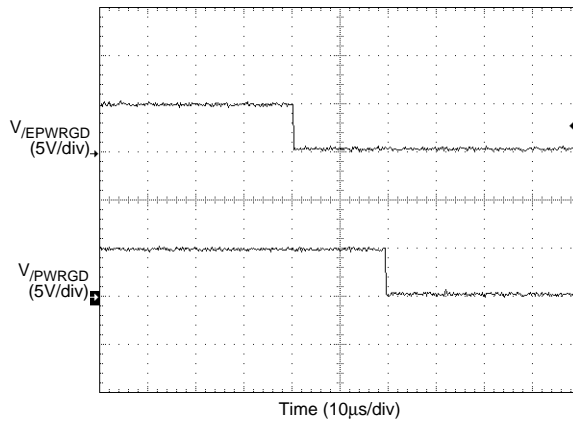

Local PCI Reset Response

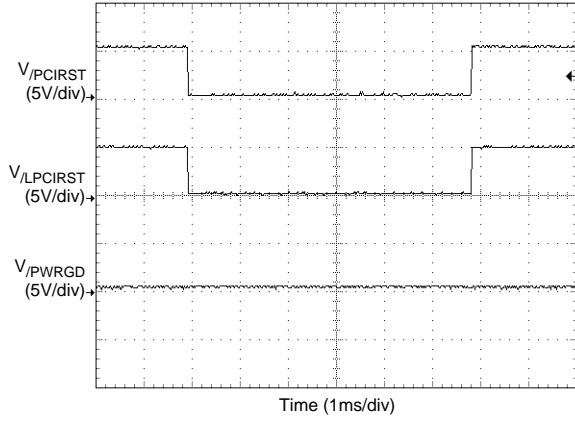

C_{RST} = 0.01μF

Fault Response

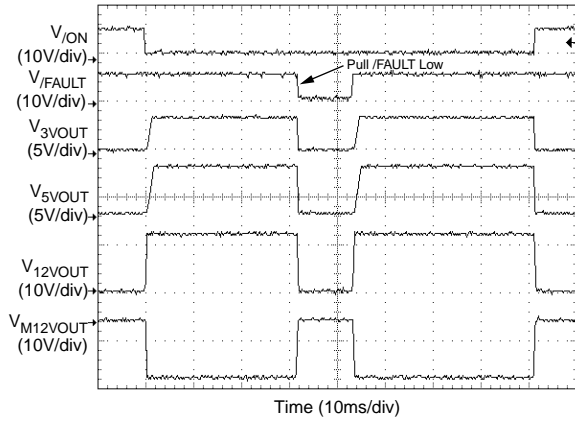

Turn-On and Turn-off

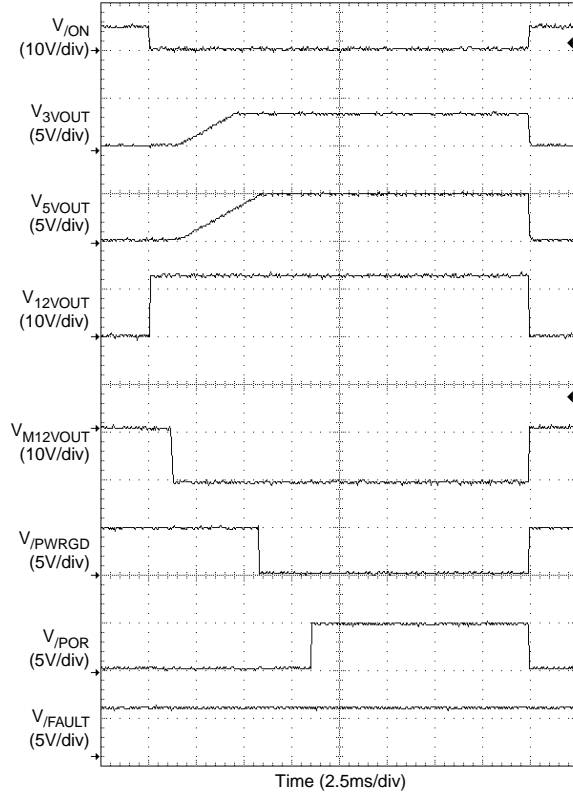

$C_{START} = 0.01\mu F$
 $C_{SLEW} = 0.03\mu F$
 $C_{RST} = 0.01\mu F$

-12V Turn-On

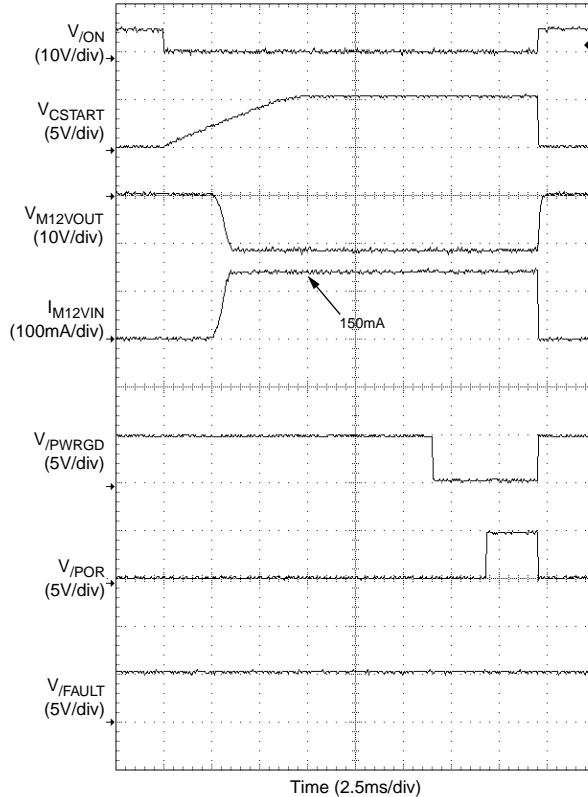

$C_{START} = 0.01\mu F$
 $C_{SLEW} = 0.07\mu F$
 $C_{RST} = 0.01\mu F$
 $C_{M12L} = 1\mu F$
 $R_{M12L} = 80\Omega$

3V Turn-On

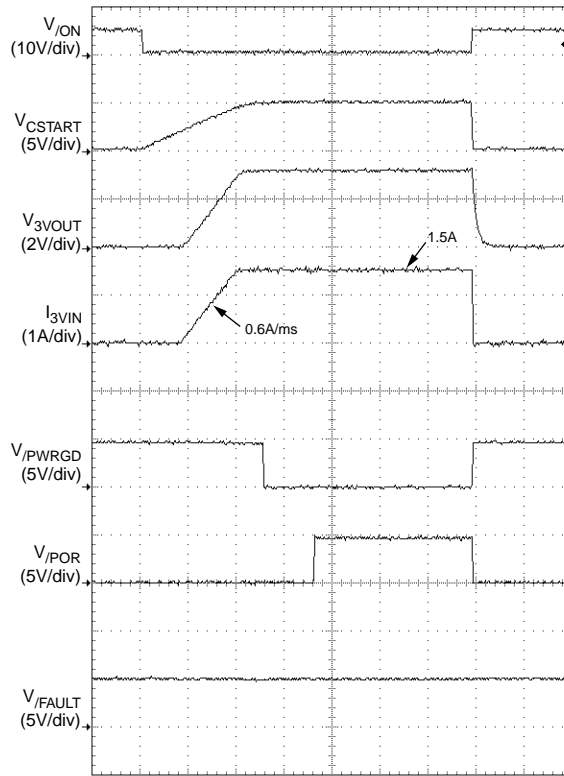

$C_{START} = 0.01\mu F$
 $C_{SLEW} = 0.03\mu F$
 $C_{RST} = 0.01\mu F$
 $C_{3L} = 100\mu F$
 $R_{3L} = 2.2\Omega$

Time (2.5ms/div)

5V Turn-On

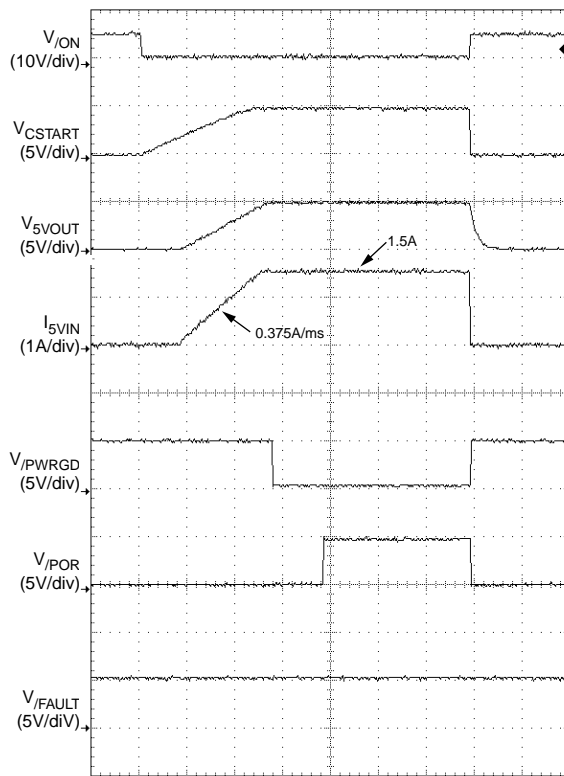

$C_{START} = 0.01\mu F$
 $C_{SLEW} = 0.03\mu F$
 $C_{RST} = 0.01\mu F$
 $C_{5L} = 100\mu F$
 $R_{5L} = 3.3\Omega$

Time (2.5ms/div)

12V Turn-On

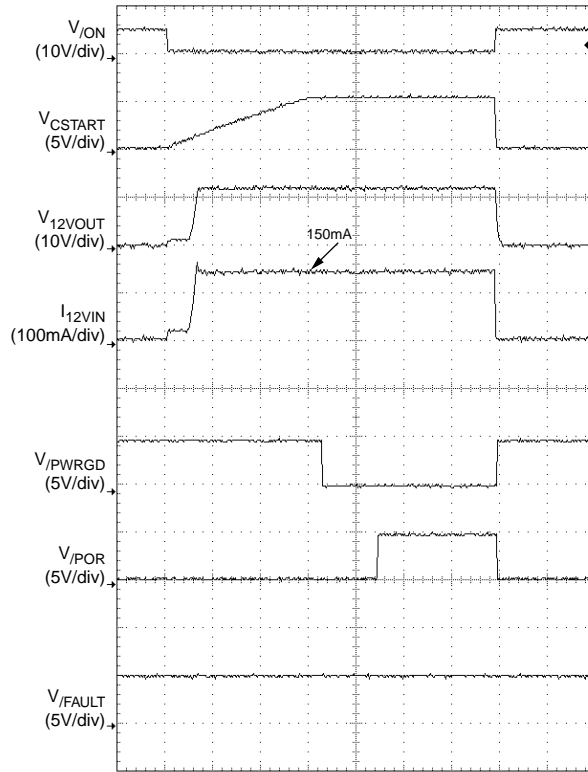

$C_{START} = 0.01\mu F$
 $C_{SLEW} = 0.04\mu F$
 $C_{RST} = 0.01\mu F$
 $C_{12L} = 1\mu F$
 $R_{12L} = 80\Omega$

**Enable Into
-12V-Output Short Circuit**

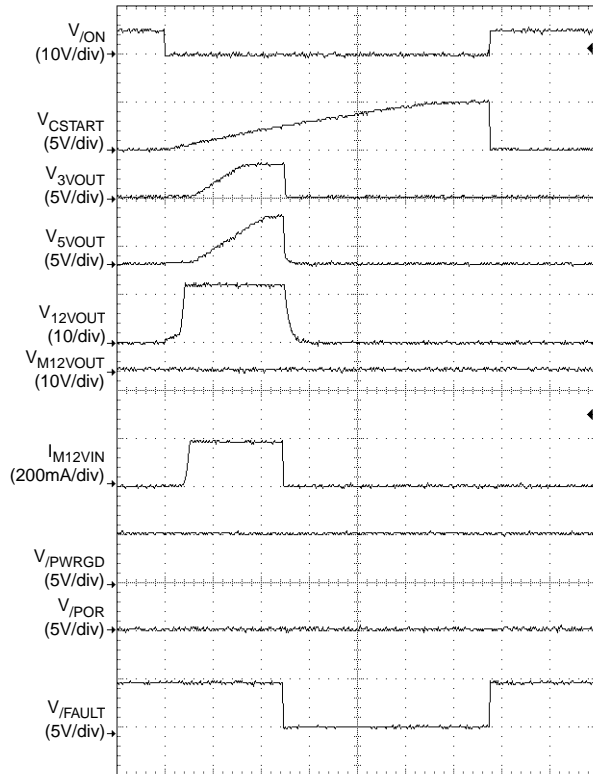

$C_{START} = 0.01\mu F$
 $C_{SLEW} = 0.01\mu F$
 $C_{RST} = 0.01\mu F$
 $R_{12L} = 100\Omega$
 $C_{12L} = 1\mu F$
 $M12VOUT = GND$

Time (1ms/div)

**Enable Into
3V-Output Short Circuit**

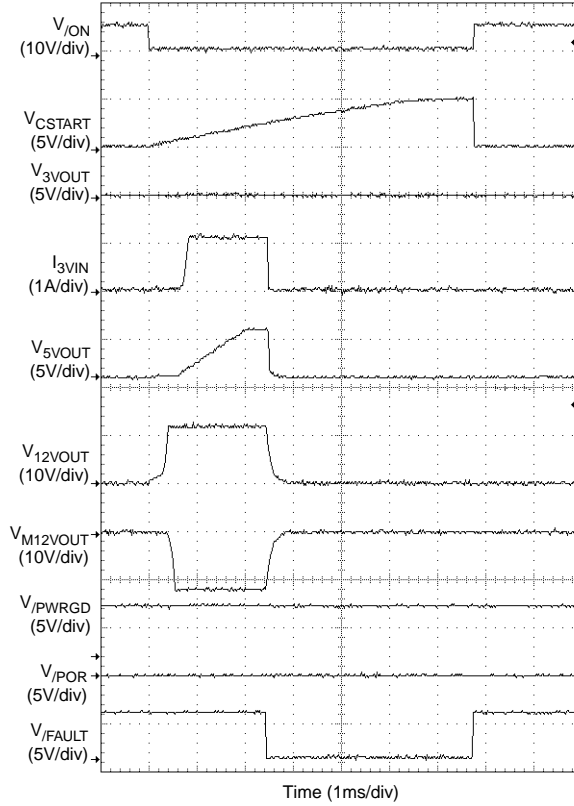

$C_{START} = 0.01\mu F$
 $C_{SLEW} = 0.01\mu F$
 $C_{RST} = 0.01\mu F$
 $3V_{OUT} = GND$
 $R_{12L} = 100\Omega$
 $C_{12L} = 1\mu F$
 $R_{M12L} = 100\Omega$
 $C_{M12L} = 1\mu F$

**Enable Into
5V-Output Short Circuit**

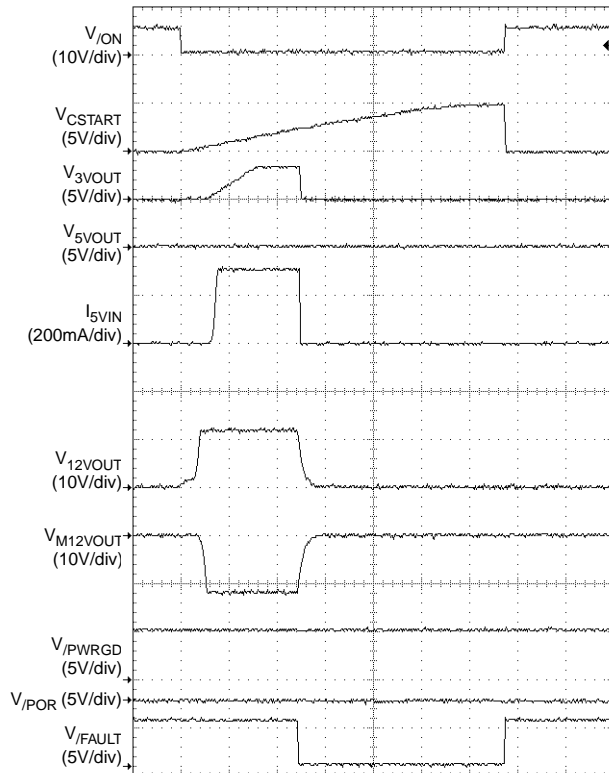

$C_{START} = 0.01\mu F$
 $C_{SLEW} = 0.01\mu F$
 $C_{RST} = 0.01\mu F$
 $R_{12L} = 100\Omega$
 $C_{12L} = 1\mu F$
 $R_{M12L} = 100\Omega$
 $C_{M12L} = 1\mu F$
 $5V_{OUT} = GND$

**Enable Into
12V-Output Short Circuit**

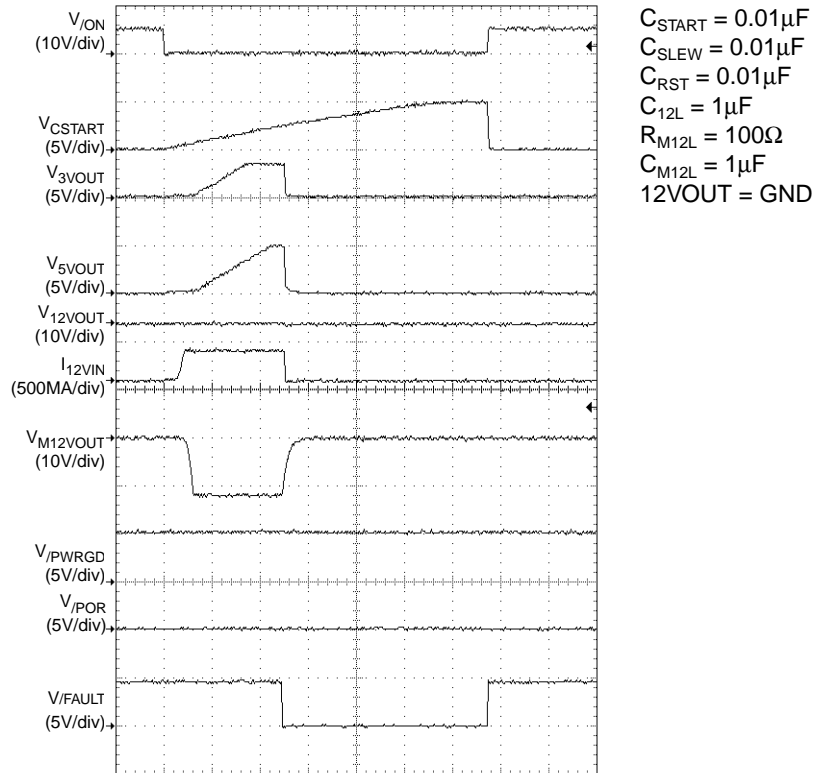

Start-up Blanking Response

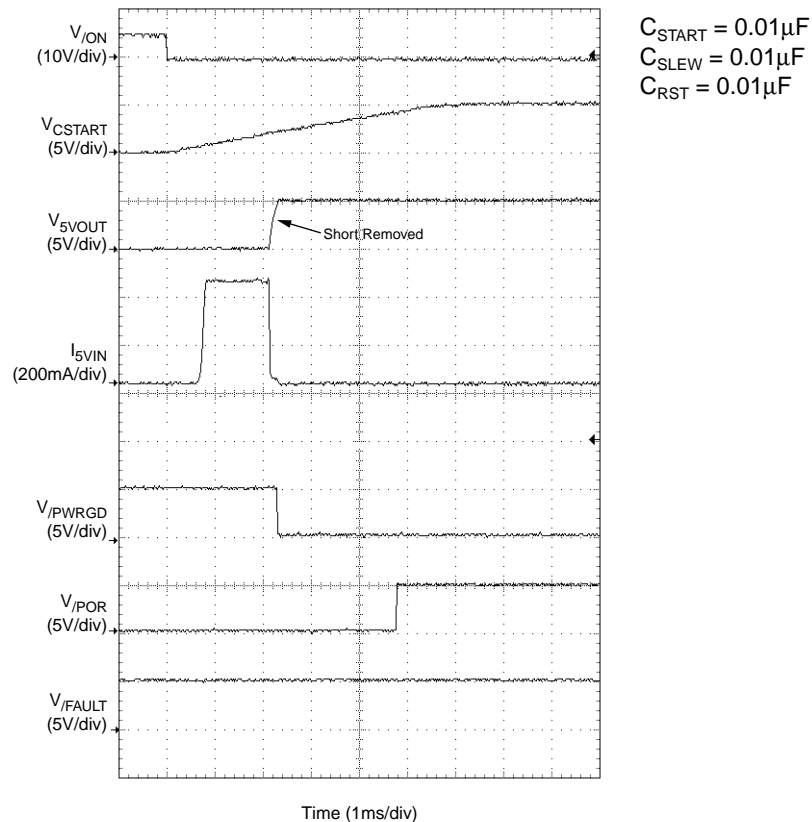

**Circuit Breaker
Reset Response**

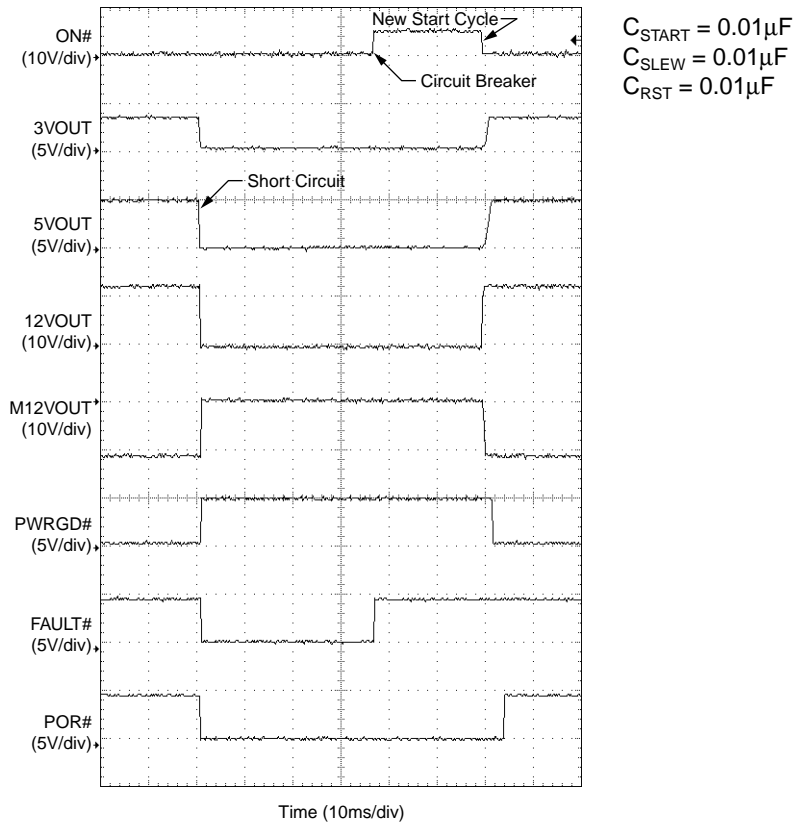

Functional Diagram

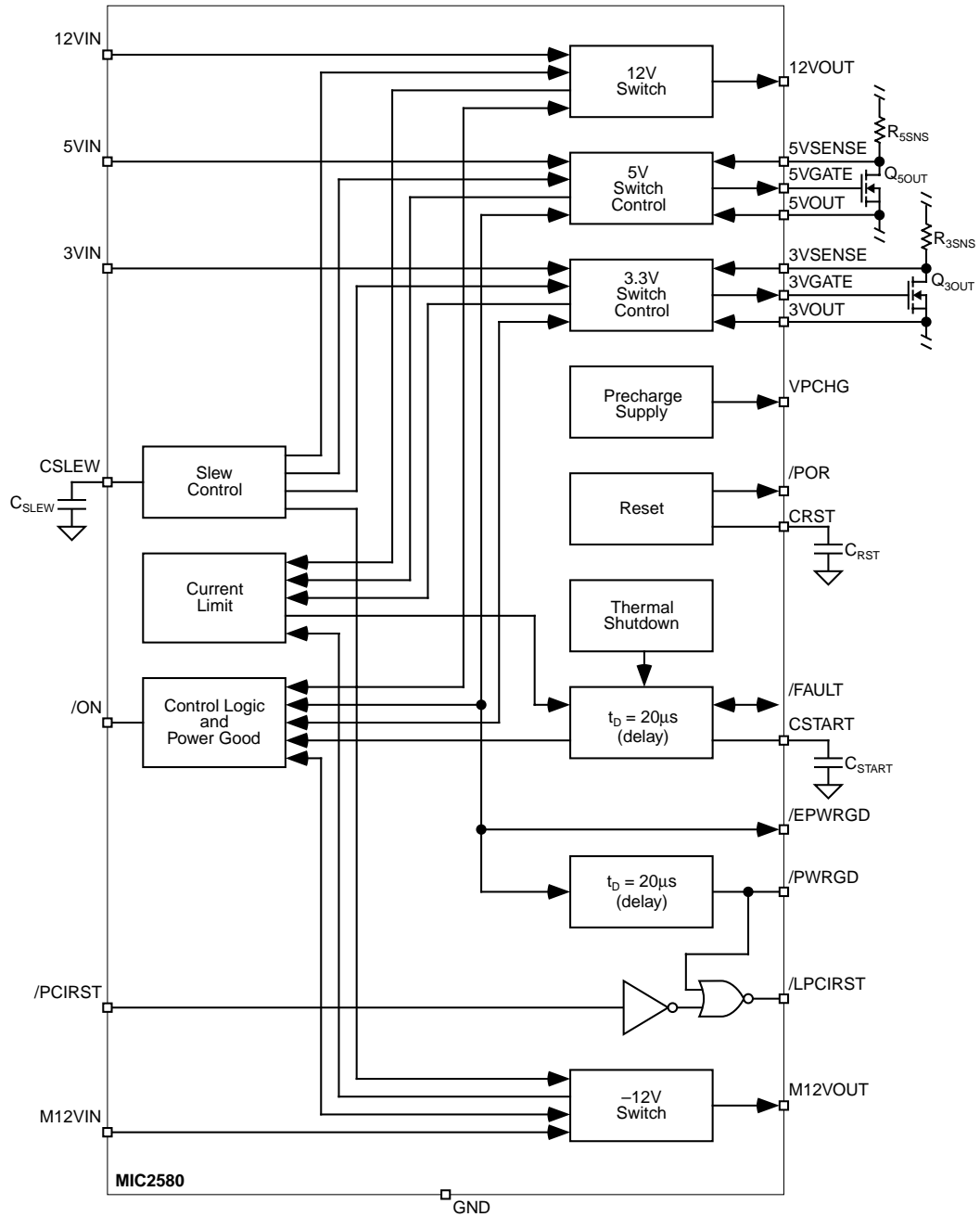

Functional Description

Start-Up Sequence

The start-up sequence is initiated when /ON is asserted and all four supplies are connected to the inputs. During the start-up sequence, all four gates ramp up at a rate determined by C_{SLEW} . During this time /PWRGD is deasserted until all four supplies are within specified levels. When /PWRGD is asserted the power-on-reset signal /POR timer begins. The time period is defined by C_{RST} . Refer to Figure 1 for a timing diagram of the signals during the start-up sequence.

During the start-up sequence, a current source charges C_{START} at a constant rate until a threshold voltage of 2.4V is reached. This period of time defines an interval during which overcurrent events are ignored. This prevents high inrush currents that normally occur when charging capacitance erroneously asserting /FAULT. The magnitude of the start-up time, t_{START} is defined by C_{START} .

The MIC2580 employs foldback current limiting that ensures the device starts up in current limit. This minimizes high inrush currents due to ramping a voltage into capacitance regardless of the size of the load capacitance.

Overcurrent Detection

The MIC2580 senses overcurrent via the use of external sense resistors for the 5V and 3.3V supply rails. When the sense voltage across these resistors is greater than or equal to 50mV an overcurrent condition is detected. Therefore the overcurrent set point is determined by $I_{LIMIT} = 50mV/R_{SENSE}$. For the +12V and -12V supply rails overcurrent detection is set internally at 1.3A and -0.5A respectively.

When an overcurrent condition is detected /FAULT is asserted only if the overcurrent condition lasts for a minimum time period of 10 μ s. This delay prevents spurious noise from the system erroneously tripping the circuit breaker and asserting /FAULT. Upon /FAULT being asserted an internal latch is set that immediately turns off all four supplies to prevent further damage to the system. Toggling /ON will reset the latch and initiate another start-up sequence. Figures 2 and 3 depict the timing for two fault conditions.

Thermal Shutdown

The +12V and -12V internal MOSFET switches are protected by current limit and overtemperature shutdown circuitry. When the die temperature exceeds 160°C, /FAULT is asserted and all supplies are shut off. The power dissipated in the MIC2580 is primarily due to the sum of current flowing through the internal MOSFET switches and, to a lesser extent, power dissipated due to the supply current. To compute the total power dissipation of the MIC2580 the following equation is used:

$$P_{D(total)} = P_{D(+12V \text{ switch})} + P_{D(-12V \text{ switch})} + P_{D(supplies)}$$

where:

$$P_{D(switches)} = R_{DS(on)} \times I_{OUT}^2$$

$$P_{D(supplies)} = V_{SUPPLY} \times I_{SUPPLY}$$

To relate this to operating junction temperature:

$$T_J = P_D \times \theta_{JA} + T_A$$

where:

T_A = ambient temperature

θ_{JA} = package thermal resistance

Precharge Voltage

For CompactPCI applications, the MIC2580-1.0BSM/BTS integrates a 1V \pm 20% voltage source that satisfies CompactPCI precharge requirements. The voltage source can provide up to 10mA. For higher current, the MIC2580-1.6BSM/BTS integrates a 1.6V \pm 20% voltage source to bias a NPN transistor.

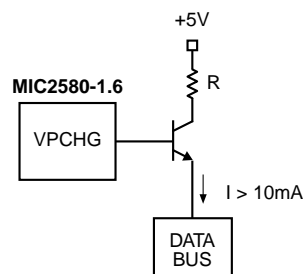

Figure 5. Voltage Source

Turnoff

Deasserting /ON will turn off all four supplies. Alternatively driving /FAULT low will turn off all supplies but will not latch the supplies off. Releasing /FAULT will initiate a new start sequence.

Application Information

Whenever voltage is applied to a highly capacitive load, high inrush currents may result in voltage droop that may bring the supply voltage out of regulation for the duration of the transient. The MIC2580 solves this problem by specifically controlling the current and voltage supply ramps so that the system supply voltages are not disturbed. Very large capacitive loads are easily supported with this device.

Figure 1 shows the timing during turn-on. When /ON is forced low, all supplies are turned on at a slew rate determined by the external capacitor, C_{SLEW} .

Figure 4 shows the foldback characteristics for the supply voltages. This foldback affect bounds the magnitude of the current step when the supplies are turned on or shorted. This specifies the compact PCI specification of 1.5A/ms, thereby ensuring reliable operation. In discrete FET implementations, this magnitude can exceed several amps and may cause the main supply to go out of regulation during this transient event. This, in turn, could cause the system to behave unpredictably. In addition, should a fault occur, the MIC2580 will prevent system malfunctions by limiting the current to within specifications.

MOSFET Selection

The external MOSFET should be selected to provide low enough dc loss to satisfy the application's voltage regulation requirements. Note that the voltage across the sense resistor

must also be added to the dc voltage drop across the MOSFET to compute total loss. In addition to meeting the voltage regulation specifications, thermal specifications must also be considered. During normal operation very little power should be dissipated in the MOSFET. DC power dissipation of the MOSFET is easily computed as I^2R_{DS} where I is the drain current and R_{DS} is the specified on-resistance of the MOSFET at the expected operating drain current. However, during excessive drain current or short-circuit faults, the power dissipation in the external MOSFET will increase dramatically. To help compute the effective power dissipated during such transients, MOSFET manufacturers provide transient thermal impedance curves for each MOSFET. These curves provide the effective thermal impedance of the MOSFET under pulsed or repetitive conditions; for example, as will be the case when enabling into a short circuit fault. From these curves the effective rise in junction temperature of the MOSFET for a given condition can be computed. The equation is given as:

$$\text{peak } T_J = PDM \times Z_{\theta JA} + T_A$$

where PDM is the power dissipated in the MOSFET usually computed as $V_{IN} \times I_{DRAIN}$ and $Z_{\theta JA}$ is the thermal response factor provided from the curves. Since the MIC2580 reduces the current to 30% of full scale even under severe faults such as short-circuits the MOSFET power dissipation is held to safe levels. This feature allows MOSFETs with smaller packages to be used for a given application thereby reducing cost and PCB real-estate requirements.

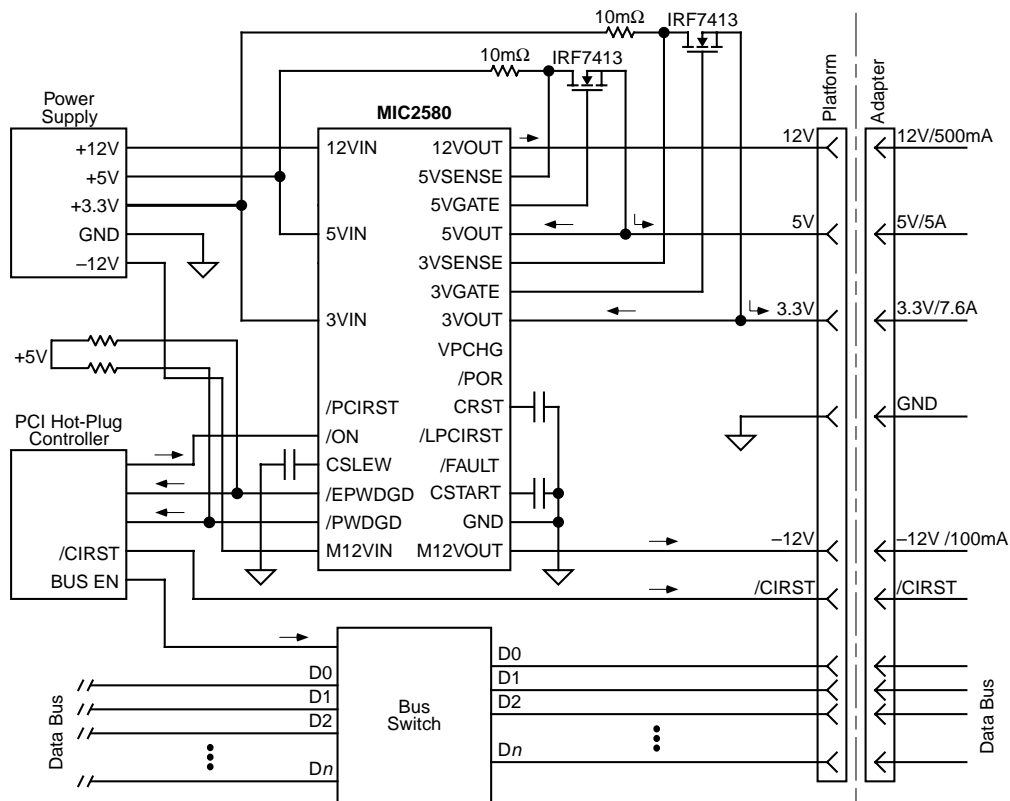

Figure 5. Hot-Plug PCI Application

CompactPCI™ BD_SEL# Pin Tied to Ground

For applications that use system backplanes with the BD_SEL# pin tied to ground, the MIC2580 /ON pin is edge sensitive. Therefore, the /ON pin requires a delay circuit for proper start-up when the board has already been inserted into the backplane and the supplies are switched off, then back on. The circuit, shown in the figure below, allows the MIC2580 /ON pin to transition from high to low which is necessary for start-up. The delay time may be increased or decreased by changing the capacitor value in the circuit, but the delay time must exceed the ramp time of all system backplane supplies.

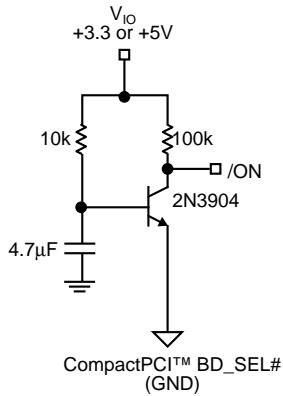

Figure 6. /ON Pin Assertion Delay Circuit

PCB Layout Considerations

To achieve accurate current sensing Kelvin connections are recommended between the supply pin and the respective sense resistor as shown in Figure 4. PCB trace length should be kept at a minimum. 0.02 inches per ampere is a minimum width for 1 oz. copper to prevent damage to traces carrying high current. Keep these high-current traces as short as possible.

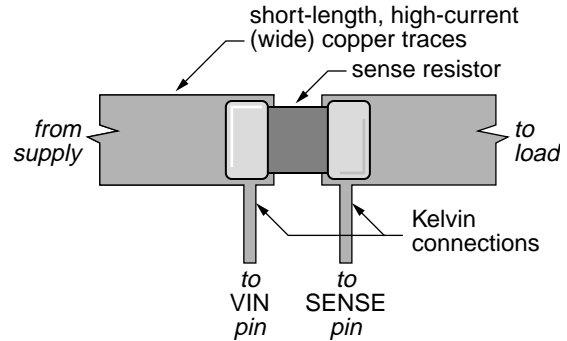
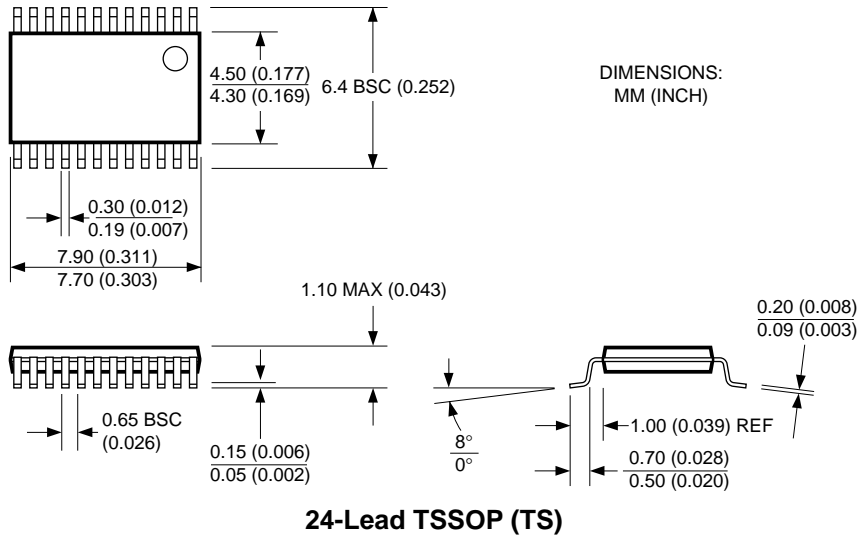

Figure 7. Layout Recommendation

Package Information



MICREL INC. 1849 FORTUNE DRIVE SAN JOSE, CA 95131 USA

TEL + 1 (408) 944-0800 FAX + 1 (408) 944-0970 WEB <http://www.micrel.com>

This information is believed to be accurate and reliable, however no responsibility is assumed by Micrel for its use nor for any infringement of patents or other rights of third parties resulting from its use. No license is granted by implication or otherwise under any patent or patent right of Micrel Inc.

© 2001 Micrel Incorporated