

## Hinged frame HMC 16B f. 4 modules (a..d)

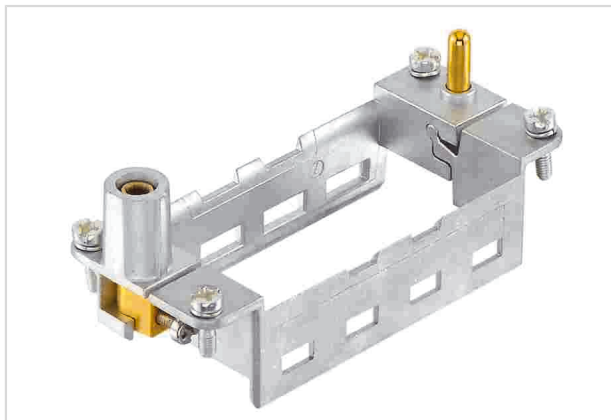

Image is for illustration purposes only. Please refer to product description.

Part number	09 14 216 0313
Specification	Hinged frame HMC 16B f. 4 modules (a..d)
HARTING eCatalogue	<a href="https://b2b.harting.com/09142160313">https://b2b.harting.com/09142160313</a>

### Identification

Category	Accessories
Series	Han-Modular®
Type of accessory	Hinged frame
Description of the accessory	HMC version for 4 modules a ... d
Features	Conductor cross-section PE (power side) 4 ... 10 mm <sup>2</sup> Conductor cross-section PE (signal side) 1 ... 2.5 mm <sup>2</sup>

### Version

Size	16 B
------	------

### Technical characteristics

Limiting temperature	-40 ... +125 °C
Mating cycles with other HMC components	≥10,000

### Material properties

Material	Zinc die-cast
RoHS	compliant with exemption
RoHS exemptions	6(c): Copper alloy containing up to 4 % lead by weight
ELV status	compliant with exemption
China RoHS	50
REACH Annex XVII substances	Not contained
REACH ANNEX XIV substances	Not contained



**Pushing Performance**  
Since 1945

## Material properties

REACH SVHC substances	Yes
REACH SVHC substances	Lead
ECHA SCIP number	564b7d75-7bf6-4cfb-acb1-2168eb61b675
California Proposition 65 substances	Yes
California Proposition 65 substances	Lead Nickel

## Specifications and approvals

Specifications	IEC 60664-1 IEC 61984
UL / CSA	UL 1977 ECBT2.E235076

## Commercial data

Packaging size	2
Net weight	67.8 g
Country of origin	Germany
European customs tariff number	85389099
GTIN	5713140021549
eCl@ss	27440206 Module carrier frame for industrial connectors