

NC7S32 TinyLogic™ HS 2-Input OR Gate

General Description

The NC7S32 is a single 2-Input high performance CMOS OR Gate. Advanced Silicon Gate CMOS fabrication assures high speed and low power circuit operation over a broad V_{CC} range. ESD protection diodes inherently guard both inputs and output with respect to the V_{CC} and GND rails. Three stages of gain between inputs and outputs assures high noise immunity and reduced sensitivity to input edge rate.

Features

- Space saving SOT23 or SC70 5-lead surface mount package
- High Speed; T_{PD} 3.5 ns typ
- Low Quiescent Power; $I_{CC} < 1 \mu A$
- Balanced Output Drive; 2 mA I_{OL} , -2 mA I_{OH}
- Broad V_{CC} Operating Range: 2V–6V
- Balanced Propagation Delays
- Specified for 3V Operation

Ordering Code:

Product Code	Package	Package Drawing	Package Top Mark	Supplied As
NC7S32M5	SOT23-5	MA05B	7S32	250 Units on Tape and Reel
NC7S32M5X	SOT23-5	MA05B	7S32	3k Units on Tape and Reel
NC7S32P5	SC70-5	MAA05A	S32	250 Units on Tape and Reel
NC7S32P5X	SC70-5	MAA05A	S32	3k Units on Tape and Reel

Logic Symbol

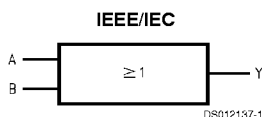

Connection Diagram

Pin Assignment for 5-lead Packages

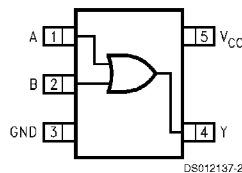

(Top View)

Pin Descriptions

Pin Names	Description
A, B	Inputs
Y	Output

Function Table

$$Y = A + B$$

Inputs		Output
A	B	Y
L	L	L
L	H	H
H	L	H
H	H	H

H = HIGH Logic Level
L = LOW Logic Level

Absolute Maximum Ratings (Note 1)

Supply Voltage (V_{CC})	-0.5V to +7.0V
DC Input Diode Current (I_{IK})	
@ $V_{IN} \leq -0.5V$	-20 mA
@ $V_{IN} \geq V_{CC} + 0.5V$	+20 mA
DC Input Voltage (V_{IN})	-0.5V to $V_{CC} + 0.5V$
DC Output Diode Current (I_{OK})	
@ $V_{OUT} < -0.5V$	-20 mA
@ $V_{OUT} > V_{CC} + 0.5V$	+20 mA
DC Output Voltage (V_{OUT})	-0.5V to $V_{CC} + 0.5V$
DC Output Source or Sink Current (I_{OUT})	± 12.5 mA
DC V_{CC} or Ground Current per Output Pin (I_{CC} or I_{GND})	± 25 mA
Storage Temperature (T_{STG})	-65°C to +150°C
Junction Temperature (T_J)	150°C
Lead Temperature (T_L) (Soldering, 10 seconds)	260°C
Power Dissipation (P_D) @ +85°C	
SOT23-5	200 mW
SC70-5	150 mW
ESD Tolerance (Human Body Model)	
MIL-STD-883D Method 3015.7	>1000V

DC Latchup Tolerance
Source Current
(JEDEC Method 17)

± 500 mA

Recommended Operating Conditions

Supply Voltage (V_{CC})	2.0V to 6.0V
Input Voltage (V_{IN})	0V to V_{CC}
Output Voltage (V_{OUT})	0V to V_{CC}
Operating Temperature (T_A)	-40°C to +85°C
Input Rise and Fall Time (t_r, t_f)	
V_{CC} @ 2.0V	0 to 1000 ns
V_{CC} @ 3.0V	0 to 750 ns
V_{CC} @ 4.5V	0 to 500 ns
V_{CC} @ 6.0V	0 to 400 ns
Thermal Resistance (θ_{JA})	
SOT23-5	300°C/W
SC70-5	425°C/W

Note 1: Absolute maximum ratings are those values beyond which damage to the device may occur. The databook specifications should be met, without exception, to ensure that the system design is reliable over its power supply, temperature, and output/input loading variables. Fairchild does not recommend operation of circuits outside the databook specifications.

DC Electrical Characteristics

Symbol	Parameter	V_{CC} (V)	NC7S32			NC7S32		Units	Condition
			$T_A = +25^\circ\text{C}$			$T_A = -40^\circ\text{C to } +85^\circ\text{C}$			
			Min	Typ	Max	Min	Max		
V_{IH}	High Level Input Voltage	2.0 3.0-6.0	1.50 0.7 V_{CC}			1.50 0.7 V_{CC}	V		
V_{IL}	Low Level Input Voltage	2.0 3.0-6.0		0.50 0.3 V_{CC}		0.50 0.3 V_{CC}	V		
V_{OH}	High Level Output Voltage	2.0 3.0 4.5 6.0	1.90 2.90 4.40 5.90	2.0 3.0 4.5 6.0		1.90 2.90 4.40 5.90	V	$I_{OH} = -20$ mA $V_{IN} = V_{IH}$	
		3.0 4.5 6.0	2.68 4.18 5.68	2.85 4.35 5.85		2.63 4.13 5.63	V	$V_{IN} = V_{IH}$ $I_{OH} = -1.3$ mA $I_{OH} = -2$ mA $I_{OH} = -2.6$ mA	
V_{OL}	Low Level Output Voltage	2.0 3.0 4.5 6.0		0.0 0.0 0.0 0.1		0.10 0.10 0.10 0.10	V	$I_{OL} = 20$ μ A $V_{IN} = V_{IL}$	
		3.0 4.5 6.0		0.1 0.1 0.1		0.33 0.33 0.33	V	$V_{IN} = V_{IL}$ $I_{OL} = 1.3$ mA $I_{OL} = 2$ mA $I_{OL} = 2.6$ mA	
I_{IN}	Input Leakage Current	6.0		± 0.1		± 1.0	μ A	$V_{IN} = V_{CC}, GND$	
I_{CC}	Quiescent Supply Current	6.0		1.0		10.0	μ A	$V_{IN} = V_{CC}, GND$	

AC Electrical Characteristics

Symbol	Parameter	V _{CC} (V)	NC7S32			NC7S32		Units	Conditions
			T _A = +25° C			T _A = -40° C to +85° C			
			Min	Typ	Max	Min	Max		
t _{PLH} , t _{PHL}	Propagation Delay	5.0	3.5	15			ns	C _L = 15 pF	
		2.0	20	100		125	ns	C _L = 50 pF	
		3.0	12	27		35			
		4.5	8	20		25			
		6.0	7	17		21			
t _{TLH} , t _{THL}	Output Transition Time	5.0	3.0	10			ns	C _L = 15 pF	
		2.0	25	125		155	ns	C _L = 50 pF	
		3.0	16	35		45			
		4.5	11	25		31			
		6.0	9	21		26			
C _{IN}	Input Capacitance (Note 2)	Open	2	10		10	pF		
C _{PD}	Power Dissipation Capacitance	5.0	6				pF	(Note 3)	

Note 2: Parameter guaranteed by design. Not tested.

Note 3: C_{PD} is defined as the value of the internal equivalent capacitance which is derived from dynamic operating current consumption (I_{CCD}) at no output loading and operating at 50% duty cycle. (See Figure 2.) C_{PD} is related to I_{CCD} dynamic operating current by the expression: I_{CCD} = (C_{PD}) (V_{CC}) (f_{IN}) + (I_{CCstatic}).

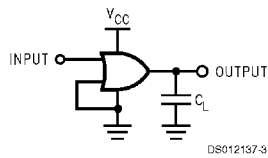

DS012137-3

C_L includes load and stray capacitance
Input PRR = 1.0 MHz, t_w = 500 ns

FIGURE 1. AC Test Circuit

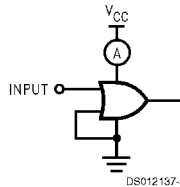

DS012137-5

Input = AC Waveforms;
PRR = variable; Duty Cycle = 50%

FIGURE 2. I_{CCD} Test Circuit

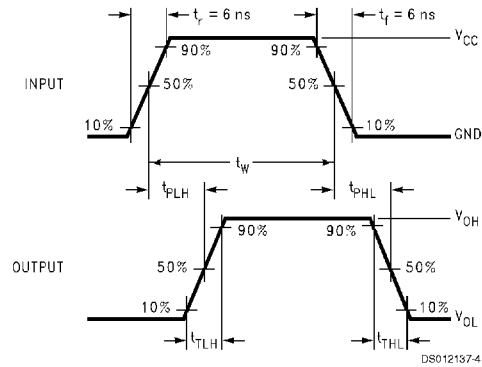

DS012137-4

FIGURE 3. AC Waveforms

Ordering Information

The device number is used to form part of a simplified purchasing code where the package type and temperature range are defined as follows:

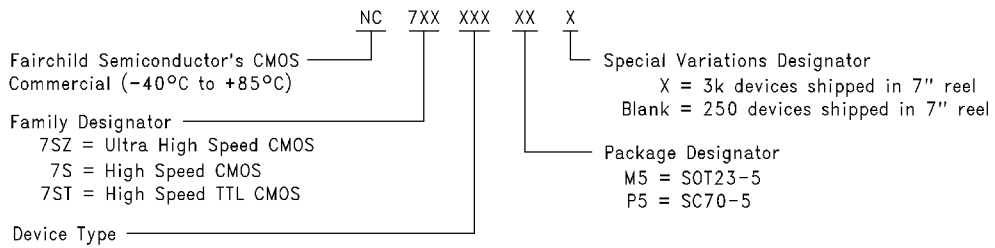

DS012137-6

Tape and Reel Specification

TAPE FORMAT

Package Designator	Tape Section	Number Cavities	Cavity Status	Cover Tape Status
M5, P5	Leader (Start End)	125 (typ)	Empty	Sealed
	Carrier	250	Filled	Sealed
	Trailer (Hub End)	75 (typ)	Empty	Sealed
M5X, P5X	Leader (Start End)	125 (typ)	Empty	Sealed
	Carrier	3000	Filled	Sealed
	Trailer (Hub End)	75 (typ)	Empty	Sealed

TAPE DIMENSIONS inches (millimeters)

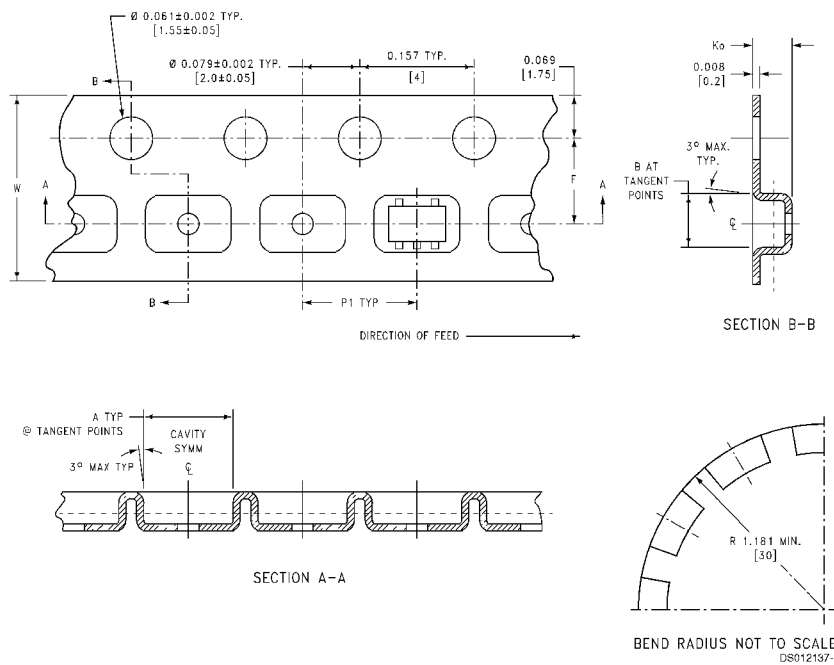

Pkg	Tape Size	DIM A	DIM B	DIM F	DIM K_0	DIM P1	DIM W
SC70-5	8 mm	0.093 (2.35)	0.096 (2.45)	0.138 ± 0.004 (3.5 ± 0.10)	0.053 ± 0.004 (1.35 ± 0.10)	0.157 (4)	0.315 ± 0.004 (8 ± 0.1)
SOT23-5	8 mm	0.130 (3.3)	0.130 (3.3)	0.138 ± 0.002 (3.5 ± 0.05)	0.055 ± 0.004 (1.4 ± 0.11)	0.157 (4)	0.315 ± 0.012 (8 ± 0.3)

Tape and Reel Specification

(Continued)

REEL DIMENSIONS inches (millimeters)

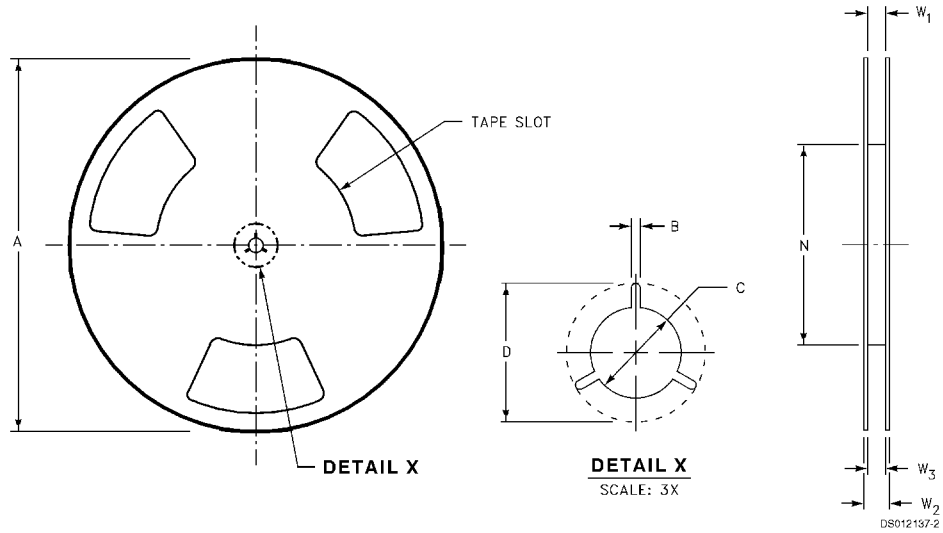

Tape Size	A	B	C	D	N	W1	W2	W3
8 mm	7.0 (177.8)	0.059 (1.50)	0.512 (13.00)	0.795 (20.20)	2.165 (55.00)	0.331 +0.059/-0.000 (8.40 +1.50/-0.00)	0.567 (14.40)	W1 +0.078/-0.039 (W1 +2.00/-1.00)

Physical Dimensions inches (millimeters) unless otherwise noted

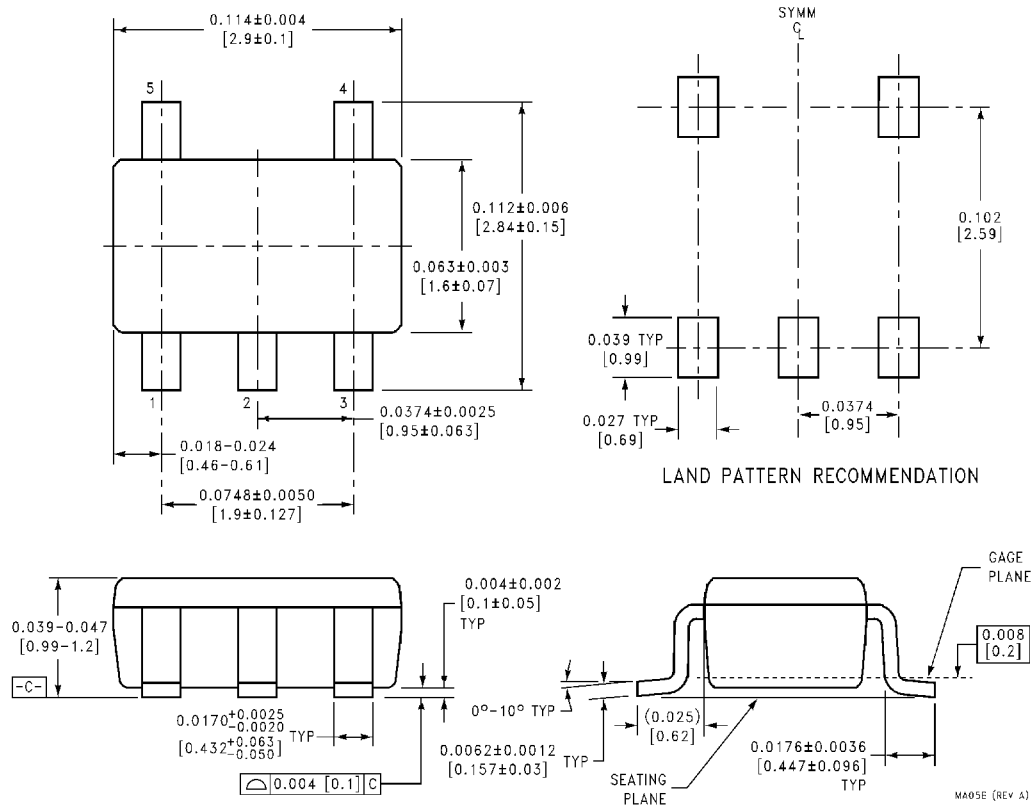

5-Lead Molded SOT23, Enhanced Thermal Package Number MA05B

MA05B (REV A)

Physical Dimensions inches (millimeters) unless otherwise noted (Continued)

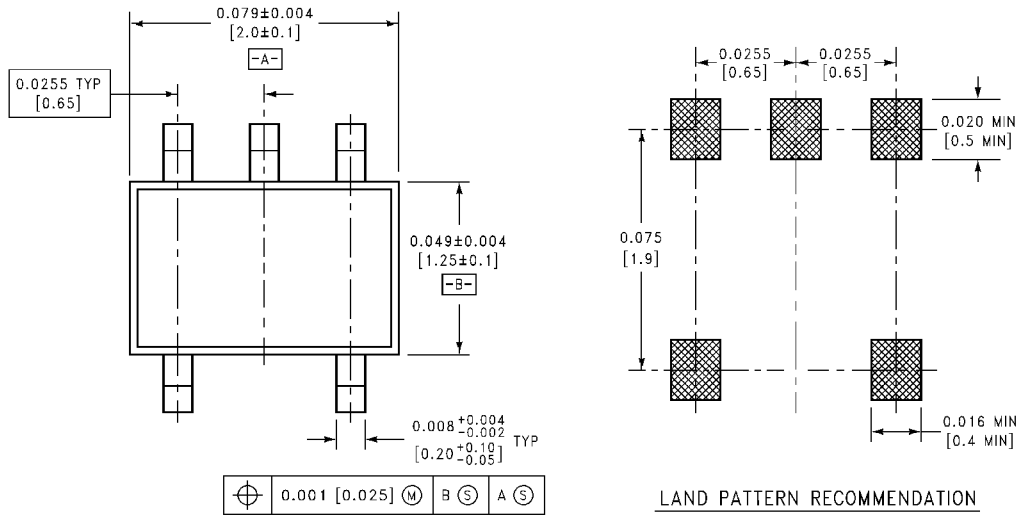

5-Lead Molded SC70, Enhanced Thermal Package Number MAA05A

MAA05A (REV B)

LIFE SUPPORT POLICY

FAIRCHILD'S PRODUCTS ARE NOT AUTHORIZED FOR USE AS CRITICAL COMPONENTS IN LIFE SUPPORT DEVICES OR SYSTEMS WITHOUT THE EXPRESS WRITTEN APPROVAL OF THE PRESIDENT OF FAIRCHILD SEMICONDUCTOR CORPORATION. As used herein:

1. Life support devices or systems are devices or systems which, (a) are intended for surgical implant into the body, or (b) support or sustain life, and (c) whose failure to perform when properly used in accordance with instructions for use provided in the labeling, can be reasonably expected to result in a significant injury to the user.
2. A critical component in any component of a life support device or system whose failure to perform can be reasonably expected to cause the failure of the life support device or system, or to affect its safety or effectiveness.

Fairchild Semiconductor Corporation
Americas
Customer Response Center
Tel: 1-888-522-5372

Fairchild Semiconductor Europe
Fax: +49 (0) 1 80-530 85 86
Email: europe.support@nsc.com
Deutsch Tel: +49 (0) 8 141-35-0
English Tel: +44 (0) 1 793-85-68-56
Italy Tel: +39 (0) 2 57 5631

Fairchild Semiconductor Hong Kong Ltd.
13th Floor, Straight Block,
Ocean Centre, 5 Canton Rd.
Tsimshatsui, Kowloon
Hong Kong
Tel: +852 2737-7200
Fax: +852 2314-0061

National Semiconductor Japan Ltd.
Tel: 81-3-5620-6175
Fax: 81-3-5620-6179

www.fairchildsemi.com