

DM74LS26 Quad 2-Input NAND Gates with High Voltage Open-Collector Outputs

General Description

This device contains four independent gates each of which performs the logic NAND function. The open-collector outputs require external pull-up resistors for proper logical operation.

These gates feature high-voltage output ratings (up to 15V) for interfacing with 12V systems. Although the outputs are rated for 15V, the device supply is still rated for 5V.

Pull-Up Resistor Equations

$$R_{MAX} = \frac{V_O (Min) - V_{OH}}{N_1 (I_{OH}) + N_2 (I_{IH})}$$

$$R_{MIN} = \frac{V_O (Max) - V_{OL}}{I_{OL} - N_3 (I_{IL})}$$

Where: $N_1 (I_{OH})$ = total maximum output high current for all outputs tied to pull-up resistor

$N_2 (I_{IH})$ = total maximum input high current for all inputs tied to pull-up resistor

$N_3 (I_{IL})$ = total maximum input low current for all inputs tied to pull-up resistor

Connection Diagram

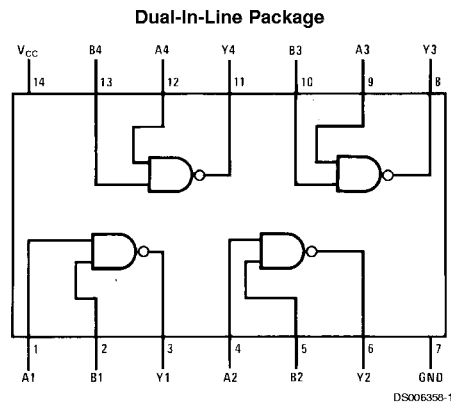

Order Number DM54LS26J, DM74LS26M, DM74LS26N or DM54LS26W
See Package Number J14A, M14A, N14A or W14B

Function Table

$$Y = \overline{AB}$$

Inputs		Output
A	B	Y
L	L	H
L	H	H
H	L	H
H	H	L

H = High Logic Level
L = Low Logic Level

Absolute Maximum Ratings (Note 1)

Supply Voltage	7V	DM54LS	-55°C to +125°C
Input Voltage	7V	DM74LS	0°C to +70°C
Output Voltage	15V	Storage Temperature Range	-65°C to +150°C

Operating Free Air Temperature Range

Recommended Operating Conditions

Symbol	Parameter	DM54LS26			DM74LS26			Units
		Min	Nom	Max	Min	Nom	Max	
V _{CC}	Supply Voltage	4.5	5	5.5	4.75	5	5.25	V
V _{IH}	High Level Input Voltage	2			2			V
V _{IL}	Low Level Input Voltage			0.7			0.8	V
V _{OH}	High Level Output Voltage			15			15	V
I _{OL}	Low Level Output Current			4			8	mA
T _A	Free Air Operating Temperature	-55		125	0		70	°C

Note 1: The "Absolute Maximum Ratings" are those values beyond which the safety of the device cannot be guaranteed. The device should not be operated at these limits. The parametric values defined in the "Electrical Characteristics" table are not guaranteed at the absolute maximum ratings. The "Recommended Operating Conditions" table will define the conditions for actual device operation.

Electrical Characteristics

over recommended operating free air temperature range (unless otherwise noted)

Symbol	Parameter	Conditions	Min	Typ (Note 2)	Max	Units
V _I	Input Clamp Voltage	V _{CC} = Min, I _I = -18 mA			-1.5	V
I _{OEX}	High Level Output Current	V _{CC} = Min V _{IL} = Max	V _O = 15V V _O = 12V		1000 50	μA
V _{OL}	Low Level Output Voltage	V _{CC} = Min, I _{OL} = Max V _{IH} = Min I _{OL} = 4 mA, V _{CC} = Min	DM54 DM74	0.35 0.25	0.4 0.5 0.4	V
I _I	Input Current @ Max Input Voltage	V _{CC} = Max, V _I = 7V V _I = 5.5V	DM74 DM54		0.1	mA
I _{IH}	High Level Input Current	V _{CC} = Max, V _I = 2.7V			20	μA
I _{IL}	Low Level Input Current	V _{CC} = Max, V _I = 0.4V	DM54 DM74		-0.40 -0.36	mA
I _{OCH}	Supply Current with Outputs High	V _{CC} = Max		0.8	1.6	mA
I _{OCL}	Supply Current with Outputs Low	V _{CC} = Max		2.4	4.4	mA

Switching Characteristics

at V_{CC} = 5V and T_A = 25°C

Symbol	Parameter	DM54		DM74				Units
		R _L = 2 kΩ		R _L = 2 kΩ				
		C _L = 15 pF		C _L = 15 pF		C _L = 50 pF		
		Min	Max	Min	Max	Min	Max	
t _{PLH}	Propagation Delay Time Low to High Level Output		27		20		45	ns
t _{PHL}	Propagation Delay Time High to Low Level Output		18		15		20	ns

Note 2: All typicals are at V_{CC} = 5V, T_A = 25°C.

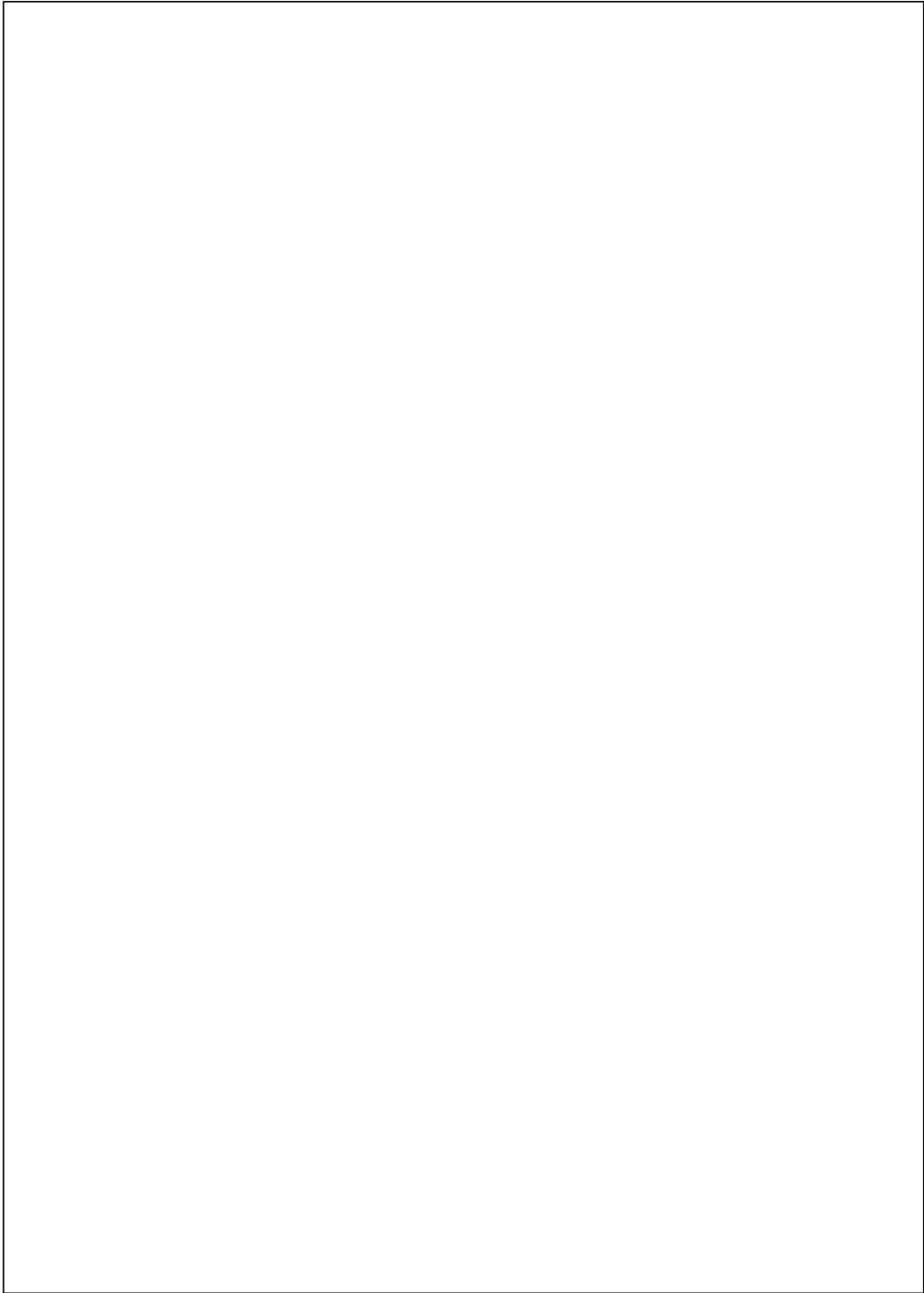

Physical Dimensions inches (millimeters) unless otherwise noted

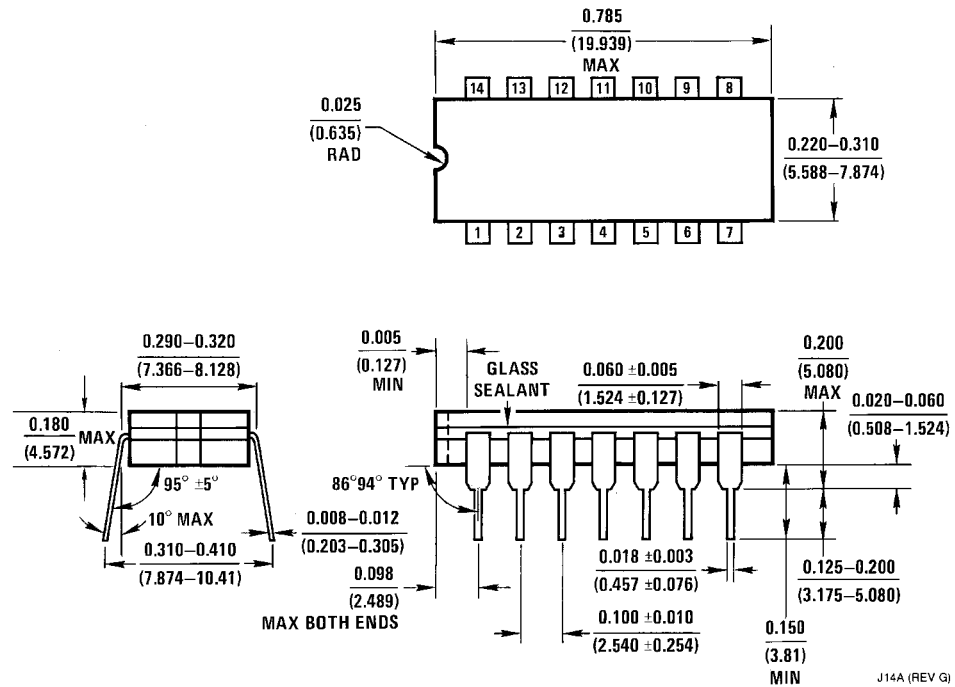

14-Lead Ceramic Dual-In-Line Package (J)
 Order Number DM54LS26J
 Package Number J14A

J14A (REV G)

Physical Dimensions inches (millimeters) unless otherwise noted (Continued)

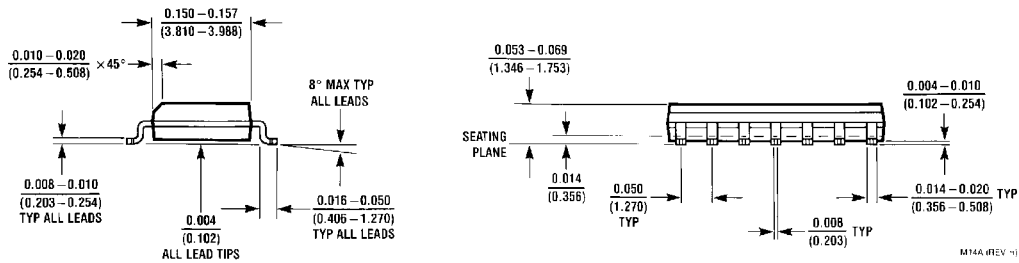
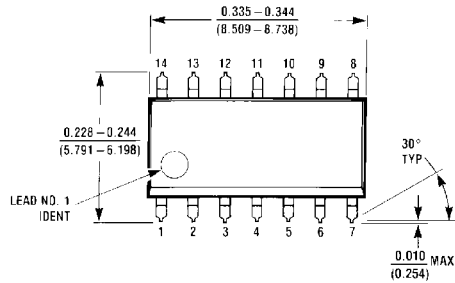

14-Lead Small Outline Molded Package (M)
Order Number DM74LS26M
Package Number M14A

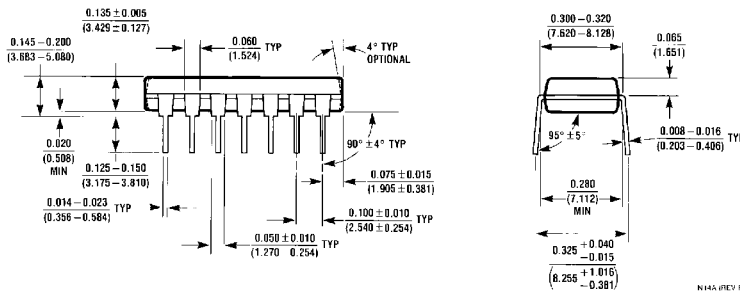
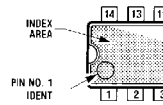
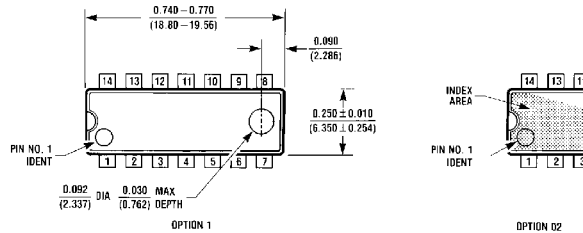

14-Lead Molded Dual-In-Line Package (N)
Order Number DM74LS26N
Package Number N14A

Physical Dimensions inches (millimeters) unless otherwise noted (Continued)

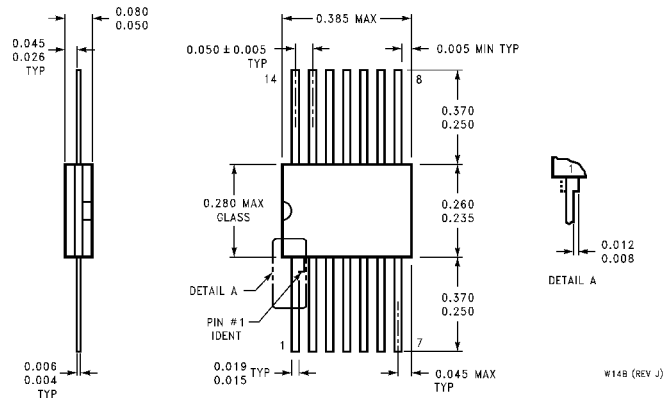

14-Lead Ceramic Flat Package (W)
Order Number DM54LS26W
Package Number W14B

LIFE SUPPORT POLICY

FAIRCHILD'S PRODUCTS ARE NOT AUTHORIZED FOR USE AS CRITICAL COMPONENTS IN LIFE SUPPORT DEVICES OR SYSTEMS WITHOUT THE EXPRESS WRITTEN APPROVAL OF THE PRESIDENT OF FAIRCHILD SEMICONDUCTOR CORPORATION. As used herein:

1. Life support devices or systems are devices or systems which, (a) are intended for surgical implant into the body, or (b) support or sustain life, and (c) whose failure to perform when properly used in accordance with instructions for use provided in the labeling, can be reasonably expected to result in a significant injury to the user.
2. A critical component in any component of a life support device or system whose failure to perform can be reasonably expected to cause the failure of the life support device or system, or to affect its safety or effectiveness.

Fairchild Semiconductor Corporation
 Americas
 Customer Response Center
 Tel: 1-888-522-5372

Fairchild Semiconductor Europe
 Fax: +49 (0) 1 80-530 85 86
 Email: europe.support@nsc.com
 Deutsch Tel: +49 (0) 8 141-35-0
 English Tel: +44 (0) 1 793-85-68-56
 Italy Tel: +39 (0) 2 57 5631

Fairchild Semiconductor Hong Kong Ltd.
 13th Floor, Straight Block,
 Ocean Centre, 5 Canton Rd.
 Tsimshatsui, Kowloon
 Hong Kong
 Tel: +852 2737-7200
 Fax: +852 2314-0061

National Semiconductor Japan Ltd.
 Tel: 81-3-5620-6175
 Fax: 81-3-5620-6179

www.fairchildsemi.com