

## NC7SZ05 TinyLogic™ UHS Inverter (Open Drain Output)

### General Description

The NC7SZ05 is a single Inverter with open drain output stage from Fairchild's Ultra High Speed Series of TinyLogic™. The device is fabricated with advanced CMOS technology to achieve ultra high speed with high output drive while maintaining low static power dissipation over a very broad V<sub>CC</sub> operating range. The device is specified to operate over the 1.8V to 5.5V V<sub>CC</sub> range. The input and output are high impedance when V<sub>CC</sub> is 0V. Inputs tolerate voltages up to 6V independent of V<sub>CC</sub> operating voltage. The open drain output stage tolerates voltages up to 6V independent of V<sub>CC</sub> when in the high impedance state.

### Features

- Space saving SOT23 or SC70 5-lead surface mount package
- Open drain output for OR tied applications
- Ultra High Speed; T<sub>PD</sub> 1.9 ns Typ into 50 pF at 5V V<sub>CC</sub>
- High Output I<sub>OL</sub> Drive; +24 mA at 3V V<sub>CC</sub>
- Broad V<sub>CC</sub> Operating Range; 1.8V to 5.5V
- Matches the performance of LCX when operated at 3.3V V<sub>CC</sub>
- Power down high impedance inputs/output
- Overvoltage Tolerant inputs facilitate 5V to 3V translation
- Patented noise/EMI reduction circuitry implemented

### Ordering Code:

Product Code	Package	Package Drawing	Package Top Mark	Supplied As
NC7SZ05M5	SOT23-5	MA05B	7Z05	250 Units on Tape and Reel
NC7SZ05M5X	SOT23-5	MA05B	7Z05	3k Units on Tape and Reel
NC7SZ05P5	SC70-5	MAA05A	Z05	250 Units on Tape and Reel
NC7SZ05P5X	SC70-5	MAA05A	Z05	3k Units on Tape and Reel

### Logic Symbol

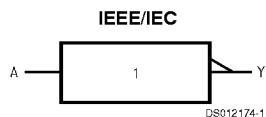

### Pin Descriptions

Pin Names	Description
A	Input
Y	Output
NC	No Connect

### Connection Diagram

Pin Assignment for 5-lead Packages

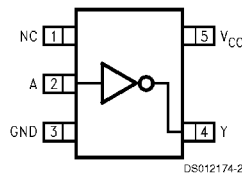

(Top View)

### Function Table

$$Y = \bar{A}$$

Input	Output
A	Y
L	*H
H	L

H = HIGH Logic Level  
L = LOW Logic Level  
\*H = HIGH Impedance output state (Open Drain)

## Absolute Maximum Ratings (Note 1)

Supply Voltage ( $V_{CC}$ )	-0.5V to +6V
DC Input Voltage ( $V_{IN}$ )	-0.5V to +6V
DC Output Voltage ( $V_{OUT}$ )	-0.5V to +6V
DC Input Diode Current ( $I_{IK}$ )	
@ $V_{IN} < -0.5V$	-50 mA
@ $V_{IN} > 6V$	+20 mA
DC Output Diode Current ( $I_{OK}$ )	
@ $V_{OUT} < -0.5V$	-50 mA
@ $V_{OUT} > 6V, V_{CC} = GND$	+20 mA
DC Output Current ( $I_{OUT}$ )	+50 mA
DC $V_{CC}/GND$ Current ( $I_{CC}/I_{GND}$ )	$\pm 50$ mA
Storage Temperature ( $T_{STG}$ )	-65°C to +150°C
Junction Temperature under Bias ( $T_J$ )	150°C
Junction Lead Temperature ( $T_1$ ); (Soldering, 10 sec)	260°C
Power Dissipation ( $P_D$ ) @ +85°C	
SOT23-5	200 mW
SC70-5	150 mW
ESD Tolerance (Human Body Model)	
MIL-STD-883D Method 3015.7	1000V
DC Latchup Tolerance (JEDEC Method 17)	

Negative Source Current (NIT)	-500 mA
Positive Source Voltage (PVT)	+8V

## Recommended Operating Conditions

Supply Voltage Operating ( $V_{CC}$ )	1.8V to 5.5V
Supply Voltage Data Retention ( $V_{CC}$ )	1.5V to 5.5V
Input Voltage ( $V_{IN}$ )	0V to 5.5V
Output Voltage ( $V_{OUT}$ )	0V to $V_{CC}$
Operating Temperature ( $T_A$ )	-40°C to +85°C
Input Rise and Fall Time ( $t_r, t_f$ )	
$V_{CC} = 1.8V, 2.5V \pm 0.2V$	0 ns/V to 20 ns/V
$V_{CC} = 3.3V \pm 0.3V$	0 ns/V to 10 ns/V
$V_{CC} = 5.0V \pm 0.5V$	0 ns/V to 5 ns/V
Thermal Resistance ( $\theta_{JA}$ )	
SOT23-5	300°C/W
SC70-5	425°C/W

**Note 1:** Absolute maximum ratings are DC values beyond which the device may be damaged or have its useful life impaired. The datasheet specification should be met, without exception, to ensure that the system design is reliable over its power supply, temperature, and output/input loading variables. Fairchild does not recommend operation outside datasheet specifications.

## DC Electrical Characteristics

Symbol	Parameter	$V_{CC}$ (V)	NC7SZ05			NC7SZ05		Unit	Conditions
			$T_A = +25^\circ\text{C}$			$T_A = -40^\circ\text{C}$ to +85°C			
			Min	Typ	Max	Min	Max		
$V_{IH}$	High Level Input Voltage	1.8 2.3-5.5	0.75 $V_{CC}$ 0.7 $V_{CC}$			0.75 $V_{CC}$ 0.7 $V_{CC}$	V		
$V_{IL}$	Low Level Input Voltage	1.8 2.3-5.5		0.25 $V_{CC}$ 0.3 $V_{CC}$		0.25 $V_{CC}$ 0.3 $V_{CC}$	V		
$I_{LKG}$	High Level Output Leakage Current	1.8-5.5		$\pm 5$		$\pm 10$	$\mu\text{A}$	$V_{IN} = V_{IL}$ $V_{OUT} = V_{CC}$ or GND	
$V_{OL}$	Low Level Output Voltage	1.8		0.0	0.1	0.1	V	$V_{IN} = V_{IH}$	$I_{OL} = 100 \mu\text{A}$
		2.3		0.0	0.1	0.1			
		3.0		0.0	0.1	0.1			
		4.5		0.0	0.1	0.1			
		2.3		0.10	0.3	0.3	V		$I_{OL} = 8 \text{ mA}$ $I_{OL} = 16 \text{ mA}$ $I_{OL} = 24 \text{ mA}$ $I_{OL} = 32 \text{ mA}$
		3.0		0.15	0.4	0.4			
3.0		0.22	0.55	0.55					
4.5		0.22	0.55	0.55					
$I_{IN}$	Input Leakage Current	0-5.5		$\pm 1$		$\pm 10$	$\mu\text{A}$	$0 \leq V_{IN} \leq 5.5V$	
$I_{OFF}$	Power Off Leakage Current	0.0		1		10	$\mu\text{A}$	$V_{IN}$ or $V_{OUT} = 5.5V$	
$I_{CC}$	Quiescent Supply Current	1.8-5.5		2.0		20	$\mu\text{A}$	$V_{IN} = 5.5V, GND$	

## AC Electrical Characteristics

Symbol	Parameter	V <sub>CC</sub> (V)	NC7SZ05			NC7SZ05		Units	Conditions	Fig. No.
			T <sub>A</sub> = +25° C			T <sub>A</sub> = 40° C to +85° C				
			Min	Typ	Max	Min	Max			
t <sub>pZL</sub>	Propagation Delay	1.8	1.5	4.6	10.5	1.5	11.0	ns	C <sub>L</sub> = 50 pF R <sub>U</sub> = 500Ω R <sub>D</sub> = 500Ω V <sub>I</sub> = 2 x V <sub>CC</sub>	Figures 1, 3
		2.5 ±0.2	0.8	3.0	7.0	0.8	7.5			
		3.3 ±0.3	0.8	2.4	5.0	0.8	5.2			
		5.0 ±0.5	0.5	1.9	4.3	0.5	4.5			
t <sub>pLZ</sub>	Propagation Delay	1.8	1.5	4.1	10.5	1.5	11.0	ns	C <sub>L</sub> = 50 pF R <sub>U</sub> = 500Ω R <sub>D</sub> = 500Ω V <sub>I</sub> = 2 x V <sub>CC</sub>	Figures 1, 3
		2.5 ±0.2	0.8	2.5	7.0	0.8	7.5			
		3.3 ±0.3	0.8	2.1	5.0	0.8	5.2			
		5.0 ±0.5	0.5	1.2	4.3	0.5	4.5			
C <sub>IN</sub>	Input Capacitance	0	4					pF		
C <sub>OUT</sub>	Output Capacitance	0	6					pF		
C <sub>PD</sub>	Power Dissipation	3.3	3.6					pF	(Note 2)	Figure 2
	Capacitance	5.0	6.5							

**Note 2:** C<sub>PD</sub> is defined as the value of the internal equivalent capacitance which is derived from dynamic operating current consumption (I<sub>CCD</sub>) at no output loading and operating at 50% duty cycle. (See Figure 2.) C<sub>PD</sub> is related to I<sub>CCD</sub> dynamic operating current by the expression: I<sub>CCD</sub> = (C<sub>PD</sub>) (V<sub>CC</sub>) (f<sub>IN</sub>) + (I<sub>CC</sub> static)

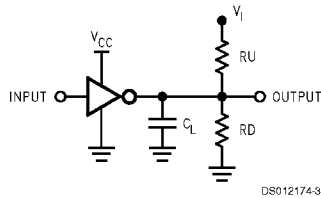

C<sub>L</sub> includes load and stray capacitance  
Input PRR = 1.0 MHz; t<sub>w</sub> = 500 ns

**FIGURE 1. AC Test Circuit**

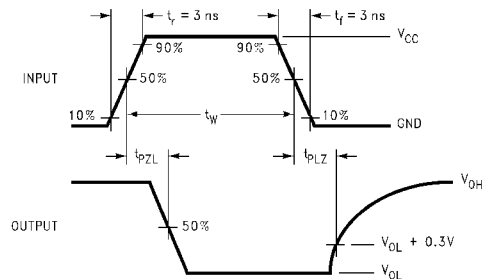

**FIGURE 3. AC Waveforms**

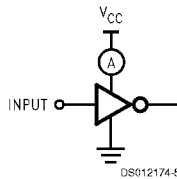

Input = AC Waveform; t<sub>r</sub> = t<sub>f</sub> = 1.8 ns  
PRR = 10 MHz; Duty Cycle = 50%

**FIGURE 2. AC Test Circuit**

## Ordering Information

The device number is used to form part of a simplified purchasing code where the package type and temperature range are defined as follows:

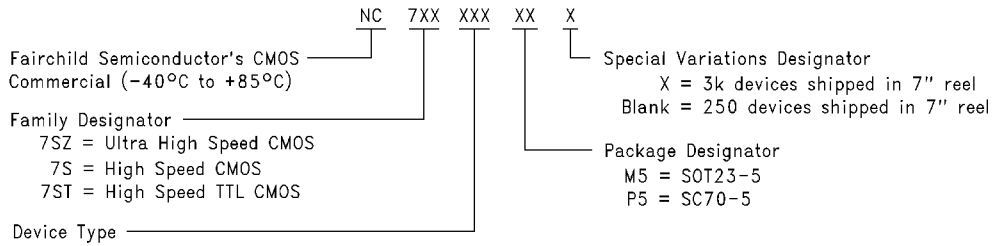

DS012174-6

# Tape and Reel Specification

## TAPE FORMAT

Package Designator	Tape Section	Number Cavities	Cavity Status	Cover Tape Status
M5, P5	Leader (Start End)	125 (typ)	Empty	Sealed
	Carrier	250	Filled	Sealed
	Trailer (Hub End)	75 (typ)	Empty	Sealed
M5X, P5X	Leader (Start End)	125 (typ)	Empty	Sealed
	Carrier	3000	Filled	Sealed
	Trailer (Hub End)	75 (typ)	Empty	Sealed

## TAPE DIMENSIONS inches (millimeters)

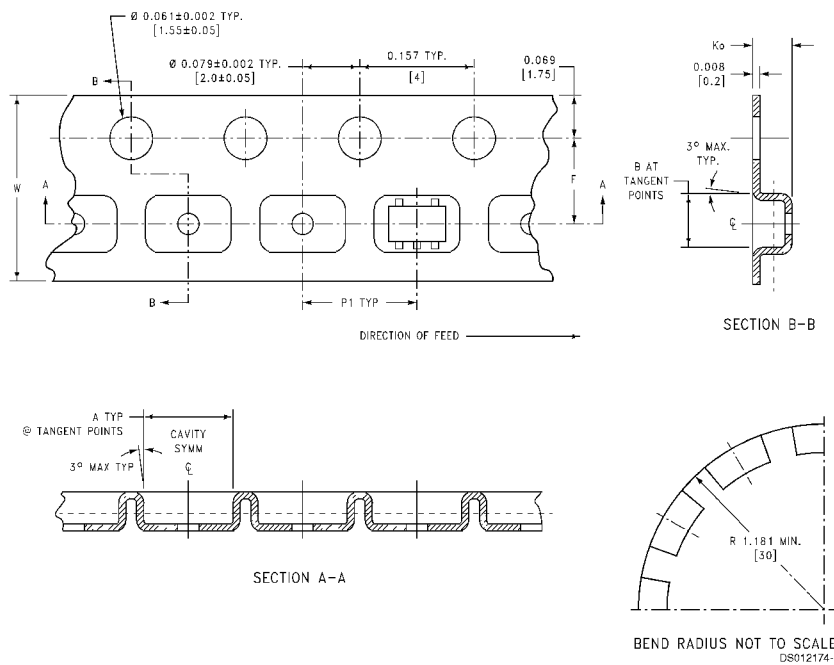

Pkg	Tape Size	DIM A	DIM B	DIM F	DIM $K_0$	DIM P1	DIM W
SC70-5	8 mm	0.093 (2.35)	0.096 (2.45)	0.138 ± 0.004 (3.5 ± 0.10)	0.053 ± 0.004 (1.35 ± 0.10)	0.157 (4)	0.315 ± 0.004 (8 ± 0.1)
SOT23-5	8 mm	0.130 (3.3)	0.130 (3.3)	0.138 ± 0.002 (3.5 ± 0.05)	0.055 ± 0.004 (1.4 ± 0.11)	0.157 (4)	0.315 ± 0.012 (8 ± 0.3)

## Tape and Reel Specification

(Continued)

REEL DIMENSIONS inches (millimeters)

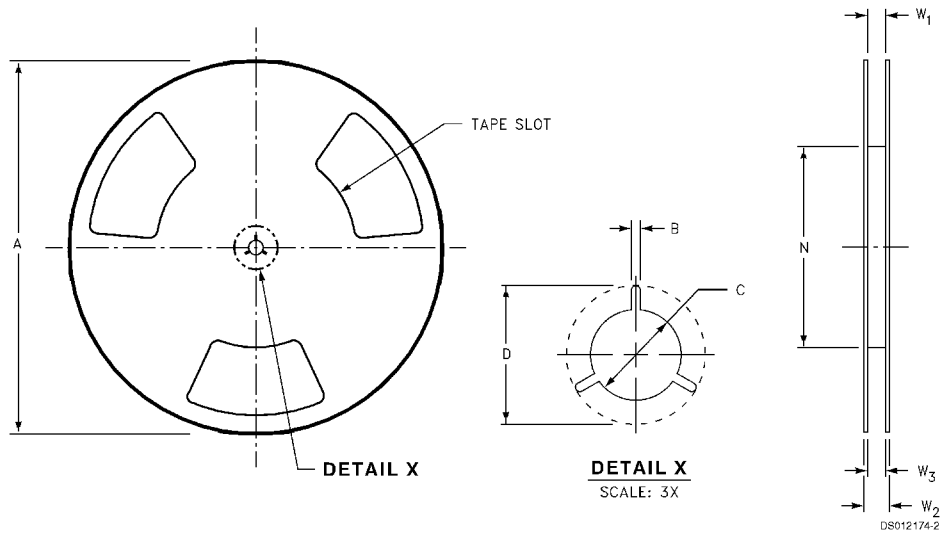

Tape Size	A	B	C	D	N	W1	W2	W3
8 mm	7.0 (177.8)	0.059 (1.50)	0.512 (13.00)	0.795 (20.20)	2.165 (55.00)	0.331 +0.059/-0.000 (8.40 +1.50/-0.00)	0.567 (14.40)	W1 +0.078/-0.039 (W1 +2.00/-1.00)

**Physical Dimensions** inches (millimeters) unless otherwise noted

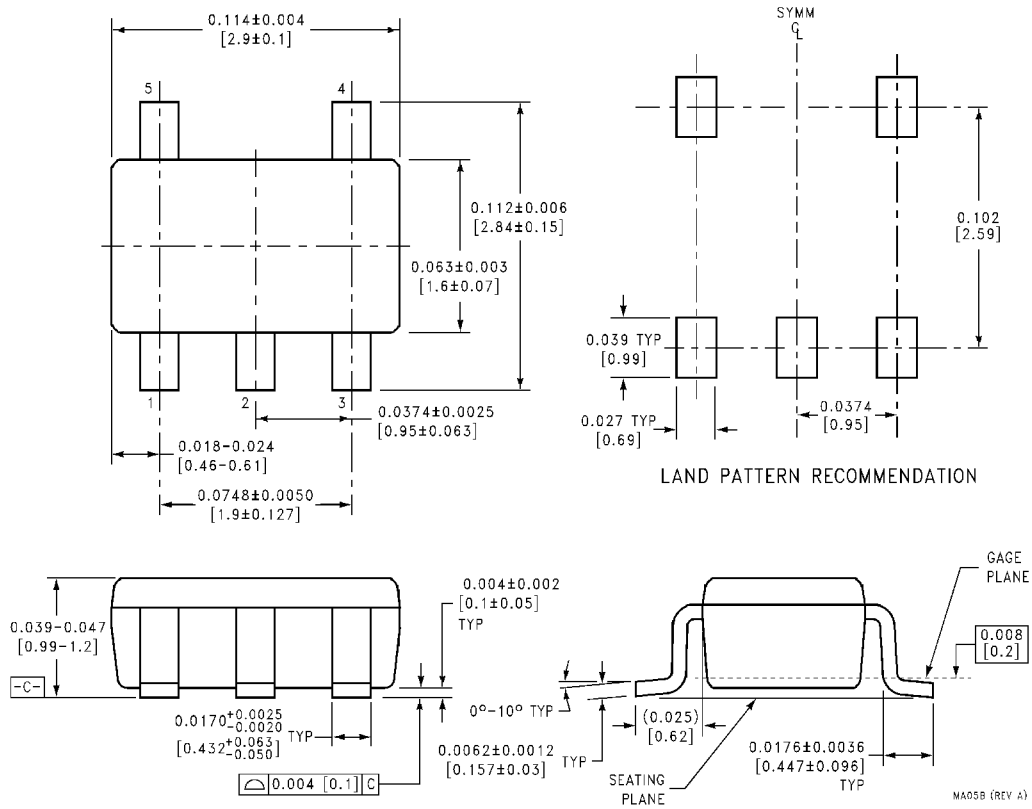

**5-Lead Molded SOT23 Enhanced Thermal Package Number MA05B**

**Physical Dimensions** inches (millimeters) unless otherwise noted (Continued)

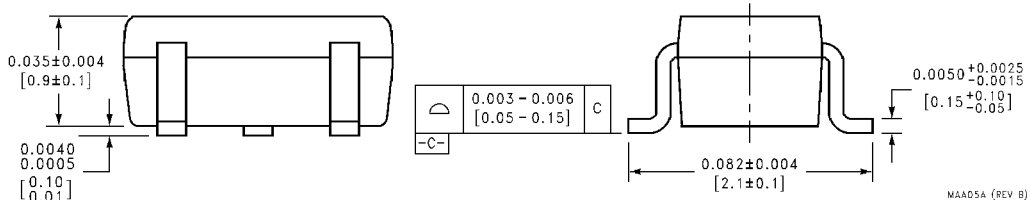
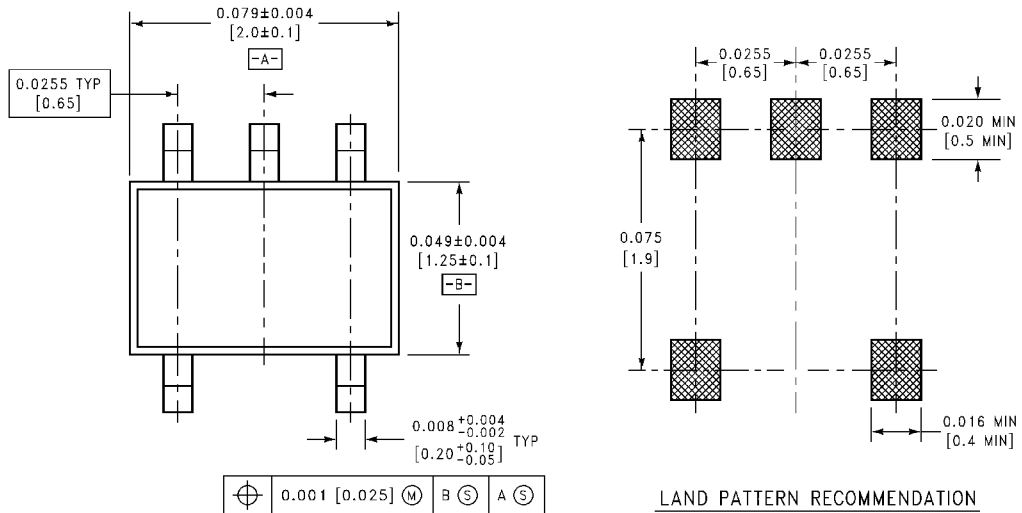

**5-Lead Molded SC70, Enhanced Thermal Package Number MAA05A**

MAA05A (REV B)

**LIFE SUPPORT POLICY**

FAIRCHILD'S PRODUCTS ARE NOT AUTHORIZED FOR USE AS CRITICAL COMPONENTS IN LIFE SUPPORT DEVICES OR SYSTEMS WITHOUT THE EXPRESS WRITTEN APPROVAL OF THE PRESIDENT OF FAIRCHILD SEMICONDUCTOR CORPORATION. As used herein:

1. Life support devices or systems are devices or systems which, (a) are intended for surgical implant into the body, or (b) support or sustain life, and (c) whose failure to perform when properly used in accordance with instructions for use provided in the labeling, can be reasonably expected to result in a significant injury to the user.
2. A critical component in any component of a life support device or system whose failure to perform can be reasonably expected to cause the failure of the life support device or system, or to affect its safety or effectiveness.

**Fairchild Semiconductor Corporation Americas**  
Customer Response Center  
Tel: 1-888-522-5372

**Fairchild Semiconductor Europe**  
Fax: +49 (0) 1 80-530 85 86  
Email: europe.support@nsc.com  
Deutsch Tel: +49 (0) 8 141-35-0  
English Tel: +44 (0) 1 793-85-68-56  
Italy Tel: +39 (0) 2 57 5631

**Fairchild Semiconductor Hong Kong Ltd.**  
13th Floor, Straight Block,  
Ocean Centre, 5 Canton Rd.  
Tsimshatsui, Kowloon  
Hong Kong  
Tel: +852 2737-7200  
Fax: +852 2314-0061

**National Semiconductor Japan Ltd.**  
Tel: 81-3-5620-6175  
Fax: 81-3-5620-6179

[www.fairchildsemi.com](http://www.fairchildsemi.com)