

DM74LS09

Quad 2-Input AND Gates with Open-Collector Outputs

General Description

This device contains four independent gates each of which performs the logic AND function. The open-collector outputs require external pull-up resistors for proper logical operation.

Features

- Alternate Military/Aerospace device (54LS09) is available. Contact a Fairchild Semiconductor Sales Office/Distributor for specifications.

Pull-Up Resistor Equations

$$R_{MAX} = \frac{V_{CC} (Min) - V_{OH}}{N_1 (I_{OH}) + N_2 (I_{IH})}$$

$$R_{MIN} = \frac{V_{CC} (Max) - V_{OL}}{I_{OL} - N_3 (I_{IL})}$$

Where: $N_1 (I_{OH})$ = total maximum output high current for all outputs tied to pull-up resistor
 $N_2 (I_{IH})$ = total maximum input high current for all inputs tied to pull-up resistor
 $N_3 (I_{IL})$ = total maximum input low current for all inputs tied to pull-up resistor

Connection Diagram

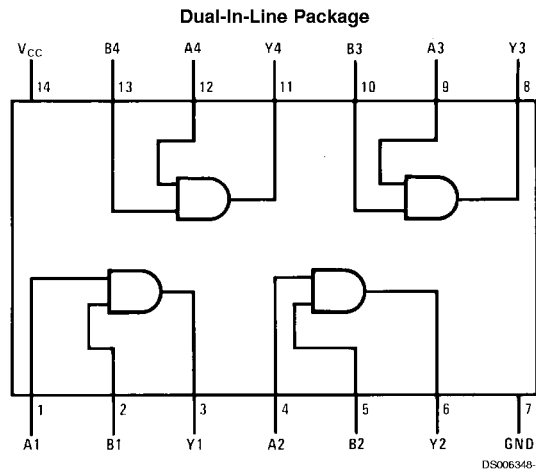

Order Number 54LS09DMQB, 54LS09FMQB, DM54LS09J, DM54LS09W, DM74LS09M or DM74LS09N
 See Package Number E20A, J14A, M14A, N14A or W14B

Function Table

Y = AB

Inputs		Output
A	B	Y
L	L	L
L	H	L
H	L	L
H	H	H

H = High Logic Level
 L = Low Logic Level

DM74LS09 Quad 2-Input AND Gates with Open-Collector Outputs

Absolute Maximum Ratings (Note 1)

Supply Voltage	7V	Operating Free Air Temperature Range	DM54LS and 54LS	-55°C to +125°C
Input Voltage	7V		DM74LS	0°C to +70°C
Output Voltage	7V	Storage Temperature Range		-65°C to +150°C

Recommended Operating Conditions

Symbol	Parameter	DM54LS09			DM74LS09			Units
		Min	Nom	Max	Min	Nom	Max	
V _{CC}	Supply Voltage	4.5	5	5.5	4.75	5	5.25	V
V _{IH}	High Level Input Voltage	2			2			V
V _{IL}	Low Level Input Voltage			0.7			0.8	V
V _{OH}	High Level Output Voltage			5.5			5.5	V
I _{OL}	Low Level Output Current			4			8	mA
T _A	Free Air Operating Temperature	-55		125	0		70	°C

Note 1: The "Absolute Maximum Ratings" are those values beyond which the safety of the device cannot be guaranteed. The device should not be operated at these limits. The parametric values defined in the "Electrical Characteristics" table are not guaranteed at the absolute maximum ratings. The "Recommended Operating Conditions" table will define the conditions for actual device operation.

Electrical Characteristics

over recommended operating free air temperature range (unless otherwise noted)

Symbol	Parameter	Conditions	Min	Typ (Note 2)	Max	Units
V _I	Input Clamp Voltage	V _{CC} = Min, I _I = -18 mA			-1.5	V
I _{CEX}	High Level Output Current	V _{CC} = Min, V _O = 5.5V V _{IH} = Min			100	μA
V _{OL}	Low Level Output Voltage	V _{CC} = Min, I _{OL} = Max	DM54	0.25	0.4	V
		V _{IL} = Max	DM74	0.35	0.5	
		I _{OL} = 4 mA, V _{CC} = Min	DM74	0.25	0.4	
I _I	Input Current @Max Input Voltage	V _{CC} = Max, V _I = 7V			0.1	mA
I _{IH}	High Level Input Current	V _{CC} = Max, V _I = 2.7V			20	μA
I _{IL}	Low Level Input Current	V _{CC} = Max, V _I = 0.4V			-0.36	mA
I _{CCH}	Supply Current With Outputs High	V _{CC} = Max		2.4	4.8	mA
I _{CCL}	Supply Current With Outputs Low	V _{CC} = Max		4.4	8.8	mA

Switching Characteristics

at V_{CC} = 5V and T_A = 25°C

Symbol	Parameter	R _L = 2 kΩ				Units
		C _L = 15 pF		C _L = 50 pF		
		Min	Max	Min	Max	
t _{PLH}	Propagation Delay Time Low to High Level Output	5	20	8	45	ns
t _{PHL}	Propagation Delay Time High to Low Level Output	4	15	6	27	ns

Note 2: All typicals are at V_{CC} = 5V, T_A = 25°C.

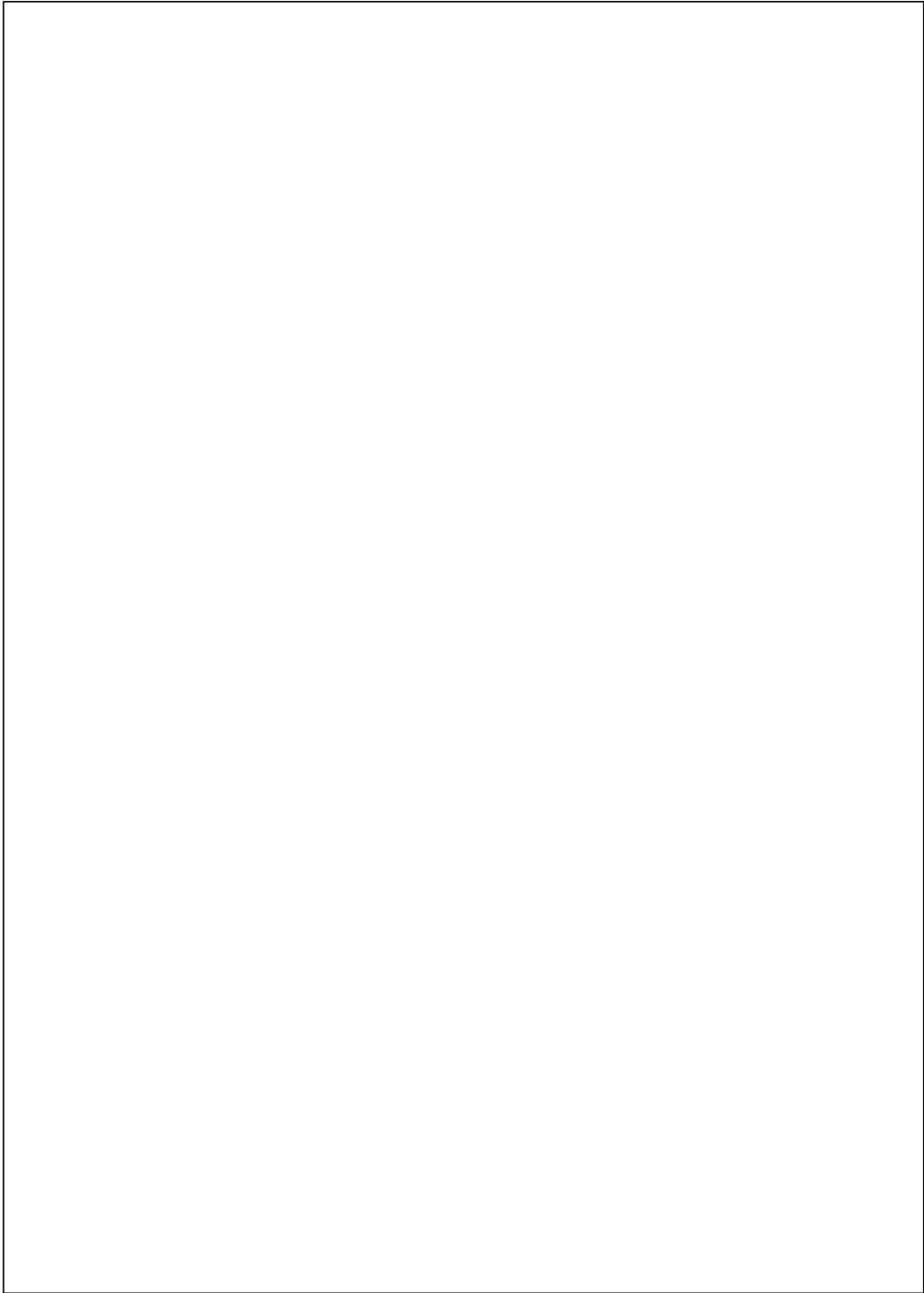

Physical Dimensions inches (millimeters) unless otherwise noted

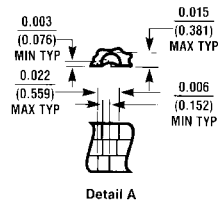
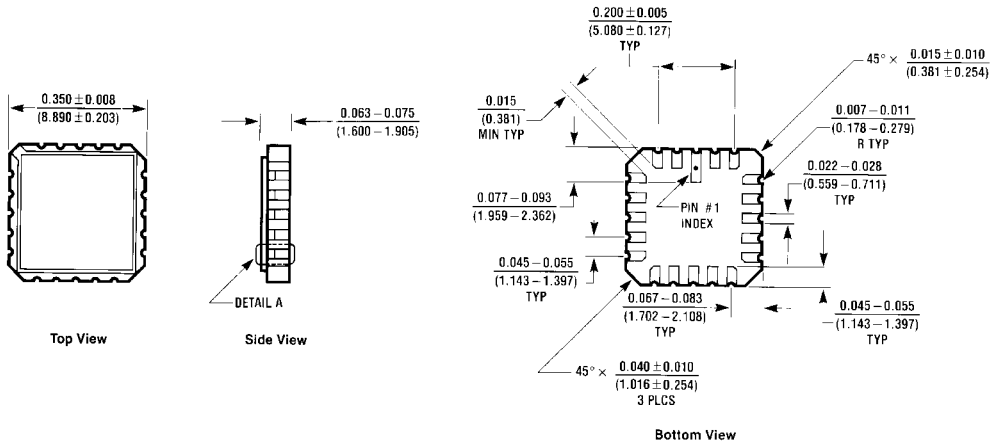

Ceramic Leadless Chip Carrier Package (E)
 Order Number 54LS09LMQB
 Package Number E20A

L204 (REV D)

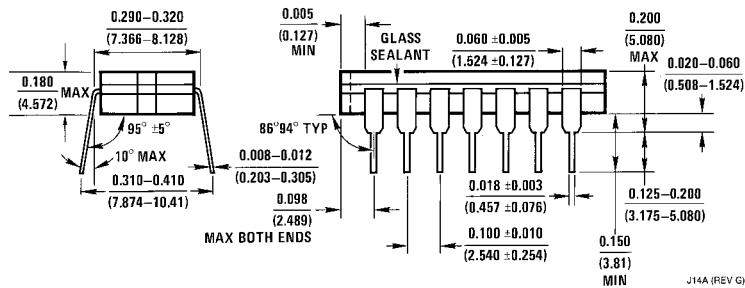
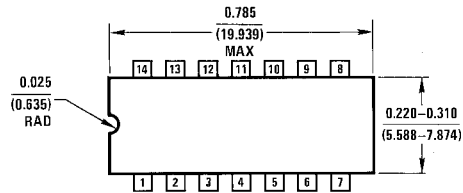

14-Lead Ceramic Dual-In-Line Package (J)
 Order Number 54LS09DMQB or DM54LS09J
 Package Number J14A

J14A (REV G)

Physical Dimensions inches (millimeters) unless otherwise noted (Continued)

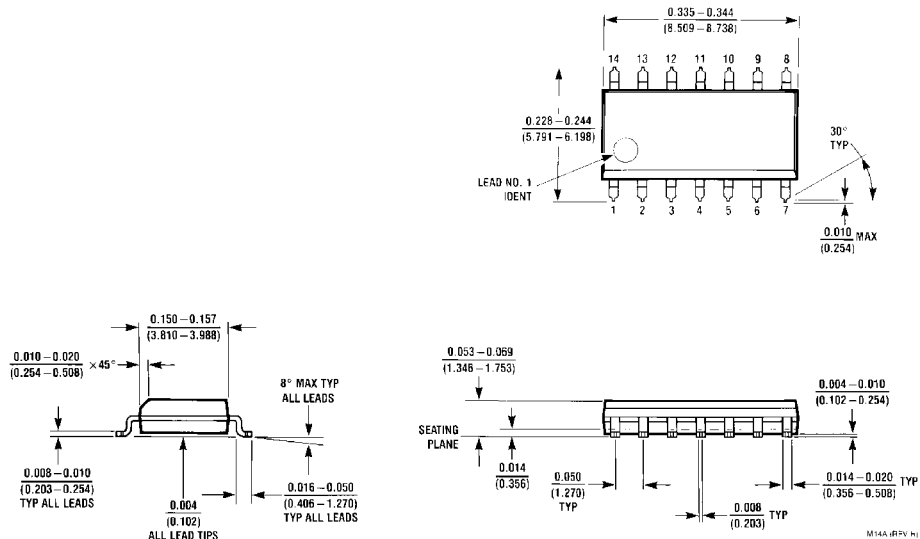

14-Lead Small Outline Molded Package (M)
Order Number DM74LS09M
Package Number M14A

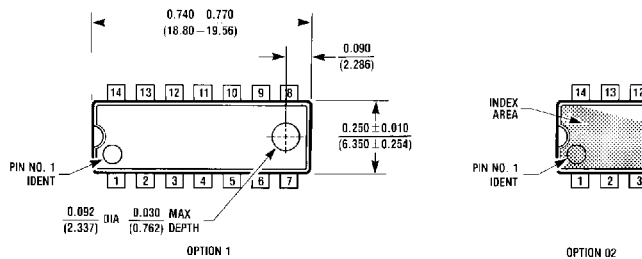

14-Lead Molded Dual-In-Line Package (N)
Order Number DM74LS09N
Package Number N14A

Physical Dimensions inches (millimeters) unless otherwise noted (Continued)

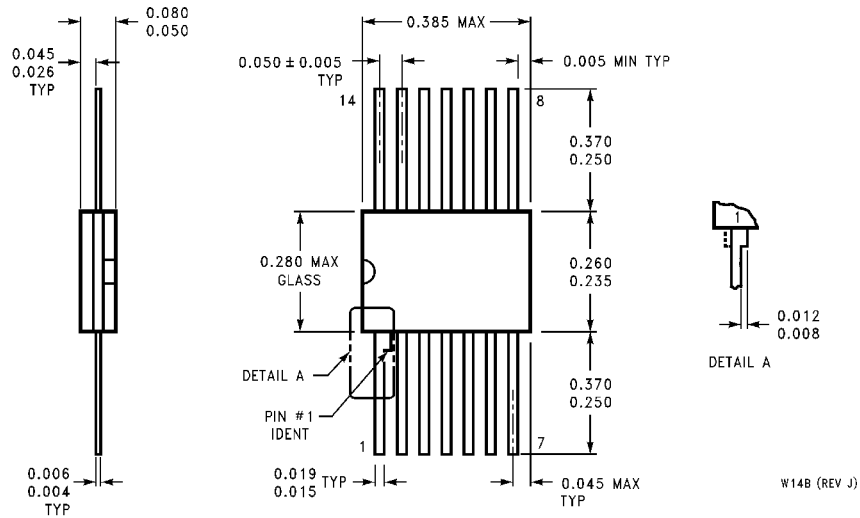

14-Lead Ceramic Flat Package (W)
Order Number 54LS09FMQB or DM54LS09W
Package Number W14B

LIFE SUPPORT POLICY

FAIRCHILD'S PRODUCTS ARE NOT AUTHORIZED FOR USE AS CRITICAL COMPONENTS IN LIFE SUPPORT DEVICES OR SYSTEMS WITHOUT THE EXPRESS WRITTEN APPROVAL OF THE PRESIDENT OF FAIRCHILD SEMICONDUCTOR CORPORATION. As used herein:

1. Life support devices or systems are devices or systems which, (a) are intended for surgical implant into the body, or (b) support or sustain life, and (c) whose failure to perform when properly used in accordance with instructions for use provided in the labeling can be reasonably expected to result in a significant injury to the user.
2. A critical component in any component of a life support device or system whose failure to perform can be reasonably expected to cause the failure of the life support device or system, or to affect its safety or effectiveness.

Fairchild Semiconductor Corporation
 Americas
 Customer Response Center
 Tel: 1-888-522-5372

Fairchild Semiconductor Europe
 Fax: +49 (0) 1 80-530 85 86
 Email: europe.support@nsc.com
 Deutsch Tel: +49 (0) 8 141-35-0
 English Tel: +44 (0) 1 793-85-68-56
 Italy Tel: +39 (0) 2 57 5631

Fairchild Semiconductor Hong Kong Ltd.
 13th Floor, Straight Block,
 Ocean Centre, 5 Canton Rd.
 Tsimshatsui, Kowloon
 Hong Kong
 Tel: +852 2737-7200
 Fax: +852 2314-0061

National Semiconductor Japan Ltd.
 Tel: 81-3-5620-6175
 Fax: 81-3-5620-6179

www.fairchildsemi.com