

## NC7SV14 TinyLogic® ULP-A Inverter with Schmitt Trigger Input

### General Description

The NC7SV14 is a single inverter with Schmitt trigger from Fairchild's Ultra Low Power-A (ULP-A) Series of TinyLogic®. ULP-A is ideal for applications that require extreme high speed, high drive and low power. This product is designed for a wide low voltage operating range (0.9V to 3.6V  $V_{CC}$ ) and applications that require more drive and speed than the TinyLogic ULP series, but still offer best in class low power operation.

The NC7SV14 is uniquely designed for optimized power and speed, and is fabricated with an advanced CMOS technology to achieve high-speed operation while maintaining low CMOS power dissipation.

### Features

- 0.9V to 3.6V  $V_{CC}$  supply operation
- 3.6V overvoltage tolerant I/O's at  $V_{CC}$  from 0.9V to 3.6V
- Extremely High Speed  $t_{PD}$ 
  - 1.5 ns typ for 2.7V to 3.6V  $V_{CC}$
  - 1.8 ns typ for 2.3V to 2.7V  $V_{CC}$
  - 2.0 ns typ for 1.65V to 1.95V  $V_{CC}$
  - 3.2 ns typ for 1.4V to 1.6V  $V_{CC}$
  - 5.9 ns typ for 1.1V to 1.3V  $V_{CC}$
  - 12.0 ns typ for 0.9V  $V_{CC}$
- Power-Off high impedance inputs and outputs
- High Static Drive ( $I_{OH}/I_{OL}$ )
  - ±24 mA @ 3.00V  $V_{CC}$
  - ±18 mA @ 2.30V  $V_{CC}$
  - ±6 mA @ 1.65V  $V_{CC}$
  - ±4 mA @ 1.4V  $V_{CC}$
  - ±2 mA @ 1.1V  $V_{CC}$
  - ±0.1 mA @ 0.9V  $V_{CC}$
- Uses patented Quiet Series™ noise/EMI reduction circuitry
- Ultra small MicroPak™ leadfree package
- Ultra low dynamic power

### Ordering Code:

Order Number	Package Number	Product Code Top Mark	Package Description	Supplied As
NC7SV14P5X	MAA05A	V14	5-Lead SC70, EIAJ SC-88a, 1.25mm Wide	3k Units on Tape and Reel
NC7SV14L6X	MAC06A	G4	6-Lead MicroPak, 1.0mm Wide	5k Units on Tape and Reel

### Battery Life vs. $V_{CC}$ Supply Voltage

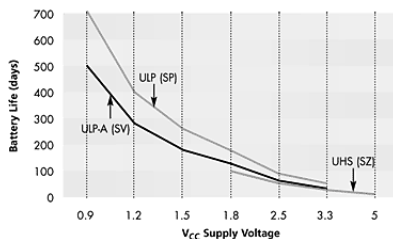

TinyLogic ULP and ULP-A with up to 50% less power consumption can extend your battery life significantly.

$$\text{Battery Life} = (V_{\text{battery}} \cdot I_{\text{battery}} \cdot 9) / (P_{\text{device}}) / 24 \text{hrs/day}$$

$$\text{Where, } P_{\text{device}} = (I_{CC} \cdot V_{CC}) + (C_{PD} + C_L) \cdot V_{CC}^2 \cdot f$$

Assumes ideal 3.6V Lithium Ion battery with current rating of 900mAh and derated 90% and device frequency at 10MHz, with  $C_L = 15 \text{ pF}$  load

TinyLogic® is a registered trademark of Fairchild Semiconductor Corporation.  
MicroPak™, and Quiet Series™ are trademarks of Fairchild Semiconductor Corporation.

**Logic Symbol**

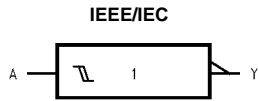

**Pin Descriptions**

Pin Names	Description
A	Input
Y	Output
NC	No Connect

**Function Table**

$$Y = \bar{A}$$

Input	Output
A	Y
L	H
H	L

H = HIGH Logic Level  
L = LOW Logic Level

**Connection Diagrams**

**Pin Assignments for SC70**

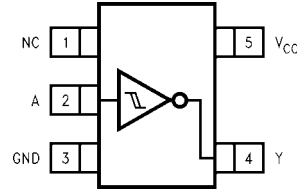

(Top View)

**Pad Assignments for MicroPak**

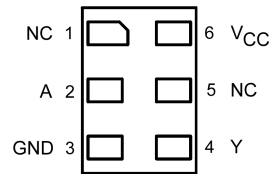

(Top Thru View)

<b>Absolute Maximum Ratings</b> (Note 1)			<b>Recommended Operating Conditions</b> (Note 3)					
Supply Voltage ( $V_{CC}$ )	-0.5V to +4.6V		Supply Voltage	0.9V to 3.6V				
DC Input Voltage ( $V_{IN}$ )	-0.5V to +4.6V		Input Voltage ( $V_{IN}$ )	0V to 3.6V				
DC Output Voltage ( $V_{OUT}$ )			Output Voltage ( $V_{OUT}$ )	0V to 3.6V				
HIGH or LOW State (Note 2)	-0.5V to $V_{CC}$ +0.5V		$V_{CC} = 0.0V$	0V to 3.6V				
$V_{CC} = 0V$	-0.5V to +4.6V		HIGH or LOW State	0V to $V_{CC}$				
DC Input Diode Current ( $I_{IK}$ ) $V_{IN} < 0V$	±50 mA		Output Current in $I_{OH}/I_{OL}$					
DC Output Diode Current ( $I_{OK}$ )			$V_{CC} = 3.0V$ to 3.6V	±24 mA				
$V_{OUT} < 0V$	-50 mA		$V_{CC} = 2.3V$ to 2.7V	±18 mA				
$V_{OUT} > V_{CC}$	+50 mA		$V_{CC} = 1.65V$ to 1.95V	±6 mA				
DC Output Source/Sink Current ( $I_{OH}/I_{OL}$ )	± 50 mA		$V_{CC} = 1.4V$ to 1.6V	±4 mA				
DC $V_{CC}$ or Ground Current per			$V_{CC} = 1.1V$ to 1.3V	±2 mA				
Supply Pin ( $I_{CC}$ or Ground)	± 50 mA		$V_{CC} = 0.9V$	±0.1 mA				
Storage Temperature Range ( $T_{STG}$ )	-65°C to +150°C		Free Air Operating Temperature ( $T_A$ )	-40°C to +85°C				
			Minimum Input Edge Rate ( $\Delta t/\Delta V$ )					
			$V_{IN} = 0.8V$ to 2.0V, $V_{CC} = 3.0V$	10 ns/V				
			<p><b>Note 1:</b> Absolute Maximum Ratings: are those values beyond which the safety of the device cannot be guaranteed. The device should not be operated at these limits. The parametric values defined in the Electrical Characteristics tables are not guaranteed at the absolute maximum ratings. The "Recommended Operating Conditions" table will define the conditions for actual device operation.</p> <p><b>Note 2:</b> <math>I_O</math> Absolute Maximum Rating must be observed.</p> <p><b>Note 3:</b> Unused inputs must be held HIGH or LOW. They may not float.</p>					
<b>DC Electrical Characteristics</b>								
Symbol	Parameter	$V_{CC}$ (V)	$T_A = +25^\circ C$		$T_A = -40^\circ C$ to $+85^\circ C$		Units	Conditions
			Min	Max	Min	Max		
$V_P$	Positive Threshold Voltage	0.90	0.3	0.7	0.3	0.7	V	
		1.10	0.4	1.0	0.4	1.0		
		1.40	0.5	1.4	0.5	1.4		
		1.65	0.7	1.5	0.7	1.5		
		2.30	1.0	1.8	1.0	1.8		
		2.70	1.3	2.2	1.3	2.2		
$V_N$	Negative Threshold Voltage	0.90	0.10	0.6	0.10	0.6	V	
		1.10	0.15	0.7	0.15	0.7		
		1.40	0.20	0.8	0.20	0.8		
		1.65	0.25	0.9	0.25	0.9		
		2.30	0.4	1.15	0.4	1.15		
		2.70	0.6	1.5	0.6	1.5		
$V_H$	Hysteresis Voltage	0.90	0.07	0.5	0.07	0.5	V	
		1.10	0.08	0.6	0.08	0.6		
		1.40	0.10	0.8	0.10	0.8		
		1.65	0.15	1.0	0.15	1.0		
		2.30	0.25	1.1	0.25	1.1		
		2.70	0.40	1.2	0.40	1.2		

**DC Electrical Characteristics** (Continued)

Symbol	Parameter	V <sub>CC</sub> (V)	T <sub>A</sub> = +25°C		T <sub>A</sub> = -40°C to +85°C		Units	Conditions
			Min	Max	Min	Max		
V <sub>OH</sub>	HIGH Level Output Voltage	0.90	V <sub>CC</sub> - 0.1		V <sub>CC</sub> - 0.1		V	I <sub>OH</sub> = -100 μA
		1.10 ≤ V <sub>CC</sub> ≤ 1.30	V <sub>CC</sub> - 0.1		V <sub>CC</sub> - 0.1			
		1.40 ≤ V <sub>CC</sub> ≤ 1.60	V <sub>CC</sub> - 0.2		V <sub>CC</sub> - 0.2			
		1.65 ≤ V <sub>CC</sub> ≤ 1.95	V <sub>CC</sub> - 0.2		V <sub>CC</sub> - 0.2			
		2.30 ≤ V <sub>CC</sub> < 2.70	V <sub>CC</sub> - 0.2		V <sub>CC</sub> - 0.2			
		2.70 ≤ V <sub>CC</sub> ≤ 3.60	V <sub>CC</sub> - 0.2		V <sub>CC</sub> - 0.2			
		1.10 ≤ V <sub>CC</sub> ≤ 1.30	0.75 x V <sub>CC</sub>		0.75 x V <sub>CC</sub>			
		1.40 ≤ V <sub>CC</sub> ≤ 1.60	0.75 x V <sub>CC</sub>		0.75 x V <sub>CC</sub>			
		1.65 ≤ V <sub>CC</sub> ≤ 1.95	1.25		1.25			
		2.30 ≤ V <sub>CC</sub> < 2.70	2.0		2.0			
		2.30 ≤ V <sub>CC</sub> < 2.70	1.8		1.8			
		2.70 ≤ V <sub>CC</sub> ≤ 3.60	2.2		2.2			
V <sub>OL</sub>	LOW Level Output Voltage	0.90	0.1		0.1		V	I <sub>OL</sub> = 100 μA
		1.10 ≤ V <sub>CC</sub> ≤ 1.30	0.1		0.1			
		1.40 ≤ V <sub>CC</sub> ≤ 1.60	0.2		0.2			
		1.65 ≤ V <sub>CC</sub> ≤ 1.95	0.2		0.2			
		2.30 ≤ V <sub>CC</sub> < 2.70	0.2		0.2			
		2.70 ≤ V <sub>CC</sub> ≤ 3.60	0.2		0.2			
		1.10 ≤ V <sub>CC</sub> ≤ 1.30	0.25 x V <sub>CC</sub>		0.25 x V <sub>CC</sub>			
		1.40 ≤ V <sub>CC</sub> ≤ 1.60	0.25 x V <sub>CC</sub>		0.25 x V <sub>CC</sub>			
		1.65 ≤ V <sub>CC</sub> ≤ 1.95	0.3		0.3			
		2.30 ≤ V <sub>CC</sub> < 2.70	0.4		0.4			
		2.70 ≤ V <sub>CC</sub> ≤ 3.60	0.4		0.4			
		2.30 ≤ V <sub>CC</sub> < 2.70	0.6		0.6			
2.70 ≤ V <sub>CC</sub> ≤ 3.60	0.4		0.4					
2.70 ≤ V <sub>CC</sub> ≤ 3.60	0.55		0.55					
I <sub>IN</sub>	Input Leakage Current	0.90 to 3.60	±0.1		±0.5		μA	0 ≤ V <sub>I</sub> ≤ 3.6V
I <sub>OFF</sub>	Power Off Leakage Current	0	0.5		0.5		μA	0 ≤ (V <sub>I</sub> , V <sub>O</sub> ) ≤ 3.6V
I <sub>CC</sub>	Quiescent Supply Current	0.90 to 3.60	0.9		0.9		μA	V <sub>I</sub> = V <sub>CC</sub> or GND
		0.90 to 3.60			±0.9			V <sub>CC</sub> ≤ V <sub>I</sub> ≤ 3.6V

**AC Electrical Characteristics**

Symbol	Parameter	V <sub>CC</sub> (V)	T <sub>A</sub> = +25°C			T <sub>A</sub> = -40°C to +85°C		Units	Conditions	Figure Number
			Min	Typ	Max	Min	Max			
t <sub>PHL</sub> t <sub>PLH</sub>	Propagation Delay	0.90	12					ns	C <sub>L</sub> = 15 pF, R <sub>L</sub> = 1 MΩ	Figures 1, 2
		1.10 ≤ V <sub>CC</sub> ≤ 1.30	2.0	5.9	10.0	1.0	14.9		C <sub>L</sub> = 15 pF, R <sub>L</sub> = 2 kΩ	
		1.40 ≤ V <sub>CC</sub> ≤ 1.60	1.0	3.2	6.1	0.9	7.0			
		1.65 ≤ V <sub>CC</sub> ≤ 1.95	1.0	2.0	5.2	0.7	6.2		C <sub>L</sub> = 30 pF	
		2.30 ≤ V <sub>CC</sub> < 2.70	0.8	1.8	3.7	0.6	4.4		R <sub>L</sub> = 500Ω	
C <sub>IN</sub>	Input Capacitance	0	2.0					pF		
C <sub>OUT</sub>	Output Capacitance	0	4.5					pF		
C <sub>PD</sub>	Power Dissipation Capacitance	0.90 to 3.60	10					pF	V <sub>I</sub> = 0V or V <sub>CC</sub> f = 10 MHz	

## AC Loading and Waveforms

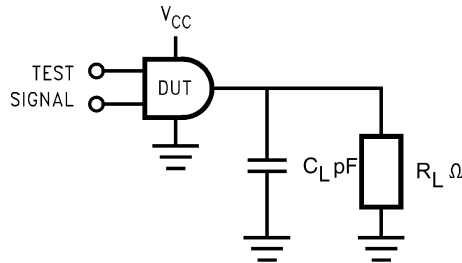

FIGURE 1. AC Test Circuit

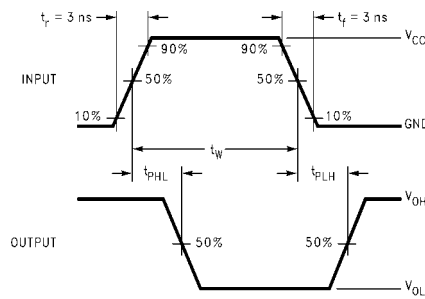

FIGURE 2. AC Waveforms

Symbol	$V_{CC}$					
	3.3V ± 0.3V	2.5V ± 0.2V	1.8V ± 0.15V	1.5V ± 0.10V	1.2V ± 0.10V	0.9V
$V_{mi}$	1.5V	$V_{CC}/2$	$V_{CC}/2$	$V_{CC}/2$	$V_{CC}/2$	$V_{CC}/2$
$V_{mo}$	1.5V	$V_{CC}/2$	$V_{CC}/2$	$V_{CC}/2$	$V_{CC}/2$	$V_{CC}/2$



**Tape and Reel Specification** (Continued)

**TAPE FORMAT for MicroPak**

Package Designator	Tape Section	Number Cavities	Cavity Status	Cover Tape Status
L6X	Leader (Start End)	125 (typ)	Empty	Sealed
	Carrier	5000	Filled	Sealed
	Trailer (Hub End)	75 (typ)	Empty	Sealed

**TAPE DIMENSIONS** inches (millimeters)



**REEL DIMENSIONS** inches (millimeters)

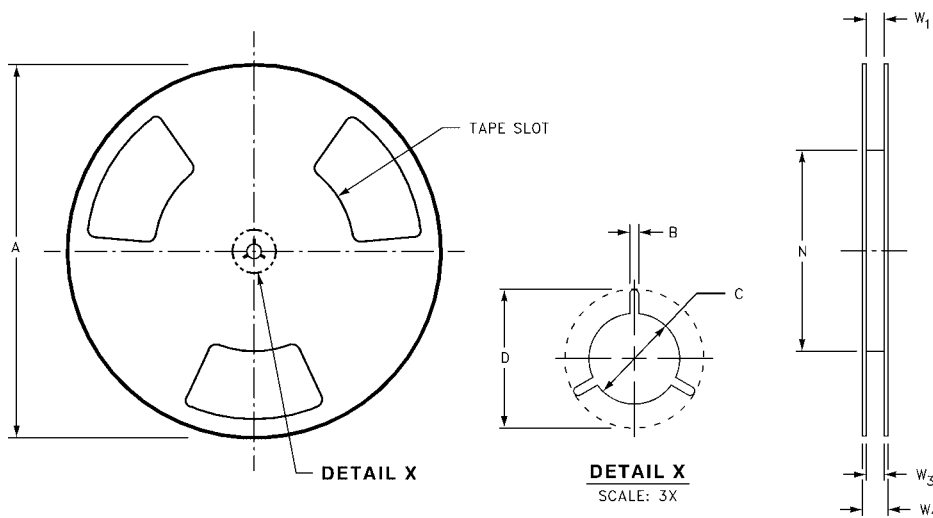

Tape Size	A	B	C	D	N	W1	W2	W3
8 mm	7.0 (177.8)	0.059 (1.50)	0.512 (13.00)	0.795 (20.20)	2.165 (55.00)	0.331 + 0.059/-0.000 (8.40 + 1.50/-0.00)	0.567 (14.40)	W1 + 0.078/-0.039 (W1 + 2.00/-1.00)

**Physical Dimensions** inches (millimeters) unless otherwise noted



NOTES:

- A. CONFORMS TO EIAJ REGISTERED OUTLINE DRAWING SC88A.
- B. DIMENSIONS DO NOT INCLUDE BURRS OR MOLD FLASH.
- C. DIMENSIONS ARE IN MILLIMETERS.

MAA05ARevC

**5-Lead SC70, EIAJ SC-88a, 1.25mm Wide  
Package Number MAA05A**



**Physical Dimensions** inches (millimeters) unless otherwise noted (Continued)



- Notes:
1. JEDEC PACKAGE REGISTRATION IS ANTICIPATED
  2. DIMENSIONS ARE IN MILLIMETERS
  3. DRAWING CONFORMS TO ASME Y14.5M-1994

MAC06ARevB

**6-Lead MicroPak, 1.0mm Wide  
Package Number MAC06A**

Fairchild does not assume any responsibility for use of any circuitry described, no circuit patent licenses are implied and Fairchild reserves the right at any time without notice to change said circuitry and specifications.

**LIFE SUPPORT POLICY**

FAIRCHILD'S PRODUCTS ARE NOT AUTHORIZED FOR USE AS CRITICAL COMPONENTS IN LIFE SUPPORT DEVICES OR SYSTEMS WITHOUT THE EXPRESS WRITTEN APPROVAL OF THE PRESIDENT OF FAIRCHILD SEMICONDUCTOR CORPORATION. As used herein:

1. Life support devices or systems are devices or systems which, (a) are intended for surgical implant into the body, or (b) support or sustain life, and (c) whose failure to perform when properly used in accordance with instructions for use provided in the labeling, can be reasonably expected to result in a significant injury to the user.
2. A critical component in any component of a life support device or system whose failure to perform can be reasonably expected to cause the failure of the life support device or system, or to affect its safety or effectiveness.

[www.fairchildsemi.com](http://www.fairchildsemi.com)