

NIMD6001N, NIMD6001AN

Dual N-Channel Driver with Diagnostic Output 60 V, 3 A, 110 mΩ

NIMD6001N/AN is a dual 3 Amp low-side switch with an integrated common disable input and drain diagnostic output. Pulling the Disable pin low will override any applied gate voltages and turn off both FET switches. Should either Drain-Source voltage exceed approximately 50 V, a logic 1 (> 3 V) will be asserted on the Diagnostic/Feedback pin. Internal isolation diodes permit the Disable and Diagnostic/ Feedback pins of multiple devices to be interconnected in a “wired-OR” configuration without additional components.

Features

- $R_{DS(on)}$ 110 mΩ Maximum at $V_{GS} = 10$ V
- Avalanche Energy Specified
- Gate Drive Disable Input
- Drain-Source Voltage Diagnostic Feedback Output
- Electrically Isolated Drains for Low Crosstalk
- Internal Resistors Limit Peak Transient gate Current
- AEC-Q101 Qualified and PPAP Capable
- These Devices are Pb-Free and are RoHS Compliant

Applications

- Automotive Injector Driver
- Solenoid / Relay Driver

MAXIMUM RATINGS ($T_J = 25^\circ\text{C}$ unless otherwise noted)

Rating	Symbol	Value	Unit
Drain-to-Source Voltage (DC, sustained)	V_{DSS}	60	Vdc
Gate-to-Source Voltage	V_{GS}	± 20	Vdc
Continuous Drain Current $V_{GS} = 10$ V, $R_{\theta JA} = 55^\circ\text{C/W}$ $V_{GS} = 5.0$ V, $R_{\theta JA} = 55^\circ\text{C/W}$	I_D	3.3 3.0	A
Single Pulse Drain Current Pulse duration = 80 μs	I_D	10	A
Single Pulse Drain-to-Source Avalanche Energy $V_{DD} = 60$ V; $V_{GS} = 10$ V; $I_{PK} = 2.6$ A; L = 76 mH; Start $T_J = 25^\circ\text{C}$	E_{AS}	258	mJ
Operating Junction Temperature	T_J	-55 – 150	$^\circ\text{C}$
Storage Temperature	T_{STG}	-55 – 150	$^\circ\text{C}$

Stresses exceeding Maximum Ratings may damage the device. Maximum Ratings are stress ratings only. Functional operation above the Recommended Operating Conditions is not implied. Extended exposure to stresses above the Recommended Operating Conditions may affect device reliability.



ON Semiconductor®

<http://onsemi.com>

3.0 AMPERES
60 VOLTS

$R_{DS(on)} = 110$ mΩ



SOIC-8
CASE 751

MARKING DIAGRAM

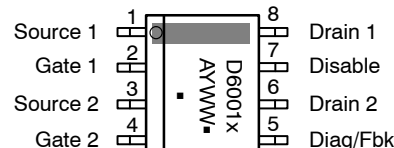

(Top View)

D6001x = Specific Device Code
x = N or A

A = Assembly Location

Y = Year

WW = Work Week

▪ = Pb-Free Package

(Note: Microdot may be in either location)

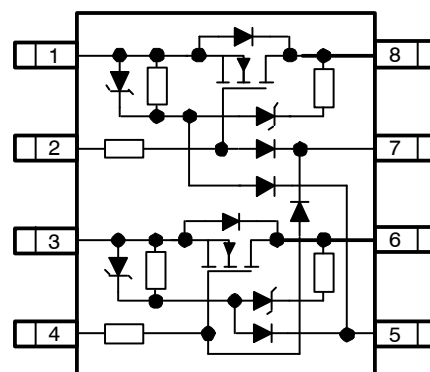

INTERNAL DIAGRAM

ORDERING INFORMATION

Device	Package	Shipping
NIMD6001NR2G	SOIC-8 (Pb-Free)	2500/Tape & Reel
NIMD6001ANR2G	SOIC-8 (Pb-Free)	2500/Tape & Reel

†For information on tape and reel specifications, including part orientation and tape sizes, please refer to our Tape and Reel Packaging Specification Brochure, BRD8011/D.

NIMD6001N, NIMD6001AN

PIN DESCRIPTIONS

Pin #	Symbol	Description
1	S1	FET 1 Source and Body
2	G1	FET 1 Gate
3	S2	FET 2 Source and Body
4	G2	FET 2 Gate
5	Diag/Fbk	Diagnostic Feedback – This pin will be logic high when either FET Drain-Source voltage exceeds the Drain Diagnostic threshold.
6	D2	FET 2 Drain
7	Disable	Gate Disable – Pull this pin low to disable both FETs. A logic low will override voltage applied to G1 or G2.
8	D1	FET 1 Drain

THERMAL RESISTANCE

Parameter	Symbol	Value	Units
Junction-to-Ambient – min. pad footprint (Notes 1 and 2)	$R_{\theta JA}$	96	°C/W
Junction-to-Ambient – 1" Cu pad (Notes 1 and 3)	$R_{\theta JA}$	75	

ELECTRICAL CHARACTERISTICS ($T_J = 25^\circ\text{C}$ unless otherwise specified)

Parameter	Symbol	Test Condition	Min	Typ	Max	Units
-----------	--------	----------------	-----	-----	-----	-------

OFF CHARACTERISTICS

Drain-to-Source Breakdown Voltage	$V_{(BR)DSS}$	$V_{GS} = 0\text{ V}; I_D = 5\text{ mA}$	60	67		V
Zero Gate Voltage Drain Current (Note 1)	I_{DSS}	$V_{GS} = 0\text{ V}; V_{DS} = 15\text{ V}$ $V_{GS} = 0\text{ V}; V_{DS} = 15\text{ V}; T_A = 150^\circ\text{C}$		10 80	20 250	μA
Gate Input Current	I_{GSS}	$V_{GS} = \pm 20\text{ V}; V_{DS} = 0\text{ V}$	-100	± 25	+100	nA

ON CHARACTERISTICS

Gate Threshold Voltage	$V_{GS(TH)}$	$V_{DS} = V_{GS}; I_D = 250\ \mu\text{A}$	1.0	1.7	3.0	
Static Drain-to-Source On-Resistance	$R_{DS(ON)}$	$V_{GS} = 10\text{ V}; I_D = 3.3\text{ A}$		60	110	$\text{m}\Omega$
Static Drain-to-Source On-Resistance	$R_{DS(ON)}$	$V_{GS} = 5\text{ V}; I_D = 3.0\text{ A}$		72	130	$\text{m}\Omega$

DYNAMIC CHARACTERISTICS (Note 1)

Input Capacitance	C_{ISS}	$V_{GS} = 0\text{ V}; V_{DS} = 15\text{ V};$ $f = 75\text{ kHz}$		150	175	pF
Output Capacitance	C_{OSS}			150	170	
Reverse Transfer Capacitance	C_{RSS}			25	30	
Gate Resistance	R_G			8	15	$\text{k}\Omega$
Total Gate Charge	$Q_{g(TOT)}$	$V_{GS} = 0\text{ V to } 5\text{ V}; V_{DD} = 30\text{ V};$ $I_D = 3.3\text{ A}; I_G = 1.0\text{ mA},$		8.3	9.0	nC
Gate-to-Source Gate Charge	Q_{gs}			1.1	1.6	
Gate-to-Drain Miller Charge	Q_{gd}			4.2	5	

1. These values are established by statistical characterization and may not be tested.
2. Surface-mounted on FR4 board using the minimum recommended pad size (Cu area = 40 sq. mm; 1 oz.)
3. Surface-mounted on FR4 board using 1 sq. inch heat spreader (Cu area = 625 sq. mm, 2 oz.)
4. Refer to Figure 1 for definition of switching characteristics symbols.

NIMD6001N, NIMD6001AN

ELECTRICAL CHARACTERISTICS (T_J = 25°C unless otherwise specified)

Parameter	Symbol	Test Condition	Min	Typ	Max	Units
-----------	--------	----------------	-----	-----	-----	-------

SWITCHING CHARACTERISTICS (Notes 1 and 4)

Turn-On Time	T(on)	V _{GS} = 10 V; V _{DD} = 30 V; I _D = 3.3 A, Ext. R _{GS} = 47 Ω		6.0	8.0	μs
Turn-On Delay	Td(on)			1.7		
Rise Time	Tr			3.9		
Turn-Off Time	T(off)			24	28	
Turn-Off Delay	Td(off)			15		
Fall Time	Tf			9.0		

BODY DIODE

Source-Drain Forward On Voltage	V _{SD}	V _{GS} = 0 V, I _{SD} = 3.3 A		0.85	1.25	V
---------------------------------	-----------------	------------------------------------------------	--	------	------	---

DIAGNOSTIC FEEDBACK (Note 1)

Feedback voltage	V _{FBK}	V _{DS} = 35 V, R _{FBK-SOURCE} = 51 kΩ			1.7	V
Feedback Logical High voltage	V _{FBK(HI)}	V _{DS} = 60 V, R _{FBK-SOURCE} = 51 kΩ	3.0		5.5	V
V _{DS} threshold voltage for logical High	V _{DSEBK(HI)}	Ramp V _{DS} positive until V _{FBK} = 3.5 V	45		65	V
V _{DS} threshold voltage for logical Low	V _{DSEBK(LOW)}	Ramp V _{DS} negative until V _{FBK} = 0.8 V	25		45	V

DISABLE (Note 1)

Gate Drive Disable Input Voltage, Gate Enable	V _{DIS(HI)}	V _{DIS} ≥ 3.0 V, V _{GS} = 5 V, I _D = 3.0 A	3			V
Gate Drive Disable Input Voltage, Gate Disable	V _{DIS(LOW)}	V _{DIS} ≤ 0.4 V, V _{GS} = V _{DS} = 10 V, I _D ≤ 250 μA; T _J = 150°C (Note 1)			0.4	V

1. These values are established by statistical characterization and may not be tested.
2. Surface-mounted on FR4 board using the minimum recommended pad size (Cu area = 40 sq. mm; 1 oz.)
3. Surface-mounted on FR4 board using 1 sq. inch heat spreader (Cu area = 625 sq. mm, 2 oz.)
4. Refer to Figure 1 for definition of switching characteristics symbols.

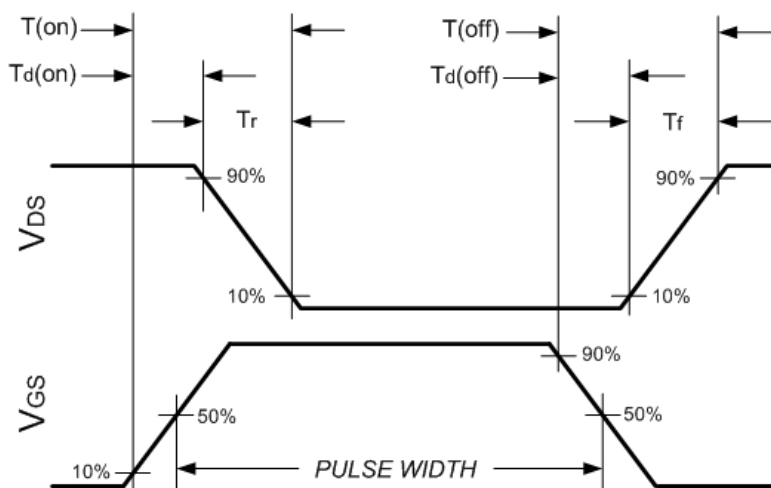

Figure 1. Switching Characteristics Waveforms and Symbols

NIMD6001N, NIMD6001AN

TYPICAL ELECTRICAL CHARACTERISTICS

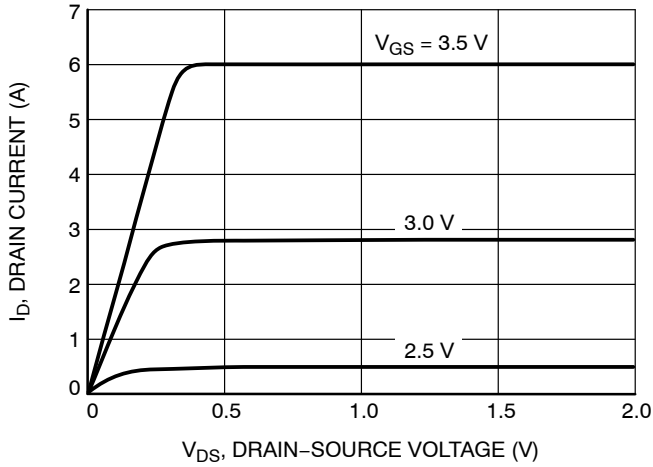

Figure 2. Drain Current vs. Drain-Source Voltage and Gate-Source Voltage

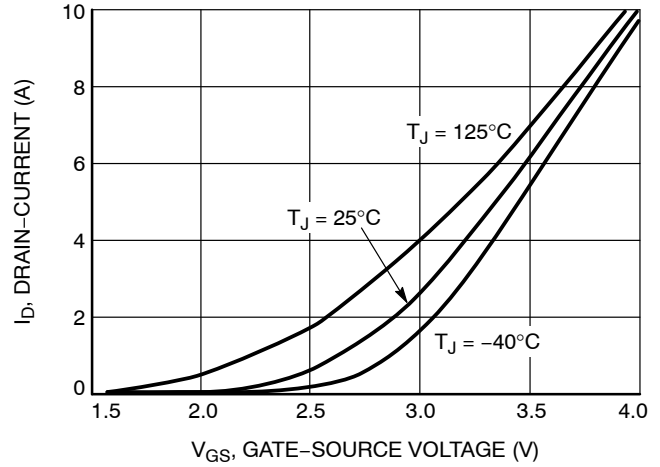

Figure 3. Transfer Function (pulsed). Pulse duration = 80 μ s, duty cycle < 0.5%; $V_{DS} = 2$ V

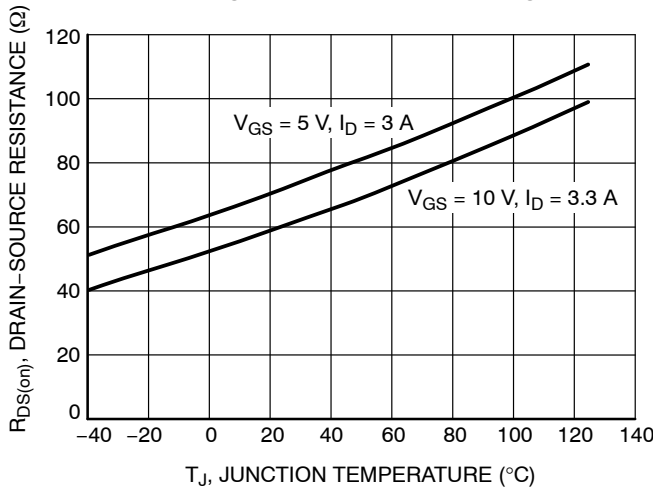

Figure 4. Drain-Source On Resistance vs. Junction Temperature

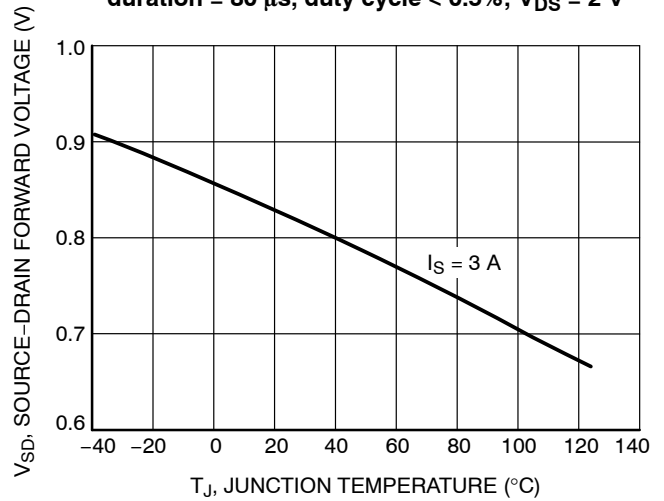

Figure 5. Body Diode Forward Voltage vs. Junction Temperature

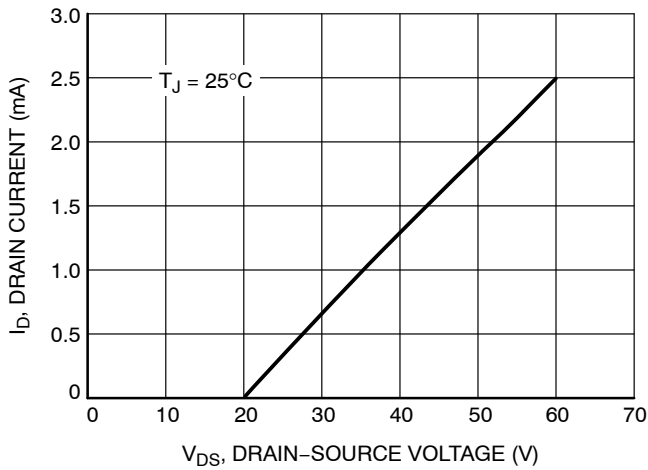

Figure 6. Off-State Drain Current vs. Drain-Source Voltage (includes feedback network current)

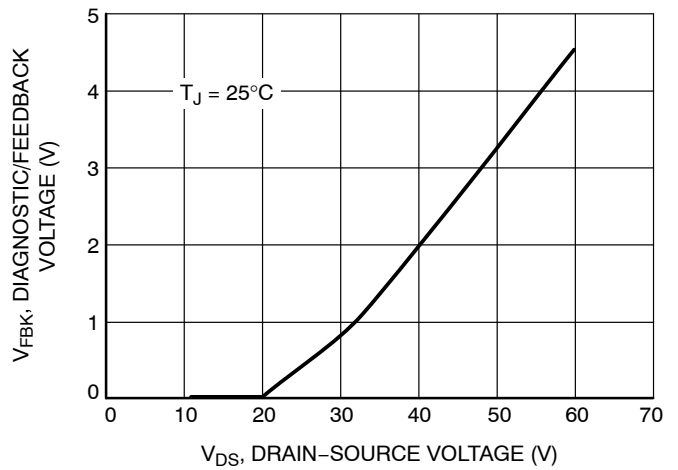

Figure 7. Diagnostic Feedback Voltage vs. Drain-Source Voltage

NIMD6001N, NIMD6001AN

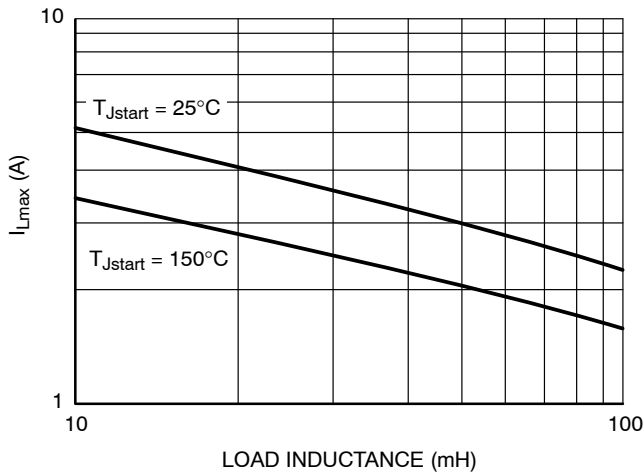

Figure 8. Single Pulse Maximum Switch-off Current vs. Load Inductance

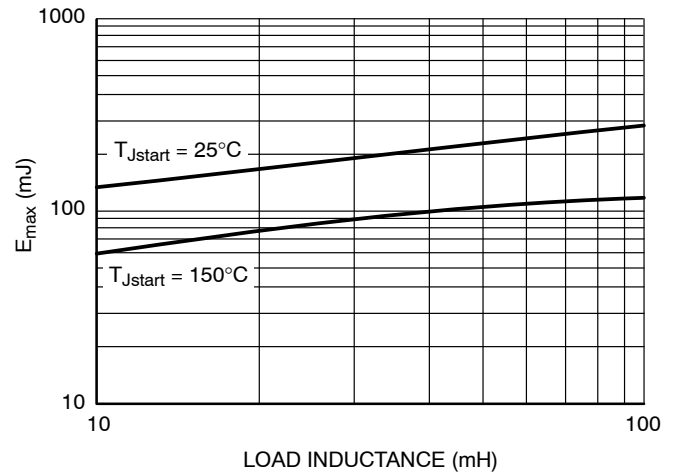

Figure 9. Single Pulse Maximum Switching Energy vs. Load Inductance

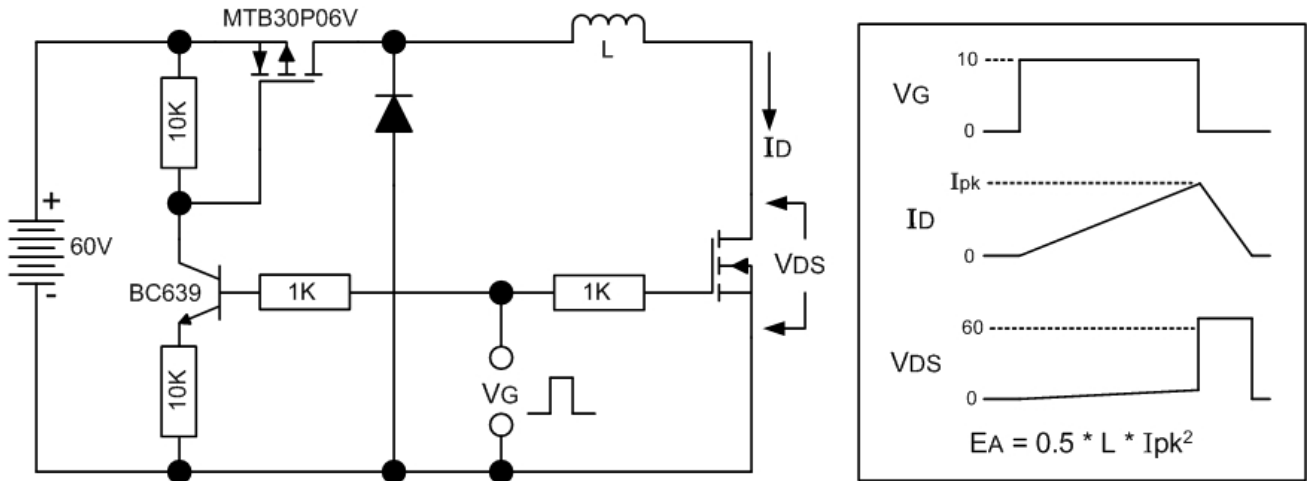

Figure 10. Single Pulse Peak Drain Current and Avalanche Energy Test Circuit

NIMD6001N, NIMD6001AN

TYPICAL THERMAL RESPONSE CHARACTERISTICS

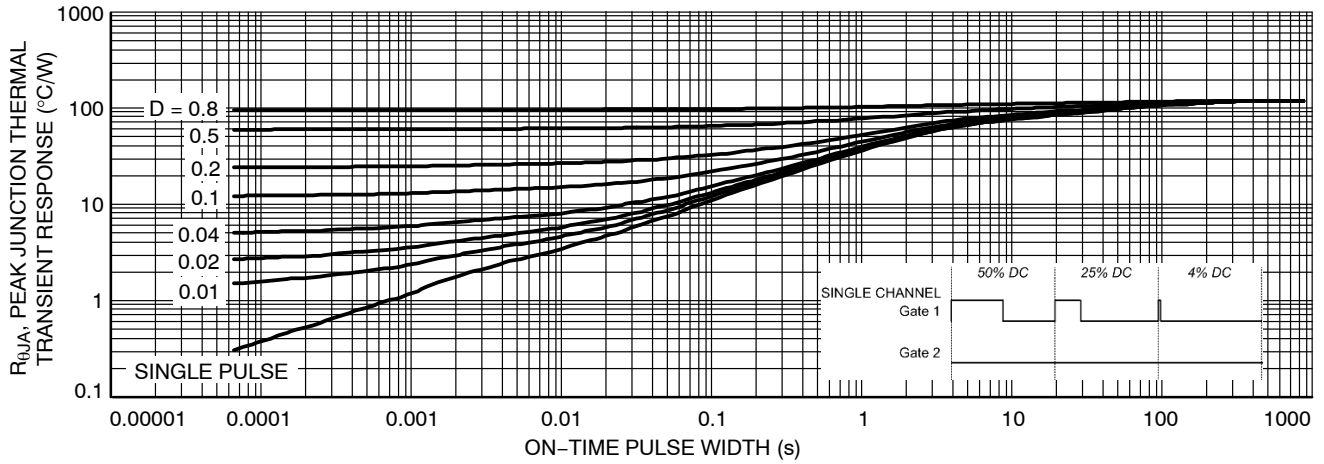

Figure 11. Single Channel Active; Mounted on Minimum-Pad Board

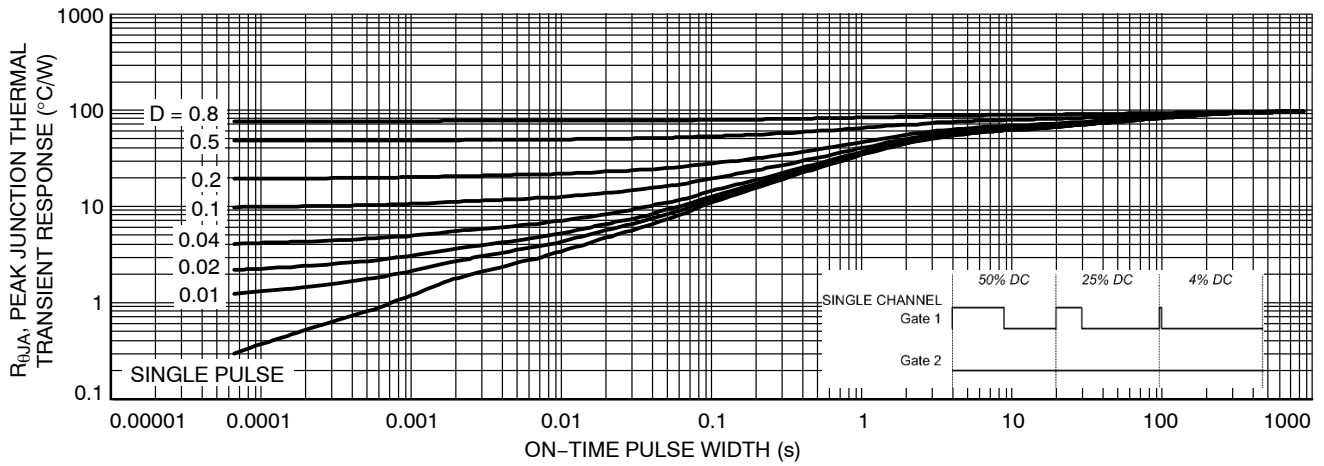

Figure 12. Single Channel Active; Mounted on 1 Sq. Inch Copper Spreader

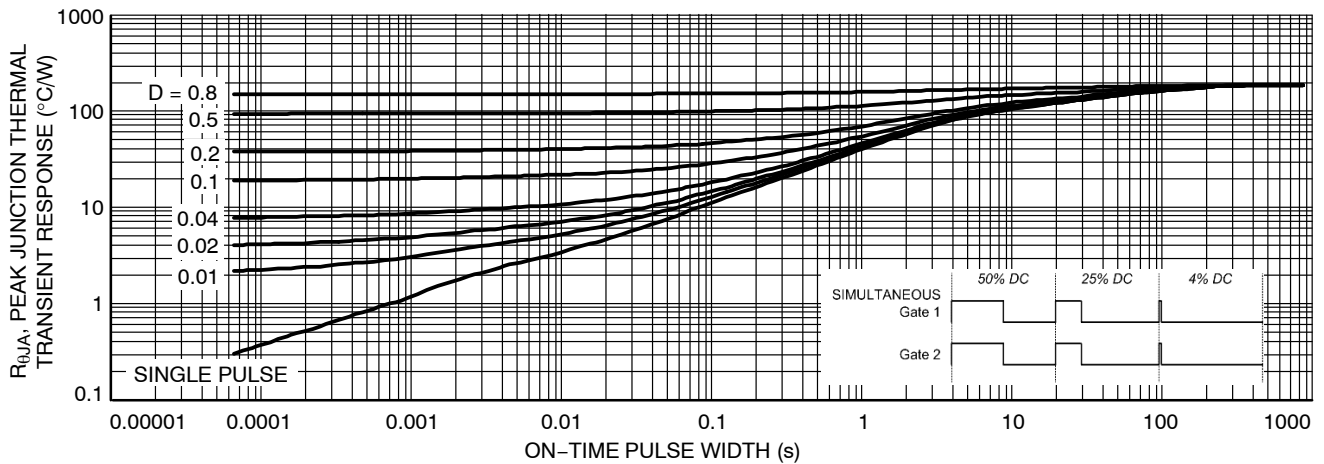

Figure 13. Both Channels Active; Mounted on Minimum-Pad Board

NIMD6001N, NIMD6001AN

TYPICAL THERMAL RESPONSE CHARACTERISTICS

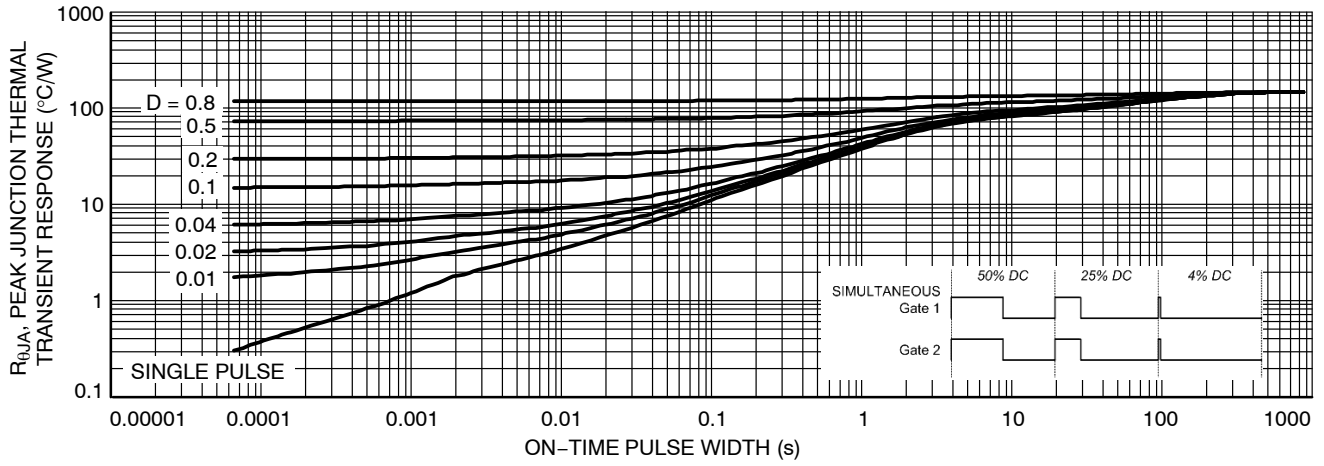

Figure 14. Both Channels Active; Mounted on 1 Sq. Inch Copper Spreader

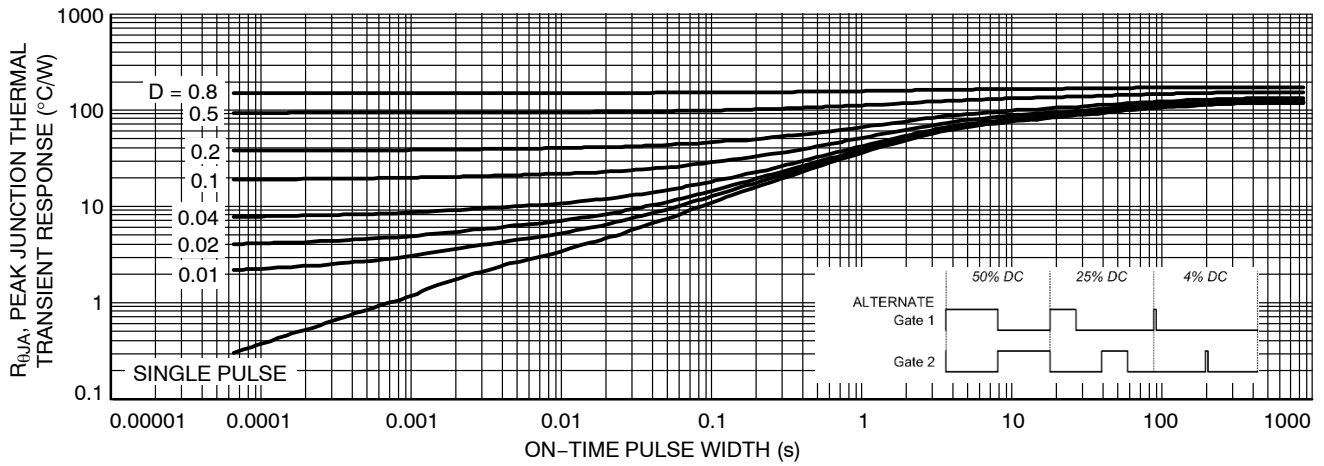

Figure 15. Channels Alternately Active; Mounted on Minimum-Pad Board

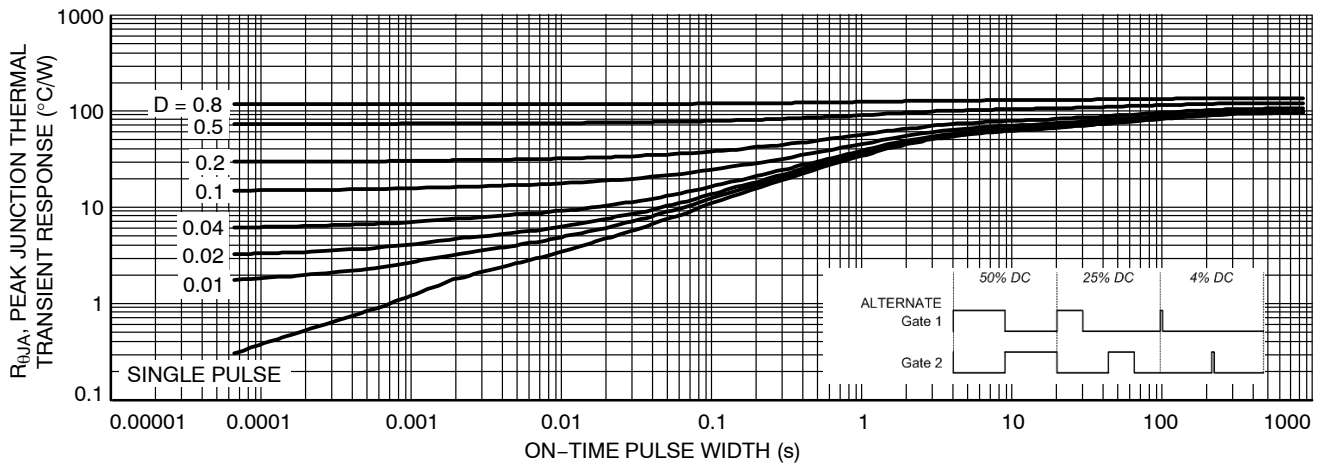

Figure 16. Channels Alternately Active; Mounted on 1 Sq. Inch Copper Spreader

NIMD6001N, NIMD6001AN

TYPICAL APPLICATION CIRCUIT

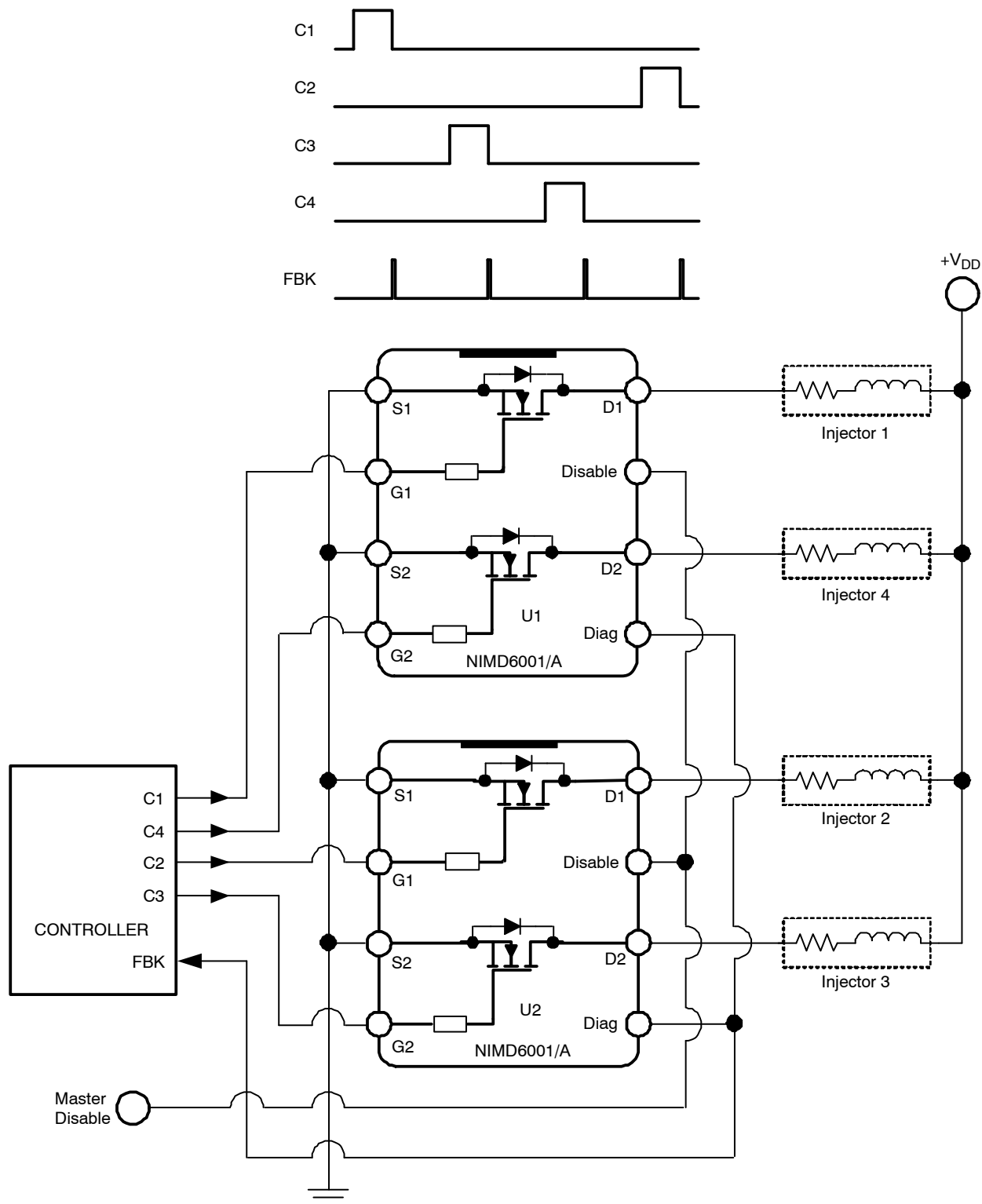

Figure 17. 4 Cylinder Engine Fuel Injection

- 4-Cycle engine; 1 injector pulse during intake stroke
- To optimize transient thermal resistance of the NIMD6001/A devices, the injector drive pulses are alternated between U1 and U2.
- Cylinder firing order is 1-3-4-2
- The coincident FBK pulse will be missing if any injector is open or shorted.

NIMD6001N, NIMD6001AN

PACKAGE DIMENSIONS

SOIC-8 NB CASE 751-07 ISSUE AK

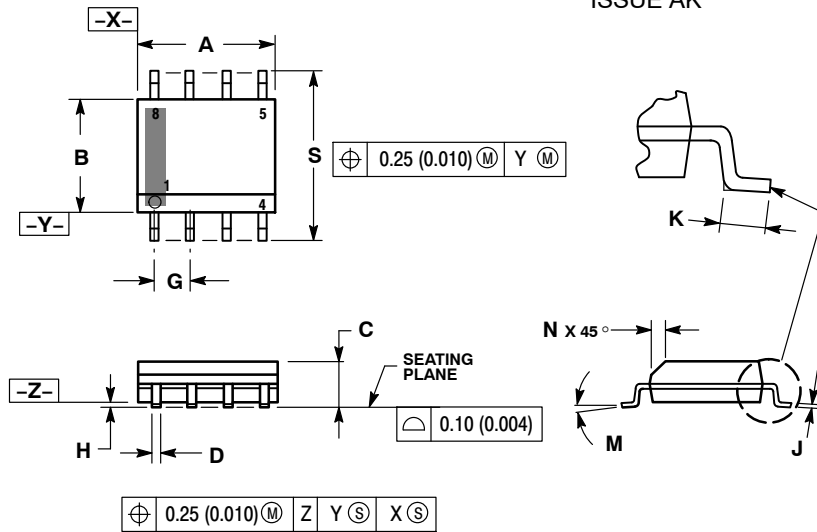

NOTES:

1. DIMENSIONING AND TOLERANCING PER ANSI Y14.5M, 1982.
2. CONTROLLING DIMENSION: MILLIMETER.
3. DIMENSION A AND B DO NOT INCLUDE MOLD PROTRUSION.
4. MAXIMUM MOLD PROTRUSION 0.15 (0.006) PER SIDE.
5. DIMENSION D DOES NOT INCLUDE DAMBAR PROTRUSION. ALLOWABLE DAMBAR PROTRUSION SHALL BE 0.127 (0.005) TOTAL IN EXCESS OF THE D DIMENSION AT MAXIMUM MATERIAL CONDITION.
6. 751-01 THRU 751-06 ARE OBSOLETE. NEW STANDARD IS 751-07.

DIM	MILLIMETERS		INCHES	
	MIN	MAX	MIN	MAX
A	4.80	5.00	0.189	0.197
B	3.80	4.00	0.150	0.157
C	1.35	1.75	0.053	0.069
D	0.33	0.51	0.013	0.020
G	1.27 BSC		0.050 BSC	
H	0.10	0.25	0.004	0.010
J	0.19	0.25	0.007	0.010
K	0.40	1.27	0.016	0.050
M	0°	8°	0°	8°
N	0.25	0.50	0.010	0.020
S	5.80	6.20	0.228	0.244

SOLDERING FOOTPRINT*

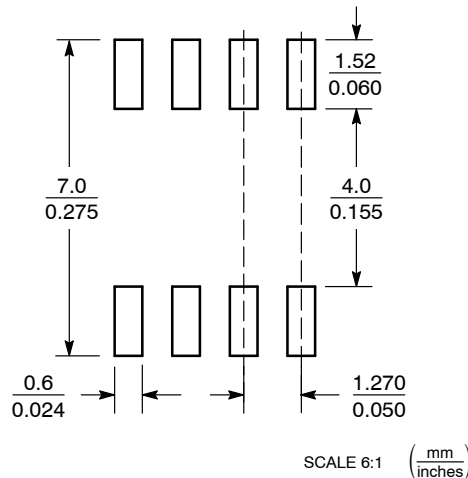

*For additional information on our Pb-Free strategy and soldering details, please download the ON Semiconductor Soldering and Mounting Techniques Reference Manual, SOLDERRM/D.

ON Semiconductor and are registered trademarks of Semiconductor Components Industries, LLC (SCILLC). SCILLC reserves the right to make changes without further notice to any products herein. SCILLC makes no warranty, representation or guarantee regarding the suitability of its products for any particular purpose, nor does SCILLC assume any liability arising out of the application or use of any product or circuit, and specifically disclaims any and all liability, including without limitation special, consequential or incidental damages. "Typical" parameters which may be provided in SCILLC data sheets and/or specifications can and do vary in different applications and actual performance may vary over time. All operating parameters, including "Typicals" must be validated for each customer application by customer's technical experts. SCILLC does not convey any license under its patent rights nor the rights of others. SCILLC products are not designed, intended, or authorized for use as components in systems intended for surgical implant into the body, or other applications intended to support or sustain life, or for any other application in which the failure of the SCILLC product could create a situation where personal injury or death may occur. Should Buyer purchase or use SCILLC products for any such unintended or unauthorized application, Buyer shall indemnify and hold SCILLC and its officers, employees, subsidiaries, affiliates, and distributors harmless against all claims, costs, damages, and expenses, and reasonable attorney fees arising out of, directly or indirectly, any claim of personal injury or death associated with such unintended or unauthorized use, even if such claim alleges that SCILLC was negligent regarding the design or manufacture of the part. SCILLC is an Equal Opportunity/Affirmative Action Employer. This literature is subject to all applicable copyright laws and is not for resale in any manner.

PUBLICATION ORDERING INFORMATION

LITERATURE FULFILLMENT:
Literature Distribution Center for ON Semiconductor
P.O. Box 5163, Denver, Colorado 80217 USA
Phone: 303-675-2175 or 800-344-3860 Toll Free USA/Canada
Fax: 303-675-2176 or 800-344-3867 Toll Free USA/Canada
Email: orderlit@onsemi.com

N. American Technical Support: 800-282-9855 Toll Free USA/Canada
Europe, Middle East and Africa Technical Support:
Phone: 421 33 790 2910
Japan Customer Focus Center
Phone: 81-3-5817-1050

ON Semiconductor Website: www.onsemi.com
Order Literature: <http://www.onsemi.com/orderlit>

For additional information, please contact your local Sales Representative