

**High and Low Side Driver**

**Features**

- Floating channel designed for bootstrap operation
- Fully operational to +600V
- Tolerant to negative transient voltage
- dV/dt immune
- Gate drive supply range from 10 to 20V
- Undervoltage lockout for both channels
- 3.3V logic compatible
- Separate logic supply range from 3.3V to 20V
- Logic and power ground  $\pm 5V$  offset
- CMOS Schmitt-triggered inputs with pull-down
- Cycle by cycle edge-triggered shutdown logic
- Matched propagation delay for both channels
- Outputs in phase with inputs

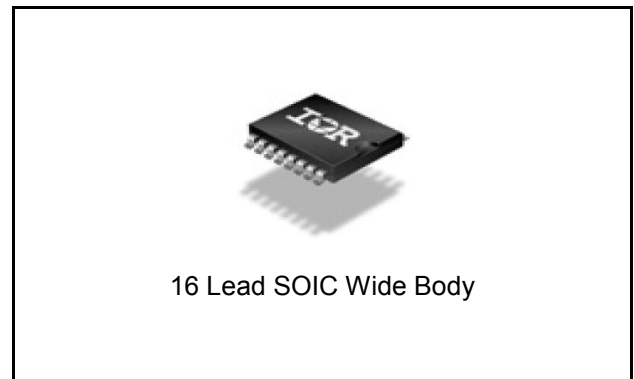
**Description**

The IR25607 is a high voltage, high speed power MOSFET and IGBT driver with independent high and low side referenced output channels. Proprietary HVIC and latch immune CMOS technologies enable ruggedized monolithic construction. Logic inputs are compatible with standard CMOS or LSTTL output, down to 3.3V logic. The output drivers feature a high pulse current buffer stage designed for minimum driver cross-conduction. Propagation delays are matched to simplify use in high frequency applications. The floating channel can be used to drive an N-channel power MOSFET or IGBT in the high side configuration which operates up to 600 V.

**Product Summary**

$V_{OFFSET}$	600V max.
$I_{O+/-}$	2A / 2A
$V_{OUT}$	10 – 20V
Ton/off (typ.)	120 & 94 ns
Delay Matching (typ.)	20 ns

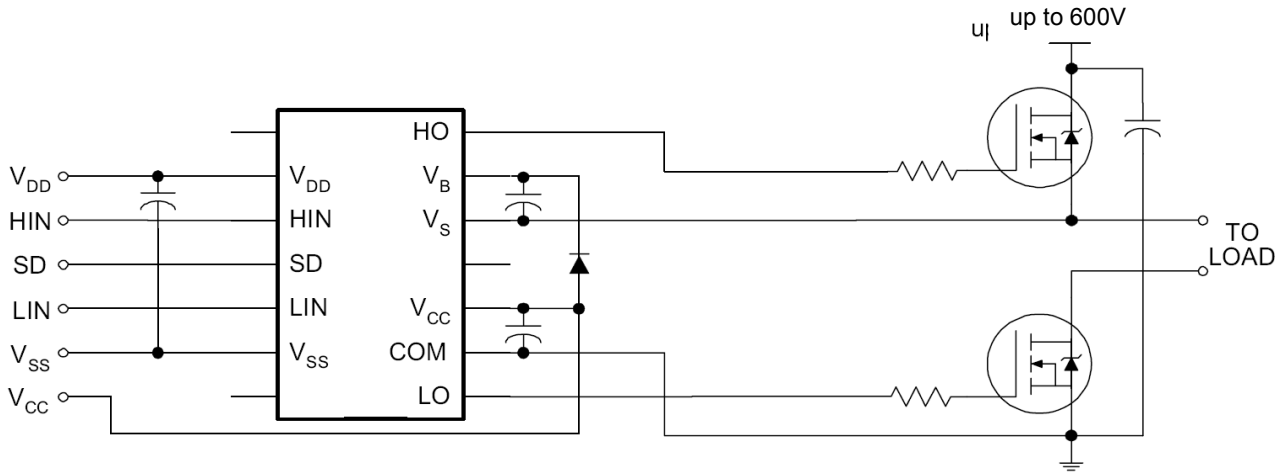
**Package Options**



**Ordering Information**

Base Part Number	Package Type	Standard Pack		Orderable Part Number
		Form	Quantity	
IR25607SPBF	SO16W	Tube	45	IR25607SPBF
IR25607SPBF	SO16W	Tape and Reel	1000	IR25607STRPBF

**Typical Connection Diagram**



(Refer to Lead Assignments for correct pin configuration). This/These diagram(s) show electrical connections only. Please refer to our Application Notes and DesignTips for proper circuit board layout.

## Absolute Maximum Ratings

Absolute maximum ratings indicate sustained limits beyond which damage to the device may occur. All voltage parameters are absolute voltages referenced to COM. The thermal resistance and power dissipation ratings are measured under board mounted and still air conditions.

Symbol	Definition	Min.	Max.	Units
$V_B$	High side floating supply voltage	-0.3	625	V
$V_S$	High side floating supply offset voltage	$V_B - 25$	$V_B + 0.3$	
$V_{HO}$	High side floating output voltage	$V_S - 0.3$	$V_B + 0.3$	
$V_{CC}$	Low side and logic fixed supply voltage	-0.3	25	
$V_{LO}$	Low side output voltage	-0.3	$V_{CC} + 0.3$	
$V_{DD}$	Logic supply voltage	-0.3	$V_{SS} + 25$	
$V_{SS}$	Logic supply offset voltage	$V_{CC} - 25$	$V_{CC} + 0.3$	
$V_{IN}$	Logic input voltage (HIN, LIN & SD )	$V_{SS} - 0.3$	$V_{DD} + 0.3$	
dVs/dt	Allowable offset supply voltage transient	—	50	V/ns
$P_D$	Package power dissipation @ $T_A \leq +25^\circ\text{C}$	—	1.25	W
$R_{thJA}$	Thermal resistance, junction to ambient	—	100	$^\circ\text{C/W}$
$T_J$	Junction temperature	—	150	$^\circ\text{C}$
$T_S$	Storage temperature	-55	150	
$T_L$	Lead temperature (soldering, 10 seconds)	—	300	

## Recommended Operating Conditions

For proper operation the device should be used within the recommended conditions. The  $V_S$  and  $V_{SS}$  offset ratings are tested with all supplies biased at 15V differential.

Symbol	Definition	Min.	Max.	Units
$V_B$	High side floating supply absolute voltage	$V_S + 10$	$V_S + 20$	V
$V_S$	High side floating supply offset voltage	†	600	
$V_{HO}$	High side floating output voltage	$V_S$	$V_B$	
$V_{CC}$	Low side fixed supply voltage	10	20	
$V_{LO}$	Low side output voltage	0	$V_{CC}$	
$V_{DD}$	Logic supply voltage	$V_{SS} + 3$	$V_{SS} + 20$	
$V_{SS}$	Logic supply offset voltage	-5 ††	5	
$V_{IN}$	Logic input voltage (HIN, LIN & SD )	$V_{SS}$	$V_{DD}$	
$T_A$	Ambient temperature	-40	125	$^\circ\text{C}$

† Logic operational for  $V_S$  of -5 to +600V. Logic state held for  $V_S$  of -5V to -VBS. (Please refer to Design Tip DT97-3 for more details).

†† When  $V_{DD} < 5\text{V}$ , the minimum  $V_{SS}$  offset is limited to  $-V_{DD}$ .

### Dynamic Electrical Characteristics

$V_{BIAS}$  ( $V_{CC}$ ,  $V_{BS}$ ,  $V_{DD}$ ) = 15V,  $C_L$  = 1000 pF,  $V_{SS}$  = COM and  $T_A$  = 25°C unless otherwise specified.

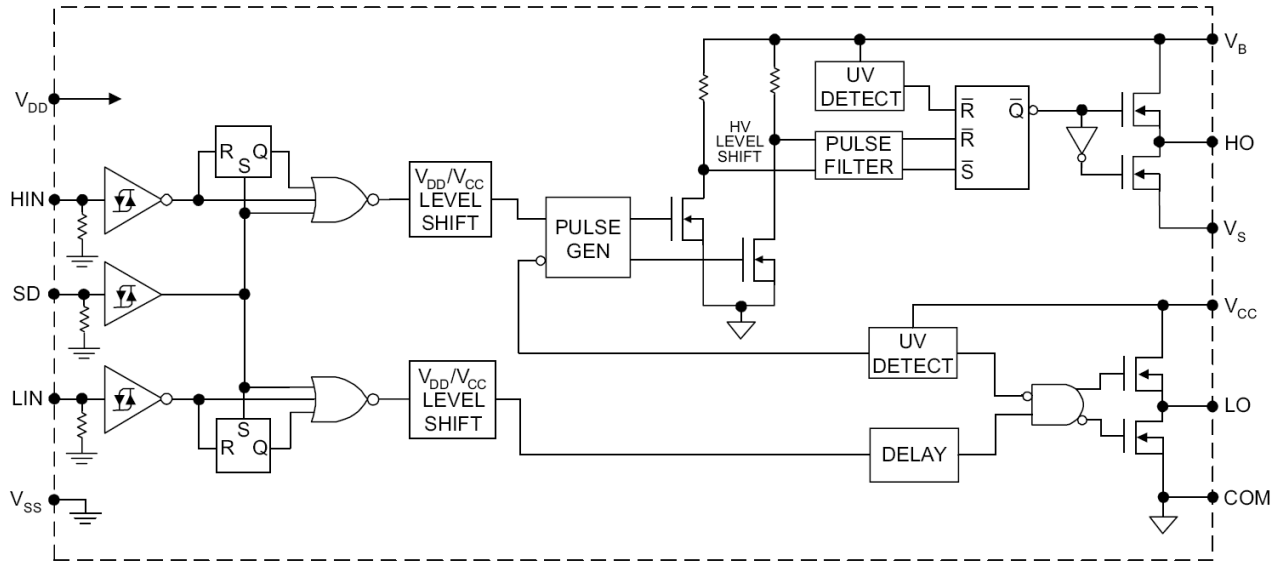
Symbol	Definition	Min.	Typ.	Max.	Units	Test Conditions
$t_{on}$	Turn-on propagation delay	—	120	150	ns	$V_S = 0V$
$t_{off}$	Turn-off propagation delay	—	94	125		$V_S = 600V$
$t_{sd}$	Shutdown propagation delay	—	110	140		$V_S = 600V$
$t_r$	Turn-on rise time	—	25	35		
$t_f$	Turn-off fall time	—	17	25		
MT	Delay matching, HS & LS turn-on/off	—	—	20		

### Static Electrical Characteristics

$V_{BIAS}$  ( $V_{CC}$ ,  $V_{BS}$ ,  $V_{DD}$ ) = 15V,  $V_{SS}$  = COM and  $T_A$  = 25°C unless otherwise specified. The  $V_{IN}$ ,  $V_{TH}$  and  $I_{IN}$  parameters are referenced to  $V_{SS}$  and are applicable to all three logic input leads: HIN, LIN and SD. The  $V_O$  and  $I_O$  parameters are referenced to COM and are applicable to the respective output leads: HO and LO.

Symbol	Definition	Min.	Typ.	Max.	Units	Test Conditions
$V_{IH}$	Logic "1" input voltage	9.5	—	—	V	
$V_{IL}$	Logic "0" input voltage	—	—	6.0		
$V_{OH}$	High level output voltage, $V_{BIAS} - V_O$	—	—	1.2		$I_O = 0A$
$V_{OL}$	Low level output voltage, $V_O$	—	—	0.1		$I_O = 0A$
$I_{LK}$	Offset supply leakage current	—	—	50	$\mu A$	$V_B = V_S = 600V$
$I_{QBS}$	Quiescent $V_{BS}$ supply current	—	125	230		$V_{IN} = 0V$ or $V_{DD}$
$I_{QCC}$	Quiescent $V_{CC}$ supply current	—	180	340		$V_{IN} = 0V$ or $V_{DD}$
$I_{QDD}$	Quiescent $V_{CC}$ supply current	—	15	30		$V_{IN} = 0V$ or $V_{DD}$
$I_{IN+}$	Logic "1" input bias current	—	20	40		$V_{IN} = V_{DD}$
$I_{IN-}$	Logic "0" input bias current	—	—	1		$V_{IN} = 0V$
$V_{BSUV+}$	$V_{BS}$ supply undervoltage positive going threshold	7.5	8.6	9.7	V	
$V_{BSUV-}$	$V_{BS}$ supply undervoltage negative going threshold	7.0	8.2	9.4		
$V_{CCUV+}$	$V_{CC}$ supply undervoltage positive going threshold	7.4	8.5	9.6		
$V_{CCUV-}$	$V_{CC}$ supply undervoltage negative going threshold	7.0	8.2	9.4		
$I_{O+}$	Output high short circuit pulsed current	2	2.5	—	A	$V_O = 0V$ , $V_{IN} = V_{DD}$ $PW \leq 10 \mu s$
$I_{O-}$	Output low short circuit pulsed current	2	2.5	—		$V_O = 15V$ , $V_{IN} = V_{DD}$ $PW \leq 10 \mu s$

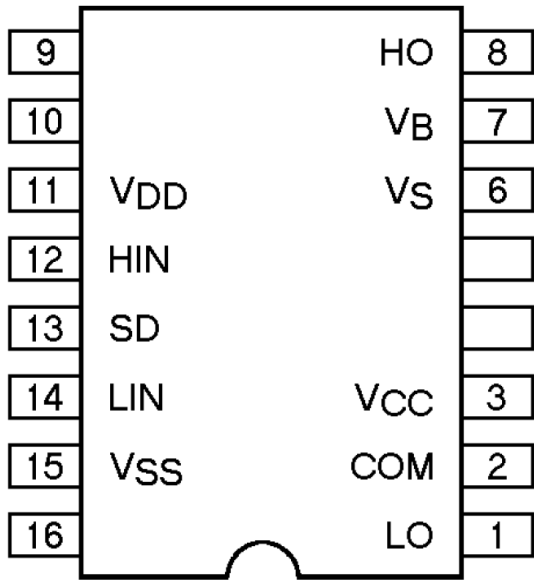
**Functional Block Diagram**



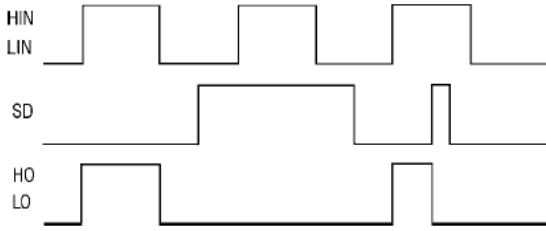
**Lead Definitions**

Symbol	Description
V <sub>DD</sub>	Logic supply
HIN	Logic input for high side gate driver output (HO), in phase
SD	Logic input for shutdown
LIN	Logic input for low side gate driver output (LO), in phase
V <sub>SS</sub>	Logic ground
V <sub>B</sub>	High side floating supply
HO	High side gate drive output
V <sub>S</sub>	High side floating supply return
V <sub>CC</sub>	Low side and logic fixed supply
LO	Low side gate drive output
COM	Low side return

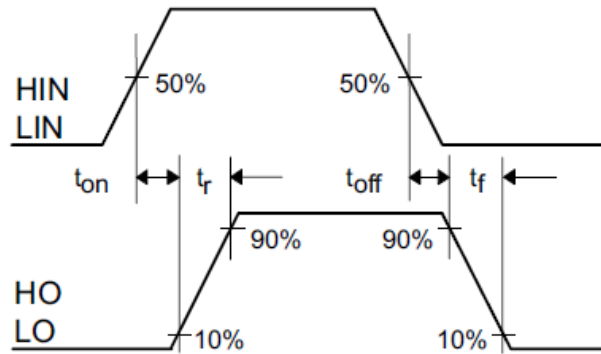
**Lead Assignments**



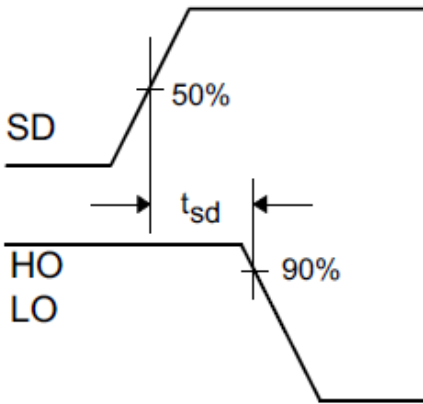
**Application Information and Additional Details**



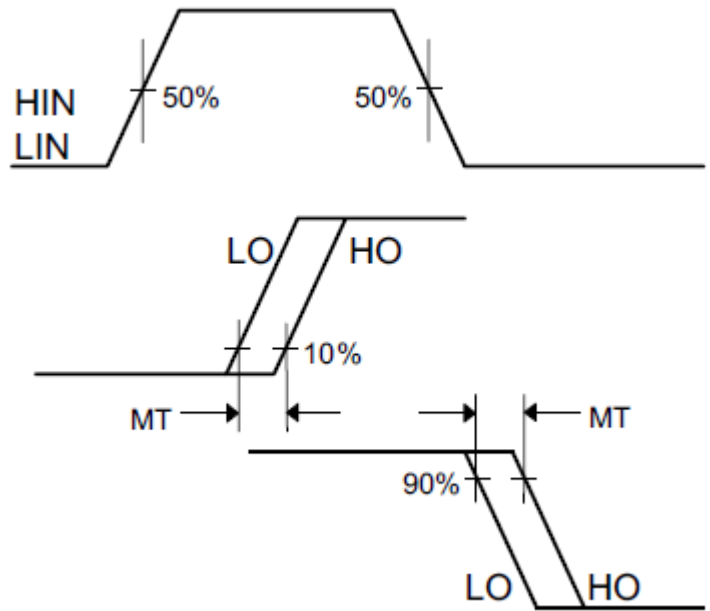
**Figure 1. Input/Output Timing Diagram**



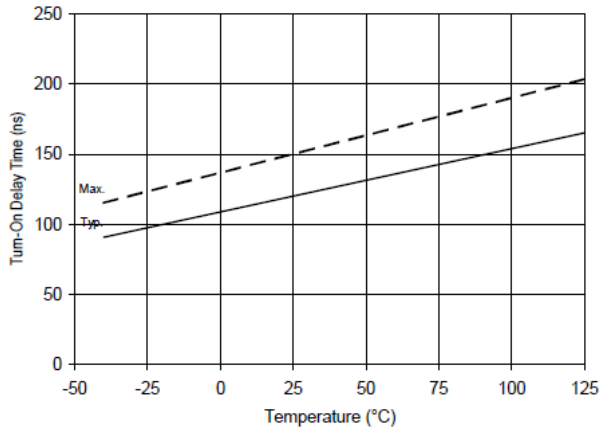
**Figure 2. Switching Time Waveform Definitions**



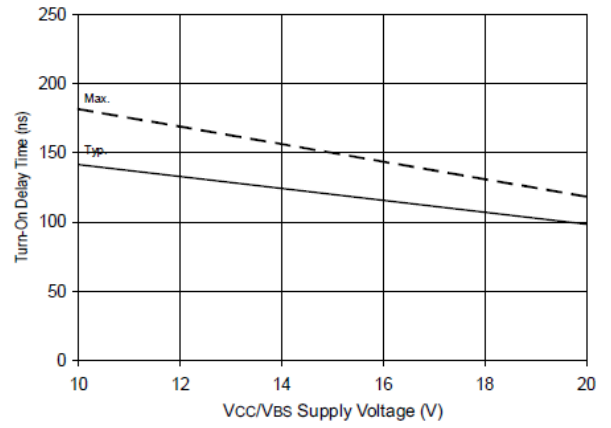
**Figure 3. Shutdown Waveform Definitions**



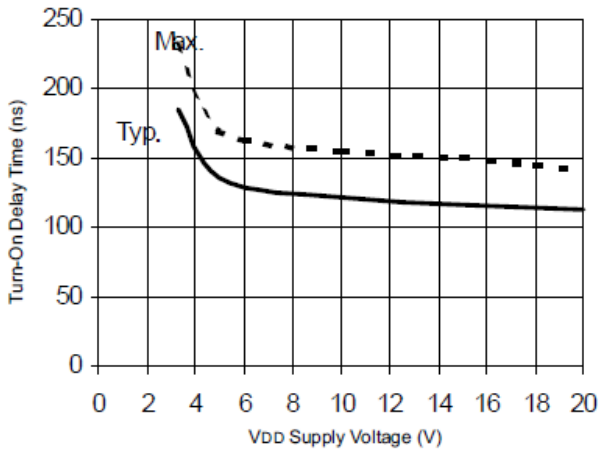
**Figure 4. Delay matching Waveform Definitions**



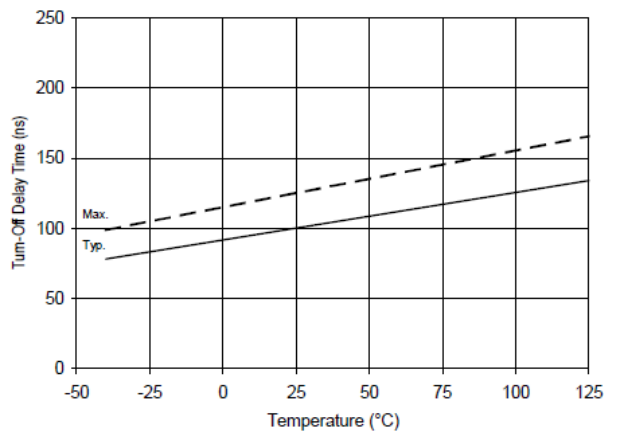
**Figure 5A. Turn On Time vs. Temperature**



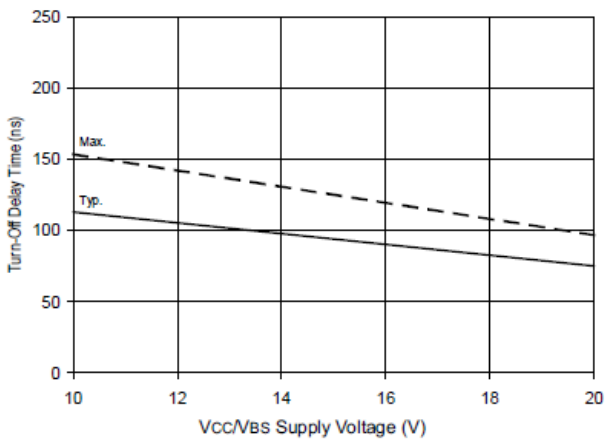
**Figure 5B. Turn On Time vs. V<sub>CC</sub>/V<sub>BS</sub> Supply Voltage**



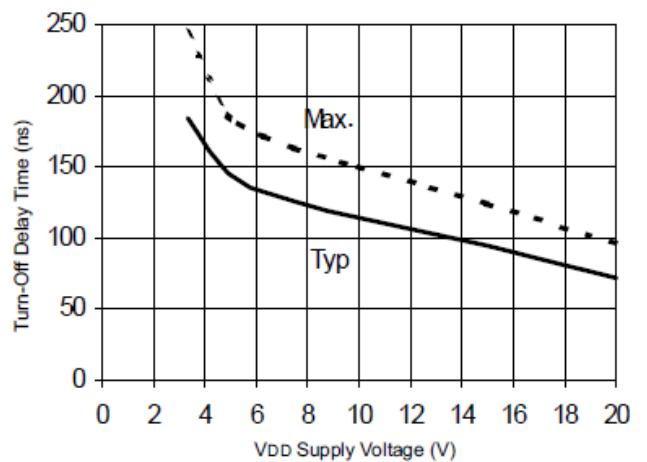
**Figure 5C. Turn On Time vs. V<sub>DD</sub> Supply Voltage**



**Figure 6A. Turn Off Time vs. Temperature**

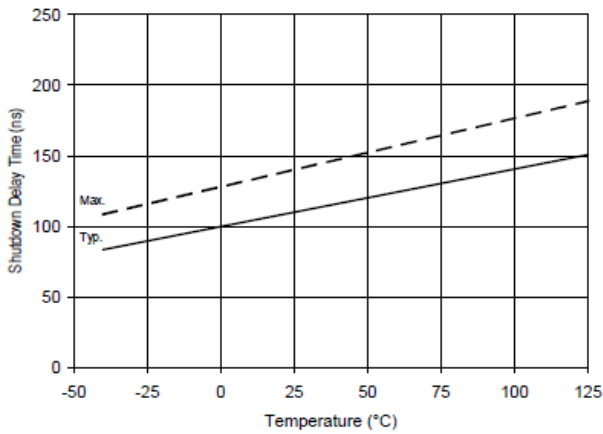


**Figure 6B. Turn Off Time vs. V<sub>CC</sub>/V<sub>BS</sub> Supply Voltage**

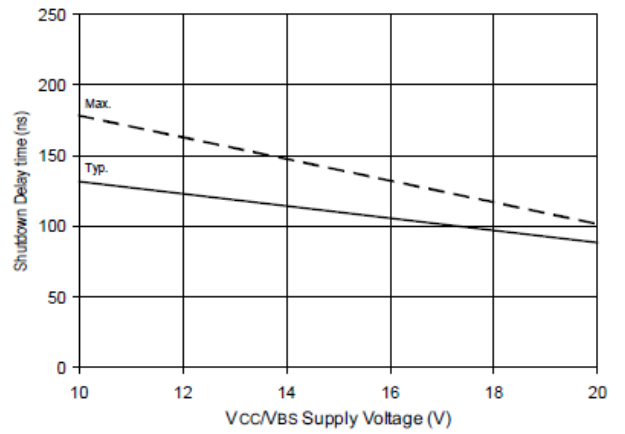


**Figure 6C. Turn Off Time vs. V<sub>DD</sub> Supply Voltage**

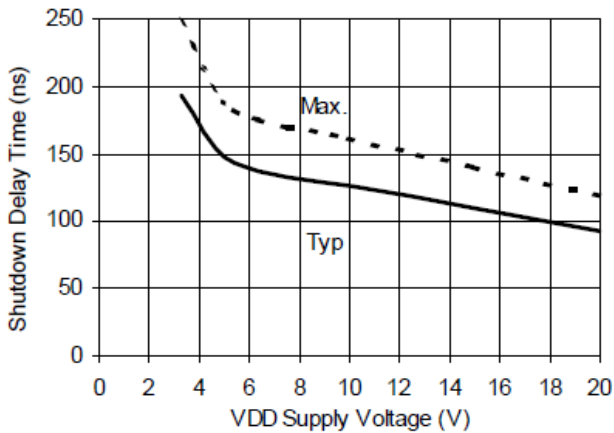




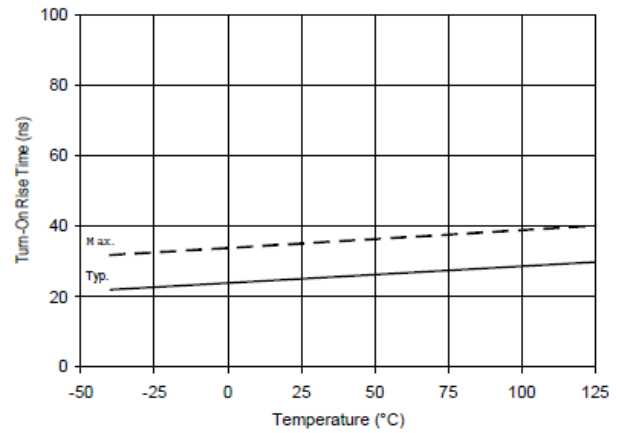
**Figure 7A. Shutdown Time vs. Temperature**



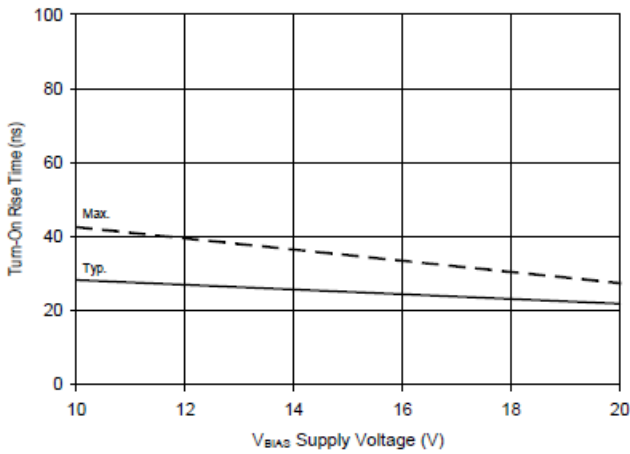
**Figure 7B. Shutdown Time vs.  $V_{CC}/V_{BS}$  Supply Voltage**



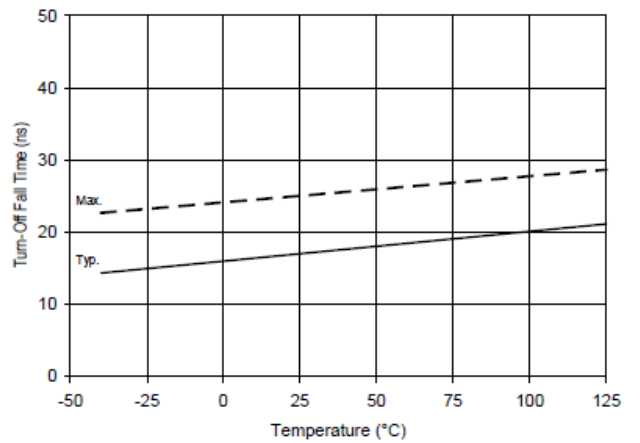
**Figure 7C. Shutdown Time vs.  $V_{DD}$  Supply Voltage**



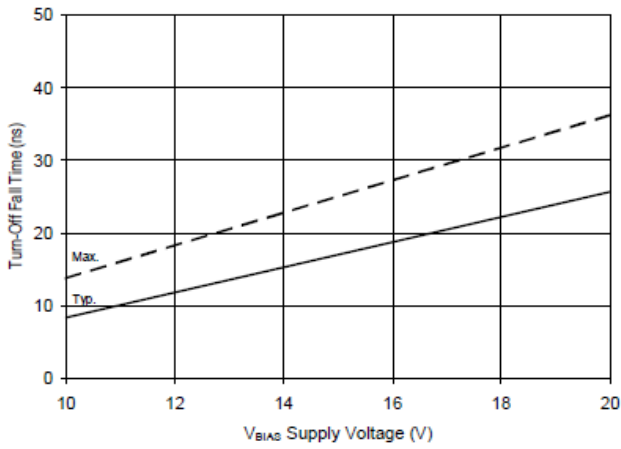
**Figure 8A. Turn On Rise Time vs. Temperature**



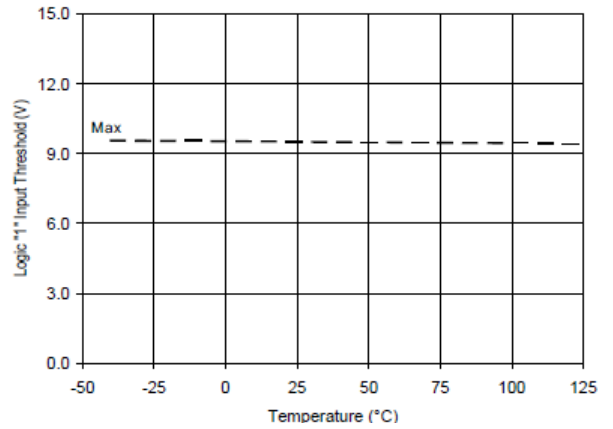
**Figure 8B. Turn On Rise Time vs. Voltage**



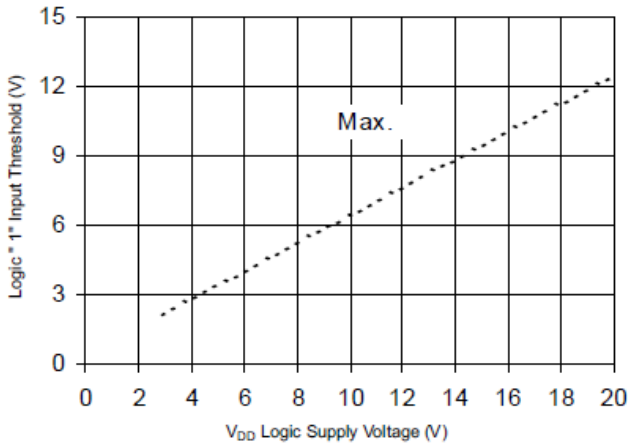
**Figure 9A. Turn Off Fall Time vs. Temperature**



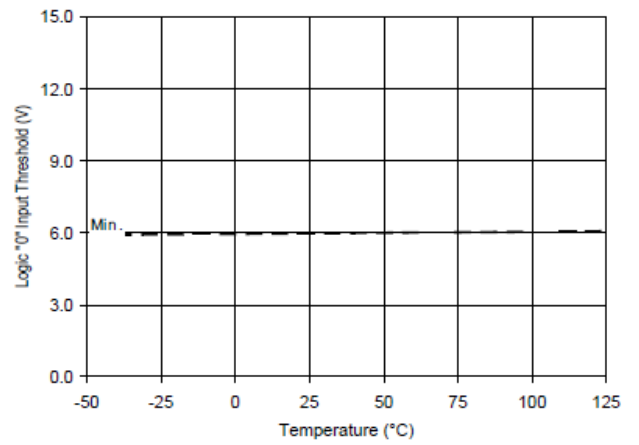
**Figure 9B. Turn Off Fall Time vs. Voltage**



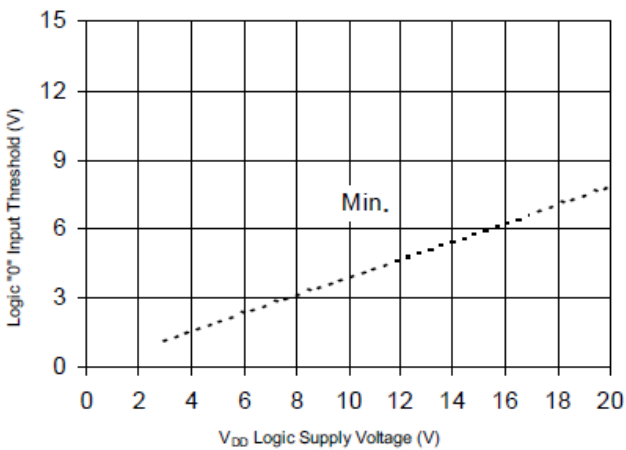
**Figure 10A. Logic '1' Input Threshold vs. Temperature**



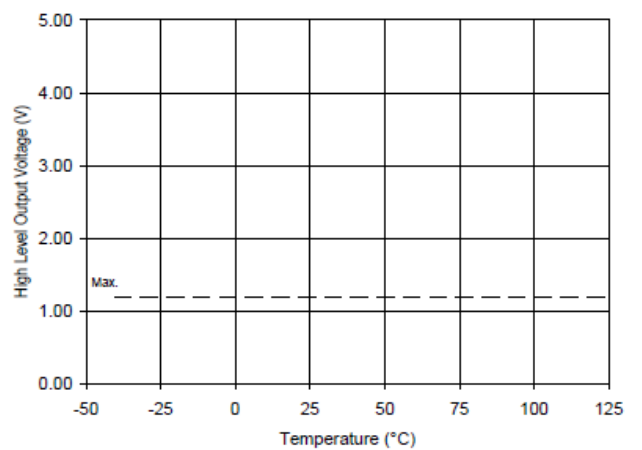
**Figure 10B. Logic '1' Input Threshold vs. Voltage**



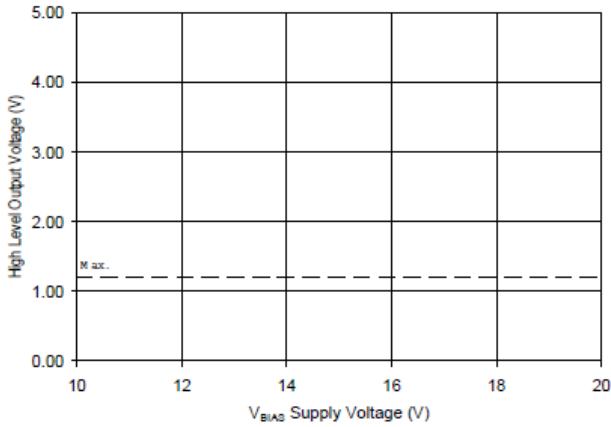
**Figure 11A. Logic '0' Input Threshold vs. Temperature**



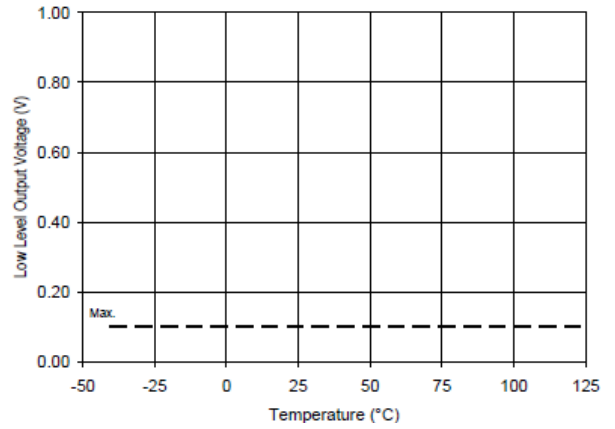
**Figure 11B. Logic '0' Input Threshold vs. Voltage**



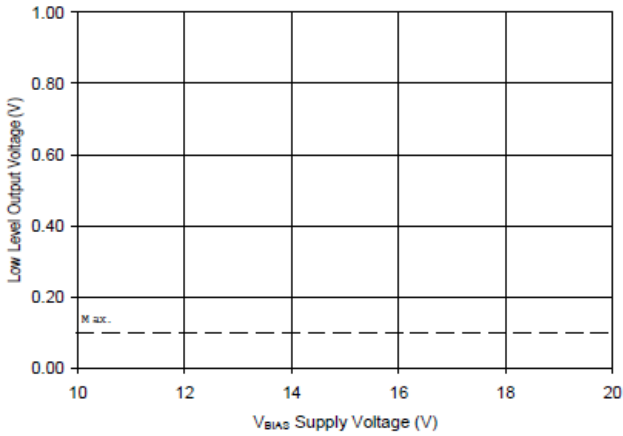
**Figure 12A. High Level Output vs. Temperature**



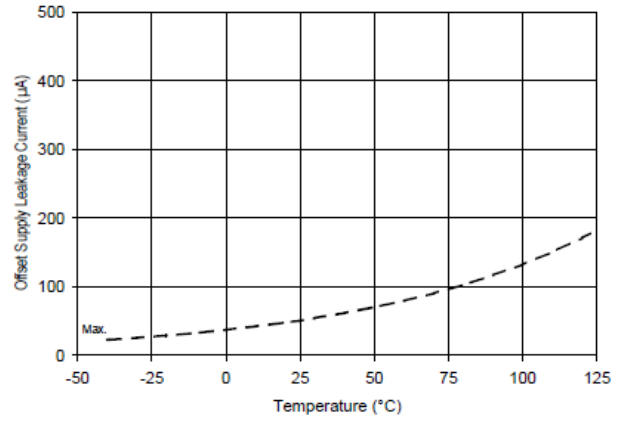
**Figure 12B. High Level Output vs. Voltage**



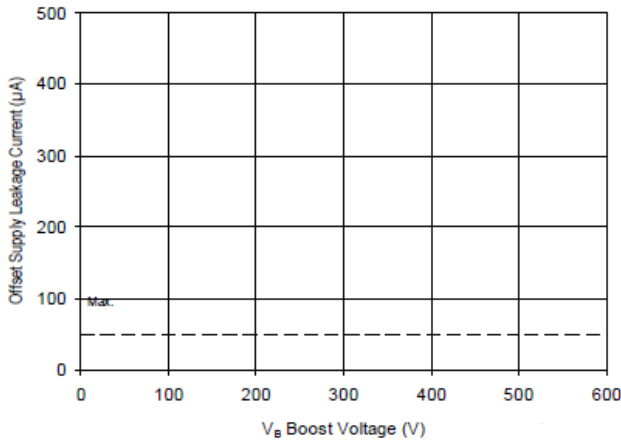
**Figure 13A. Low Level Output vs. Temperature**



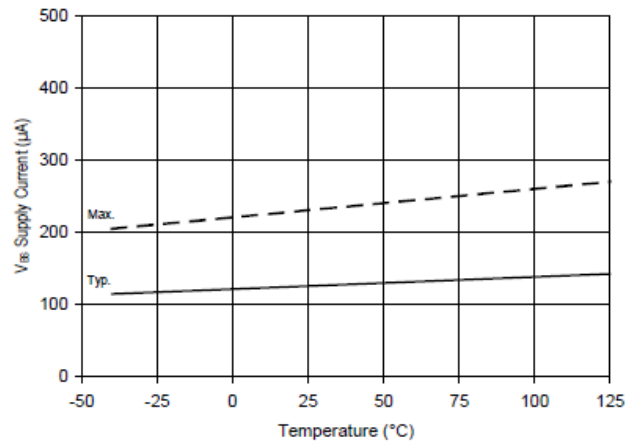
**Figure 13B. Low Level Output vs. Voltage**



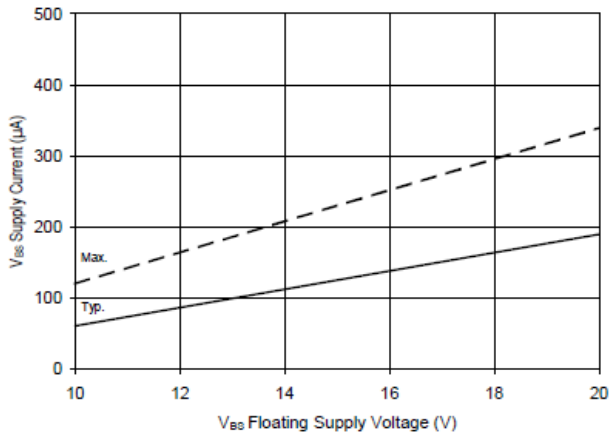
**Figure 14A. Offset Supply Current vs. Temperature**



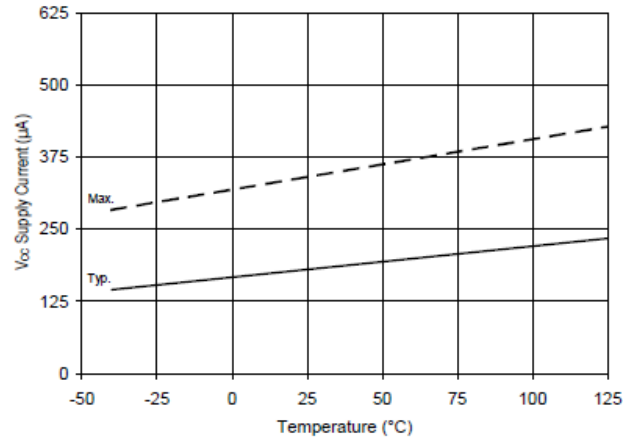
**Figure 14B. Offset Supply Current vs. Voltage**



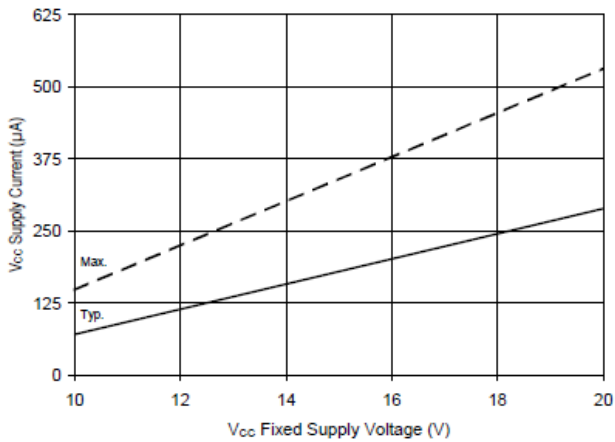
**Figure 15A. V<sub>BS</sub> Supply Current vs. Temperature**



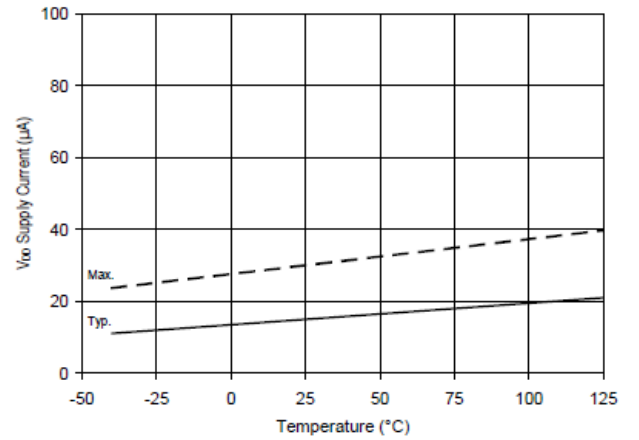
**Figure 15B. V<sub>BS</sub> Supply Current vs. Voltage**



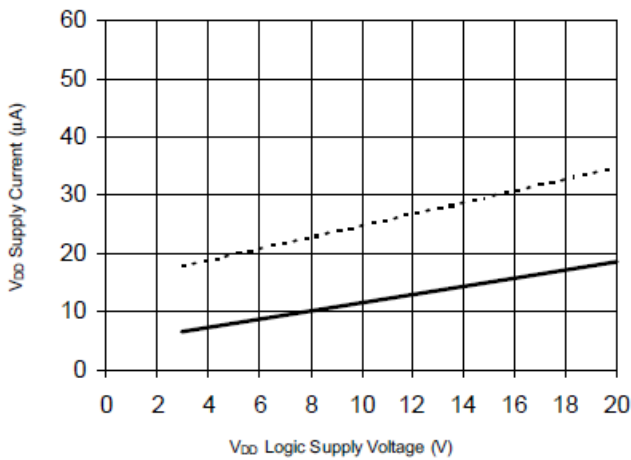
**Figure 16A. V<sub>CC</sub> Supply Current vs. Temperature**



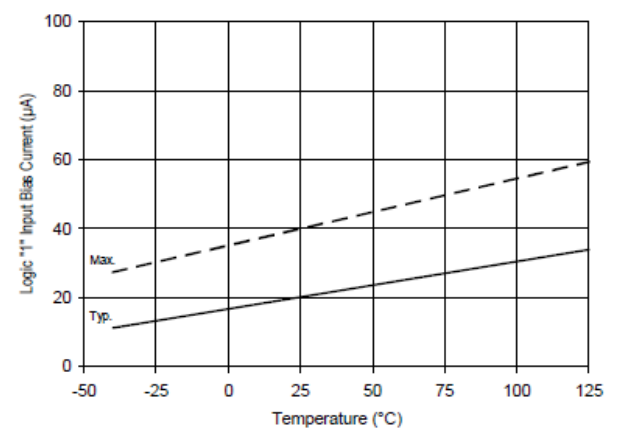
**Figure 16B. V<sub>CC</sub> Supply Current vs. Voltage**



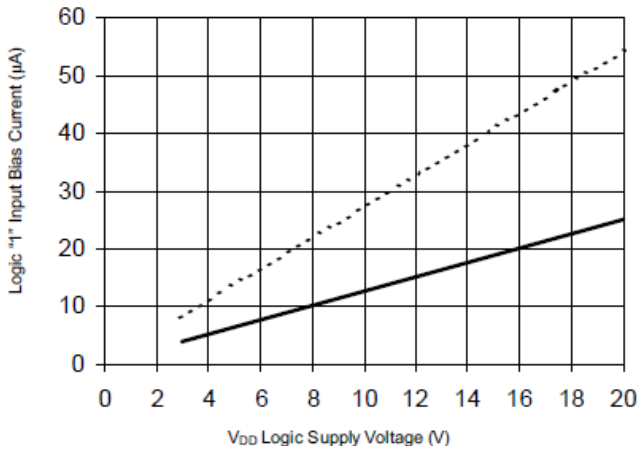
**Figure 17A. V<sub>DD</sub> Supply Current vs. Temperature**



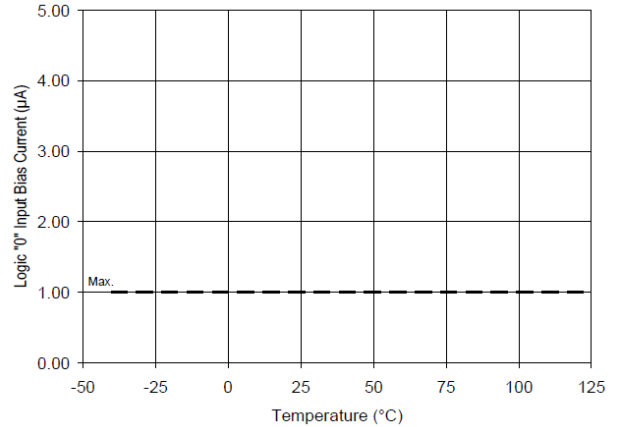
**Figure 17B. V<sub>DD</sub> Supply Current vs. V<sub>DD</sub> Voltage**



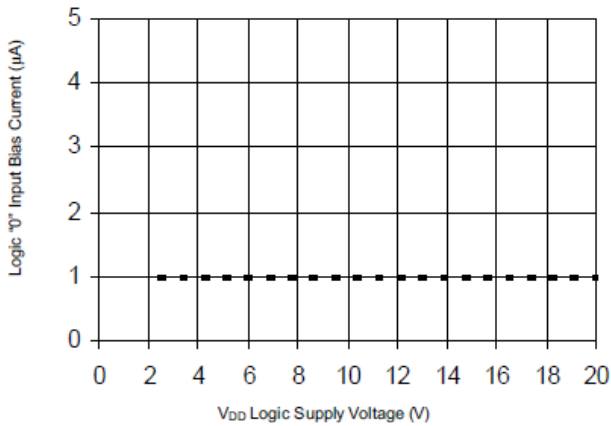
**Figure 18A. Logic '1' Input Current vs. Temperature**



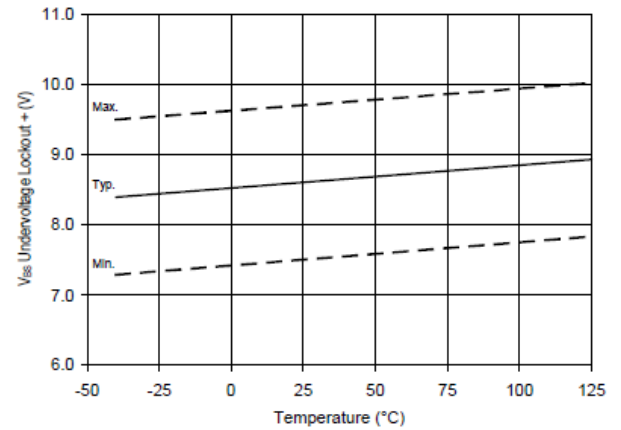
**Figure 18B. Logic '1' Input Current vs. V<sub>DD</sub> Voltage**



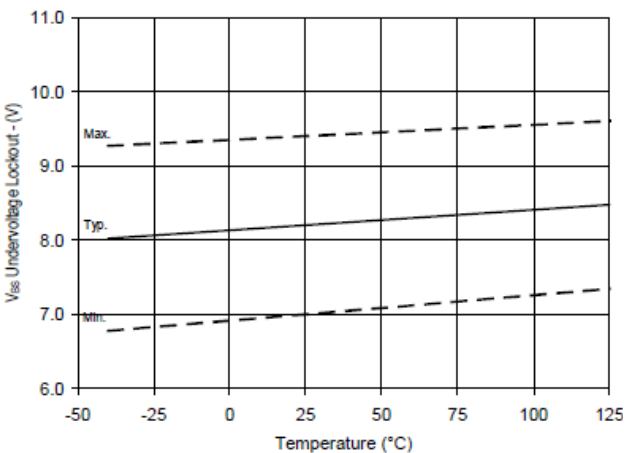
**Figure 19A. Logic '0' Input Current vs. Temperature**



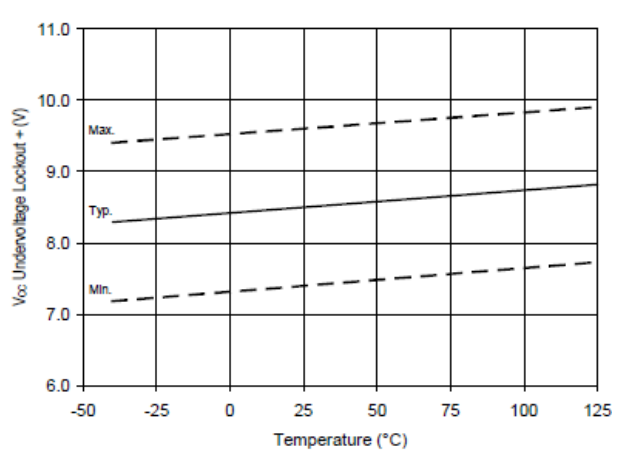
**Figure 19B. Logic '0' Input Current vs. V<sub>DD</sub> Voltage**



**Figure 20. V<sub>BS</sub> Undervoltage (+) vs. Temperature**



**Figure 21 V<sub>BS</sub> Undervoltage (-) vs. Temperature**



**Figure 22. V<sub>CC</sub> Undervoltage (+) vs. Temperature**

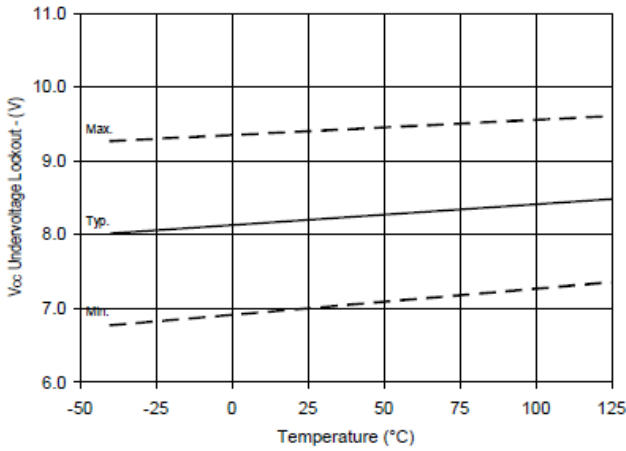


Figure 23.  $V_{CC}$  Undervoltage (-) vs. Temperature

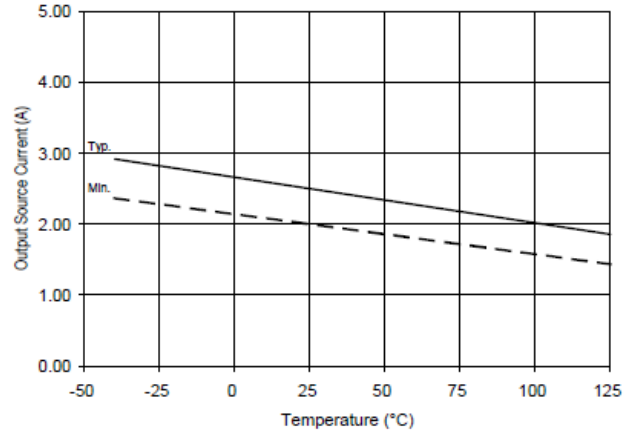


Figure 24A. Output Source Current vs. Temperature

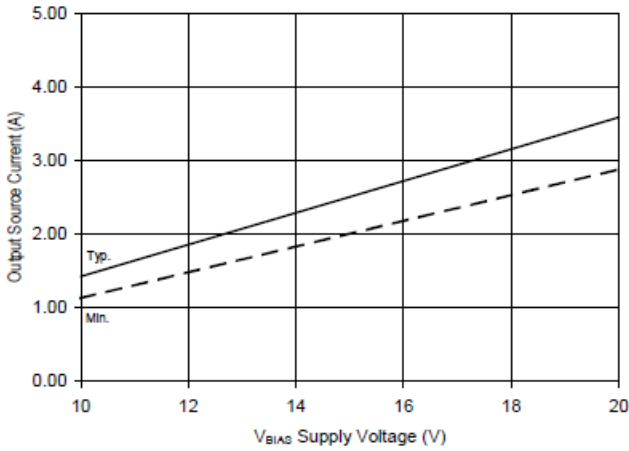


Figure 24B. Output Source Current vs. Voltage

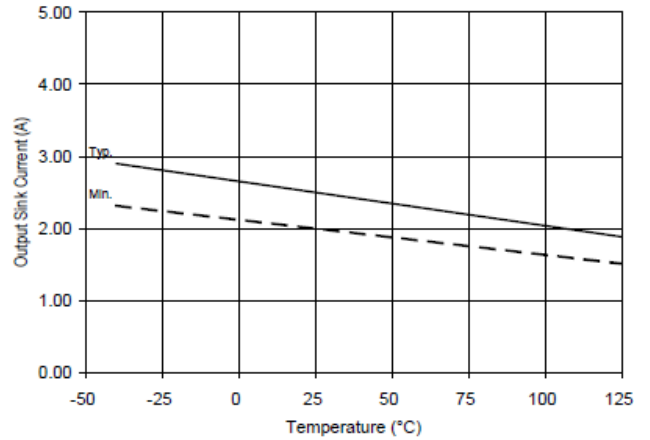


Figure 25A. Output Sink Current vs. Temperature

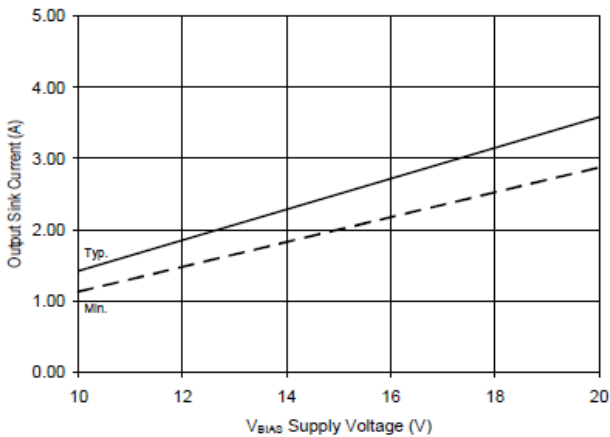


Figure 25B. Output Sink Current vs. Voltage

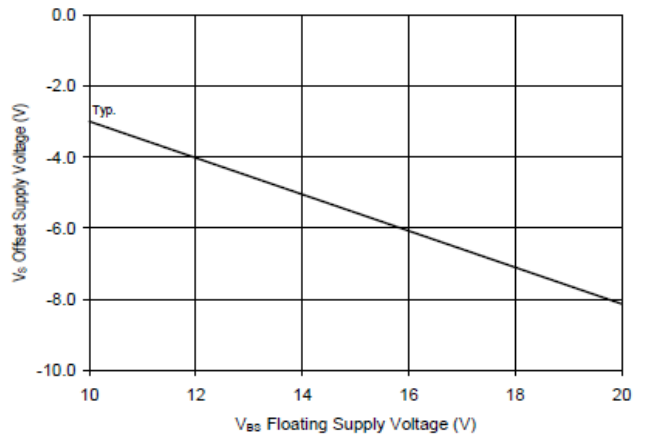
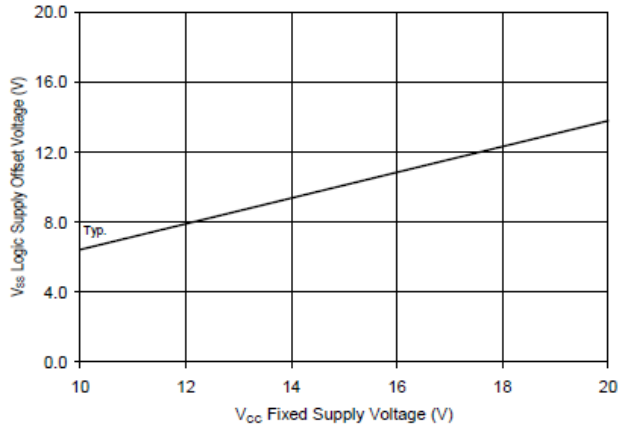
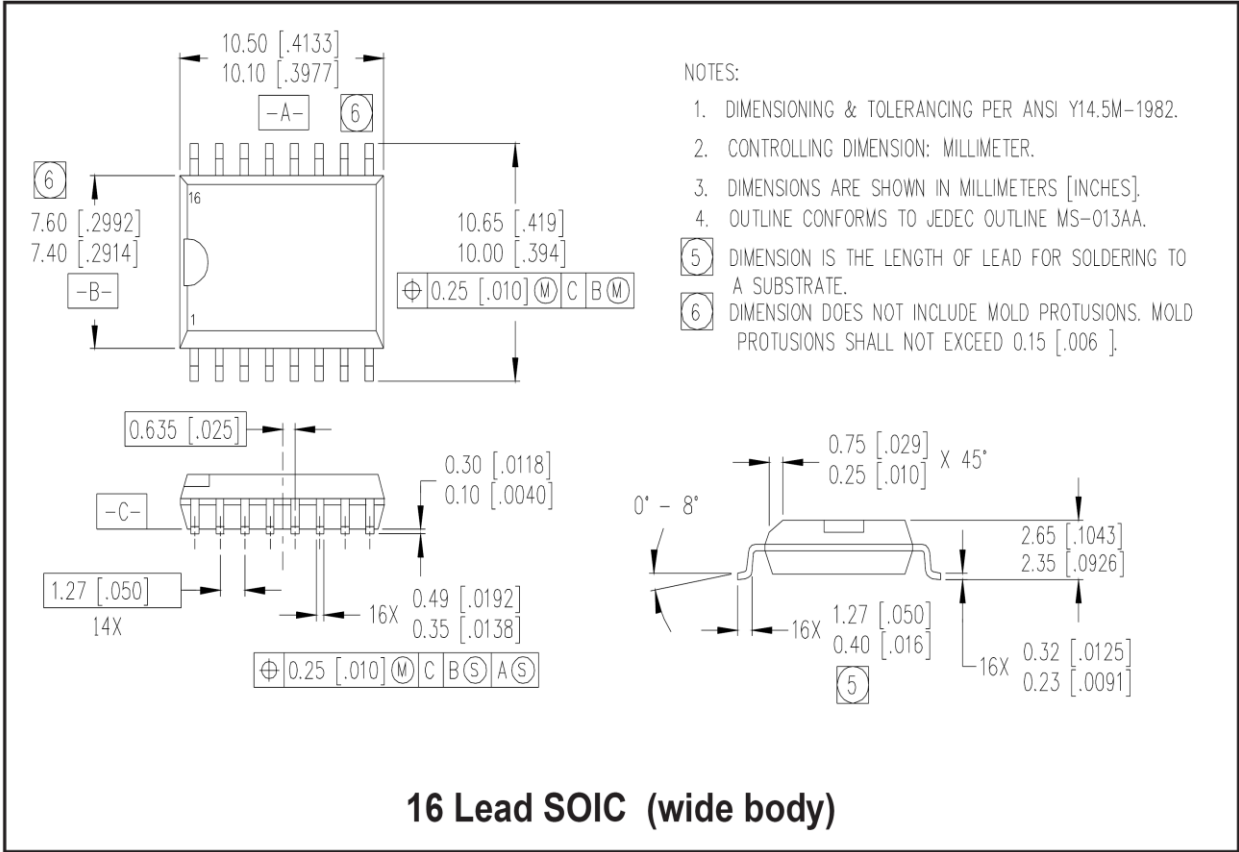


Figure 26. Maximum  $V_S$  Negative Offset vs.  $V_{BS}$  Supply Voltage



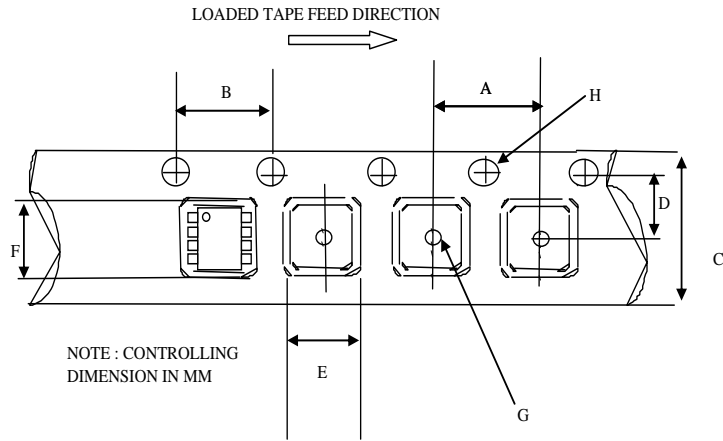
**Figure 27. Maximum V<sub>SS</sub> Positive Offset vs. V<sub>CC</sub> Supply Voltage**

**Package Details**



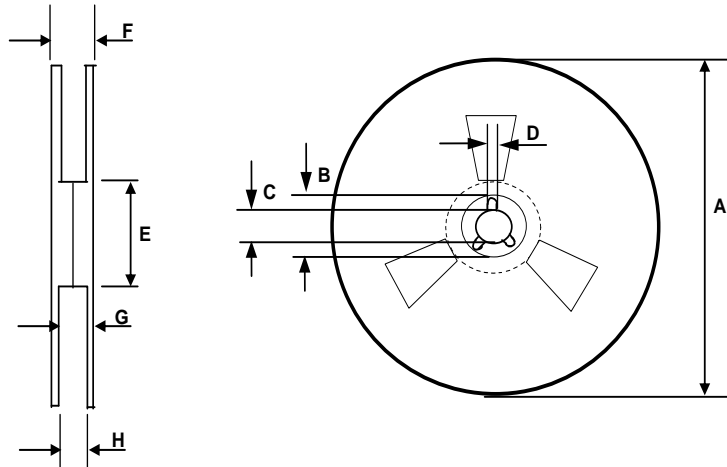


## Tape and Reel Details



CARRIER TAPE DIMENSION FOR 16SOICN

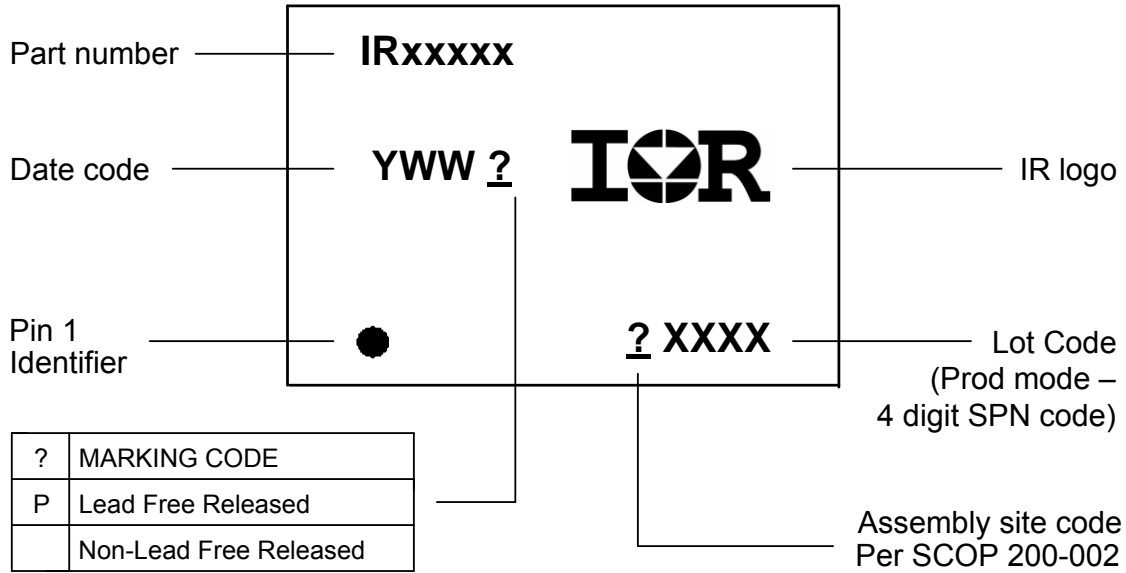
Code	Metric		Imperial	
	Min	Max	Min	Max
A	7.90	8.10	0.311	0.318
B	3.90	4.10	0.153	0.161
C	15.70	16.30	0.618	0.641
D	7.40	7.60	0.291	0.299
E	6.40	6.60	0.252	0.260
F	10.20	10.40	0.402	0.409
G	1.50	n/a	0.059	n/a
H	1.50	1.60	0.059	0.062



REEL DIMENSIONS FOR 16SOICN

Code	Metric		Imperial	
	Min	Max	Min	Max
A	329.60	330.25	12.976	13.001
B	20.95	21.45	0.824	0.844
C	12.80	13.20	0.503	0.519
D	1.95	2.45	0.767	0.096
E	98.00	102.00	3.858	4.015
F	n/a	22.40	n/a	0.881
G	18.50	21.10	0.728	0.830
H	16.40	18.40	0.645	0.724

**Part Marking Information**



**Qualification Information<sup>†</sup>**

<b>Qualification Level</b>	Industrial <sup>††</sup> (per JEDEC JESD 47)
	Comments: This family of ICs has passed JEDEC's Industrial qualification. IR's Consumer qualification level is granted by extension of the higher Industrial level.
<b>Moisture Sensitivity Level</b>	MSL3 <sup>†††</sup> (per IPC/JEDEC J-STD-020)
<b>RoHS Compliant</b>	Yes

† Qualification standards can be found at International Rectifier's web site <http://www.irf.com/>

†† Higher qualification ratings may be available should the user have such requirements. Please contact your International Rectifier sales representative for further information.

††† Higher MSL ratings may be available for the specific package types listed here. Please contact your International Rectifier sales representative for further information.

The information provided in this document is believed to be accurate and reliable. However, International Rectifier assumes no responsibility for the consequences of the use of this information. International Rectifier assumes no responsibility for any infringement of patents or of other rights of third parties which may result from the use of this information. No license is granted by implication or otherwise under any patent or patent rights of International Rectifier. The specifications mentioned in this document are subject to change without notice. This document supersedes and replaces all information previously supplied.

For technical support, please contact IR's Technical Assistance Center  
<http://www.irf.com/technical-info/>

**WORLD HEADQUARTERS:**  
 233 Kansas St., El Segundo, California 90245  
 Tel: (310) 252-7105