

# NCP4423, NCP4424, NCP4425



ON Semiconductor®

<http://onsemi.com>

## 3 A Dual High-Speed MOSFET Drivers

The NCP4423/4424/4425 are MOSFET drivers that are capable of giving reliable service in demanding electrical environments.

Although primarily intended for driving power MOSFETs, these drivers are well-suited for driving other loads (capacitive, resistive, or inductive) which require a low impedance driver capable of high peak currents and fast switching times. Applications such as heavily loaded clock lines, coaxial cables, or piezoelectric transducers can all be driven with the NCP4423/4424/4425. The only known limitation on loading is that the total power dissipated of the driver must be kept within the maximum power dissipation limits of the package.

### Features

- High Peak Output Current (3 A)
- Wide Operating Range (4.5 V to 18 V)
- High Capacitive Load Drive Capability (1800 pF in 25 nsec)
- Short Delay Times (< 40 nsec Typ)
- Matched Rise/Fall Times
- Low Supply Current
  - With Logic "1" Input (3.5 mA)
  - With Logic "0" Input (350  $\mu$ A)
- Low Output Impedance (3.5  $\Omega$  Typ)
- Latch-Up Protected: Will Withstand 1.5 A Reverse Current
- Logic Input Will Withstand Negative Swing Up to 5 V
- ESD Protected (4 kV)

### MARKING DIAGRAM

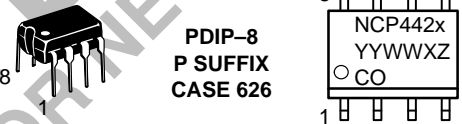

x = Device Number (3, 4, or 5)  
 YY = Year  
 WW = Work Week  
 X = Assembly ID Code  
 Z = Subcontractor ID Code  
 CO = Country of Origin

### ORDERING INFORMATION

Device	Package	Shipping
NCP4423DWR2	SO-16	1000 Tape & Reel
NCP4424DWR2	SO-16	1000 Tape & Reel
NCP4425DWR2	SO-16	1000 Tape & Reel
NCP4423P	PDIP-8	50 Units/Rail
NCP4424P	PDIP-8	50 Units/Rail
NCP4425P	PDIP-8	50 Units/Rail

### FUNCTIONAL BLOCK DIAGRAM

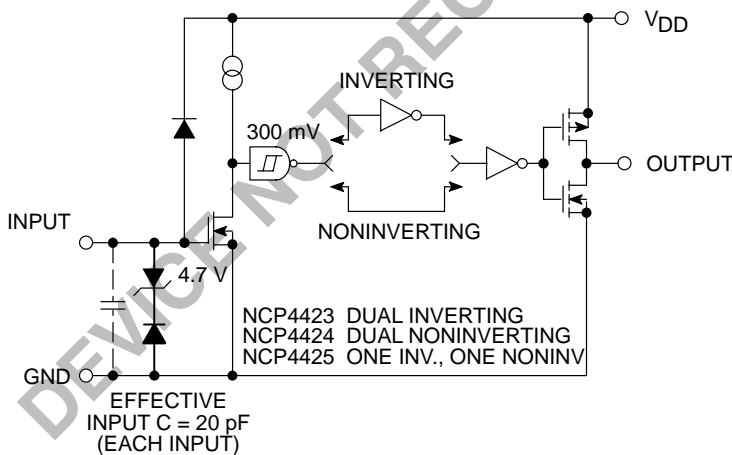

#### NOTES:

1. NCP4425 has one inverting and one noninverting driver.
2. Ground any unused driver input.

# NCP4423, NCP4424, NCP4425

## PIN CONNECTIONS

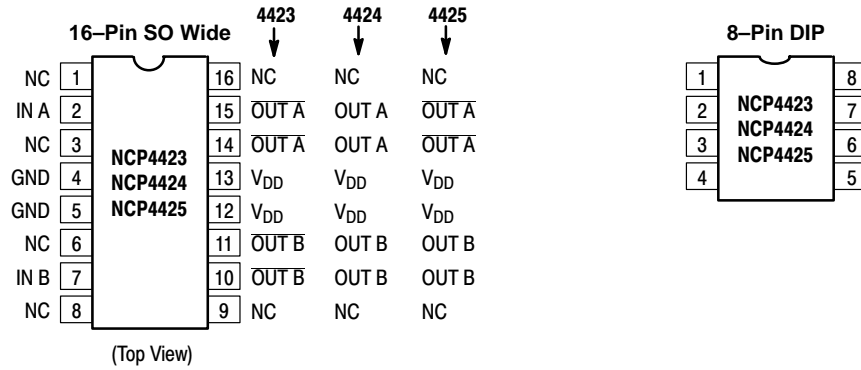

**NC = NO CONNECTION**

**NOTE:** Duplicate pins must **both** be connected for proper operation.

ARCHIVE

DEVICE NOT RECOMMENDED FOR NEW DESIGN

# NCP4423, NCP4424, NCP4425

## ABSOLUTE MAXIMUM RATINGS

Rating	Value	Unit
Supply Voltage	+22	V
Input Voltage, IN A or IN B ( $V_{DD} + 0.3$ V to GND – 5.0 V)	–5	V
Maximum Chip Temperature	+150	°C
Storage Temperature Range, $T_{stg}$	–65 to +150	°C
Lead Temperature (Soldering, 10 sec)	+300	°C
Package Thermal Resistance SOIC, $R_{\theta JA}$ PDIP, $R_{\theta JA}$ PDIP, $R_{\theta JC}$	155 –125 –45	°C/W
Operating Temperature Range	–40 to +85	°C
Package Power Dissipation ( $T_A \leq 70^\circ\text{C}$ ) SOIC PDIP	470 730	mW mc

## ELECTRICAL CHARACTERISTICS ( $T_A = +25^\circ\text{C}$ with $4.5\text{ V} \leq V_{DD} \leq 18\text{ V}$ , unless otherwise specified.)

Characteristic	Symbol	Test Conditions	Min	Typ	Max	Unit
<b>Input</b>						
Logic 1 High Input Voltage	$V_{OH}$	–	2.4	–	–	V
Logic 0 Low Input Voltage	$V_{IL}$	–	–	–	0.8	V
Input Current	$I_{IN}$	$0\text{ V} \leq V_{IN} \leq V_{DD}$	–1.0	–	1.0	$\mu\text{A}$
<b>Output</b>						
High Output Voltage	$V_{OH}$	–	$V_{DD} - 0.025$	–	–	V
Low Output Voltage	$V_{OL}$	–	–	–	0.025	V
Output Resistance, High	$R_{OH}$	$I_{OUT} = 10\text{ mA}$ , $V_{DD} = 18\text{ V}$	–	2.8	5.0	$\Omega$
Output Resistance, Low	$R_{OL}$	$I_{OUT} = 10\text{ mA}$ , $V_{DD} = 18\text{ V}$	–	3.5	5.0	$\Omega$
Peak Output Current	$I_{PK}$	–	–	3.0	–	A
Latch-Up Protection Withstand Reverse Current	$I_{REV}$	Duty Cycle $\leq 2\%$ $t \leq 300\ \mu\text{s}$	1.5	–	–	A
<b>Switching Time (Note 1)</b>						
Rise Time	$t_R$	Figure 1, $C_L = 1800\text{ pF}$	–	23	35	nsec
Fall Time	$t_F$	Figure 1, $C_L = 1800\text{ pF}$	–	25	35	nsec
Delay Time 1	$t_{D1}$	Figure 1, $C_L = 1800\text{ pF}$	–	33	75	nsec
Delay Time 2	$t_{D2}$	Figure 1, $C_L = 1800\text{ pF}$	–	38	75	nsec
<b>Power Supply</b>						
Power Supply Current	$I_S$	$V_{IN} = 3.0\text{ V}$ (Both Inputs) $V_{IN} = 0\text{ V}$ (Both Inputs)	– –	1.5 0.15	2.5 0.25	mA

1. Switching times guaranteed by design.

# NCP4423, NCP4424, NCP4425

**ELECTRICAL CHARACTERISTICS** (Over operating temperature range with  $4.5\text{ V} \leq V_{DD} \leq 18\text{ V}$ , unless otherwise specified.)

Characteristic	Symbol	Test Conditions	Min	Typ	Max	Unit
----------------	--------	-----------------	-----	-----	-----	------

**Input**

Logic 1 High Input Voltage	$V_{IH}$	–	2.4	–	–	V
Logic 0 Low Input Voltage	$V_{IL}$	–	–	–	0.8	V
Input Current	$I_{IN}$	$0\text{ V} \leq V_{IN} \leq V_{DD}$	–10	–	10	$\mu\text{A}$

**Output**

High Output Voltage	$V_{OH}$	–	$V_{DD} - 0.025$	–	–	V
Low Output Voltage	$V_{OL}$	–	–	–	0.025	V
Output Resistance, High	$R_O$	$I_{OUT} = 10\text{ mA}$ , $V_{DD} = 18\text{ V}$	–	3.7	8.0	$\Omega$
Output Resistance, Low	$R_O$	$I_{OUT} = 10\text{ mA}$ , $V_{DD} = 18\text{ V}$	–	4.3	8.0	$\Omega$
Peak Output Current	$I_{PK}$	–	–	3.0	–	A
Latch-Up Protection Withstand Reverse Current	$I_{REV}$	Duty Cycle $\leq 2\%$ $t \leq 300\ \mu\text{sec}$	1.5	–	–	A

**Switching Time (Note 1)**

Rise Time	$t_R$	Figure 1, $C_L = 1800\text{ pF}$	–	28	60	nsec
Fall Time	$t_F$	Figure 1, $C_L = 1800\text{ pF}$	–	32	60	nsec
Delay Time 1	$t_{D1}$	Figure 1, $C_L = 1800\text{ pF}$	–	32	100	nsec
Delay Time 2	$t_{D2}$	Figure 1, $C_L = 1800\text{ pF}$	–	38	100	nsec

**Power Supply**

Power Supply Current	$I_S$	$V_{IN} = 3.0\text{ V}$ (Both Inputs) $V_{IN} = 0\text{ V}$ (Both Inputs)	–	2.0	3.5	mA
----------------------	-------	--	---	-----	-----	----

1. Switching times guaranteed by design.

Test Circuit

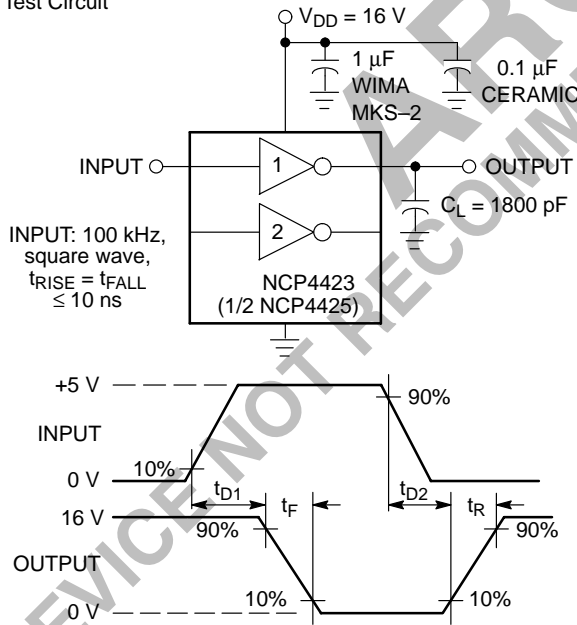

Figure 1. Inverting Driver Switching Time

Test Circuit

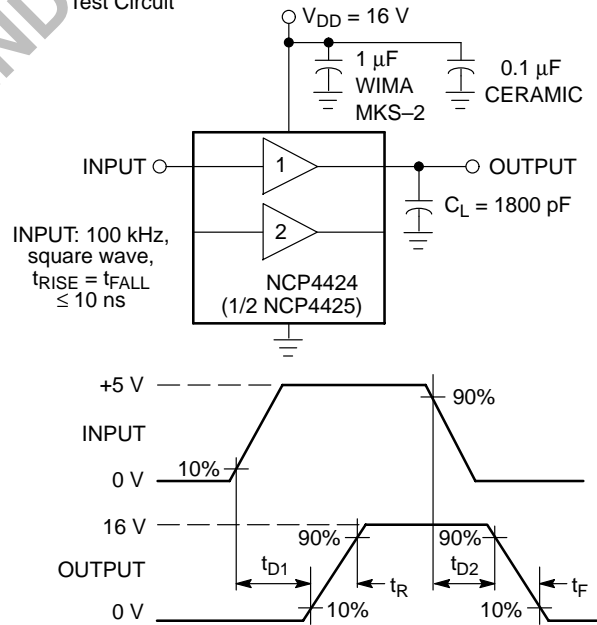

Figure 2. Noninverting Driver Switching Time

TYPICAL ELECTRICAL CHARACTERISTICS

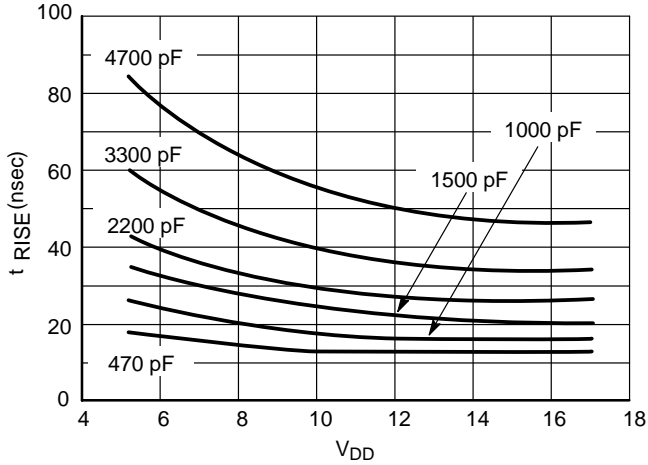

Figure 3. Rise Time vs. Supply Voltage

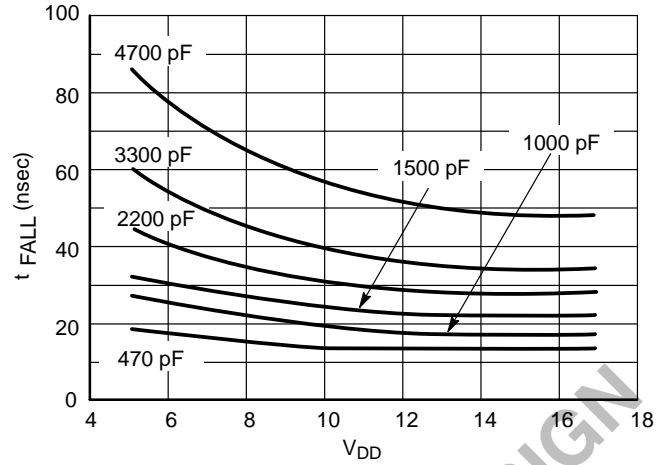

Figure 4. Fall Time vs. Supply Voltage

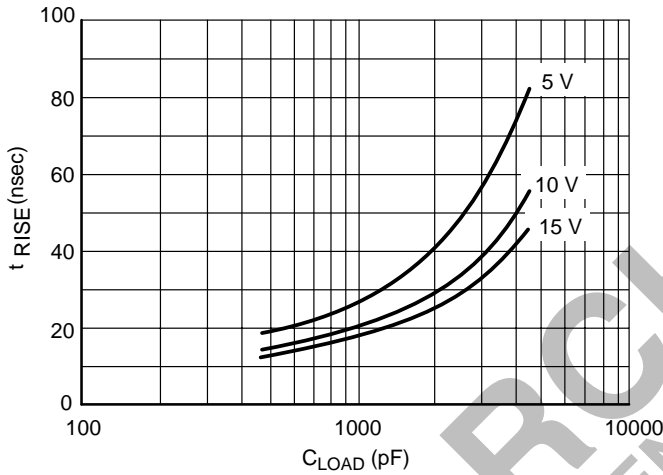

Figure 5. Rise Time vs. Capacitive Load

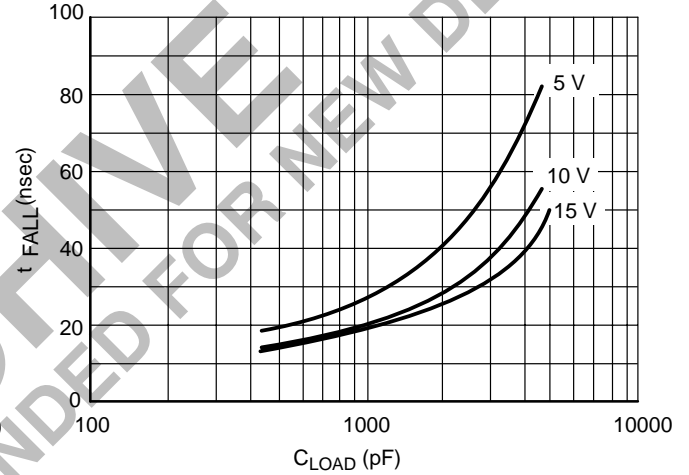

Figure 6. Fall Time vs. Capacitive Load

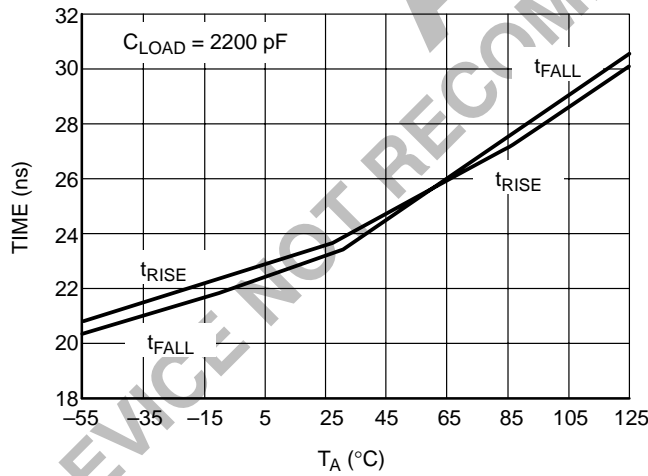

Figure 7. Rise and Fall Times vs. Temperature

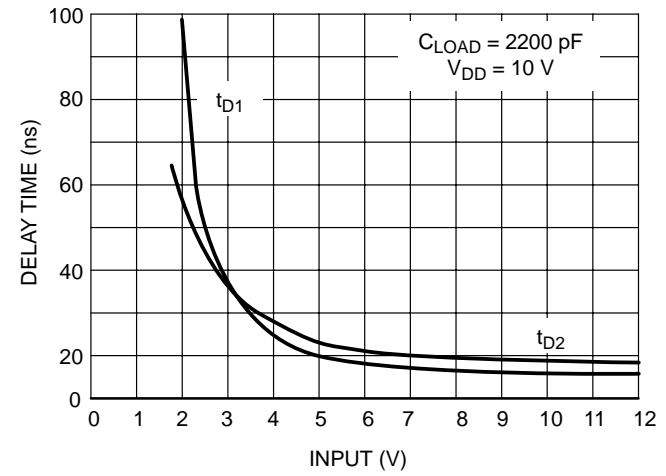

Figure 8. Propagation Delay vs. Input Amplitude

TYPICAL ELECTRICAL CHARACTERISTICS

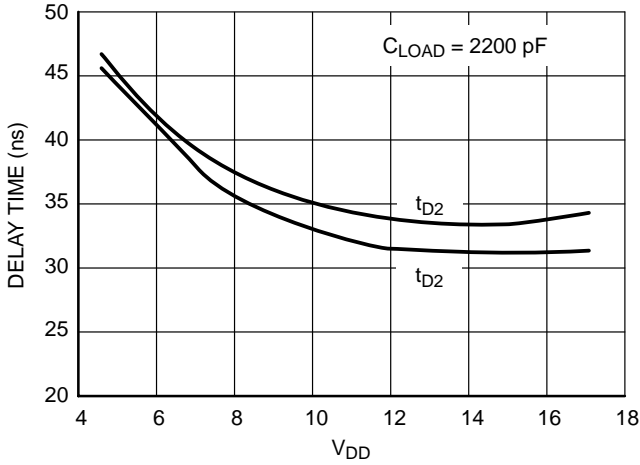

Figure 9. Propagation Delay Time vs. Supply Voltage

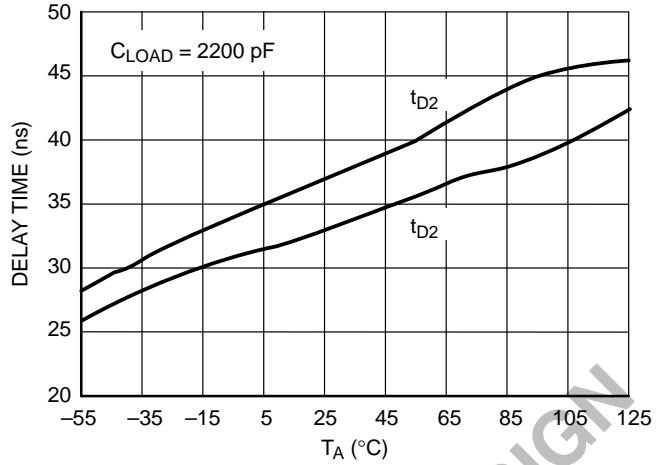

Figure 10. Delay Time vs. Temperature

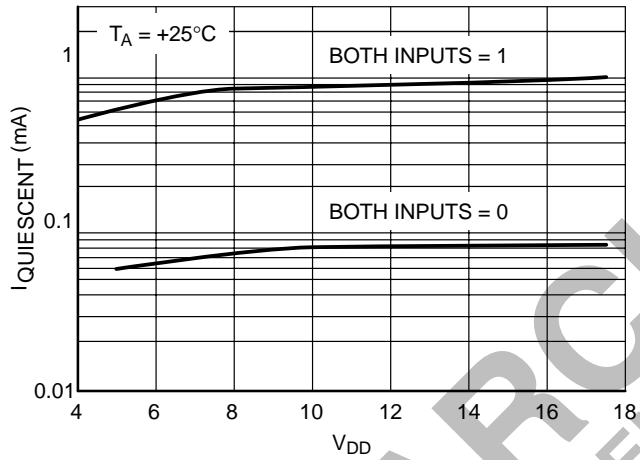

Figure 11. Quiescent Current vs. Supply Voltage

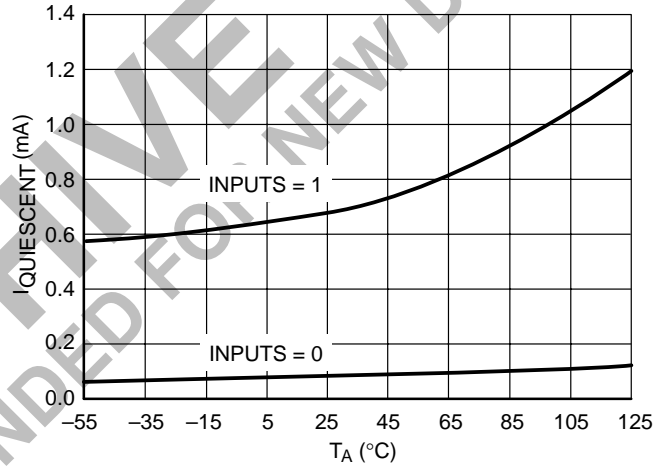

Figure 12. Quiescent Current vs. Temperature

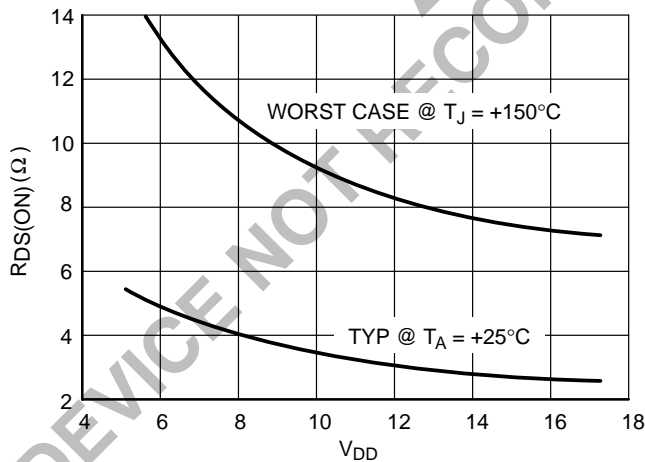

Figure 13. Output Resistance (Output High) vs. Supply Voltage

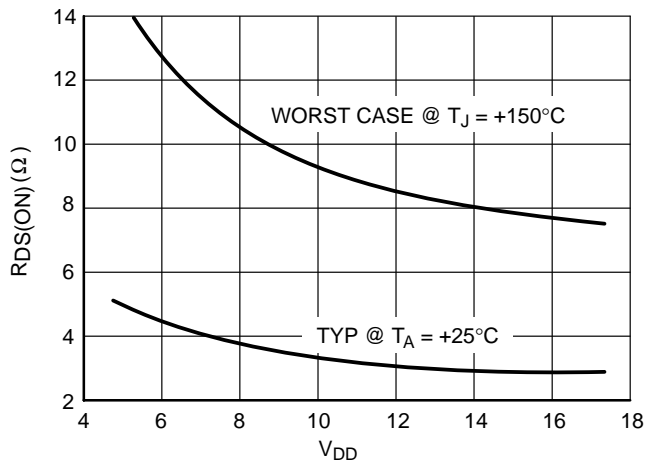

Figure 14. Output Resistance (Output Low) vs. Supply Voltage

TYPICAL ELECTRICAL CHARACTERISTICS

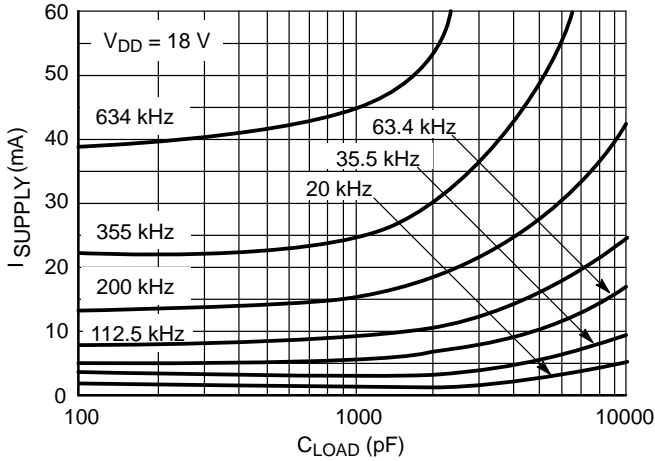

Figure 15. Supply Current vs. Capacitive Load

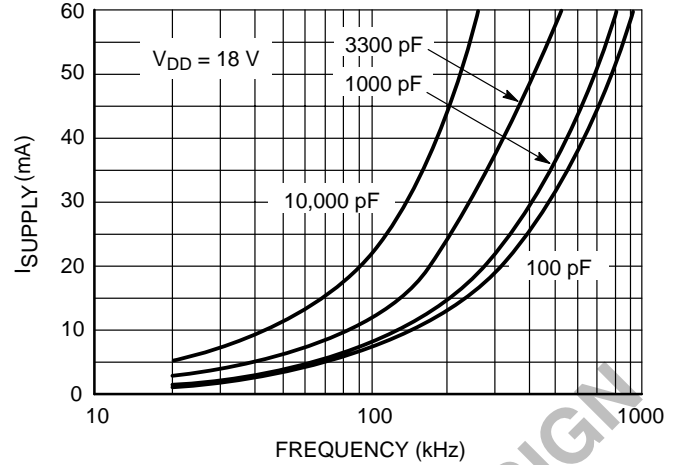

Figure 16. Supply Current vs. Frequency

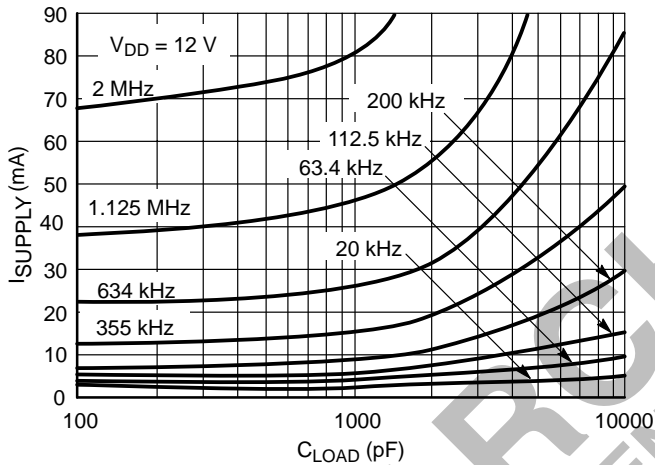

Figure 17. Supply Current vs. Capacitive Load

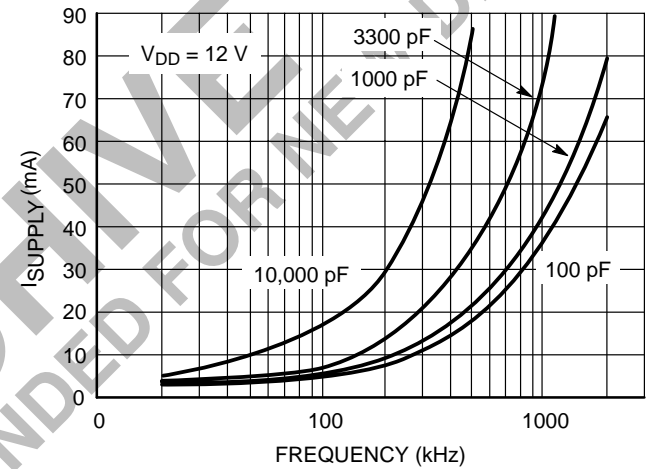

Figure 18. Supply Current vs. Frequency

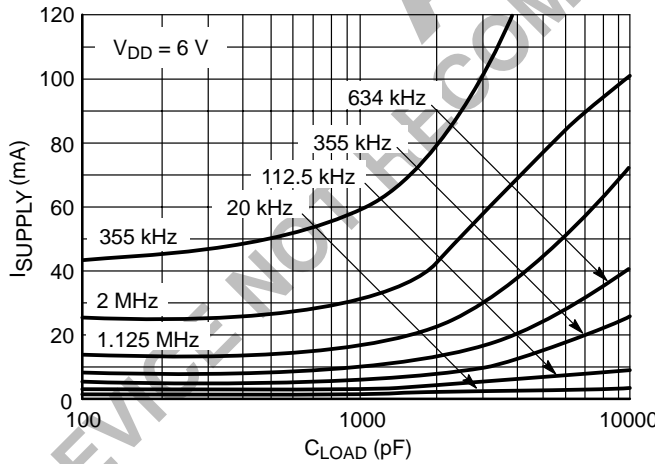

Figure 19. Supply Current vs. Capacitive Load

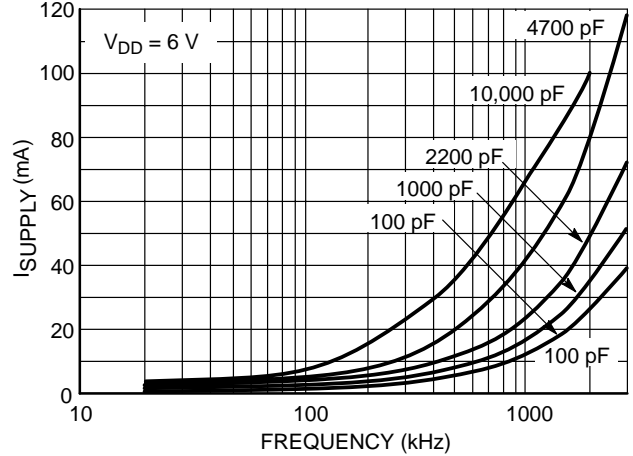

Figure 20. Supply Current vs. Frequency

TYPICAL ELECTRICAL CHARACTERISTICS

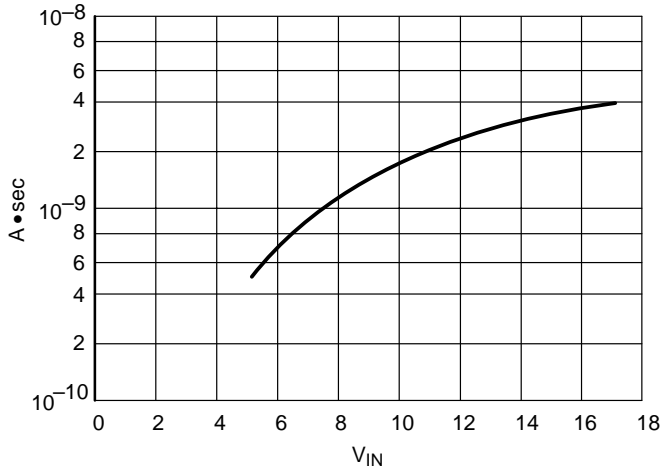

Figure 21. NCP4423 Crossover Energy

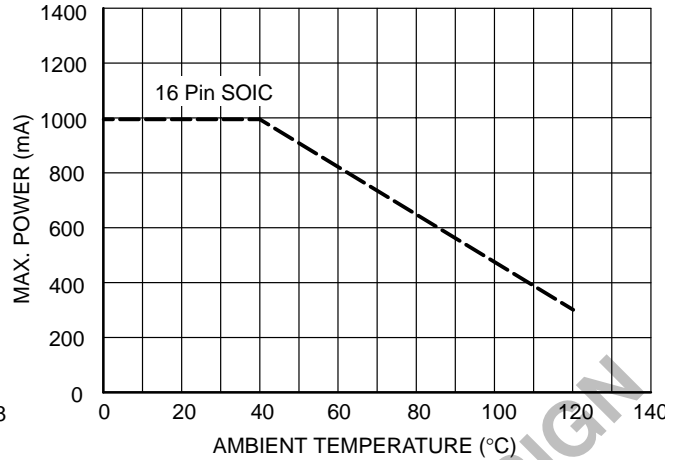

Figure 22. Thermal Derating Curves

NOTE: The values on this graph represent the loss seen by both drivers in a package during one complete cycle. For a single driver, divide the stated values by 2. For a single transition of a single driver, divide the stated value by 4.

Static-sensitive device. Unused devices must be stored in conductive material. Protect devices from static discharge and static fields. Stresses above those listed under Absolute Maximum Ratings (See page 2) may cause permanent damage to the device. These are stress ratings only and functional operation of the device at these or any other conditions above those indicated in the operational sections of the specifications is not implied. Exposure to Absolute Maximum Rating Conditions for extended periods may affect device reliability.

ARCHIVE  
DEVICE NOT RECOMMENDED FOR NEW DESIGN



# NCP4423, NCP4424, NCP4425

## PACKAGE DIMENSIONS

PDIP-8  
P SUFFIX  
CASE 626-05  
ISSUE K

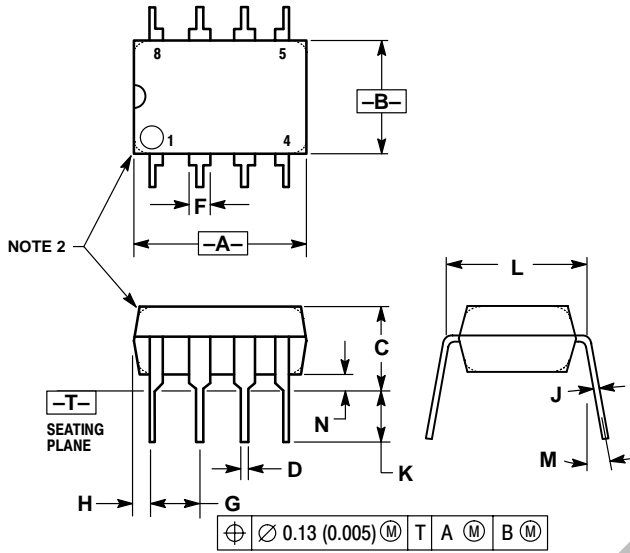

NOTES:

1. DIMENSION L TO CENTER OF LEAD WHEN FORMED PARALLEL.
2. PACKAGE CONTOUR OPTIONAL (ROUND OR SQUARE CORNERS).
3. DIMENSIONING AND TOLERANCING PER ANSI Y14.5M, 1982.

DIM	MILLIMETERS		INCHES	
	MIN	MAX	MIN	MAX
A	9.40	10.16	0.370	0.400
B	6.10	6.60	0.240	0.260
C	3.94	4.45	0.155	0.175
D	0.38	0.51	0.015	0.020
F	1.02	1.78	0.040	0.070
G	2.54 BSC		0.100 BSC	
H	0.76	1.27	0.030	0.050
J	0.20	0.30	0.008	0.012
K	2.92	3.43	0.115	0.135
L	7.62 BSC		0.300 BSC	
M	---	10°	---	10°
N	0.76	1.01	0.030	0.040

SO-16  
DW SUFFIX  
CASE 751G-03  
ISSUE B

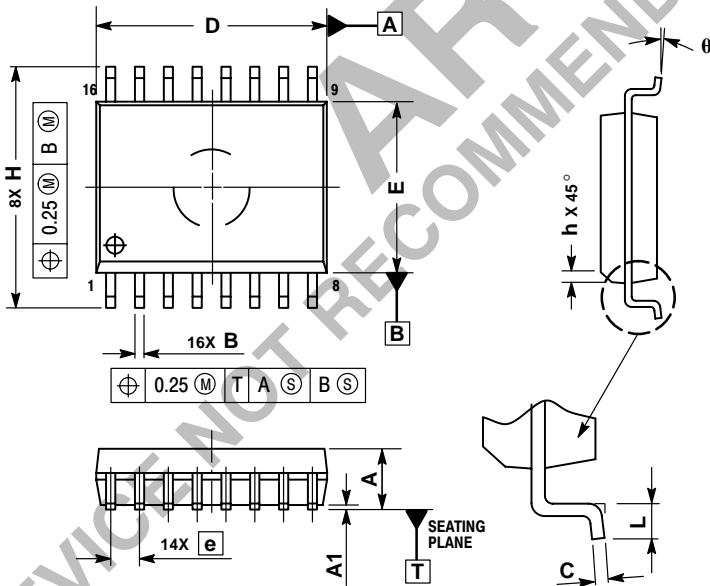

NOTES:

1. DIMENSIONS ARE IN MILLIMETERS.
2. INTERPRET DIMENSIONS AND TOLERANCES PER ASME Y14.5M, 1994.
3. DIMENSIONS D AND E DO NOT INCLUDE MOLD PROTRUSION.
4. MAXIMUM MOLD PROTRUSION 0.15 PER SIDE.
5. DIMENSION B DOES NOT INCLUDE DAMBAR PROTRUSION. ALLOWABLE DAMBAR PROTRUSION SHALL BE 0.13 TOTAL IN EXCESS OF THE B DIMENSION AT MAXIMUM MATERIAL CONDITION.

DIM	MILLIMETERS	
	MIN	MAX
A	2.35	2.65
A1	0.10	0.25
B	0.35	0.49
C	0.23	0.32
D	10.15	10.45
E	7.40	7.60
e	1.27 BSC	
H	10.05	10.55
h	0.25	0.75
L	0.50	0.90
θ	0°	7°

**Notes**

ARCHIVE  
DEVICE NOT RECOMMENDED FOR NEW DESIGN

**Notes**

**ARCHIVE**  
DEVICE NOT RECOMMENDED FOR NEW DESIGN

ARCHIVE  
RECOMMENDED FOR NEW DESIGN

**ON Semiconductor** and  are registered trademarks of Semiconductor Components Industries, LLC (SCILLC). SCILLC reserves the right to make changes without further notice to any products herein. SCILLC makes no warranty, representation or guarantee regarding the suitability of its products for any particular purpose, nor does SCILLC assume any liability arising out of the application or use of any product or circuit, and specifically disclaims any and all liability, including without limitation special, consequential or incidental damages. "Typical" parameters which may be provided in SCILLC data sheets and/or specifications can and do vary in different applications and actual performance may vary over time. All operating parameters, including "Typicals" must be validated for each customer application by customer's technical experts. SCILLC does not convey any license under its patent rights nor the rights of others. SCILLC products are not designed, intended, or authorized for use as components in systems intended for surgical implant into the body, or other applications intended to support or sustain life, or for any other application in which the failure of the SCILLC product could create a situation where personal injury or death may occur. Should Buyer purchase or use SCILLC products for any such unintended or unauthorized application, Buyer shall indemnify and hold SCILLC and its officers, employees, subsidiaries, affiliates, and distributors harmless against all claims, costs, damages, and expenses, and reasonable attorney fees arising out of, directly or indirectly, any claim of personal injury or death associated with such unintended or unauthorized use, even if such claim alleges that SCILLC was negligent regarding the design or manufacture of the part. SCILLC is an Equal Opportunity/Affirmative Action Employer.

## PUBLICATION ORDERING INFORMATION

### Literature Fulfillment:

Literature Distribution Center for ON Semiconductor  
P.O. Box 5163, Denver, Colorado 80217 USA  
**Phone:** 303-675-2175 or 800-344-3860 Toll Free USA/Canada  
**Fax:** 303-675-2176 or 800-344-3867 Toll Free USA/Canada  
**Email:** ONlit@hibbertco.com

**N. American Technical Support:** 800-282-9855 Toll Free USA/Canada

**JAPAN:** ON Semiconductor, Japan Customer Focus Center  
2-9-1 Kamimeguro, Meguro-ku, Tokyo, Japan 153-0051  
**Phone:** 81-3-5773-3850  
**Email:** r14525@onsemi.com

**ON Semiconductor Website:** <http://onsemi.com>

For additional information, please contact your local Sales Representative.